

B+K PRECISION PRODUCT CATALOG

test instruments and accessories



professionals > engineers > designers > students > technicians > service professionals

B+K

BK PRECISION
ELECTRONIC TEST INSTRUMENTS

20MHz DDS Sweep Function Generator Model 4045



www.bkprecision.com

The B+K website answers the important questions:

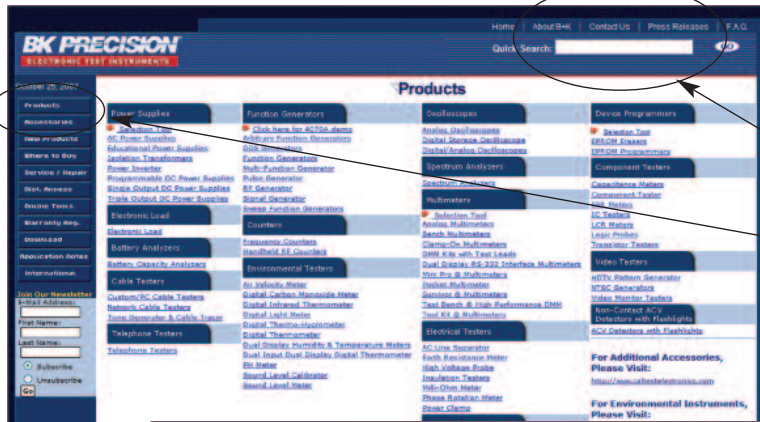

1. Do we have a product that meets your needs?

Enter a model number in the **Quick Search** box for a detailed product display page or Click on a sub category from the **Product** page.

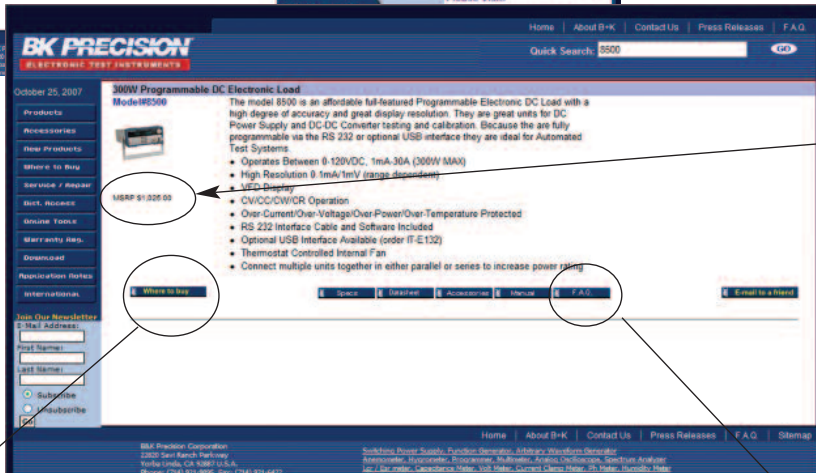

2. Priced within your budget?

B+K lists Manufacturer's Suggested Retail Price(MSRP) for all products.

3. Where can you purchase today?

If you click the "where to buy" icon on the detail product display page, all distributors with stock will be displayed. You may go directly to that distributor website or request a quote without leaving the B+K website.

Part Number Search Results For B & K Precision

Your Search For Part No. 8500 resulted in 2 matches.

Part No.	Qty	Inv date	To Stock At	Phone	Fax	Email	RPQ	RD/MSRP
8500	2	10/25/2007	THEE EQUIPMENT SUP. STORES INC	408/979-4190	408/970-4105	thee@thee.com	RPQ	DI
8500	4	10/23/2007	WELL ELECTRONICS INC	202/292-2787	202/793-9839	well@well.com	RPQ	WHS
8500	2	10/23/2007	COOL KEY	218/951-6574	218/951-3390	coolkey@coolkey.com	RPQ	SHR
8500	2	10/23/2007	INDUSTR ELECTRONICS	800/244-6873	817/904-2889	indus@indus.com	RPQ	DI
8500	6	10/23/2007	SEARCH INC	800/408-8484	818/228-2587	search@search.com	RPQ	SHR
8500	24	10/23/2007	YAMATSU INC	847/448-8228	847/717-4121	yamat@yamatsu.com	RPQ	DI
8500	4	10/23/2007	ELITE ELECTRONICS	800/225-9100	817/349-8444	elite@elite.com	RPQ	WHS
8500	1.00	10/13/2007	ELECTRONIC EXPRESS	732/378-8000	732/265-1056	ee@ee.com	RPQ	SHR
8500APPROXIMATION	4	10/23/2007	THEE EQUIPMENT SUPPLY STORES INC (NOTRIBIC)	800/979-9421	781/689-0780	thee@thee.com	RPQ	SHR

Search inventory for part numbers

Part No:

Match the starting portion of Part No
 Match the exact Part No.
 Match any portion of Part No (most comprehensive)

Powered By [Metronic Inc](#)

4. FAQ

Product specific Frequently Asked Questions (FAQ) can be accessed from the product display page.

BK PRECISION
ELECTRONIC TEST INSTRUMENTS

B+K Precision Model# 8500

How come my 8500 does not communicate with my computer?
Check the Communication Settings and make sure you have the correct Baud Rate and Address settings correct.

How do I unlock my 8500?
Use password 8512

What is the fast test time the unit can do in transient operation?
The fastest time is 2A/us.



Table of Contents

Triple Output Programmable DC Power supply Model 9130

Category	Page
Alphabetical Listings of Products	4
New Products	5
Alpha Numeric Listing of Products	6
Power Supplies	8
Electronic Load	31
Function Generators	33
Multimeters	52
Oscilloscopes	74
Spectrum Analyzers	89
RF Test Instruments	98
Frequency Counters	102
Electrical Testers	104
Battery Analyzers	108
Component Testers/Logic Probes	109
Universal Devices Programmers	117
Video Testers	121
Cable Testers	124
Telephone Testers	127
Environmental Testers	128
Accessories	140
Recorders	152

Products Easy to Find Easy to Use

25MHz Digital Storage Oscilloscope Model 2530

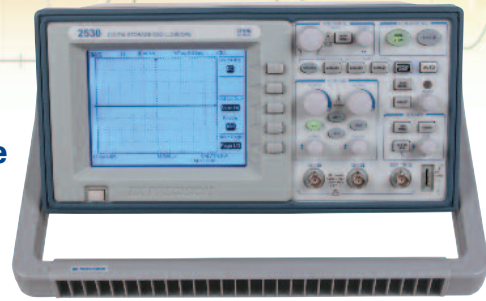

Category Index

Accessories

Carrying Cases	151
Function Generators	145, 146
General Purpose	150
Multimeters	140, 141, 142
Oscilloscopes	143, 144
Spectrum Analyzers	148, 149
Power Supplies	147

Battery Analyzers

Battery Capacity Analyzers	
Models 601, 602	108

Cable Testers

Custom/PC Cable Testers	
Models 205, 206	124
Network Cable Testers	
Models 230A, 231A	125
Tone Generator & Cable Tracer	
Model 262	126

Component Testers

Capacitance Meters	
Models 890B, 830B, 810C	112
Component Tester	
Model 815	111
ESR Meters	
Model 881	113
IC Testers	
Models 570A, 575A	114
LCR Meters	
Models 878A, 879, 875B	111
Model 885, 886	109
Model 889A	110
Logic Probes	
Models DP 21, DP 31A, DP 52	116
Transistor Testers	
Models 520C, 510A	115

Counters

Frequency Counters	
Models 1803D, 1804D, 1823A, 1856D	102, 103

Device Programmers

EPROM Erasers	
Model 851	120
EPROM Programmers	
Models 844USB, 848A	117
Model 859	118
Model 866B	117, 119

Electrical Testers

AC Line Separator	
Model 301	104
Earth Resistance Meter	
Model 309	106
High Voltage Meter	
HV-44A	62
Insulation Testers	
Models 300, 305, 307A, 308A	105

Milli-Ohm Meter	
Model 310	107
Phase Rotation Meter	
Model 302	104
Power Clamp	
Model 325	70

Electronic Load

Electronic Load	
Model 8500	31
Model 8510	32

Environmental Testers

Air Velocity Meter	
Model 731A	135
Digital Carbon Monoxide Meter	
Model 627	134
Digital Infrared Thermometer	
Model 635	133
Model 636	132
Digital Light Meter	
Model 615	134
Digital Thermo-Hygrometer	
Model 625	133
Digital Thermometer	
Model 630	133
Dual Display Humidity & Temperature Meters	
Models 720, 725	131
Dual Input Dual Display Digital Thermometer	
Models 710, 715	132
PH Meter	
Models 760DX, 760DOP, 760PH, 760	130
Model 760KIT	129
Sound Level Calibrator	
Model CAL73	135
Sound Level Meter	
Models 732A, 735	135

Function Generator

Arbitrary Function Generators	
Models 4070A, 4071	38, 39
Models 4084AWG, 4086AWG	34, 35
DDS Generators	
Model 4040DDS	41
Models 4007DDS, 4013DDS	43
Model 4017B	42
Model 4045	40
Models 4084, 4085, 4086, 4087	36, 37
Function Generators	
Models 4010A, 4011A	45
Multi-Function Generator	
Model 4051	46, 47
Pulse Generator	
Model 4030	48
RF Generator	
Model 2005B	51

Signal Generator	
Model 3003	50
Model 3001	51
Sweep Function Generators	
Models 4001A, 4003A,	49
Models 4017A, 4040A	44
Model 4012A	45

Multimeters

Analog Multimeters	
Models 114B, 117B	71
Bench Multimeters	
Model 5492GPIB	67
Model 2831D	65
Models 5491A, 5492	66, 67
Clamp-On Multimeters	
Models 312B, 313A, 316, 325	70
Models 330B, 350B, 367A, 369B	68, 69
DMM Kits with Test Leads	
Model 391AKIT	72, 140
Models 2704BKIT, 388BKIT	72, 140
Model 2880BKIT	57, 72, 140
Model 2890AKIT	57, 72, 140
Dual Display RS-232 Interface	
Models 2880B, 2890A	56, 57
Mini Pro® Multimeters	
Models 2407A, 2408, 2405A	62, 63
Pocket Multimeter	
Model 2700	65
Survivor® Multimeters	
Model 2860A	55
Test Bench® High Performance DMM	
Models 388B, 389A, 390A, 391A	58, 59
Tool Kit® Multimeters	
Models 2706A, 2707A, 2703B, 2704B	60, 61
Non-Contact ACV Detectors with Flashlights	
SENSELITE	64

Oscilloscopes

Analog Oscilloscopes	
Model 1541D	83
Model 2121	86
Model 2120B	85
Model 2125A	84
Model 2160A	82
Model 2190B	81
Digital Storage Oscilloscope	
Model 2530	77, 78, 79
Digital/Analog Oscilloscopes	
Model 2522B	80

Power Supplies

AC Power Supplies	
Models 1653A, 1655A	30
Models 1513, 1514	29

Educational Power Supplies	
Models 1501, 1502, 1503, 1504, 1505, 1510, 1511, 1520	28
Isolation Transformers	
Models 1604A, TR 110	29
Programmable DC Power Supplies	
Models 1696, 1697, 1698	19
Models 1770, 1785B, 1786B, 1787B, 1788	24
Models 9120A, 9121A, 9124	12, 13
Models VSP2050, VSP4030, VSP 6020, VSP12010	22, 23
Models VSP2050GPIB, VSP4030GPIB, VSP6020GPIB, VSP12010 GPIB	22, 23
Single Output DC Power Supplies	
Models 1620A, 1621A, 1623A, 1626A, 1627A	18
Models 1665, 1666, 1667	19
Models 1680, 1682A, 1692	27
Models 1686A, 1688A, 1689, 1690	25
Models 1735A, 1715A, 1730A, 1710A, 1711A,	16
Models 1740B, 1744A, 1743B, 1745A, 1746B	17
Models 1790, 1791, 1794, 1795, 1796	26
Triple Output DC Power Supplies	
Models 1670A, 1671A, 1672	21
Model 9130	14
Models 1652, 1651A, 1760A, 1761	20

RF Test Instruments

Highspeed Programmable Attenuators	
Models 6010, 6011, 6012, 6013	98

Spectrum Analyzers

Spectrum Analyzers	
Model 2630	94
Model 2650, 2652, 2658	89, 91

Telephone Testers

Telephone Testers	
Model 1045B	127

Video Testers

HDTV Pattern Generator	
Model 1253	123
NTSC Generators	
Models 1211E, 1249B	121
Video Monitor Testers	
Models 1275, 1280A	122

New Product Highlights

Generate Your Own Perfect Waveform

B+K Precision® offers the broadest range of function generators and signal sources in the industry.

- Growing line of arbitrary waveform generators that let you create complex waveforms for demanding applications in electronic test, design and sensor simulation

- Wide range of DDS generators for testing frequencies from DC to 120 MHz

- Large selection of low cost analog function generators for education, maintenance and service

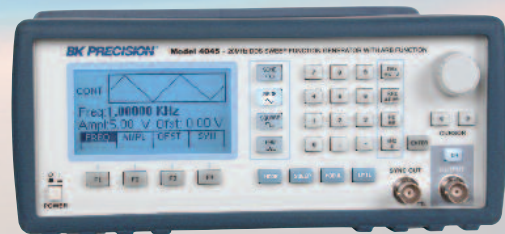

Products
Easy to Find
Easy to Use



**Universal
 Multiprogrammer
 Model 859**



**Highspeed Programmable
 Attenuators
 Models 6010, 6011,
 6012 & 6013**

Alpha Numerical Index

Model #	Page	Model #	Page	Model #	Page	Model #	Page
114B	.71	760	.130	1665	.19	2522B	.80
117B	.71	760ATC	.130	1666	.19	2530	.77, 78, 79
205	.124	760CP	.130	1667	.19	2630	.94
206	.124	760DOP	.130	1670A	.21	2650	.89, 93
230A	.125	760DX	.130	1671A	.21	2652	.89, 93
231A	.125	760KIT	.129	1672	.21	2658	.89, 93
261	.126	760PH	.130	1680	.27	2700	.64
262	.126	810C	.112	1682A	.27	2703B	.60, 61
300	.105	815	.111	1686A	.25	2704B	.60, 61
301	.104	830B	.112	1688A	.25	2704BKIT	.72, 140
302	.104	844USB	.117	1689	.25	2706A	.60, 61
305	.105	848A	.117	1690	.25	2707A	.60, 61
307A	.105	851	.120	1692	.27	2831D	.65
308A	.105	859	.118	1696	.19	2860A	.55
309	.106	866B	.117, 119	1697	.19	2880B	.56, 57
310	.107	875B	.111	1698	.19	2880BKIT	.57, 72, 140
312B	.70	878A	.111	1710A	.16	2890AKIT	.57, 72, 140
313A	.70	879	.111	1711A	.16	2890A	.56, 57
316	.70	881	.113	1715A	.16	3001	.51
325	.70	885	.109	1730A	.16	3003	.50
330B	.68, 69	886	.109	1735A	.16	4001A	.49
350B	.68, 69	889A	.110	1740B	.17	4003A	.49
367A	.68, 69	890B	.112	1743B	.17	4007DDS	.43
369B	.68, 69	1045B	.127	1744A	.17	4010A	.45
388B	.58, 59	1211E	.121	1745A	.17	4011A	.45
388BKIT	.72	1249B	.121	1746B	.17	4012A	.45
388BKIT	.140	1253	.123	1760A	.20	4013DDS	.43
389A	.58, 59	1275	.122	1761	.20	4017A	.44
390A	.58, 59	1280A	.122	1770	.24	4017B	.42
391A	.58, 59	1501	.28	1785B	.24	4040A	.44
391AKIT	.72	1502	.28	1786B	.24	4040DDS	.41
391AKIT	.140	1503	.28	1787B	.24	4070A	.38, 39
510A	.115	1504	.28	1788	.24	4030	.48
520C	.115	1505	.28	1790	.26	4040DDS	.41
570A	.114	1506	.28	1791	.26	4045	.40
575A	.114	1510	.28	1794	.26	4051	.46, 47
600	.108	1511	.28	1795	.26	4071	.38, 39
601	.108	1513	.29	1796	.26	4084	.36, 37
602	.108	1514	.29	1803D	.102, 103	4084AWG	.34, 35
615	.134	1520	.28	1804D	.102, 103	4085	.36, 37
625	.133	1541D	.83	1823A	.102, 103	4086	.36, 37
627	.134	1604A	.29	1856D	.102, 103	4086AWG	.34, 35
630	.133	1620A	.18	2005B	.51	4087	.36, 37
635	.133	1621A	.18	2120B	.85	5491A	.66, 67
636	.132	1623A	.18	2121	.86	5492	.66, 67
710	.132	1626A	.18	2125A	.84	5492GPIB	.67
715	.132	1627A	.18	2160A	.82	6010	.98, 101
720	.131	1651A	.20	2190B	.81	6011	.98, 101
725	.131	1652	.20	2405A	.62,63	6012	.98, 101
731A	.135	1653A	.30	2407A	.62,63	6013	.98, 101
732A	.135	1655A	.30	2408	.62, 63	8500	.31
735	.135						



**Handheld Spectrum Analyzer
with Tracking Generator
Model 2652**



**Single Output Programmable
DC Power Supply
Model 9120A**

Products & Services

Model #	Page	Model #	Page
8510	.32	N650	.137
9110	.15	PR 26M	.95
9120A	.12, 13	PR 100A	.88, 143
9121A	.12, 13	PR-150	.88, 143
9124	.12, 13	PR 2000	.88, 143
9130	.14	PR 28A	.73, 142
AK 2650	.95	PR 32A	.87, 145
AK 760	.130	PR 33A	.88, 143
AN 301	.95	PR 37AG	.88, 143
AN 302	.95	PR 37AR	.88, 143
AN 303	.95	PR 4000	.88, 143
AN 304	.95	PR-50	.144
AN 305	.95	PR-55	.88, 143
AN 306	.95	PR-60	.88, 143
BC 2650	.95	PT 2650	.95
BP 2650	.95	PX 2650	.95
CAL73	.135	SENSELITE	.64
CC 265	.95, 96	TL 1	.73, 142
CC 265	.148	TL 130A	.73, 142
CC 500	.150	TL 2A	.73, 142
CC 510	.145	TL 3	.73, 142
CC 520	.146	TL 30	.147
CC 540	.87	TL 4	.73, 142
CC 545	.147	TL-50	.73, 142
CC560	.97, 149	TL500	.141
CC 130	.87, 145	TL 5A	.147
CC-21	.87,145	TL 8	.73, 142
CC 540	.144	TL 889A	.110
CP 3	.73, 142	TLFG	.146
CT 2701	.95	TLPS	.147
DAS 600	.156	TP 1A	.134
DAS1400	.153-155	TP 29	.134
DP 21	.116	TP 2A	.134
DP 31A	.116	TP 3	.134
DP 52	.116	TPK-03	.134
FP 6	.115	TPK-04	.134
H100	.139	TPK-05	.134
H200	.138	TR110	.29
H240	.138	VSP12010	.22, 23
H300	.138	VSP2050	.22, 23
H400	.139	VSP4030	.22, 23
H500	.139	VSP6020	.22, 23
LC 2650	.95		
LC 760	.130		
LC 210A	.151		
LC 24	.151		
LC 28A	.151		
LC 29B	.151		
LC 33	.151		
LC 40	.151		
N625	.137		
N630	.137		

Service/Repair and Calibration Information

B+K Precision® supports products with repair or replacement for at least 5 years after they are discontinued. We stand by our impeccable quality.

If your unit should need repair, please go to our website at www.bkprecision.com to obtain an RMA number. Click on the "Service/Repair" button on our home page. You will find the flat rate repair cost as well as the shipping & handling charges.

Pack the unit well and ship to:

B+K Precision
Attn: Service Dept.
22820 Savi Ranch Parkway
Yorba Linda , CA 92887-4610

If the unit is under warranty, please provide a copy of the proof of purchase with the date of purchase clearly marked.

If the unit is out of warranty, prepayment (check, money order or credit card) is required before any work begins.

Include a brief description stating the problem and whether you want calibration with Certificate (N.I.S.T.), or Calibration with Data (N.I.S.T.). Have return shipping address clearly marked, and a phone number of a contact.

Standard turn around time is ten working days upon receipt of payment, and it does not include shipping time.

Package the unit carefully using the original box or filler and/or bubble wrap. Do not place two units in the same package. B+K Precision® is not responsible for damage to the unit due to shipping.

If there are any additional charges, other than the ones stated in the Service & Repair Cost List, the customer will be notified and informed of the charges. No service will be done to the unit until customer approves costs. If service is refused, customer is still responsible for return shipping.

Prices are subject to change without notice.

Specifications & Informations are subject to change without notice.

Power Supplies



Power Supply Use

A power supply is an electronic instrument that provides either Alternating (AC) or Direct (DC) Voltage/Current to an electronic circuit.

Applications

Power supplies find wide applications in:

- Education - used in technical schools to demonstrate electrical theory
- Design - used in circuit design to power up circuits
- Service - used to power up circuit boards under repair
- Maintenance - used to verify operation for set-up or repair equipment
- Manufacturing - used as part of the manufacturing process to verify operation parameters of designed equipment
- Quality Control - used for final testing of equipment

Series and Parallel Operation

There may be times when you require either more voltage or more current than your power supply provides. B+K Precision's single output power supplies can be hooked up in series to provide more voltage or in parallel to provide more current. On B+K Precision's triple output power supplies, two or three of the outputs can be connected in series or parallel by a mere press of a button.

Which Power Supply is Best for Your Application?

As with any test instrument purchase, you need to consider present and future requirements.

- What is the maximum voltage required?
- What is the maximum current required?
- Are multiple outputs needed?

Review the selection chart on the following page for a preliminary choice, then turn to the specific model number page for complete specifications.



Power Supplies

POWER SUPPLY TERMS

CONSTANT CURRENT SOURCE—A regulated power supply that delivers a constant current to a load, even when the load resistance changes.

CONSTANT VOLTAGE SOURCE—A regulated power supply that delivers a constant voltage to a load even when the load resistance changes.

CURRENT LIMITING—Ability to limit maximum current output at a preset value. This feature helps protect the load from overcurrent damage.

ISOLATION—Floating output, no reference to any voltage.

LINE REGULATION—How much the load voltage or current changes when the power supply is operated at varying line voltages throughout a given range. Typically stated as a percentage of the total voltage or current available from the supply. A rating of “0%” would mean perfect regulation.

LOAD REGULATION—How much the load voltage or current changes between operating the power supply at no-load and full-load conditions. Typically stated as a percentage of the total voltage or current available from the supply. A rating of “0%” would mean perfect regulation.

OVERLOAD PROTECTION—Means by which a power supply is protected from permanent damage due to short circuits, excessive loads, or reverse polarities connected across the load terminals. Protection may be as simple as a fuse (which can be economically replaced), or may be electronic protection circuitry which automatically monitors load conditions as well as power supply component temperatures.

POWER CONSUMPTION—The input power that is required by the power supply at a full load output condition.

POWER REQUIREMENTS—The line voltage that the power supply requires to operate. High quality power supplies have a selector switch that permits operation

from 110, 120, 220, and 240 VAC sources.

RECOVERY TIME—The time that it takes a power supply to regulate its output after an abrupt change, such as from full load to no load.

REGULATION—The ability to maintain a constant voltage or current at the load despite changes in line voltage or load resistance.

RIPPLE CURRENT—The portion of unfiltered AC current at the output of a filtered power supply.

RIPPLE VOLTAGE—The portion of unfiltered AC voltage and noise present at the output of a filtered power supply, operated at full load. Typically stated as rms and peak-to-peak AC voltage (with zero ripple voltage would represent a perfect power supply).

RMS VALUE (root mean square value)—The “effective” value of an AC or periodic voltage or current. The amount of work accomplished by a given rms value equals the amount of work accomplished by an equal DC value. The rms value can be obtained by first squaring the ordinates of the wave, then finding the average value of the squared wave, finally taking the square root of the average found. The rms value of a pure sine wave is 0.707 times the peak value ($RMS = V_p \times 0.707$), while the rms value of a square wave is 0.5 times the peak value $V_p = \text{Peak Value} = V_{pp}$.

TRACKING—Two power supplies (within one case) that are electrically coupled so that both can be varied by using only one knob.

TEMPERATURE COEFFICIENT—The change in power supply output voltage that is caused by temperature change. It is usually expressed in millivolts per degree. VA—Abbreviation for Volt-Ampere. Unit of input power delivered to a load. For electronic equipment, the “VA” load imposed on the isolation transformer or AC power supply is simply the load voltage multiplied by the load current, or the wattage rating of the load.

Power Supplies

Selection Guide

DC Power Supplies

TYPE	VOLTAGE	CURRENT	METERS	MODEL	PAGE	
Triple	0-24V (2) fixed 5V (1)	0-0.5A (2) 0-4A (1)	2 analog	1651A	20	
	0-24V (2) fixed 5V (1)	0-0.5A (2) 0-4A (1)	2 digital	1652		
	0-30V fixed 5V, 12V	0-3A 0-500mA (2)	2 digital	1670A		
	0-30V (2) fixed 5V, 12V	0-5A (2) 0-500mA (2)	2 digital	1671A		
	0-32V (2) fixed 5V (1)	0-3A (2) 0-3A (1)	2 digital	1672	21	
	0-30V (2) 4-6.5V (1)	0-2A (2) 0-5A (1)	2 digital	1760A		
	0-35V (2) 2-6.5V (1)	0-3A (2) 0-5A (1)	2 digital	1761	20	
	0-30V (2) 0-5V (1)	0-3A (2) 0-3A (1)	2 digital	9130		
	Single	0-18V	0-5A	2 analog	1620A	18
		0-18V	0-5A	2 digital	1621A	
		0-60V	0-1.5A	2 digital	1623A	
		0-30V	0-3A	2 analog	1626A	
		0-30V	0-3A	2 digital	1627A	
		0-30V	0-1A	2 analog	1710A	
0-60V		0-2A	2 analog	1711A	16	
0-60V		0-2A	2 digital	1715A		
0-30V		0-3A	2 analog	1730A		
0-30V		0-3A	2 digital	1735A		
0-60V		0-4A	2 analog	1740B		
0-35V		0-6A	2 digital	1743B		
0-35V		0-10A	2 analog	1744A	17	
0-35V		0-10A	2 digital	1745A		
0-16V		0-10A	2 analog	1746B		
0-30V		0-3A	2 digital	9120A		
Programmable	0-20V	0-5A	2 digital	9121A	12-13	
	0-72V	0-1.2A	2 digital	9124		
	0-17.5V (1) 0-35V (2)	0-6A (2) 0-3A (1)	2 digital	1770		
	0-18V	0-5A	2 digital	1785B	24	
	0-30V	0-3A	2 digital	1786B		
	0-60V	0-1.5A	2 digital	1787B		
	0-32V	0-6A	2 digital	1788		

Power Supplies

Selection Guide						
	TYPE	VOLTAGE	CURRENT	METERS	MODEL	PAGE
DC Power Supplies	Multi Range	0-60V	0-5A 100 W Max	LCD	9110	15
	Fixed	Fixed 13.8V	0-15A peak	None	1682A	27
		Fixed 13.8V	0-6A peak	None	1680	
	High Current	3-14V	0-12A @ 13.8V	2 analog	1686A	25
		3-14V	0-20A @ 13.8V	2 analog	1688A	
		1-15V	28A@≥ 13.8V	2 analog	1689	
		1-15V	28A@≥ 13.8V	2 analog	1690	
		0-32V	0-20A peak	2 digital	1790	26
		0-64V	0-10A peak	2 digital	1791	
		0-32V	0-30A peak	2 digital	1794	
		0-64V	0-15A peak	2 digital	1795	
	0-16V	0-50A peak	2 digital	1796		
	High Current & Switching	0-60V	0-20A	2 digital	VSP6020	22-23
		0-20V	0-50A	2 digital	VSP2050	
		0-40V	0-30A	2 digital	VSP4030	
		0-120V	0-10A	2 digital	VSP12010	
		0-60V	0-20A	2 digital	VSP6020GPIB	
		0-20V	0-50A	2 digital	VSP2050GPIB	
		0-40V	0-30A	2 digital	VSP4030GPIB	
0-120V		0-10A	2 digital	VSP12010GPIB		
Switching	3 - 15V	0-40A	2 digital	1692	27	
	1-20V	0-10A	2 digital	1665	19	
	1-40V	0-5A	2 digital	1666		
	1-60V	0-3.3A	2 digital	1667		
Programmable & Switching	1-20V	0-10A	LCD	1696	19	
	1-40V	0-5A	LCD	1697		
	1-60V	0-3.3A	LCD	1698		
AC	Low Current	120V	0-1.25A Continuous	None	1604A	29
		0-150V	0-2A Continuous	1 analog	1653A	30
		0-150V	0-3A Continuous	1 analog	1655A	
		90-140V 9 steps	0-2.5A Continuous	None	TR-110	29

For Educational & Laboratory Power Supplies Please See Page 28

DC Power Supplies

Single Output Programmable DC Power Supplies

Models 9120A, 9121A, 9124

B+K Precision® models 9120A, 9121A and 9124 are laboratory grade Programmable DC Power Supplies providing great performance and features not found in other supplies in this price category. The 9120 series are designed to meet the need of today's applications in R&D design verification, production testing or university labs that require clean and reliable power, high resolution and accuracy and fast transient response times.

- Excellent display resolution
- Low ripple and low noise
- Excellent temperature stability
- Fast transient response time (<20ms)
- SCPI compatible
- Front and Rear Output Terminals
- Closed case calibration
- Compact size for bench use or rack mountable (2U x 1/2U size)
- List mode operation for increased throughput. Download and execute command sequences from non-volatile memory



9120A

Front Panel Operation

The numeric keys and rotary knob provide a convenient interface for setting output levels quickly and precisely. Voltage and Current can be set to a maximum resolution of 0.5mV (2mV for 9124) and 0.1mA respectively. Up to 50 parameters can be stored and recalled from internal memory.

Selection Chart	models		
	9120A	9121A	9124
Output Voltage	0-32V	0-20V	0-72V
Output Current	0-3A	0-5A	0-1.2A

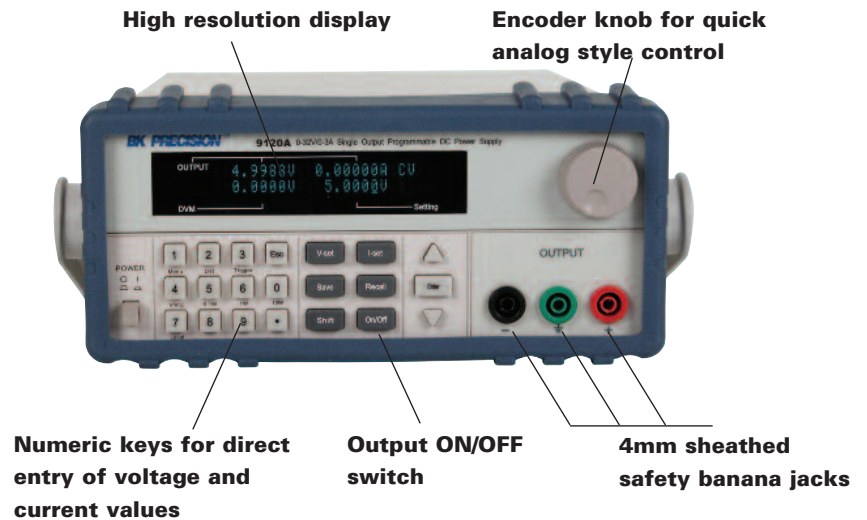

DC Power Supplies

Remote Interface

The power supplies can be remotely controlled from any PC with USB or RS232 interface, allowing you to program and monitor all parameters through easy to use SCPI commands. The power supplies come with a RS232 communication cable. A USB communication cable is available as option.

Extra Features

The 9120's digital port offers a variety of configurations. The port can operate in Digital I/O, external Trigger and DFI/RI (Discrete Fault Indicator/Remote Inhibit) mode. The RI feature can be used for turning several power supplies On/Off simultaneously. External triggering can be used in combination with List mode.

The included Application Software supports front panel emulation and allows users to generate simple test sequences without the need to write source code.

Additionally, the power supply comes with a built-in 5 1/2 digit DVM and high resolution milliohm meter supporting 4 wire measurements.

Temperature controlled cooling fan **DVM and mΩ meter** **User accessible fuse**

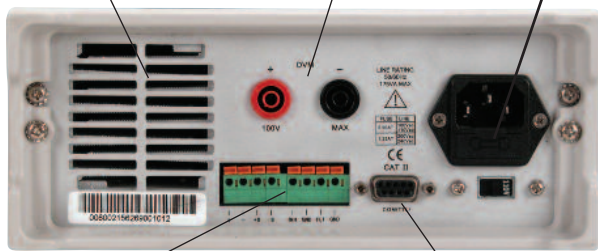

Remote Sense and digital port functionality

Serial Interface connector for RS232 or USB communication. (USB via optional communication cable)

Specifications

	models		
	9120A	9121A	9124
Output Ratings (0 °C~40 °C)	0 ~32V 0~3A	0 ~20V 0~5A	0~72V 0~1.2A
Load Regulation ±(%of output+offset)	<0.01%+2mV <0.05%+1mA		<0.01%+2mV <0.05%+0.3mA
Line Regulation ±(%of output+offset)	<0.01%+1mV <0.05%+0.1mA		<0.01%+1mV ≤ 0.05%+0.05mA
Programming resolution	0.1mV 0.1mA		0.1mV 0.05mA
Readback/ Meter resolution	0.1mV 0.01mA	0.1mV 0.05mA	0.5mV 0.01mA
Front panel setting resolution	0.5mV 0.1mA		2mV 0.1mA
Programming accuracy, 12months (25 °C ± 5 °C) ±(%of output+offset)	<0.03%+3mV <0.05%+2mA		≤ 0.03%+6mV ≤ 0.05%+1mA
Readback/ Meter accuracy 12months (25 °C ± 5 °C) ±(%of output+offset)	<0.02%+3mV <0.05%+2mA		≤ 0.02%+5mV ≤ 0.05%+1mA
Ripple & Noise (20Hz ~20MHz)	≤ 4mVp-p 3mA _{rms}	≤ 3mVp-p 3mA _{rms}	≤ 5mVp-p 3mA _{rms}
Temperature coefficient, (0 °C~40 °C) ±(% of output+offset)	<0.02%+3mV <0.05%+2mA		≤ 0.02%+5mV <0.05%+0.5mA
Readback temperature coefficient, ±(% of output+offset)	<0.02%+3mV <0.05%+2mA		≤ 0.02%+5mV ≤ 0.05%+0.5mA
DVM Accuracy	0~12V range: 0.02%+2mV 0~50V range: 0.02%+3mV		
DVM Resolution	0~12V range: 0.1mV 0~50V range: 1mV		
Milliohm Meter	Accuracy: 0.1% (for Voltage and Current >= 10% of FS) Accuracy: 0.3% (for Voltage and Current >= 3% of FS)		
State Storage Memory	50 user configurable memory locations		
Operating Temperature	0 to 40 °C, <75% R.H.		
Storage Temperature	-20 to 70 °C, <85% R.H.		
Power Requirements	115V/220VAC ± 10%, 47 to 63Hz		
Weight	19.8 lbs. (9 kg)		
Dimensions	8.45in(W) x 3.8in(H) x 13.9in(D) 214.5mm(W) x 88.2mm (H) x 354.6mm (D)		

Accessories

One Year Warranty

Supplied: User manual, line cord, RS232 communication cable, Software Installation disk
Optional: IT-E132 USB communication cable, IT-E151 rack mount kit, TL 5A (5A test leads), TL 30 (30A test leads), TLPS (Power supply test lead kit)



For a list of additional accessories, visit www.bkprecision.com

The 9120 Series uses 4mm sheathed banana jacks that accept sheathed or shrouded banana plugs and meet the latest international safety standards

DC Power Supplies



Triple Output Programmable DC Power Supply Model 9130

The 9130 is a fully programmable triple Output DC Power Supply delivering 0-30V/0-3A on 2 outputs and 0-5V/0-3A on 1 output. Each output is fully floating and outputs can be adjusted independently or connected in series or parallel to produce higher voltages or currents. The 9130 is ideally suited for applications in Electronic Test, Production and Service where multiple independent DC supplies are required and bench space is at a premium.

- **3 independent, fully programmable and electrically isolated outputs**
- **Display & adjust Voltage and Current settings for all 3 channels simultaneously**
- **Flexible output configuration: Connect any 2 or all 3 channels in parallel**
- **Excellent stability and regulation**
- **Very compact foot print (rack mountable 2U x 1/2U)**
- **SCPI compatible command set. Communicate via standard USB communication cable or optional RS232 cable**
- **OVP (Over Voltage) and OTP (Over Temperature) protection**
- **Output on/off control**
- **Application Software for front panel emulation and simple test sequence generation included**
- **50 memory locations for instrument state storage & recall**
- **Closed case calibration**

Specifications

	9130 model	
	Voltage	Current
Output Ratings	0 ~ 30V (Ch1 & Ch2) 0 ~ 5V (CH3)	0 ~ 3A (Ch1 & Ch2) 0 ~ 3A (CH3)
Load Regulation ±(% of output+offset)	≤ 0.01% + 3mV	≤ 0.01% + 3mA
Line Regulation ±(% of output+offset)	≤ 0.01% + 3mV	≤ 0.1% + 3mA
Programming Resolution	1mV	1mA
Readback Resolution	1mV	1mA
Programming Accuracy 12 month, (at 25°C ± 5°C) ±(% of output+offset)	≤ 0.03% + 10mV	≤ 0.1% + 5mA
Readback Accuracy 12 month, (at 25°C ± 5°C) ±(% of output+offset)	≤ 0.03% + 10mV	≤ 0.1% + 5mA
Temperature Coefficient (0°C ~ 40°C) ±(% of output+offset)	≤ 0.03%+10mV	≤ 0.1%+5mA
Readback Temperature Coefficient ±(% of output+offset)	≤ 0.03%+10mV	≤ 0.1%+5mA
Tracking Accuracy Series Operation		≤ 0.05%+10mA
Tracking Accuracy Parallel Operation	≤ 0.02%+5mV	≤ 0.1%+20mA
Ripple	≤ 1mVrms/3mVp-p	
Noise	≤ 3mVrms	

General

State Storage Memory	50 memory location
Timer	Resolution: 1s, Range: 1s~999999s
Weight	19.8 lbs. (9kg)
Dimensions (W x H x D)	3.45" x 3.8" x 13.9" 214.5mm x 88.2mm x 354.6mm

Accessories

One Year Warranty

SUPPLIED: User manual, line cord, USB communication cable, software installation disk
 OPTIONAL: RS232 interface cable IT-EI31, TL 5A (5A test leads), TL 30 (30A test leads), TLPS (Power supply test lead kit)

DC Power Supplies

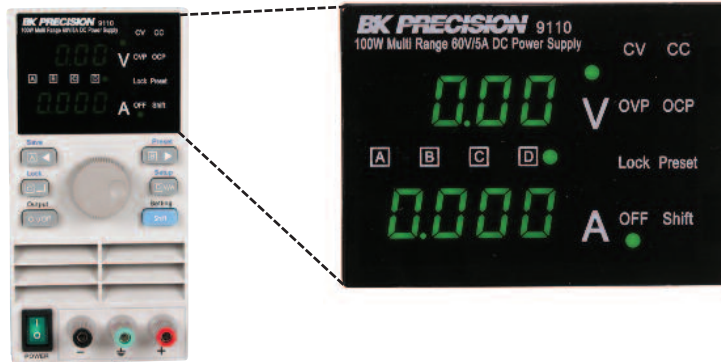

100W Multi Range 60V/5A DC Power Supply Model 9110

The 9110 is a new type of power supply. Unlike conventional power supplies with fixed output ratings, the 9110 automatically recalculates voltage/current limits for each setting, forming a constant power hyperbolic shaped boundary as illustrated in the diagram below. The 9110 provides 100W output power in any Volt/Amp combination within the rated voltage (60V) and current (5A) limits. By providing greatly expanded choices of Volt/Amp combinations, users can cut down on the number of power supplies required and free up valuable bench space.

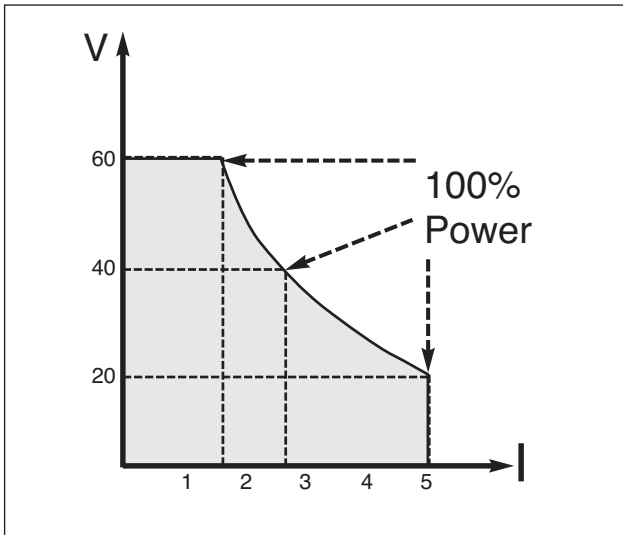

Example:
When setting the voltage to the maximum of 60V, the maximum current value is $100W/60V = 1.66A$. For a 20V setting, the maximum current is 5A. Full output power of 100W is possible for all Volt/Amp combinations that lie on the hyperbolic curve.

Key Features:

- Digitally controlled, mixed mode linear/switching DC power supply
- 10mV/1mA resolution over the full range
- Bright, easy to read display
- Very compact size and light weight
- Low ripple and noise
- High reliability due to OCP, OVP and OTP (Over current/voltage/temperature protection)
- Output On/Off control
- Store and recall 4 x 100 groups of preset Volt/Amp values
- Intelligent fan control

Specifications		model
	9110	
	Voltage	Current
Output Ratings	0 ~ 60V	0 ~ 5A
	Max. Power: 100W	
Load Regulation	$\leq 0.01\% + 3mV$	$\leq 0.01\% + 3mA$
Line Regulation	$\leq 0.01\% + 3mV$	$\leq 0.1\% + 2mA$
Setting Accuracy	$\leq 0.05\% + 10mV$	$\leq 0.2\% + 2mA$
Display Accuracy	$\leq 0.05\% + 10mV$	$\leq 0.1\% + 2mA$
Ripple	$\leq 2.0 mVrms$	$\leq 5 mArms$
General		
State Storage Memory	100 groups, with 4 sets of Volt/Amp memories each	
Weight	5.9lbs (2.65kg)	
Dimensions (W x H x D)	3.47" x 6.9" x 11.11" (88mm x 175mm x 282mm)	
Accessories		One Year Warranty
SUPPLIED: Line Cord, Manual		
OPTIONAL: TL 5A (5A test leads), TL 30 (30A test leads), TLPS (Power supply test lead kit)		

Single Output DC Power Supplies

Models 1710A, 1711A, 1715A, 1730A & 1735A

B&K 1730A Series are either dual analog or digital display, Single Output Digital DC Power Supplies. The digital display models are bench top units that provide the accuracy of dual 4-digit LED displays offering 10mV and 1mA of resolution. B&K power supplies offer exceptional control and accuracy with dual high-resolution, 4-digit LED or analog readouts at a very reasonable price and are ideal supplies for educational, service and maintenance, or manufacturing applications.



1730A



1735A

Specifications

	1710A	1711A	1715A	1730A	1735A
Output Voltage	0-30 V	0-60 V	0-60 V	0-30 V	0-30 V
Output Current	0-1A	0-2 A		0-3 A	
Constant Voltage Operation					
Voltage Regulation					
Line (120VAC ±10%)	≤0.01% + 3 mV				
Load (no load - full load)	≤0.01% + 3 mV				
Recovery Time	≤100 μs				
Ripple & Noise	≤1mV rms				
Temperature Coefficient	≤300 ppm/°C				
Constant Current Operation					
Adjustable Current Limit	5% to 100%				
Current Regulation					
Line (120VAC ±10%)	≤0.2% + 3mA				
Load	≤0.2% + 3mA				
Current Ripple	≤3mA rms				
Metering					
Type	2-Analog	2-Analog	Dual 4-digit LED	2-Analog	Dual 4-digit LED
Voltmeter Range	0-32V	0-64V	0-99.99V (green)	0-32V	0-99.99V (green)
Voltmeter Accuracy	±2.5%	±2.5%	± (0.5% rdg + 9 digits)	±2.5%	± (0.5% rdg + 9 digits)
Ammeter Range					
High Range	0-1.04 A	0-2.2 A	0-9.999 A (red)	0-3.2 A	0-9.999 A (red)
Low Range	0-0.26 A	0-0.55 A	--	0-0.53 A	--
Ammeter Accuracy	± 2.5%	± 2.5%	± (0.5% rdg + 9 digits)	±2.5%	± (0.5% rdg + 9 digits)
Overload Protection	Current limiting, reverse polarity, overvoltage, short circuit				
Power Requirements	120/220 VAC ±10%, 50/60 Hz				
Power Consumption	70W	210W	210W	180W	180W
Operating Temperature	32° to 104°F (0° to 40°C), ≤75% R.H.				
Storage Temperature	5° to 158°F (-15° to +70°C), ≤85% R.H.				
Dimensions (HxWxD)	6.2 x 5.5 x 12.5" (158 x 140 x 318 mm)				
Weight	8 lbs.(3.6 kg)	12 lbs.(5.4 kg)	12 lbs.(5.4 kg)	10.5 lbs.(4.7 kg)	10.5 lbs.(4.7 kg)

Accessories

Two Year Warranty

SUPPLIED: Line Cord, Manual
OPTIONAL: TL 5A (5A test leads), TL 30 (30A test leads), TLPS (Power supply test lead kit)

- Largest selection of voltage and current ratings ever offered
- Connect two supplies in parallel to double the current output
- Connect two supplies in series to double the voltage output
- Reliable, Durable
- Operate continuously at full load without overheating
- Fully overload protected
- Coarse and fine voltage controls
- Excellent regulation
- Very low ripple
- Constant voltage or constant current operation
- Continuously monitor voltage and current output on two meters
-  cUL Approved for models 1710A, 1711A, 1715A, 1730A, 1735A

Optional Accessory



5A Banana Plug Power Supply Cables

TL-5A

- 4mm Banana plug to alligator clip
- 5A rating
- Black and Red pair
- 40" (1.0m) length



1744A



1745A

Single Output DC Power Supplies

Models 1740B, 1743B, 1746B, 1744A & 1745A

B+K Precision® Series1740 are 0 to 60V, 0 to 10A DC Power Supplies. These power supplies have all of the great features you would expect B+K Precision power supplies to have and some new features not normally seen on power supplies in this price range, these features include an output On/Off button and a output-shorting button. The output-shorting button allows the user to short the output terminals to set the current limit.

- Largest selection of voltage and current ratings ever offered
- Connect two supplies in parallel to double the current output
- Connect two supplies in series to double the voltage output
- Reliable, Durable
- Operate continuously at full load without overheating
- Fully overload protected
- Coarse and fine voltage controls
- Excellent regulation
- Very low ripple
- Constant voltage or constant current operation
- Continuously monitor voltage and current output on two meters

Specifications

	1740B	1743B	1746B	1744A	models 1745A
Output Voltage	0-60 V	0-35 V	0-16 V	0-35V	0-35V
Output Current	0-4 A	0-6 A	0-10A	0-10A	0-10A
Constant Voltage Operation					
Voltage Regulation					
Line (120VAC ±10%)	≤0.2% + 2mV				
Load (no load - full load)	≤0.04% + 2mV				
Recovery Time	≤100 μs				
Ripple & Noise	1mV rms (Typical)				
Temperature Coefficient	≤300 ppm/°C				
Constant Current Operation					
Adjustable Current Limit	5% to 100%				
Current Regulation					
Line (120VAC ±10%)	≤0.4% + 5mA				
Load	≤0.4% + 5mA				
Current Ripple	≤3mArms				
Metering					
Type	2-Analog	Dual 4-digit LED	2-Analog	2-Analog	Dual 4-digit LED
Voltmeter Range	0-64V	0-99.99V (green)	0-16V	0-40V	0-99.99V
Voltmeter Accuracy	±2.5%	± (0.5% rdg + 9 digits)	±2.5%	+2.5%	±(0.7% + 9 digits)
Ammeter Range					
High Range	0-4.4 A	0-9.999 A (red)	0-11 A	0-11 A	0-9.999
Low Range	0-1.1 A	--	0-2.2 A	0-2.2 A	--
Ammeter Accuracy	± 2.5%	± (0.5% rdg + 9 digits)	± 2.5%	± 2.5%	±0.7% + 9 digits
Overload Protection	Current limiting, reverse polarity, overvoltage, short circuit				
Power Requirements	120/220 VAC ±10%, 50/60 Hz				
Power Consumption	450W	420W	380W	560W	560W
Operating Temperature	32° to 104°F (0° to 40°C), ≤75% R.H.				
Storage Temperature	5° to 158°F (-15° to +70°C), ≤85% R.H.				
Dimensions (HxWxD)	5.7 x 10.5 x 15" (145 x 267 x 381 mm)				
Weight	23 lbs.(10.4 kg)	24 lbs.(10.8 kg)	20 lbs.(9 kg)	31 lbs.(14.1 kg)	

Optional Accessory



30A Power Supply Cable

TL-30

- #10 Spade Lug to Large Battery Clips
- 30A rating
- Black and Red pair
- 30" (0.75m) length

Accessories

Two Year Warranty

SUPPLIED: Line Cord, Manual

OPTIONAL: TL 5A (5A test leads), TL 30 (30A test leads), TLPS (Power supply test lead kit)

Single Output DC Power Supplies

Digital and Analog Power Supplies

**Models 1620A, 1621A,
1623A, 1626A & 1627A**



1626A



1627A

- Connect two supplies in parallel to double the current output
- Connect two supplies in series to double the voltage output
- New compact style
- Reliable, Durable
- Operate continuously at full load without overheating
- Fully overload protected
- Coarse and fine voltage controls
- Great regulation
- Low ripple
- Constant voltage or constant current operation
- Continuously monitor voltage and current output on two meters

Specifications

	1620A	1621A	1623A	1626A	1627A
Output Voltage	0-18V	0-18 V	0-60 V	0-30 V	0-30 V
Output Current	0-5A	0-5A	0-1.5 A	0-3 A	0-3 A
Constant Voltage Operation					
Voltage Regulation					
Line (120VAC ±10%, -6%)	≤0.02% + 3mV				
Load (no load - full load)	≤0.02% + 3mV				
Recovery Time	≤500ms				
Ripple & Noise	0.5mVrms (Typical)				
Temperature Coefficient	≤300ppm/°C				
Constant Current Operation					
Adjustable Current Limit	0-100%				
Current Regulation					
Line (120VAC ±10%)	≤0.02% + 3mA				
Load	≤0.02% + 3mA				
Current Ripple	≤3mA				
Metering					
Type	2-Analog	Dual 3-digit LED	Dual 3-digit LED	2-Analog	Dual 3-digit LED
Voltmeter Range	0-20V	0-18V	0-60V	0-32V	0-30V
Voltmeter Accuracy	±7% FS	±0.2% + 2 digits	±0.2% + 2 digits	±7% FS	±0.2% + 2 digits
Ammeter Range	0-5 A	0-9.99 A	0-9.99 A	0-3 A	0-9.99 A
Ammeter Accuracy	±7% FS	±0.2% + 2 digits	±0.2% = 2 digits	±7% FS	±0.2% + 2 digits
Overload Protection	Current, limiting, reverse polarity, overvoltage, short circuit				
Power Requirements	120/220VAC ±10%, 50/60Hz				
Power Consumption	210W	220W	220W	210W	220W
Operating Temperature	32° to 104°F (0° to 40°C), ≤75% R.H.				
Storage Temperature	5° to 158°F (-15° to +70°C), ≤85% R.H.				
Dimensions (HxWxD)	8.07 x 4.53 x 10.63" (205 x 115 x 270 mm)				
Weight	13.2 lbs. (6 kg)	16.3 lbs. (7.4 kg)	16.3 lbs. (7.4 kg)	13.2 lbs. (6 kg)	16.3 lbs. (7.4 kg)

Accessories

One Year Warranty

SUPPLIED: Line Cord, Manual

OPTIONAL: TL 5A (5A test leads), TL 30 (30A test leads), TLPS (Power supply test lead kit)

DC Switching Power Supplies



1667



1696

DC Switching Regulated Power Supplies

Models 1665, 1666 & 1667

B+K's family of switching power supplies provides maximum current output continuously with minimal thermal drift. They have been designed with course and fine output voltage and current limiting controls. Bright, front panel mounted 3-1/2 digit LED auto-range meters provide 0.000 Amp readings and 0.00 Volt readings in the low range operation and automatically to 00.00 readings in the high range of the scale

- Over voltage protection, short circuit protection
- Constant voltage operation
- Constant current operations
- Presetting current limiting value

Specifications		models		
	1665	1666	1667	
Output Voltage	1-19V	1-40V	1-60V	
Output Current	0-10A	0-5A	0-3.3A	
Ripple & Noise	20mV	20mV	20mV	
Load Regulation	0.5%+200mV	0.5%+200mV	0.5%+200mV	
Line Regulation	20mV	20mV	20mV	
Input Voltage	90-265VAC, 50/60Hz			
Meter Type	2 Digital 3 Digit LED			
Meter Accuracy	1%+2 counts			
Dimension (HxWxD)	4.5" x 8" x 10.8" (114 x 203 x 274 mm)			
Weight	6.6 lbs (3 kg)			

Accessories **One Year Warranty**

SUPPLIED: Instruction Manual, Line Cord
 OPTIONAL: TL 5A (5A test leads), TL 30 (30A test leads), TLPS (Power supply test lead kit)

DC Switching Programmable Power Supplies

Models 1696, 1697 & 1698

BK Precision's models 1696, 1697, and 1698 DC Switching Mode Programmable Power Supplies offer 200 watts of power. This series of laboratory grade, switching mode, programmable power supplies is ideal for repetitive test routines in R&D, Production, Product Evaluation, and various applications.

Information appearing on the large back-lit LCD makes the panel controls simple and easy to use in spite of it's sophisticated features. Because of the MCU (Micro-Controller Unit) and the related software, user re-calibration without opening the case is an added bonus. When used with a standard PC, the supplied user friendly software and built in RS-232 interface provides two way communication improving the functionality of these unit. Data logging with color graphic display in adjusting range Voltage, Amps, Watts, and time periods are all valuable tools in data analysis.

Specifications		models		
	1696	1697	1698	
Output Voltage	1-20V	1-40V	1-60V	
Output Current	0-10A	0-5A	0-3.3A	
Ripple & Noise	25mV	25mV	25mV	
Load Regulation	0.5%+200mV	0.5%+200mV	0.5%+200mV	
Line Regulation	50mV	50mV	50mV	
Input Voltage	90 - 265VAC, 50/60Hz			
Display Meter	4 digit - display LCD Ammeter, Voltmeter and Power meter			
Meter Accuracies	1.5% + 2 counts			
LCD Module Back light	48 x 6mm			
Cooling System	thermostatic control fan			
Protection Devices	Over Temperature, Tracking OVP, Over Current			
Approvals	CE			
Dimensions (HxWxD)	3.85"x 7.6" x 8.46" (98 x 193 x 215 mm)			
Weight	6.61 lbs. (3 kg)			

Accessories **One Year Warranty**

SUPPLIED: Instruction Manual, Software & Line Cord
 OPTIONAL: TL 5A (5A test leads), TL 30 (30A test leads), TLPS (Power supply test lead kit)

Triple Output DC Power Supplies



1761



1652

Triple Output DC Power Supplies

Model 1760A, 1761

- Two 0-30 VDC, 2 A (1760A) sections capable of independent, series or parallel operation
- Two 0-35 VDC, 3 A (1761) sections capable of independent, series or parallel operation
- One 4-6.5 VDC, 5 A section (1760A)
- One 2-6.5 VDC, 5 A section (1761)
- Switchable series/parallel operation — 30 V sections
- Adjustable current limit controls — 30 V sections
- Two 4 digit LED displays — one reads volts or amps of "B" supply — one reads volts or amps of "A" supply or on third output 4V-6.5V supply
- Unique variable tracking, B track A at 5% to 100%

Compact Triple Output DC Power Supplies

Model 1652, 1651A

- Two 0 to 24 VDC outputs (0.5A)
- One fixed 5V output (4A)
- Independent or tracking operation
- Adjustable current limiting
- Designed to operate continuously at rated output
- Short circuit protection, overvoltage protection, reverse polarity protection
- Connect outputs in series for higher voltage output or in parallel for higher current output (switch selectable)

Specifications

	1760A	1761	1652	models 1651A
Output Voltage	0-30V (A & B) 4-6.5 V (C)	0-35V (A & B) 2-6.5 V (C)	0-24 V (A&B) Fixed 5V output	
Output Current	0-2A (A & B) 5A (C)	0-3A (A & B) 5A (C)	0-500 mA (A&B) Fixed Supply < 4 A	
Constant Voltage Operation				
Voltage Regulation				
Line (120VAC ±10%)	≤ 0.01% + 3 mV (A&B) ≤ 10 mV (C)		≤ 0.01% + 3 mV (A&B) ≤ 5 mV for line Fixed supply	
Load	≤ 0.01% + 3 mV (A&B) ≤ 10 mV (C)		≤ 0.01% + 3 mV (A&B) ≤ 50 mV (Fixed)	
Recovery Time	100µs			
Ripple & Noise (5Hz to 1MHz)	≤ 1mVrms		≤ 1mVrms (≤ 5mVrms for fixed output)	
Temperature Coefficient	≤ 300 ppm°C			
Constant Current Operation				
Adjustable Current Limit	5% to 100% (A&B)			
Current Regulation				
Line (120VAC ±10%)	≤ 0.2% + 3mA		≤ 0.2% + 6 mA	
Load	≤ 0.2% + 3 mA		≤ 0.2% + 3mA	
Current Ripple	≤ 3 mA rms			
Metering				
Display	2 digital 4 digit LED		2 digital 3 digit LED	2 Analog
Voltmeter Range	0-99.99 V (A & B) 0-99.99 V (C)		0-99.9 V (A & B)	0 to 25 V
Voltmeter Accuracy	± (0.5% rdg + 9 digits)		± (0.5% rdg + 2 digits)	2.5% of full scale
Ammeter Range	0-9.999 A		0-9.99 A	0 to 600 mA
Ammeter Accuracy	± (0.5% rdg + 2 digits)		± (0.5% rdg + 2 digits)	2.5% of full scale
Overload Protection	Current limiting, Reverse polarity, overvoltage, Short circuit			
Power Requirements	108-132 VAC 60 Hz, 120/220/230/240/ VAC, ± 10%, 50/60 Hz version available			
Power Consumption	350 W		165 W	
Operating Temperature	0° to 40°C ≤ 85% R.H.			
Storage Temperature	-15° to 70°C ≤ 85% R.H.			
Dimensions (H x W x D)	5.7 x 10.5 x 15" (145 x 267 x 381 mm)		5.5 x 11.75 x 10.975" (140 x 298 x 264 mm)	
Weight	21 lbs (9.5 kg)		10.5 lbs (4.8 kg)	
Accessories	Two Year Warranty		One Year Warranty	
SUPPLIED	Instruction Manual, Spare Fuse Line Cord		Instruction Manual, Line Cord Test Leads TL-5(3 pairs), Spare Fuse	
OPTIONAL	TL 5A (5A test leads), TL 30 (30A test leads), TLPS (Power supply test lead kit)			

Triple Output DC Power Supplies

Triple Output DC Power Supplies

Models 1670A & 1671A

- One variable 0-30 VDC, 3 A(1670A) section, 5 A(1671A) section
- One 12 VDC fixed section
- One 5 VDC fixed section
- Ideal for general electronic servicing, school electronics labs, and powering up hobbyists projects



1670A



1672

Quad Display Triple Output DC Power Supply

Model 1672

The model 1672 is a quad display triple output regulated DC power supply that provides one fixed output (5V/3A) and two variable outputs (0-32V/ 0-3A) ratings. The variable outputs can work independently, or in series tracking or parallel mode.

Model 1672 offers exceptional performance and is an ideal supply for Educational, Service and Maintenance, Hobbyist and Manufacturing applications.

Model 1672 provides the user with many unique and useful features not normally found in a triple output power at this low price.

Model 1672 features four large, easy-to-read front-panel-mounted 3-digit LED displays – one set reading volts and amps of the "B" supply, the other set reads volts and amps of the "A" supply. The unit has a unique variable tracking, B track A at 5% to 100% capability.

- Independent control of Voltage and Current controls for variable output.
- CV/CC operation.
- Separate 3 digit displays for voltage (Green) and current (Red) for both variable outputs.
- LED indication for CV (Green)/ CC (Red) mode.
- Overload indication LED for Fixed output.
- Series tracking and parallel mode operation for Triple output unit.

Specifications		models		
	1670A	1671A	1672	
Output Voltage	Main 0-30 VDC		0-32 VDC	
	A - Fixed 12VDC ±5%		0-32 VDC	
	B - Fixed 5 VDC ±5%		Fixed 5VDC	
Output Current	0-3 A Main	0-5 A Main	0-3A	
	Fixed 0-500 mA continuous		0-3A	
	Fixed 0-500 mA continuous		Fixed 0-3A	
Constant Voltage Operation				
Voltage Regulation	Line (120VAC ±10%)		≤ 0.05% + 10mV Main	
			≤ 0.01% + 5mV	
Load	(0 to rated load) ≤ 0.05% + 10mV		≤ 1% (Fixed)	
			≤ 0.2% + 10mV	
Ripple & Noise	≤ 5mVrms		≤ 1mVrms	
Adjustable Current Limit	5% to 100% (Main)		5% to 100% (Main)	
Current Regulation				
Line (120VAC ±10%)	≤ 0.4% + 10mA		≤ 0.01% + 5mA	
	Load		≤ 0.4% + 10mA	
Current Ripple	≤ 0.4% + 10mA		≤ 0.2% + 8mA	
	≤ 10mA rms		≤ 1mA rms	
Metering				
Display	3 Digit LCD		4 Digital LED	
Voltmeter Accuracy	±(1% reading + 2 digit)		±(1% reading + 3 digit)	
Ammeter Accuracy	±(1% reading + 2 digit)		±(1% reading + 3 digit)	
Overload Protection	Current limiting, Reverse polarity, overvoltage, Short circuit			
Power Requirements	120/220/ VAC, ±10%, 50/60 Hz		115/230 VAC, 60 Hz	
Power Consumption	170 W			
Operating Temperature	0 to 40°C ≤ 75% R.H.		10° to 40°C ≤ 90%R.H.	
Storage Temperature	-15° to 70°C ≤ 85% R.H.			
Dimensions (H x W x D)	4.9" x 8.5" x 11.5"		9" x 6.7" x 12.2"	
	(124 x 216 x 292 mm)		(230x170x310 mm)	
Weight	10.5 lbs (4.5 kg)	14.3 lbs (6.5 kg)	12.6 lbs (5.7 kg)	
Accessories		One Year Warranty		
SUPPLIED: Instruction Manual, Line Cord				
OPTIONAL: TL 5A (5A test leads), TL 30 (30A test leads), TLPS (Power supply test lead kit)				

High Power Switching DC Power Supplies

**Models VSP2050 (20VDC/50A),
VSP4030 (40VDC/30A),
VSP6020 (60VDC/20A),
VSP12010 (120VDC/10A)**



Stackable & Rackable

High-power, low-noise Switching DC Power Supplies

The VSP Power Supplies utilizes modern switch mode technology to produce high-power, low-noise switching supplies that cost around 25 percent less than linear supplies with the same power which offers as much as 1.2 kilowatts in a 19-inch rack mountable chassis that measures just 1U (1.75 inches) in height.



The many outstanding features of the VSP DC Power Supplies are:

■ **Precise output voltage control via:**

1. **manual tuning utilizing front panel mounted ten-turn potentiometers and three-digit meters**
2. **Remote control from an RS-232 Interface or GPIB Interface (Add "GPIB" to model number)**
3. **Analog remote sensing automatically maintains desired voltage at load level of power cable.**

■ **Provides 1.2 kilowatts at 20V, 40V, 60V or 120V output voltages**

■ **Compact 1U (1.75 inch by 19 inch rack mountable chassis)**

■ **Up to nine units can be cascaded, producing more than 10 Kilowatts of DC power.**

■ **Front-to-back air flow allows full power operation even when stacked.**

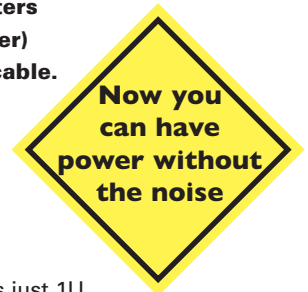

The new power supplies pack as much as 1.2 kilowatts into a 19-inch, rack-mountable box that measures just 1U (1.75 inches) in height. Furthermore, the VSP Power Supply achieves an energy conversion efficiency of 80%, while keeping noise levels under 20 millivolts.

Behind the performance advantages of the VSP series are advances in switching techniques. Two are particularly significant, soft switching, and two-device asynchronous half-bridge DC to DC converter design. The soft switching technique is a vital step for reducing switching noise. The technique ensures that the switching action will occur when the voltage across the switching device is at a minimum. By turning the switching device on and off in the converter when there is little voltage across it, the transformer load does not see sharp voltage transients. Eliminating that transient gets rid of much of the high-frequency system noise that would otherwise propagate through the transformer to the output stage. It also helps reduce the noise that typically feed back to the source. A built-in RFI filter further reduces power line noise, allowing the supplies to meet EN55022 Class A standards.

The VSP series further reduces noise by using a "piggy back" linear regulator to follow the conversion stage. The total effect is to improve the transient response to the changes in load and to reduce output noise and ripple from the DC converter. Along with controlling output noise, the converter and regulator allow the VSP series devices to offer precise output voltage control.

High Power Switching DC Power Supplies

Specifications		models			
		VSP6020*	VSP2050*	VSP4030*	VSP12010*
Output Specification					
Power	1.2KW	1.2KW	1.2KW	1.2KW	1.2KW
Output Voltage	0-60V	0-20V	0-40V	0-120V	0-120V
Output Current	0-20A	0-50A	0-30A	0-10A	0-10A
Ripple rms. (10Hz to 1MHz)	≤ 10mV	≤ 15mV	≤ 10mV	≤ 20mV	≤ 20mV
Noise (10Hz to 20MHz)	≤ 45mVpp	≤ 45mVpp	≤ 45mVpp	≤ 45mVpp	≤ 45mVpp
Programming Resolution(Digital Interface), LSB (not LED displays)					
Voltage	20 mV	10 mV	10 mV	100 mV	100 mV
Current	10 mA	20 mA	10 mA	10 mA	10 mA
Output Programming Accuracy(Analog Programming 0 To 5v & 0 To 10)					
Voltage	0.5 % of F. S. ± 1 Digit (spec. for all VSP models)				
Current	0.5 % of F. S. ± 1 Digit (spec. for all VSP models)				
Meter Accuracy					
Voltage	+/- 0.2% of FS. +/- 3 Digit. (spec. for all VSP models)				
Current	+/- 0.2% of FS. +/- 3 Digit. (spec. for all VSP models)				
Regulation					
CV Line Regulation	0.1 % of FS (spec. for all VSP models)				
CC Line Regulation	0.1 % of FS (spec. for all VSP models)				
CV Load Regulation	0.1 % of FS (spec. for all VSP models)				
CC Load Regulation	0.1 % of FS (spec. for all VSP models)				
Output Specification					
Stability	0.05%				
Efficiency	80% Minimum				
Transient Response	250 microseconds for load change from 40% to 90%				
Mode Of Operation					
Local Mode	Through front panel potentiometer for voltage, current and over voltage and Push switch for Output ON/ OFF control.				
Remote Mode	Interface Analog programming of voltage and current.				
Voltage	0 - 5 volts or 0 - 10 volts for output voltage and current, selection through DIP-switch.				
Resistance	0 - 4.85k ohms from 0 to full-scale level.				
Digital Interface	RS-232 / GPIB				
Protections					
Over voltage protection	Programmable through POT in local mode and through digital interface in remote mode.				
Over temperature protection	Through 90 °C. Thermal switch on heat sink.				
Input specifications					
Mains Input Range	95Vac to 264Vac.				
Input Frequency	47 To 63 Hz				
Input Power Factor	0.99 On Full Load At Nominal Input.				
Inrush Current	Limited By NTC				
Operating Environment					
Temperature	0 - 50°C				
Relative Humidity	< 80% rh - non condensing				
Storage Temperature	- 20°C. to + 70°C.				
Warm-up Time	15 minutes.				
Safety Standards					
EMI Filtering	EN55022 Class-A				
Safety Class	EN60950				
Mechanical Specifications					
Weight (approx.)	13.7lbs. (6.2 KG.)				
Dimensions (WxHxD)	19 x 1.75 x 18" (483 x 44.5 x 457mm)				
Dimensions with rubber feet	19 x 2.13 x 20" (483 x 54 x 457mm)				
Accessories		One Year Warranty			
SUPPLIED: Instruction Manual					
OPTIONAL (for all models): TL 5A (5A test leads), TL 30 (30A test leads), TLPS (Power supply test lead kit)					

* = Specification also apply to corresponding GPIB model (Add GPIB to the model number for a GPIB interface instead of a RS232 interface. Example: VSP6020GPIB)
 FS = Full Scale. Full scale will be different for each model. Example: If you have a VSP2050 and you are measuring the voltage meter accuracy, the meter can not off more than 0.3V (20V + 0.2% +3 digit). Note: 3 digits refers to the power supply displays least significant digit.

Programmable DC Power Supplies



1786B



1770

Programmable DC Power Supplies

Model 1785B, 1786B, 1787B & 1788

Models 1785B, 1786B, 1787B & 1788 are Programmable Power Supplies offering a new level of "ease-of-use" and programmability in a low-cost package. Direct key entry makes voltage and current selection fast, accurate and easy. User programmed outputs allow the operator to preset 99 frequently used voltage and current settings into memory for easy recall. Preprogram a 10 step output routine via the keypad or PC interface for automated testing in production or R&D. Closed case calibration allows for simple, cost-savings, uninterrupted operation.

- Sixteen user programmable preset outputs
- Controllable Output On/Off Switch
- 10mV/10mA display resolution
- Closed case calibration
- Low ripple and noise
- Excellent temperature stability
- Serial interface cable and software included

GPIB Programmable Power Supply

Model 1770

The model 1770 features excellent reliability (50K hrs. MTBF) and user flexibility. You can choose voltages to 35VDC, currents to 6A in single output model, and rest assured you'll find the quality you have come to expect from B+K.

- Excellent programming resolution and accuracy
- Integral system software makes in-case calibration quick and accurate
- Large character LCD display assures fast, "easy-to-read" measurements

B+K Precision power supplies can be used in a wide variety of applications such as: Electronics, Manufacturing, Design Labs, Electronic Education and Battery Charging.

Specifications

	models			
	1785B	1786B	1787B	1788
Output (DC)	0 - 18V	0 - 30V	0 - 60V	0-32V
Output Current (Amp.)	0 - 5A	0 - 3A	0 - 1.5A	0-6A
Metering Accuracy	+(0.5% + 2 digits)			
Ripple & Noise (RMS)	1mV			
Line Regulation	0.02% + 5mV			
Load Regulation	0.02% + 5mV			
RS-232	Option			
Operating Voltage	"120V, 60Hz (or on request 220 - 240V)"			
Dimension (WxHxD)	"8.07 x 4.53 x 10.63"' (205 x 115 x 270 mm)"			
Weight	11 lbs. (5Kg)			
Display	LED Voltmeter & Ammeter			

Accessories

Two Year Warranty

SUPPLIED: User Manual, Serial Cable, Windows® & DOS Software, Line Cord
 OPTIONAL: TL 5A (5A test leads), TL 30 (30A test leads), TLPS (Power supply test lead kit)

Specifications

	model
	1770
DC Output MAX Ratings	
Voltage	0-17.5V; 0-35V
Current	0-6A; 0-3A
Programming Resolution	
Voltage	10mV
Current	2mA
OVP	200mV
Programming Accuracy	
Voltage	0.05% +2 LSB
Current	0.15% +5 LSB
OVP	2.4% +0.3V
Line Regulation (120V ±10%)	0.001%
Load Regulation	0.001% + 1mV
Ripple & Noise	1mVrms
Operating Voltage	110 - 120VAC, 220 - 230VAC
Dimensions (W x H x D)	8.4 x 5.2 x 15.7 (213 x 132 x 398mm)
Weight	18lbs. (8.1kg)
Display	4 digit alphanumeric LCD

Accessories

Three Year Warranty

SUPPLIED: User Manual, Line Cord
 OPTIONAL: TL 5A (5A test leads), TL 30 (30A test leads), TLPS (Power supply test lead kit)

DC Power Supplies



1690



1688A

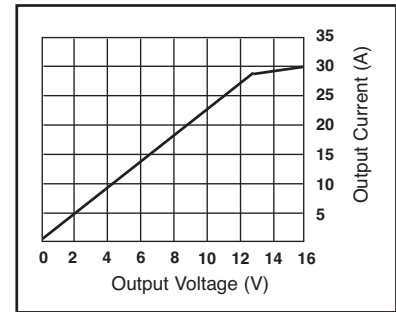

* Graph showing the relationship the output voltage has on the output current. (Models 1689 & 1690)

These B+K high current DC power supplies are designed for continuous duty and are ideal substitutes for car batteries in applications such as servicing/demonstrating high-power car stereos, cellular phones, camcorders, and ham radios. Hobbyists, retailers, and service shops use car batteries to power mobile equipment. Car batteries are heavy, can't tolerate shorted outputs, and must be recharged.

These Power Supplies provide their maximum current output without overheating. For higher output, just connect two or more in parallel or series. These are the only high-current supplies in their price range built to provide continuous duty.

Regulated 28A DC Power Supplies

Model 1689 & 1690

The new B+K Precision Regulated 28A DC Power Supplies 1689 & 1690 offer multiple DC output terminals; two pairs of 3A, snap-in DC connectors are easily accessible on the front panel, and a pair of 28A screw-on DC output terminals are located on the rear panel. Both models provide their maximum current output continuously hour after hour without thermal drifting. They are ideal car battery substitutions for servicing or demonstrating high power car stereo, cellular phone products, or even ham radio.

- 1VDC to 15VDC Variable Output
- 28A Output at ≥ 13.5 VDC
- Overload protection
- High RFI stability
- Multiple DC Output Terminals.

Variable Voltage - 3 to 14 volts DC

Models 1686A & 1688A

- 20 A guaranteed @ 13.8v (Model 1688A)
- 12 A guaranteed @ 13.8v (Model 1686A)
- Current limiting overload protection
- Over voltage protection
- Short circuit protection
- Reverse polarity protection
- Thermostatically controlled cooling fan
- Thermal protection
- Operates continuously at full load without overheating

Specifications	models	
	1689	1690
DC Output MAX Ratings		
Voltage	1-15V	
Current	*28A (@13.8V)	
Meter Accuracy	7% FS	$\pm(0.2\% + 2 \text{ digits})$
Line Regulation	5mV ($\pm 2\%$ Load)	
Load Regulation	50mV (0-100% Load)	
Ripple & Noise (RMS)	5mV	
Operating Voltage	120 VAC, 60 Hz	
Dimension (W x H x D)	9.84 x 5.5 x 8.86" (250 x 140 x 225mm)	
Weight	19.9 lbs. (9kg)	
Display	Precision Analog	Digital LED

Accessories One Year Warranty

SUPPLIED: User Manual, Line Cord
 OPTIONAL: TL-30

Specifications	models	
	1686A	1688A
Output		
Output Voltage	3 to 14 VDC	
Output Current	Proportional to Output Voltage	
DCV Output-Max DCA	3V -2.5A 5V - 4.5A 9V - 7.5A 12V - 10A 13.8V - 12A 14V - 12A	3V -4.5A 5V -7.5A 9V -13A 12V -20A 13.8V -20A 14V -20A
Line Regulation	(108-132VAC) $\leq 0.8\%$	
Ripple and Noise	$\leq 10\text{mVrms}$.	
Metering		
Voltmeter Range	0-20V	0-30V
Voltmeter Accuracy	$\pm 7\%$ FS	
Ammeter Range	0-20A	0-30A
Ammeter Accuracy	$\pm 7\%$ FS	
General		
Power Requirements	120/220 VAC $\pm 10\%$, 50/60 Hz.	
Power Consumption	400W	580W
Operating Temperature	32° to 104°F (0° to 40°C), $\leq 85\%$ R.H.	
Storage Temperature	5° to 158°F (-15° to 70°C), $\leq 75\%$ R.H.	
Dimensions (HxWxD)	4.9 x 8.5 x 11.5" (124 x 216 x 292mm)	
Weight	12.1 lbs. (5.5kg)	19.8lbs. (9kg)

Accessories One Year Warranty

SUPPLIED: Instruction Manual, Line Cord
 OPTIONAL: TL 5A (5A test leads), TL 30 (30A test leads), TLPS (Power supply test lead kit)

High Current DC Power Supplies



1791



1794

High Current DC Power Supplies

Models 1790, 1791, 1794 1795 & 1796

Models 1790's are cost effective, high power, regulated DC power supplies with high power. Suitable for bench operation or standard operation. These linear power supplies are high power workhorses that will easily deliver clean power to your high-current circuits.

Ideal for telecom application

Since noise elimination is critical for telecom application, the 1790 series DC power supplies offer low noise output, so that the power supply does not interfere with testing of telecom devices. These 1790's are ideal for manufacturers who build equipment for telecom industry that operates from 48V or higher DC rail such as base stations, switches, public and private telecom network

equipment, PBX system and DC to DC power supplies that provide power to this equipment.

These well-regulated constant voltage/constant current supplies can be adjusted continuously throughout the output range by front panel controls. The units will automatically cross over from constant voltage to constant current mode and vice-versa if the output exceeds preset limits. Front panel LED meters are provided for monitoring voltage and current. The load terminals and remote sense terminals are located on the front panel. Either the positive or negative output terminal may be grounded or floated up to a maximum of $\pm 300\text{VDC}$ above ground.

Special features include the ability to set constant current with no load and remote sense to compensate for any wire loss. These power supplies have superior performance to comparable models costing 20 to 30% more.

Specifications

	1790	1791	1794	1795	models 1796
Output Voltage (DC)	0-32V	0-64V	0-32V	0-64V	0-16V
Output Current (DC)	0-20A	0-10A	0-30A	0-15A	0-50A
Constant Voltage Mode					
Line Regulation (120V \pm 10%)	$\pm 0.01\% \pm 2\text{mV}$				
Load Regulation	$\pm 0.01\% \pm 2\text{mV}$				
Ripple and Noise	$\leq 1\text{mV rms max (20Hz - 20MHz)}$				
Constant Current Mode					
Line Regulation (120V \pm 10%)	$\pm 0.05\% \pm 10\text{mA}$				
Load Regulation	$\pm 0.05\% \pm 10\text{mA}$				
Ripple and Noise	$\leq 6\text{mA rms Max (20Hz - 20MHz)}$				
Overload Protection	Constant current type				
Stability	$\pm 0.2\% \pm 10\text{mV}$ in CV mode $\pm 0.5\% \pm 10\text{mA}$ in CC mode				
Operating Temperature	32° to 104°F (0° to 40°C)				
Power Requirement	120V, 60 Hz $\pm 10\%$ (230V, 50Hz Version Available)				
Dimension (W x H x D)	19 x 5.25 x 15.75" (483 x 133 x 400 mm)				
Weight	62 lbs. (28.1 kg)				

Accessories

Two Year Warranty

SUPPLIED: User Manual, Line Cord

OPTIONAL: TL 5A (5A test leads), TL 30 (30A test leads), TLPS (Power supply test lead kit)

- Constant Voltage/Constant Current Operation
- Remote Programming Facility
- Facility for Presetting the Output Voltage and Max. Load Current Limits
- Separate DC Output ON/OFF Switch
- Remote Sensing Facility
- High Stability and Close Regulation $\pm 0.01\%$

Switch Mode & Fixed DC Power Supplies



1680



1682A



Switch Mode Power Supply

Model 1692

The B+K 1692 Switching Mode DC Power Supply provides high current output in a lightweight and compact package. It is suitable for a variety of uses, especially for powering DC operated mobile radio equipment on the bench. It provides a variable voltage output from 3V to 15V at 40A continuous operation. In addition a fixed 13.8 VDC output is also selectable by a variable control knob. Switching mode power supplies have the advantage of light weight and high efficiency when compared to traditional linear mode power supplies. The efficiency can exceed 80% under the best conditions. Advanced circuitry protects against overload and provides immunity from RFI. A bright red and green LED display provides for an accurate and highly readable indicator of settings.

- **Lightweight and compact**
- **High efficiency**
- **Current fold-back circuitry with illuminated indicator prevents overloading the power supply**
- **Over temperature protection circuitry**
- **Over voltage protection prevents abnormal high output voltage**
- **High RFI stability**
- **Variable output 3V to 15V at 40A**

Fixed Voltage DC Power Supplies

Models 1680 & 1682A

- **13.8 volts DC output (fixed)**
- **Model 1680: 6 A peak**
- **Model 1682A: 15 A peak**
- **Current foldback overload protection**
- **Short circuit protection**
- **Reverse polarity protection**
- **Thermostatically controlled cooling fan (Model 1682A)**
- **Convenient cigar lighter output (Model 1680)**

Specifications

	models	
	1680	1682A
Output		
Output Voltage	Fixed 13.8 V \pm 0.5V	Fixed 13.8 V \pm 0.5V
Output Current	6 ADC peak, 4 ADC continuous	15 ADC peak, 12 ADC continuous
Line Regulation	(110-132VAC) \leq 130 mV	(110-132 VAC) \leq 0.8%
Ripple and Noise	\leq 10mV rms	
General		
Power Requirements	110-132 VAC, 60 Hz	
Power Consumption	185W	400W
Temperature Range		
Operating	0° to 40°C, \leq 75% R.H.	
Storage	-15° to 70°C, \leq 85% R.H.	
Dimensions(HxWxD)	3-5/8 x 6-5/16 x 6-3/4"	8.1" x 4.5" x 10.6"
	(92 x 160 x 170 mm)	(205 x 115 x 270 mm)
Weight	6.5 lbs. (2.9kg)	15 lbs. (6.75kg)

Accessories

One Year Warranty

SUPPLIED: Instruction Manual, Line Cord
 OPTIONAL: TL 5A (5A test leads), TL 30 (30A test leads), TLPS (Power supply test lead kit)

Specifications

	model
	1692
Output Voltage	3 - 15V or fixed 13.8VDC (selectable)
Output Current	40A continuous
Ripple and Noise	\leq 10mVrms
Line Regulation (120V \pm 10%)	80mV
Load Regulation	230mV (0 - 100% load)
Power Requirements	120 VAC, 60 Hz
Metering	Dual color digital LED
Dimensions (HxWxD)	8.67 x 4.33 x 11.82" (220 x 110 x 300 mm)
Weight	7.7 lbs. (3.5 kg)

Accessories **One Year Warranty**

SUPPLIED: Instruction Manual, Line Cord
 OPTIONAL: TL 5A (5A test leads), TL 30 (30A test leads), TLPS (Power supply test lead kit)

Educational / Laboratory Power Supplies

These power supplies provide AC and DC voltages for low current student work while saving precious bench space. These unit's steel case comes with projecting cover that protects the controls and connections and will withstand years of student abuse.



Model 1501
Dual Voltage 1.5V or 3V
High Current (3A) Battery



Model 1502
Heavy Duty Battery Eliminator



Model 1503
12 VAC/DC Power Supply



Model 1504
Compact 12V AC & DC Power
Supply (500mA) Heavy Duty
Battery Eliminator



Model 1505
Regulated DC Power Supply



Model 1506
Regulated AC/DC Power
Supply (12V AC/DC
2Amps x 2)



Model 1510
Discharge Tube Power Supply



Model 1511
Discharge Tube Power Supply



Model 1520
Universal Power Supply

Specifications

	1501	1502	1503	1504	1505	1506	1510	1511	1520
Output Voltage	3VDC	1.5VDC	0-12VDC	0-12VDC	0-20VDC	0-12VDC(2)	0-20VDC	0-50VDC	0-5 VDC
	1.5VDC	3VDC	12VAC	12VAC		0-12VAC(2)	0-500VDC	6.3VAC	8VDC
		4.5VDC				0-115VAC	AC1 1.0V	+8VDC	250VDC
		6VDC					AC2 2.1V	+250VDC	125VDC
		9VDC					AC3 3.2V	+125VDC	
		12VDC					AC4 4.2V		
							AC5 5.3V		
							AC6 6.3V		
Output Current	3A	0.5A	5A	0.4A	0.5A	2A	5A	3A	
							10mA	100mA	
							10mA	10mA	
							200mA	10mA	
Metering	N/A	N/A	2 Analog	N/A	N/A	Analog	2 Analog	2 Digital	N/A

Accessories

One Year Warranty

SUPPLIED: Instruction Manual, Line Cord

OPTIONAL: TL 5A (5A test leads), TL 30 (30A test leads), TLPS (Power supply test lead kit)

DC Power Supplies & Isolation Transformers

Switching Mode Power Supplies

Models 1513, 1514

The models 1513 & 1514 are DC Power Supplies that uses switching mode technology. They provides six ranges of selectable voltages for many applications.

- Plastic Housing
- Six ranges of selectable Voltages Output
- Overload and Short circuit protection
- Slim in size & light weight
- High Stability
- Fashionable design
- Wide range of operation Voltages

Specifications		models
	1513	1514
Output Voltage	3V	
	4.5V	
	6V	
	9V	
	12V	
Output Current	1 Amps	3 Amps
Ripple & Noise (rms)	25mV	
Line Regulation	60mV	
Load Regulation	300mV	
Operating Voltage	120VAC/60 Hz	
Dimensions (W x H x D)	90 x 50 x 140mm	

Accessories	One Year Warranty
SUPPLIED: Instruction Manual, Line Cord	
OPTIONAL: TL-5	



1513

Dual Output Isolation Transformer

Model TR-110

Use Model TR-110 for safe testing of transformerless equipment.

- **Direct: Convenience duplex outlet provides line voltage for auxiliary equipment up to 500 VA**
- **Isolated: Two 3-position slide switches provide 9 combinations of voltage selection from 90 to 140 V*, up to 350 VA continuous or 500 VA intermittent. Self-contained power switch with pilot lamp**

Specifications		model
	TR-110	
Input Requirements	105-130 VAC, 60 Hz.	
OUTPUT POWER RATING		
Direct	500 VA continuous. Isolated: 350 VA continuous, 500 VA intermittent.	
CONNECTIONS		
Direct	Duplex outlet (3-conductor).	
Isolated	Duplex outlet (3-conductor).	
GENERAL		
Regulation	No load (350 VA), voltage change < 4%.	
Isolation	Complies—UL standard 1012, May 1977.	
Dimensions (HxWxD)	5.1 x 5.5 x 8" (130 x 140 x 200 mm)	
Weight	11 lbs. (5 kg)	
*Output voltages rated w/input at 120 volts.		

Accessories	One Year Warranty
SUPPLIED: Instruction Manual, Line Cord	



TR-110

Isolation Transformer

Model 1604A

Use Model 1604A for safe testing of transformerless equipment.

- **Leakage: less than 0.1 mA**
- **Output Voltage: 117-124 V nominal (120 V input)**
- **Output Current: 1.25 A continuous**

Specifications		model
	1604A	
Isolation	leakage less than 0.1 mA	
Output Voltage	117-124 V nominal (120 V input)	
Output Current	1.25 A continuous (2A intermittent)	
Power Requirements	120 VAC, 60 Hz, 175W	
Operating Temperature	32° to 104°F (0° to +40°C)	
Dimensions (HxWxD)	4 x 4 x 5.5" (100 x 100 x 140 mm)	
Weight	6 lbs. (2.7 kg.)	

Accessories	One Year Warranty
SUPPLIED: Instruction Manual, Line Cord	



1604A

Variable Isolated AC Power Supplies



1653A

Model 1653A

Variable Isolated AC Power Supply. Model 1653A is a compact, rugged unit.

- Variable isolated 0-150 VAC
- 2A continuous output
- Displays voltage or current readings
- Isolation transformer to eliminate shock hazard while servicing "hot chassis" equipment



1655A

Model 1655A

Variable Isolated AC Power Supply. Model 1655A displays V, A, VA and leakage.

- Variable-isolated output—0-150VAC
- 3A continuous, 4A intermittent output
- Built-in soldering iron temperature control
- Expanded leakage scale
- Circuit breaker overload protection
- Displays V, A, VA, leakage

Specifications

	models	
	1653A	1655A
Voltage Adjustment Range	0-150 VAC with input at 120VAC	
Output Isolation	Leakage less than 0.1mA (25°C, 50% RH)	
Current Range	0 - 2A	0 - 3A
Maximum Current (Isolated)	2A continuous (0-130V)	3A continuous, 4A intermittent (0-130V)
Peak Current (inrush)	N/A	30A max. (inrush limited to one cycle at 30A)
Voltage/Current Sensing	Sine wave average, calibrated in RMS	
Meter Scale	0-150 VAC 0-2 VAC	0 - 150VAC 0- 240VA (voltage set at 120)
Leakage		0 - 5000 μ A (expanded in 100 - 500 μ A portion, compressed to 5mA full scale)
Metering	3 1/2" overrange protected	4 1/2" multicolor scales, overrange protected
Meter Accuracy	\pm 5% of full scale	\pm 5% of full scale (volts and current) \pm 5% at 500 μ A (leakage)
Soldering Iron Temp. Control		70 - 99% of power line (100W max.)
Power Requirements	120 VAC \pm 10%, 60 Hz 300VA at Maximum Output	120 VAC \pm 10%, 60 Hz 600VA at Maximum Output
Dimensions (HxWxD)	5.5 x 6.5 x 10.5" (140 x 165 x 267 mm)	10.5 x 5.7 x 12" (267 x 145 x 305 mm)
Weight	12 lbs. (5.5 kg)	22 lbs. (10 kg)

Accessories

One Year Warranty

SUPPLIED: Instruction Manual, Line Cord

Soldering Iron Temperature Control (Model 1655A only)

The Need for Temperature Control

Most servicing work requires the use of a soldering iron. If the soldering iron is plugged in only when it is needed, time is wasted waiting for the iron to heat up. But if it is left plugged in all the time, oxidation quickly erodes the tip. Also, soldering iron temperature varies with line voltage. Some irons reach the ideal temperature at 105 to 110 volts. As a result, at 120 volts, some soldering irons are too hot, which can more easily damage components being replaced or cause separation of circuit board plating.

Electronic Load



300W Programmable DC Electronic Load Model 8500

The model 8500 is an affordable full-featured Programmable Electronic DC Load with high accuracy and display resolution. They are great units for DC Power Supply and DC-DC Converter testing and calibration. Because this is fully programmable via the RS 232 or optional USB interface, it is ideal for Automated Test Systems.

- Operates Between 0-120VDC, 1mA-30A (300W MAX)
- High Resolution 0.1mA/1mV (range dependent)
- VFD Display
- CV/CC/CW/CR Operation
- Over-Current/Over-Voltage/Over-Power/Over-Temperature Protected
- RS 232 Interface Cable and Software Included
- Optional USB Interface Available (order IT-E132)
- Thermostat Controlled Internal Fan

The Model 8500 Programmable DC Electronic Load includes the necessary control and firmware capabilities to make it a complete and self-contained solution for automated functional testing of power devices. Through the front panel, test programs can be generated and then repeatedly executed with a single keystroke. Test results can be sent to the front panel, printer or a PC. The Model 8500 can be used as a stand-alone, bench top load or as a PC controlled subsystem within a larger automatic test station.

Specifications

	8500		
	Voltage	Current	Power
Input rating(0 ~ 40°C)	0 to 120V	1mA to 30A	300W
	Range	Accuracy	Resolution
Load Regulation	0-18V 0-120V 0-3A 0-30A	$\pm(0.05\%+0.02\%FS)$ $\pm(0.05\%+0.025\%FS)$ $\pm(0.1\%+0.1\%FS)$ $\pm(0.2\%+0.15\%FS)$	1mV 10mV 0.1mA 1mA
CV Mode Regulation	1.5-18V 1.5-120V	$\pm(0.05\%+0.02\%FS)$ $\pm(0.05\%+0.025\%FS)$	1mV 10mV
CC Mode Regulation	0-3A 0-30A	$\pm(0.1\%+0.1\%FS)$ $\pm(0.2\%+0.15\%FS)$	0.1mA 1mA
CR Mode Regulation	0.1-10 Ω 10-99 Ω 100-999 Ω 1K-4K Ω	$\pm(1\%+0.3\%FS)$ $\pm(1\%+0.3\%FS)$ $\pm(1\%+0.3\%FS)$ $\pm(1\%+0.8\%FS)$	0.001 Ω 0.01 Ω 0.1 Ω 1 Ω
CW Mode Regulation	0-100W 100-300W	$\pm(1\%+0.1\%FS)$ $\pm(1\%+0.1\%FS)$	1mW 10mW
Current Measurement	0-3A 0-30A	$\pm(0.1\%+0.1\%FS)$ $\pm(0.2\%+0.15\%FS)$	0.1mA 1mA
Voltage Measurement	1.5-18V 1.5-120V	$\pm(0.02\%+0.02\%FS)$ $\pm(0.02\%+0.025\%FS)$	1mV 10mV
Power Measurement	0-100W 100-300W	$\pm(1\%+0.1\%FS)$ $\pm(1\%+0.1\%FS)$	1mW 10mW
General			
Battery testing function			
Input	0.8-120V/500V		
Max measurement capacity	999A/H		
Resolution	10mA		
Timer range	1~60000sec		
Transition Mode			
Range of Frequency	0.1Hz-1kHz		
Frequency error rate	<0.5%		
Weight	11.6lb. (5.25kg)		

Accessories

One Year Warranty

SUPPLIED: Instruction manual, software & communication cable IT-E131
 OPTIONAL: USB interface kit IT-E132, rack mount IT-E151

Optional Accessory



USB Interface Kit Model IT-E132

Electronic Load

600W Programmable DC Electronic Load

Model 8510



The model 8510 is a cost effective Programmable DC Electronic Load with a high degree of accuracy, great display resolution and a wide operating range of up to 120A or 120V, 600W max. The 8510 is well suited for testing and calibrating DC Power supplies, DC-DC Converters and batteries. Programmability via the RS 232 or optional USB interface makes the units ideal for the use in Automated Test Systems.

- Operates between 0-120VDC, 1mA-120A (600W max)
- High resolution 1mA/1mV (range dependent)
- Bright easy to read display (VFD technology)
- CV/CC/CW/CR operation
- Over-Current/Over-Voltage/Over-Power/OverTemperature Protected
- RS 232 Interface cable and software included
- Optional USB interface cable available (order IT-E132)
- Thermostat controlled internal fan
- Battery test capability
- Generate complex test sequences without the need of an external PC

Programmability via the RS 232 or optional USB interface makes the Model 8510 suitable for use in automated test systems. The 8510 is a ready-to-run test solution that allows the test engineer to immediately start testing.

Optional Accessory



Rack Mount
Model IT-E151

The unit showing is not included

Specifications

	8510 model		
	Voltage	Current	Power
Input rating(0 ~ 40°C)	0 to 120V	1mA to 120A	600W
	Range	Accuracy	Resolution
Load Regulation	0-18V 0-120V 0-12A 0-120A	±(0.05%+0.02%FS) ±(0.05%+0.025%FS) ±(0.1%+0.1%FS) ±(0.2%+0.15%FS)	1mV 10mV 1mA 10mA
CV Mode Regulation	0.1-18V 0.1-120V	±(0.05%+0.02%FS) ±(0.05%+0.025%FS)	1mV 10mV
CC Mode Regulation	0-12A 0-120A	±(0.1%+0.1%FS) ±(0.2%+0.15%FS)	0.1mA 1mA
CR Mode Regulation	0.1-10Ω	±(1%+0.3%FS)	0.001Ω
Input Current ≥ FS 10%	10-999Ω	±(1%+0.3%FS)	0.01Ω
Input Voltage ≥ FS 10%	100-999Ω 1K-4KΩ	±(1%+0.3%FS) ±(1%+0.8%FS)	0.1Ω 1Ω
CW Mode Regulation	0-100W 100-600W	±(1%+0.1%FS) ±(1%+0.1%FS)	1mW 100mW
Current Measurement	0-12A 0-120A	±(0.1%+0.1%FS) ±(0.2%+0.15%FS)	1mA 10mA
Voltage Measurement	0-18V 0-120V	±(0.02%+0.02%FS) ±(0.02%+0.025%FS)	1mV 10mV
Power Measurement	0-100W 100-600W	±(1%+0.1%FS) ±(1%+0.1%FS)	1mW 100mW
Input Current ≥ FS 10%			
Input Voltage ≥ FS 10%			
General			
Battery testing function			
Input		0.8-120V	
Max measurement capacity		999A/H	
Resolution		10mA	
Timer range		1~60000sec	
Transition Mode			
Range of Frequency		0.1Hz-1kHz	
Frequency error rate		<0.5%	
Weight		30.8lb. (14kg)	

Accessories

One Year Warranty

SUPPLIED: Instruction manual, software & communication cable IT-E131
OPTIONAL: USB interface kit IT-E132, rack mount IT-E151



Function & Arbitrary Waveform Generators

Selection Guide for Function Generators and other Signal Sources

Direct Digital Synthesis (DDS)

ANALOG

TYPE	FREQUENCY	MODEL	WAVEFORMS							MODULATION		SWEEP	Burst	OUTPUT RANGE Into 50Ω	INTERFACE	PAGE
			Sine	Square	Triangle	TTL/CMOS	Ramp/Pulse	Arbitrary	Other	AM / FM	Other					
Arbitrary/ Function	1μHz - 80MHz	4086AWG	√	√	√	√	√	√	noise, complex	int/ext	FSK, PSK	√	√	1mV - 10Vpp	RS232	34-35
	1μHz - 20MHz	4084AWG	√	√	√	√	√	√	noise, complex	int/ext	FSK, PSK	√	√	1mV - 10Vpp	RS232	
	DC - 31.5MHz	4071	√	√	√	√	√	√	DTMF, SSB	int/ext	FSK, PM, BPSK	√	√	4mV - 10Vpp	RS232	38-39
	DC - 21.5MHz	4070A	√	√	√	√	√	√	Dual Tone, noise	int/ext	FSK, PM, BPSK	√	√	4mV - 10Vpp	RS232	
	0.1Hz - 20MHz	4045	√	√	√	√	√	√	noise	int/ext		√	√	1mV - 10Vpp	RS232	40
Function	1μHz - 120MHz	4087	√	√	√	√	√		noise, complex	int/ext	FSK, PSK	√	√	1mV - 10Vpp	RS232	36-37
	1μHz - 80MHz	4086	√	√	√	√	√		noise, complex	int/ext	FSK, PSK	√	√	1mV - 10Vpp	RS232	
	1μHz - 40MHz	4085	√	√	√	√	√		noise, complex	int/ext	FSK, PSK	√	√	1mV - 10Vpp	RS232	
	1μHz - 20MHz	4084	√	√	√	√	√		noise, complex	int/ext	FSK, PSK	√	√	1mV - 10Vpp	RS232	
	0.1Hz - 20MHz	4040DDS	√	√	√	√	√			int/ext		√		1mV - 10Vpp		41
	0.1Hz - 12MHz	4013DDS	√	√	√	√	√					√		50mV - 10Vpp		43
	0.1Hz - 7mHz	4007DDS	√	√	√	√	√					√		50mV - 10Vpp		
	0.01Hz - 10MHz	4017B	√	√	√	√	√					√		1mV - 10Vpp	RS232	42
Multi-function	0.15Hz - 20MHz	4051	√	√	√	√	√			int/ext		√	√	100mV - 10Vpp	RS232	46-47
Function	0.2Hz - 20MHz	4040A	√	√	√	√	√			int/ext		√		100mV - 10Vpp		44
	0.1Hz - 10MHz	4017A	√	√	√	√	√					√		100mV - 10Vpp		
	0.5Hz - 5MHz	4012A	√	√	√	√	√					√		100mV - 10Vpp		45
	0.5Hz - 5MHz	4011A	√	√	√	√	√							100mV - 10Vpp		
	0.5Hz - 4MHz	4003A	√	√	√	√	√					√		100mV - 10Vpp		49
	0.5Hz - 4MHz	4001A	√	√	√	√	√					√		100mV - 10Vpp		
	0.2Hz - 2MHz	4010A	√	√	√	√	√							100mV - 10Vpp		45
Signal	100kHz - 150 MHz	2005B	√							int/ext*				100mVrms max		51
	0.1Hz - 10 MHz	3003	√	√										100mV - 2.25Vpp		50
Pulse	0.1Hz - 10 MHz	4030		√										100mV - 5Vpp		48
Audio	20Hz - 150kHz	3001	√	√										100mV - 2.5Vpp		51

* AM modulation only

Function Generators

Arbitrary/ Function Generators

Models 4084AWG & 4086AWG

The B+K Precision® 4084AWG and 4086AWG are high performance laboratory grade synthesized function generators with arbitrary capability. Direct Digital Synthesis (DDS) techniques are used to create stable, accurate output signals for all 27 built-in standard and complex (arbitrary) waveforms. The generators produce high purity, low distortion sine waves up to 80 MHz, square waves up to 40 MHz and a stable output of very small signals down to the 1mV - 10mV range. The instrument also provides a built-in 100 MHz Universal Counter with frequency measurement and totalize function.

Unmatched affordability and excellent performance make models 4084AWG & 4086AWG a perfect fit for many applications in Electronic Test and Design, Sensor Simulation and Education and Training.

Custom waveform generation made easy

In addition to the built-in complex waveforms, you can use the 4084AWG & 4086AWG to generate custom arbitrary waveforms

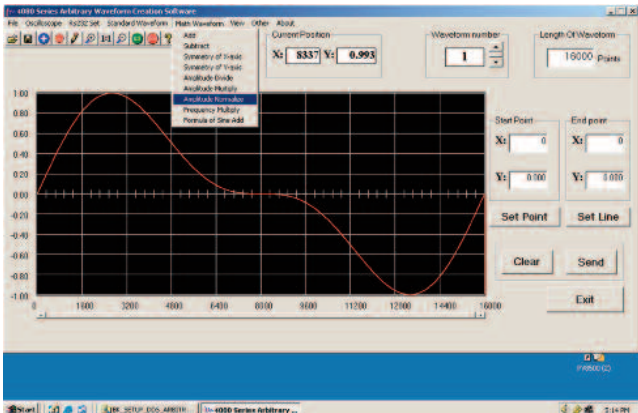

Fig1 Arbitrary Waveform Generation Software

with 10 bit vertical resolution, 16k memory depth and a sample rate of 200 MHz. Increase your productivity with the included intuitive Windows Software: Create and edit waveforms and download them to the instrument with a single click. Waveforms can be generated in many ways: Draw waveforms freehand, import them from a text file or start out with standard functions



and customize them with the provided math functions (fig1). Additionally, the software provides a direct interface to Tektronix® TDS1000, TDS2000 TPS2000 and TDS3000 series digital storage oscilloscope. Users can easily import waveforms originating from the DSO's display or internal memory and download and "replay" them on the instrument.

Versatile modulation and trigger capabilities

The generators provide extensive modulation capabilities including AM, FM, FSK, PSK, pulse modulation and linear/logarithmic sweep. Internal and external modulation sources, as well as internal, external and gated trigger sources are supported. Modulation parameters can be set precisely and are adjustable over a wide range. For instance, burst count is programmable in 1 burst increments up to 10000 bursts and burst phase is adjustable in 0.1° increments.

Convenient user interface and operation

You can adjust parameters via knob or numeric keypad. Enter amplitude values directly in Vpp, mVpp, Vrms, mVrms or dBm, and display the correct voltage by entering the actual output configuration used (terminated with 50 Ohm or open circuit). You can enter frequency in terms of frequency or seconds using time values s, ms, Hz, kHz or MHz. Submenus are used for modulation modes and other complex functions. The generators are fully programmable via the standard RS232 interface, using SCPI commands. The instrument also provides 10 memories to store and recall instrument settings. Additionally the current state is saved at power off and can be restored at power up.



Specifications

models

	4084AWG	4086AWG
Frequency Characteristics		
Sine	1μHz ~ 20MHz	1μHz ~ 80MHz
Square	1μHz ~ 20MHz	1μHz ~ 40MHz
All Other waveforms	1μHz ~ 100kHz	
Frequency Stability	± 1x10 ⁻⁶ (22°C ± 5°C)	
Resolution	1μHz	
Accuracy	≤ ± 5x10 ⁻⁴ (22°C ± 5°C)	
Data entry Units	s, ms, Hz, kHz, MHz	
Waveform Characteristics		
Main Waveforms (Sine, Square)		
Amplitude resolution	12 bits	
Sample Rate	200MSa/s	
Sine		
Harmonic Distortion of Sine Wave*	≤ - 50dBc (frequency ≤ 5MHz) ≤ - 45dBc (frequency ≤ 10MHz) ≤ - 40dBc (frequency ≤ 20MHz) ≤ - 35dBc (frequency ≤ 40MHz) ≤ - 30dBc (frequency > 40MHz)	
THD*	0.1% (20Hz ~ 100kHz)	
Square		
Rise and fall time*	≤ 15ns	
* = Note: Test conditions for harmonic distortion, sine distortion, rise/fall time Output Amplitude 2Vp-p, Environmental temperature: 25°C ± 5°C		
Others built-in waveforms		
27 build-in standard and complex waveforms	Sine, Square, Triangle, Positive Ramp, Falling Ramp, Noise, Pulse, Positive Pulse, Negative Pulse, Positive DC, Negative DC, Stair wave, Coded Pulse, Full wave rectified, Half-wave rectified, Sine transverse cut, Sine vertical cut, Sine phase modulation, Logarithmic, Exponential, Half-round, Sinx/x, Square root, Tangent, Cardiac, Earthquake, Combination	
Waveform Length	4096 dots	
Amplitude Resolution	10 bits	
Pulse		
Duty Cycle	0.1% ~ 99.9% (below 10kHz), 1% ~ 99% (10kHz ~ 100kHz)	
Rise/Fall Time	≤ 100ns (Duty Cycle 20%)	
DC signal characteristics		
DC range	≤ 10mV - 10V (high impedance)	
DC Accuracy	≤ ± 5% of setting + 10mV (high impedance)	
Arbitrary		
Non volatile memory	8 waveforms	
Waveform length	8 ~ 16000 points	
Amplitude resolution	10 bits	
Frequency range	1μHz ~ 100kHz	
Sample rate	200MSa/s	
Amplitude Characteristics		
Amplitude Range (open circuit)	Freq ≤ 40MHz: 2mV ~ 20Vpp, 1mV ~ 10Vpp (50Ω) Freq > 40MHz: 2mV ~ 4Vp-p, 1mV ~ 2Vpp (50Ω)	
Resolution	2μVpp (open circuit), 1μVpp (50Ω)	
Accuracy	± 1% + 0.2mV (sine wave relative to 1kHz)	
Stability	± 0.5 % / 3 hours	
Flatness		
For amplitude ≤ 2Vpp	± 3% (freq ≤ 5MHz), ± 10% (5MHz < freq ≤ 40MHz)	
For amplitude > 2Vpp:	± 5% (freq ≤ 5MHz), ± 10% (5MHz < freq ≤ 20MHz) ± 20% (frequency > 20MHz) ± 1dBm (frequency > 40MHz)	
Output Impedance	50Ω	
Output Units	Vpp, mVpp, Vrms, mVrms, dBm	
DC Offset Characteristics		
Offset Range (open circuit) (Freq ≤ 40MHz)	± 10Vpk ac+dc (Offset ≤ 2 x pk to pk amplitude) ± 2Vpk ac+dc (Offset ≤ 2 x pk to pk amplitude)	
Offset Resolution	2μV (open circuit), 1μV (50Ω)	
Offset Error	± 5% of setting + 10mV (Ampl. ≤ 2Vpp into open circuit) ± 5% of setting + 20mV (Ampl. > 2Vpp into open circuit)	
Modulation		
AM Characteristics		
Carrier Waveforms	Sine or Square	
Modulation Source	Internal or external	
Internal Modulating Waveform	Sine, Square, Triangle, Rising/Falling Ramp	
Frequency of modulating signal	100μHz ~ 20kHz	
Distortion	≤ 2%	

Modulation Depth	1% ~ 120%, 1% ~ 80% (frequency > 40MHz, Ampl > 2Vpp into open circuit)
Modulation Error	± 5% + 0.2% (100μHz < frequency ≤ 10kHz) ± 10% + 2% (10kHz < frequency ≤ 20kHz)
Max. Amplitude of ext. input signal	3Vp-p (-1.5V ~ +1.5V)
FM Characteristics	
Carrier Waveforms	Sine or Square
Modulation Source	Internal or external
Internal Modulating Waveform	Sine, Square, Triangle, Rising/Falling Ramp
Frequency of modulating signal	100μHz ~ 10kHz
Deviation	Max. 50% of carrier frequency for internal FM Max 100kHz (carrier frequency ≥ 5MHz) for external FM, with input signal voltage 3Vp-p (-1.5V ~ +1.5V)
FSK Characteristics	
Carrier Waveform	Sine or Square
Control Mode	Internal or external trigger (external: TTL level, low level F1, high level F2)
FSK Rate	0.1ms ~ 800s
PSK Characteristics	
Carrier Waveform	Sine or Square
PSK	Phase 1 (P1) and Phase 2 (P2), range: 0.0 ~ 360.0°
Resolution	0.1°
PSK rate	0.1ms ~ 800s
Control Mode	Internal or external trigger (external: TTL level, low level P1, high level P2)
Burst Characteristics	
Waveform	Sine or Square
Burst Counts	1 ~ 10000 cycles
Time interval between bursts	0.1ms ~ 800s
Control Mode	Internal, single or external gated trigger
Frequency Sweep Characteristics	
Waveform	Sine or Square
Sweep Time	1ms ~ 800s (linear), 100ms ~ 800s (log)
Sweep Mode	Linear or Logarithmic
Start/ Stop Frequency	Same as frequency range of Sine & Square
External trigger signal frequency	DC ~ 1kHz (linear) DC ~ 10Hz (log)
Control Mode	Internal or external trigger
Inputs/ Outputs	
Main Output	
Impedance	50Ω
Protection	Short circuit and overload protected
Output MOD OUT	
Frequency	100Hz ~ 20kHz
Waveform	Sine, Square, Triangle, Rising/Falling Ramp
Amplitude	5Vp-p ± 5%
Output Impedance	600Ω
Modulation IN	3Vpp = 100% Modulation
External Input Trig/FSK/Burst	Level - TTL
Universal Counter, Key Specs*	
Frequency Range	
Frequency Measurement	1Hz ~ 100MHz
Totalize mode	50MHz max
* For the full specification of the counter section refer to www.bkprecision.com	
General	
Power Supply	198~242V or 99~121V, Frequency: 47~ 63Hz
Power Consumption	< 35VA
State Storage Memory	
Storage Parameters	frequency, amplitude, waveform, DC offset values, modulation parameters
Storage Capacity	10 user configurable stored states
Dimensions (W x H x D)	10" x 3.93" x 14.56" (255 mm x 100 mm x 370 mm)
Weight	6.6lbs (3 kg)
Remote Interface	RS232
Safety designed according to	EN61010
EMC tested according to	EN55022, EN55024, EN61326, EN61000
Accessories	
One Year Warranty	
Accessories Included	BNC to alligator cable, BNC to BNC cable, RS232 communication cable, power line cord, test report, spare fuse, software installation disk.

NOTE: Specifications and information are subject to change without notice. Please visit www.bkprecision.com for the most current product information.

Function Generators

Programmable DDS Function Generator Series

Models 4084, 4085, 4086 & 4087

The B+K Precision® models 4084, 4085, 4086 and 4087 are high performance laboratory grade synthesized function generators with a wide frequency range of up to 120 MHz. Direct Digital Synthesis (DDS) techniques are used to create stable, accurate output signals for all 27 built-in standard and complex (arbitrary) waveforms. The generators produce high purity, low distortion sine waves, square waves up to 40 MHz and provide a stable output of very small signals down to the 1mV - 10mV range. The instrument also provides a built-in 100 MHz Universal Counter with frequency measurement and totalize function.

The versatility and capabilities of this series make it an ideal tool for many general-purpose test and bench applications or for use in Training and Education.

Versatile modulation and trigger capabilities

The generators provide extensive modulation capabilities including AM, FM, FSK, PSK, pulse modulation and linear/logarithmic sweep. Internal and external modulation

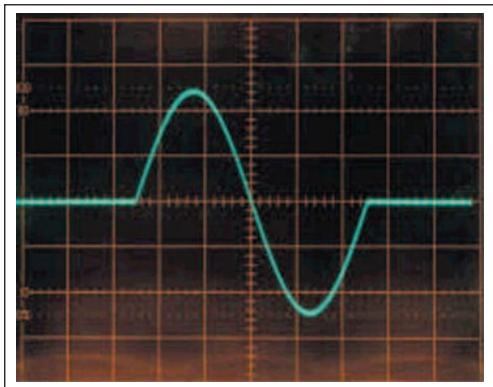

Fig1 Single cycle burst, start phase=0°



sources, as well as internal, external and gated trigger sources are supported. Modulation parameters can be set precisely and are adjustable over a wide range. For instance burst count is programmable in 1 burst increments up to 10000 bursts and burst phase is adjustable in 0.1° increments.

Convenient user interface and operation

You can adjust parameters via knob or numeric keypad. Enter amplitude values directly in Vpp, mVpp, Vrms, mVrms or dBm and display the correct voltage by entering the actual output configuration used (terminated with 50 Ohm or open circuit). You can enter frequency in terms of frequency or seconds using time values s, ms, Hz, kHz or MHz. Submenus are used for modulation modes and other complex functions. The generators are fully programmable via the standard RS232 interface, using SCPI commands. The instrument also provides 10 memories to store and recall instrument settings. Additionally the current state is saved at power off and can be restored at power up.



Specifications

models

	4084	4085	4086	4087
Frequency Characteristics				
Sine	1μHz ~ 20MHz	1μHz ~ 40MHz	1μHz ~ 80MHz	1μHz ~ 120MHz
Square	1μHz ~ 20MHz	1μHz ~ 40MHz	1μHz ~ 40MHz	1μHz ~ 40MHz
All Other waveforms	1μHz ~ 100kHz			
Frequency Stability	± 1x10 ⁻⁶ (22°C ± 5°C)			
Resolution	1μHz			
Accuracy	≤ ± 5x10 ⁻⁶ (22°C ± 5°C)			
Data entry Units	s, ms, Hz, kHz, MHz			
Waveform Characteristics				
Main Waveforms (Sine, Square)				
Amplitude resolution	12 bits			
Sample Rate	200MSa/s		300MSa/s	
Sine				
Harmonic Distortion of Sine Wave*	≤ - 50dBc (frequency ≤ 5MHz) ≤ - 45dBc (frequency ≤ 10MHz) ≤ - 40dBc (frequency ≤ 20MHz) ≤ - 35dBc (frequency ≤ 40MHz) ≤ - 30dBc (frequency > 40MHz)			
THD *	0.1% (20Hz ~ 100kHz)			
Square				
Rise and fall time*	≤ 15ns			
* = Note: Test conditions for harmonic distortion, sine distortion, rise/fall time Output Amplitude 2Vp-p, Environmental temperature: 25°C±5°C				
Others built-in waveforms				
27 build-in standard and complex waveforms	Sine, Square, Triangle, Positive Ramp, Falling Ramp, Noise, Pulse, Positive Pulse, Negative Pulse, Positive DC, Negative DC, Stair wave, Coded Pulse, Full wave rectified, Half-wave rectified, Sine transverse cut, Sine vertical cut, Sine phase modulation, Logarithmic, Exponential, Half-round, Sinx/x, Square root, Tangent, Cardiac, Earthquake, Combination			
Waveform Length	4096 dots			
Amplitude Resolution	10 bits			
Pulse				
Duty Cycle	0.1% ~ 99.9% (below 10kHz), 1% ~ 99% (10kHz ~ 100kHz)			
Rise/Fall Time	≤ 100ns (Duty Cycle 20%)			
DC signal characteristics				
DC range	≤ 10mV - 10V (high impedance)			
DC Accuracy	≤ ±5% of setting + 10mV (high impedance)			
Arbitrary				
Non volatile memory	8 waveforms			
Waveform length	8~16000 points			
Amplitude resolution	10 bits			
Frequency range	1μHz~100kHz			
Sample rate	200MSa/s			
Amplitude Characteristics				
Amplitude Range				
For all models	Freq ≤ 40MHz: 2mV ~ 20Vpp (open circuit), 1mV ~ 10Vpp (50Ω)			
4084, 4085, 4086	Freq > 40MHz: 2mV ~ 4Vp-p (open circuit), 1mV ~ 2Vpp (50Ω)			
4087	Freq > 40MHz: 0.1mV ~ 3Vpp (50Ω)			
Resolution	2μVpp (open circuit), 1μVpp (50Ω)			
Accuracy	± 1%+0.2mV (sine wave relative to 1kHz)			
Stability	±0.5 % /3 hours			
Flatness				
For amplitude ≤ 2Vpp	± 3% (freq ≤ 5MHz), ± 10% (5MHz < freq ≤ 40MHz)			
For amplitude > 2Vpp:	± 5% (freq ≤ 5MHz), ± 10% (5MHz < freq ≤ 20MHz) ± 20% (frequency > 20MHz) ± 1dBm (frequency > 40MHz)			
Output Impedance	50Ω			
Output Units	Vpp, mVpp, Vrms, mVrms, dBm			
DC Offset Characteristics				
Offset Range (open circuit)	Freq ≤ 40MHz: ± 10Vpk ac+dc (Offset ≤ 2 x pk - pk amplitude) Freq > 40MHz: ± 2Vpk ac+dc (Offset ≤ 2 x pk - pk amplitude)			
Offset Resolution	2μV (open circuit), 1μV (50Ω)			
Offset Error	± 5% of setting + 10mV (Ampl. ≤ 2Vpp into open circuit) ± 5% of setting + 20mV (Ampl. > 2Vpp into open circuit)			
Modulation				
AM Characteristics				
Carrier Waveforms	Sine or Square			
Modulation Source	Internal or external			
Internal Modulating Waveform	Sine, Square, Triangle, Rising/Falling Ramp			
Frequency of modulating signal	100μHz ~ 20kHz			

Distortion	≤ 2%
Modulation Depth	1% ~ 120%, 1% ~ 80% (frequency > 40MHz, Ampl > 2Vpp into open circuit)
Modulation Error	± 5%+0.2% (100μHz < frequency ≤ 10kHz) ± 10%+2% (10kHz < frequency ≤ 20kHz)
Max. Amplitude of ext. input signal	3Vp-p (-1.5V ~ +1.5V)
FM Characteristics	
Carrier Waveforms	Sine or Square
Modulation Source	Internal or external
Internal Modulating Waveform	Sine, Square, Triangle, Rising/Falling Ramp
Frequency of modulating signal	100μHz ~ 10kHz
Deviation	Max. 50% of carrier frequency for internal FM Max 100kHz (carrier frequency ≥ 5MHz) for external FM, with input signal voltage 3Vp-p (-1.5V ~ +1.5V)
FSK Characteristics	
Carrier Waveform	Sine or Square
Control Mode	Internal or external trigger (external: TTL level, low level F1, high level F2)
FSK Rate	0.1ms ~ 800s
PSK Characteristics	
Carrier Waveform	Sine or Square
PSK	Phase 1 (P1) and Phase 2 (P2), range: 0.0 ~ 360.0°
Resolution	0.1°
PSK rate	0.1ms ~ 800s
Control Mode	Internal or external trigger (external: TTL level, low level P1, high level P2)
Burst Characteristics	
Waveform	Sine or Square
Burst Counts	1 ~ 10000 cycles
Time interval between bursts	0.1ms ~ 800s
Control Mode	Internal, single or external gated trigger
Frequency Sweep Characteristics	
Waveform	Sine or Square
Sweep Time	1ms ~ 800s (linear), 100ms ~ 800s (log)
Sweep Mode	Linear or Logarithmic
Start/ Stop Frequency	Same as frequency range of Sine & Square
External trigger signal frequency	DC ~ 1kHz (linear) DC ~ 10Hz (log)
Control Mode	Internal or external trigger
Inputs/ Outputs	
Main Output	
Impedance	50Ω
Protection	Short circuit and overload protected
Output MOD OUT	
Frequency	100Hz ~ 20kHz
Waveform	Sine, Square, Triangle, Rising/Falling Ramp
Amplitude	5Vp-p ± 5%
Output Impedance	600Ω
Modulation IN	3Vpp = 100% Modulation
External Input Trig/FSK/Burst	Level - TTL
Universal Counter, Key Specs*	
Frequency Range	
Frequency Measurement	1Hz ~ 100MHz
Totalize mode	50MHz max
* For the full specification of the counter section refer to www.bkprecision.com	
General	
Power Supply	198~242V or 99~121V, Frequency: 47~ 63Hz
Power Consumption	<35VA
State Storage Memory	
Storage Parameters	frequency, amplitude, waveform, DC offset values, modulation parameters
Storage Capacity	10 user configurable stored states
Dimensions (W x H x D)	10" x 3.93" x 14.56" (255 mm x 100 mm x 370 mm)
Weight	6.6lbs (3 kg)
Remote Interface	RS232
Safety designed according to	EN61010
EMC tested according to	EN55022, EN55024, EN61326, EN61000
Accessories	
Included	BNC to alligator cable, BNC to BNC cable, RS232 communication cable, power line cord, test report, spare fuse
Optional	TLFG kit

One Year Warranty

NOTE: Specifications and information are subject to change without notice. Please visit www.bkprecision.com for the most current product information.

Function & Arbitrary Waveform Generators

31.5MHz Function Generator - Model 4071 21.5MHz Function Generator - Model 4070A

B+K Models 4070A & 4071 represents the finest single source for signal generation to date. Combining the latest DSP and DDS technologies, models 4070A & 4071 offers a number of operating modes, providing a versatile, cost-effective signal source. You will find both models are the best value and most capable instrument for any bench. Arbitrary Waveforms, Sweep Functions, Pulse, VCO, AM, FM, Phase Modulations, FSK and Burst Modes are all accessed quickly and easily from the front panel keypad. Being true 12 bit arbitrary generators, the 4070A & 4071 are stable, accurate and drift free. Unlike competitive models, the 4070A & 4071 generates data point independently of the repetition rate instead of from a simple look-up table. Custom design waveforms on a PC, or download from a spread sheet, oscilloscope or application program - the 4070A & 4071 will perform like no other signal source.

■ Arbitrary Waveform Generation

Design custom waveforms on your PC and download for generation 40 MS/s max update rate 12 bit resolution, 32K buffer. Arbitrary waveforms may be designed with a graphical Windows® based design tool, which is available for free download from www.bkprecision.com.

■ Function Generator

Generate Triangle, Ramp, Sinewave, and others.

■ Pulse Generator

Digital waveforms with an adjustable duty cycle.

■ High Stability Timebase

Guarantee ± 10 ppm over 32° to 104°F (0 to 40°C)

■ Modes

- Basic Sine/Square Wave
- Linear/Log Sweep (Free Run or Triggered)
- Internal/ External AM, FM, PM, SSB
- Internal/ External BPSK
- Internal/ External FSK (Ext FSK to 3MHz)
- Burst (Int/Ext trigger)
- DTMF Generation
- DTMF Detection
- Power Measurement
- Dualtone Generation
- Arbitrary Waveform
- Function Generator
- Pulse Generator

4070A, 4071 Standard Features

DC offset capability
TTL/CMOS sync output available in all modes
RS232 remote control (Easy to use) Code examples included.
External logic input for gating or output signal and triggering.
Easy software updates via Flash memory.
Configuration save/restore: 10 complete front panel setups.



4070A

The B+K Precision 4070A & 4071 represents a major breakthrough in signal generation and analysis. This versatile instrument has capabilities that allow the engineer to use it in a broad range of that include communications, radio, telephony, analog/digital circuit design and test.

The 4070A & 4071 are much more than a signal generator. Never before has so much versatility, capability and performance been packed into a single low-cost instrument. Its architecture is based on the latest advances in DSP and DDS technology which not only ensures calibrated and drift-free performance, but also gives the engineer signal analysis functions such as DTMF Detection and Power Level Measurement. The capabilities of the 4070A & 4071 can continually be enhanced and expanded by downloading software upgrades to internal Flash memory.

Both Models delivers clean, fully synthesized, modulated or unmodulated waveforms with 0.01Hz frequency resolution. User-friendly features include a large, easy-to-read illuminated LCD display which allows the user to see all modulation parameters simultaneously and a full numeric keypad and encoder which provide direct editing of each parameter. No confusing sub-menus!

The Arbitrary Waveform Generator allows you to design custom waveforms on your personal computer and download them to the 4070A & 4071 which generates them in real-time. The Arbitrary Waveform Generator system is also used to generate pulse waveforms with an adjustable duty cycle and a suite of pre-stored Function Generator waveforms. Arbitrary waveforms may either be designed with a graphical Windows®-based design tool or be generated point-by-point in a variety of data formats from your own application software. A floppy diskette with a data generator program, example waveforms, and a downloader utility are included with this option.

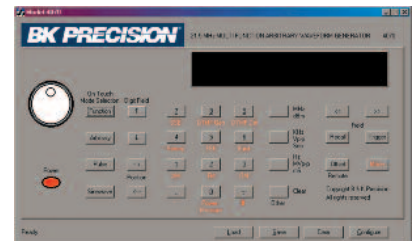

Control Panel

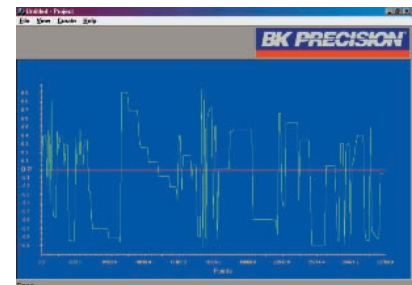

Freehand Waveform

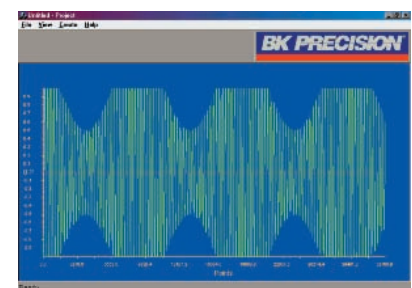

Amplitude Modulation Waveform

Specifications

models

4070A, 4071

MAIN OUTPUT	
Frequency:	DC to 21.5 MHz, 31.5 MHz (Model 4071), 0.01 Hz Steps
Level:	4 mVp-p to 10.000 Vp-p, 1mV steps (into 50Ω) or -44 dBm to +24 dBm, 0.1 dBm steps (into 50Ω) in Function, Arbitrary and Pulse modes. 4 mVp-p to 5.0 Vp-p, 1mV steps (into 50 Ω) or -44.0 dBm to +18 dBm, 0.1 dBm steps (into 50 Ω) in Sinewave, AM, FM, PM, SSB, Sweep, VCO, Burst, DTMF, Dualtone, BPSK, and FSK modes.
Level Accuracy:	±1%
Sinewave Distortion	<1%
Flatness:	± 0.2 dB (DC-10 MHz), ±0.4dB (10MHz - 21.5MHz) @5Vpp (into 50 Ω)
DC offset:	0V to ±6 V, 1 mV steps (into 50 Ω)
Output impedance:	50 Ω
Freq. accuracy:	±10 ppm (.001%), (@50Ω)
Phase Noise:	< -55 dBc in a 30 kHz band
Spectral Purity(@5Vpp):	DC to 100 kHz: > -50 dBc 100 kHz to 1 MHz: > -45 dBc 1 MHz to 12 MHz: > -40 dBc 12 MHz to 21.5 MHz: > -35 dBc
Distortion:	0.011 Hz to 100kHz ≤ 1%
SYNC OUTPUT	
Amplitude:	0V to +5V p-p (TTL/CMOS comp.)
Fall Time:	5 ns.
Rise Time:	< 8 ns. 10% to 90%
Output current:	±24 mA. max
RS232 PORT	
Asynchronous, no parity, 1 start bit, 1 stop bit.	
Baud rate:	Adjustable, 300 bps to 115,200 bps.
Remote operation from a terminal or host computer.	
EXTERNAL MODULATION INPUT	
Maximum full scale input:	±5 V (10 Vp-p)
Input Impedance:	30 kΩ
EXT. TRIGGER/GATING/FSK/BPSK INPUT	
Input impedance:	80 kΩ
Max. input level:	±10V
Max. gating freq:	3 MHz
EXT. ARB CLOCK INPUT	
Input level:	TTL/CMOS
Max. clock freq:	40 MHz
OPERATING MODES	
The carrier frequency for all modulation modes are 0 Hz to 21.5000000 MHz (Model 4070A), 0 Hz to 31.5000000 MHz (Model 4071), 0.01 Hz steps.	
All internal modulation frequencies are synthesized and are accurate to 0.01%.	
BASIC SINEWAVE (CW) MODE	
Output frequency:	0 Hz to 21.5 MHz, 31.5 MHz (Model 4071), .01 Hz Steps
FREQUENCY MODULATION (FM) MODE	
Int. modulation freq:	0 Hz to 10 kHz, 1 Hz steps
Ext. modulation freq:	DC to 35 kHz
Peak frequency deviation:	0 Hz to ±5.0 MHz, 1 Hz steps
PHASE MODULATION (PM) MODE	
Int. modulation freq:	0 Hz to 10 kHz, 1 Hz steps
Ext. modulation freq:	DC to 35 kHz
Peak phase deviation:	0 to ±180°, 1° steps
SWEEP MODE	
Start/Stop freq:	0 Hz to 21.5 MHz, 31.5 MHz (Model 4071), .01 Hz Steps
Linear or Log sweep. Up or Down sweep direction	
Continuous or Int/Ext Triggered sweep	
Sweep time:	1 ms to 60 sec. 1 ms steps.
VOLTAGE CONTROLLED OSCILLATOR MODE	
Endpoint frequencies:	0 Hz to 21.5 MHz, 31.5 MHz (Model 4071), .01 Hz Steps
Control input range:	-5.0V to +5.0V
Control signal bandwidth:	DC to 35 kHz
BURST MODE	
Continuous or Triggered from Front Panel, RS232, or Ext. TTL	
On Time:	1 ms to 99.999 Sec, 1 ms steps
Off Time:	0 ms to 99.999 Sec, 1 ms steps

Function & Arbitrary Waveform Generators

DUAL TONE MULTI FREQUENCY (DTMF) GENERATE MODE	
Dialing digits generated:	0 to 9, #, *, A, B, C, D
Duration:	1 ms to 10.000 Sec, 1 ms steps
Delay:	0 ms to 10.000 Sec, 1 ms steps
CUSTOM DUAL TONE GENERATE MODE	
Tone 1, Tone 2 Frequency:	DC to 10.000 kHz, 1 Hz steps
Phase Offset:	0 deg. to 359 deg., 1 deg. steps
Output ON time:	Cont. or 1 ms to 10.000 sec, 1 ms steps
Output OFF time:	0 ms to 10.000 sec, 1 ms step.
AMPLITUDE MODULATION (AM) MODE	
Int. modulation freq:	0 Hz to 10 KHz, 1 Hz steps
Ext. modulation freq:	DC to 35 kHz
Percentage modulation:	Variable 0% to 100%, 1% steps
SINGLE SIDEBAND (SSB) MODE	
Int. modulation freq:	0 Hz to 1.0 MHz, 1 Hz steps
Ext. modulation freq:	DC to 8500 Hz
Upper or Lower Sideband selectable	
FREQUENCY SHIFT KEYING (FSK) MODE	
Int. modulation freq:	0 Hz to 130 kHz, 1 Hz steps
Ext. modulation freq:	0 Hz to 3 MHz
Mark/Space freqs:	0 Hz to 21.5 MHz, 31.5 MHz (Model 4071), 0.01 Hz steps
DATA MODULATION MODE	
Baud Rate:	0 Hz to 130 kHz, 1 Hz steps
Message length:	1 to 960 bits. Nonvolatile storage: 10 locations
Mark/Space frequencies:	0 Hz to 21.5 MHz, 31.5 MHz (Model 4071), 0.01 Hz Steps
POWER & VOLTAGE MEASUREMENT MODE	
Input signal level:	±5 V max. (10Vp-p)
Input signal bandwidth:	DC to 50 kHz
Power calc. impedance:	Variable from 1 to 999 Ω
BINARY PHASE SHIFT KEYING (BPSK) MODE	
Int. modulation freq:	0 Hz to 130 kHz, 1 Hz steps
Ext. modulation freq:	0 Hz to 10 kHz
DUAL TONE MULTI FREQUENCY (DTMF) DETECT MODE	
DTMF digits detected:	0 to 9, #, *, A, B, C, D
Detection range:	10 Vp-p max., 20 mVp-p min.
Detection time:	100 ms
ARBITRARY WAVEFORM GENERATOR MODE	
Vertical Resolution:	12 bits
Sample Rate:	Variable from 0Hz to 40 Msamples/Sec. in .1 Hz steps
Sample Buffer Depth:	32,768 data points
Data Formats Supported:	Floating Point, Decimal, Hexadecimal, Integer, Binary, Digital, CSV and PRN formats
Nonvolatile waveform storage:	1 location, 32,768 points
FUNCTION GENERATOR MODE	
Waveforms:	Pos. Ramp, Neg. Ramp, Triangle, Pos. Exponential, Inverted Pos. Exponential, Neg. Exponential, Inverted Neg. Exponential, Random (noise), Sinewave
Repetition Rate:	0 Hz to 2 MHz in 1 Hz steps, all functions
Run Mode:	Continuous or Internal/External Triggered
PULSE GENERATOR MODE	
Frequency:	0 Hz to 2 MHz in 1 Hz steps
Duty Cycle:	Variable 0% to 100% in 1% steps
Tr, Tf:	≤ 40ns (10% to 90%, 1Vp-p) Variable in amplitude and offset, TTL/CMOS output also.
GENERAL	
Power:	100-240 VAC 47-63 Hz, 30W, 3 prong IEC conn.
Display:	2 line by 40 character, LCD, backlit.
Weight:	3.5 lbs. (1.6 kg)
Dimensions (H x W x L):	5.5 x 11.75 x 10.375" (140 x 298 x 264mm)
Operating Temperature:	32° to 104°F (0° to 40°C) ambient.
Stored instrument setups:	10, including 1 power-up state
Accessories	
SUPPLIED: Manual, Line Cord	
OPTIONAL: Carrying Case LC 40, TLFG Kit	

Two Year Warranty

For more product information please visit www.bkprecision.com

Function Generators

DDS Sweep Function Generator with Arbitrary Function Model 4045

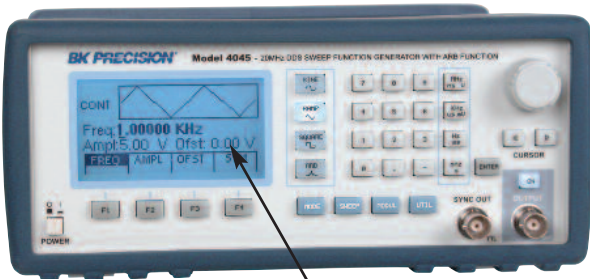

Graphical LCD Display

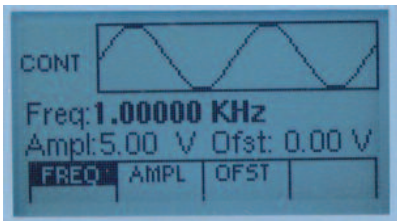

The model 4045 is a must have for anyone needing a feature packed precision generator. A menu-driven front panel operation with an easy-to-read graphic LCD display makes the 4045 easy to operate. Parameter changes and data entry can be made using the rotary knob or via the build-in RS-232C interfaces. Waveform editing can be done from scratch or by modifying standard waveforms.

The 4045 can generate standard or user-defined waveforms with crystal controlled sampling rates of up to 20MHz, 12 bit vertical resolution and up to 1,000 points. All waveforms are internally generated with amplitudes to 10Vp-p into 50ohm. An offset generator allows generation of signals with large offsets. A full range of triggering capabilities is available, including internal-external trigger source, gated and burst modes of operation.

- 20MHz Frequency Range (sine & square only)
- Sine, Square, Triangle & Arbitrary Waveforms
- Modulation in both AM & FM
- Lin or Log Sweep Function
- Bright Informative LCD
- RS-232C Interface

Specifications		model
		4045
FREQUENCY CHARACTERISTICS (STANDARD WAVEFORMS)		
Sine	0.1Hz to 20MHz	
Square	0.1Hz to 20MHz	
Triangle, Ramp	0.1Hz to 2MHz	
Accuracy	0.005 % (50 ppm)	
Resolution	6 digits or 10MHz	
ARBITRARY CHARACTERISTICS		
Waveform Length	2 points to 1,000 points	
Vertical resolution	12 bits	
Sampling rate	20 ns to 50 s	
Accuracy	0.005 % (50 ppm)	
Resolution	4 digits	
OUTPUT CHARACTERISTICS		
Amplitude Range	10mV to 10Vp-p into 50Ω	
Resolution	3 digits (1000 counts)	
Amplitude Accuracy	± 2% ± 20mV of the programmed output from 1.01V- 10V	
Flatness	0.5 dB at 1MHz, 1 dB to 20 MHz	
Offset Range	± 4.5V into 50Ω, depending on the Amplitude setting	
Offset Resolution	10 mV with 3 digits resolution	
Offset Accuracy	± 2% ± 10mV into 50Ω	
Output Impedance	50Ω	
Output Protection	The instrument output is protected against short circuit or accidental voltage practically available in electronic laboratories, applied to the main output connector	
WAVEFORM CHARACTERISTICS		
Harmonic Distortion	DC-20KHz, -55 dBc, 20KHz-100KHz, -50dBc 100KHz-1MHz, -40 dBc, 1MHz-20MHz, -30 dBc	
Spurious	DC-1MHz, <-60 dBc	
Square Rise/Fall Time	< 18ns (10% to 90%) at full amplitude into 50Ω	
Variable Duty Cycle	20% to 80% to 2MHz for Square and 10%-90% for Triangle	
Symmetry at 50%	< 1 %	
OPERATING MODES		
Continuous	Output continuous at programmed parameters.	
Triggered	Output quiescent until triggered by an internal or external trigger, then one waveform cycle is generated to programmed parameters, up to 10MHz trig rate for ARB waveforms and 1MHz in DDS mode	
Gate	Same as triggered mode, except waveform is executed for the duration of the gate signal. The last cycle started is completed.	
Burst	2 - 65,535 Cycles	
Trigger Source	Trigger source may be internal, external or manual. Internal trigger rate 0.1Hz - 1MHz (1us - 10 s)	
MODULATION CHARACTERISTICS		
Amplitude Modulation		
Internal	0.1 - 20KHz Sine signal or triangle waveform Variable modulation from 0% to 100% in 1% steps	
External	5 Vp-p for 100% modulation, 10KΩ input impedance, DC to 20KHz bandwidth.	
Frequency Modulation		
Internal	0.1 - 20KHz Sine signal or triangle waveform	
External	5 Vp-p for 100% deviation, 10KΩ input impedance.	
SWEEP CHARACTERISTICS		
Sweep Shape	Linear and Logarithmic, up or down	
Sweep Time	10 ms to 100 s.	
Sweep trigger	Internal, external, or continuous or burst	
INPUTS AND OUTPUTS		
Trigger In	TTL compatible. Max. rate 10MHz. Minimum width 50ns.	
Sync Out	TTL pulse at programmed frequency, 50Ω source impedance.	
Modulation IN	5 Vp-p for 100% modulation, 50KΩ input impedance. Dc to >20KHz minimum bandwidth.	
GENERAL		
Store memory	20 full panel settings at power-off	
Arbitrary memory	1,000 points in flash memory	
Dimensions (WxHxD)	8.4" x 3.5" x 8.3" (213mm x 88mm x 210mm)	
Weight	5.5 lbs. (2.5 Kg)	
Power	90V-264V, 30 VA max	
Temperature		
Operating	0°C to +50°C,	
Non-operating	-10°C to +70°C	
Accessories		Two Year Warranty
SUPPLIED: Manual, Line Cord		
OPTIONAL: TLFG Kit		

Function Generators

20MHz DDS Sweep Function Generator Model 4040DDS



The model 4040DDS is a low cost, full featured Direct Digital Synthesis (DDS) generator with a menu-driven front panel interface that includes a large, easy-to-read graphical LCD display. Waveform parameter changes and data entry can be made using the front panel rotary knob. The unit generates superb quality waveforms with high signal precision and stability. It provides sine & square wave outputs over the frequency range from 0.1 Hz to 20 MHz in one extended range (triangle/ramped wave outputs to 2MHz). A full range of triggering capabilities is available, including internal-external trigger source, gated and burst modes of operation.

- 20MHz Frequency Range (sine & square only)
- Sine, Square & Triangle
- Modulation in both AM & FM
- Lin or Log Sweep Function
- Adjustable Duty Cycle
- Adjustable DC Offset
- Bright Informative LCD

Specifications		model
		4040DDS
FREQUENCY CHARACTERISTICS (STANDARD WAVEFORMS)		
Sine	0.1Hz to 20MHz	
Square	0.1Hz to 20MHz	
Triangle , Ramp	0.1Hz to 2MHz	
Accuracy	0.01 % (100 ppm)	
Resolution	4 digits or 10mHz	
OUTPUT CHARACTERISTICS		
Amplitude Range	10mV to 10Vp-p into 50Ω	
Resolution	3 digits (1000 counts)	
Amplitude Accuracy	± 2% ± 20mV of the programmed output from 1.01V- 10V	
Flatness	0.5 dB at 1MHz, 1 dB to 20 MHz	
Offset Range	± 4.5V into 50Ω, depending on the Amplitude setting	
Offset Resolution	10 mV with 3 digits resolution	
Offset Accuracy	± 2% ± 10mV into 50Ω	
Output Impedance	50Ω	
Output Protection	The instrument output is protected against short circuit or accidental voltage practically available in electronic laboratories, applied to the main output connector	
WAVEFORM CHARACTERISTICS		
Harmonic Distortion	0-20KHz, -50 dBc, 20KHz-100KHz, -45dBc 100KHz-1MHz, -40 dBc, 1MHz-20MHz, -30 dBc	
Spurious	DC-1MHz, <-55 dBc	
Square Rise/Fall Time	< 20ns (10% to 90%) at full amplitude into 50Ω	
Variable Duty Cycle	20% to 80% to 2MHz for Square and 10%-90% for Triangle	
Symmetry at 50%	< 1 %	
OPERATING MODES		
Continuous	Output continuous at programmed parameters.	
Triggered	Output quiescent until triggered by an internal or external trigger, then one waveform cycle is generated to programmed parameters, up to 2MHz	
Gate	Same as triggered mode, except waveform is executed for the duration of the gate signal. The last cycle started is completed.	
Trigger Source	Trigger source may be internal, external or manual. Internal trigger rate 10us to 10s.	
MODULATION CHARACTERISTICS		
Amplitude Modulation		
Internal	Sine signal of 1000Hz Variable modulation from 0% to 100% in 1% steps	
External	5 Vp-p for 100% modulation, 10KΩ input impedance, DC to 20KHz bandwidth.	
Frequency Modulation		
Internal	Sine signal of 1000Hz	
External	5 Vp-p for 100% deviation, 10KΩ input impedance, DC to 20KHz bandwidth.	
SWEEP CHARACTERISTICS		
Sweep Shape	Linear and Logarithmic, up or down	
Sweep Time	10 ms to 50 s.	
INPUTS AND OUTPUTS		
Trigger In	TTL compatible. Max. rate 2MHz. Minimum width 50ns.	
Sync Out	TTL pulse at programmed frequency, 50Ω source impedance.	
Modulation IN	5 Vp-p for 100% modulation . 10KΩ input impedance. Dc to >20KHz minimum bandwidth.	
GENERAL		
Dimensions (WxHxD)	8.4" x 3.5" x 8.3" (213mm x 88mm x 210mm)	
Weight	5.5 lbs. (2.5 Kg)	
Power	90V-264V, 30 VA max	
Temperature		
Operating	0°C to +50°C,	
Non-operating	-10°C to +70°C	
EMC	According to EN55011 for radiated and conducted emissions.	
Electrical Discharge Immunity	According to EN55082	
Safety Specifications	According to EN61010	
Accessories		Two Year Warranty
SUPPLIED: Manual, Line Cord		
OPTIONAL: TLFG Kit		

Function Generators

10MHz DDS Sweep Function Generator Model 4017B



Up to 10MHz available on Sine, Square & Ramp waveforms

B&K Precision model 4017B is a true function generator in its line that offers DDS (Direct Digital Synthesis) technology allowing to generate very precise and accurate waveforms with little distortion.

- **Multi-function LCD displays all output parameters:**
 - Frequency
 - Level
 - Offset
 - Duty Cycle

- **Up to 10MHz available on Sine, Square & Ramp waveforms**

- **Frequency resolution down to 0.01Hz**
- **RS-232 Interface**
- **0 to 100% duty cycle**
- **Variable DC offset**

The 4017B enhances the performance achieved by its successful predecessor, BK Precision Model 4017A Sweep/Function Generator.

These performances are achieved by using direct digital waveform synthesis (DDS) techniques for generating high accuracy and precision frequencies. A high performance Digital Signal Processor (DSP) controls every aspect of the DDS system, and is used for precise generation and processing of waveforms. The 4017B has a vast number of applications in both analog and digital electronics, in the engineering, manufacturing, servicing, educational and hobbyist fields.

This versatile signal source is capable of generating waveform (such as sine, triangle and square), pulse generation (through variable symmetry) and frequency sweep. Additionally, the instrument provides a built-in frequency counter

Specifications		model
		4017B
Frequency Characteristics		
Waveforms	Sine, Square, Triangle, \pm Pulse, \pm Ramp	
Range	0.01Hz to 10MHz in 5 ranges	
Resolution	5 digits	
Variable Duty Cycle	0 to 100% cont variable	
Fine	\pm 5% of coarse setting	
Operating Modes	Normal, sweep, VCG	
Frequency Stability	Output will change less than 0.009% over 15-minutes after 1-hour warm-up	
Output Level Characteristics		
Impedance	50W \pm 10%	
Level	0.02 to 20 Vp-p Open circuit 0.01 to 10Vp-p into 50 W (Accuracy: \pm 50mVp-p)	
Amplitude	Variable	
Attenuation	2 Ranges one with a -20 dB (\pm 1 dB) and one without	
DC Offset	Preset: \pm 0.1 V typical Variable: \pm 10V open-circuit \pm 5 into 50 W	
SINE Wave		
Distortion	\leq 1% typical at 1kHz	
Flatness	\pm 5% \pm (.45 dB)	
Square wave		
Symmetry	0.1Hz to 100kHz < 2%	
Rise time	\leq 20 ns (10% to 90%)	
Triangle Wave	Linearity: \geq 98% to 100 kHz	
TTL Output		
Threshold Level	0.8V to 2.4V	
Rise time	\leq 25ns (10% to 90% of Threshold)	
Duty Cycle	50% typical	
CMOS Output		
Max. Frequency	10 MHz	
Level	4V to 14V \pm 0.5Vp-p (cont. variable 5MHz max.)	
Rise Time	\leq 120ns (10% to 90%)	
VCG (Voltage Controlled Generator)		
Input Voltage	0-10V \pm 1V causes a 100:1 frequency change	
Impedance	10k W \pm 5%	
Sweep Operation		
Mode	LIN/LOG	
Width	100:1 continuously variable, 3-digit resolution	
Rate	0.01s to 30s cont variable, 4-digit resolution	
Sweep Output	0 to 10Vpp (into 50W)	
Frequency Counter		
Range	5Hz to 100MHz (1 & 10S Gate) 50Hz to 100MHz (01S Gate) 100Hz to 100MHz (0.01S Gate)	
Accuracy	Time base accuracy + 1 count	
Time Base Accuracy	\pm 10ppm (23 $^{\circ}$ \pm 5 $^{\circ}$ C)	
Display	9 digit LED	
Aging	\pm 5ppm/year	
Input	50mVpp to 10Vpp	
External Input		
Power Source	110/220 VAC + 10% 50/60 Hz, internal jumper selectable	
Dimensions (HxWxD)	4.2 x 10.5 x 12.25" (107 x 267 x 311 mm)	
Weight	6 lbs. (2.7 kg)	
Accessories		Two Year Warranty
SUPPLIED	Output Cable with BNC to Alligator Clips, Instruction Manual (CD)	
OPTIONAL	TLFG Accessory kit	

Function Generators

DDS Function Generators

Models 4007DDS & 4013DDS



4007DDS

The models 4007DDS & 4013DDS are a versatile sweep function generators utilizing an advanced Direct Digital Synthesis (DDS) design. These units generate superb quality waveforms with high signal precision and stability. It provides sine & square wave outputs over the frequency range from 0.1 Hz to 7MHz (4007DDS), 0.1 Hz to 12MHz (4013DDS) in one extended range (triangle/ramped wave outputs to 100kHz for (4007DDS) & (triangle/ramped wave outputs to 1MHz for model 4013DDS). Front panel operation with an easy-to-read 4 digit LCD display makes these units easy to operate, they are the perfect instruments for educational, R&D, manufacturing test systems, and service and repair environments.

Parameter changes and data entry can be made using the front panel up or down keys and modified with the rotary knob. The sweep output waveforms can be linear or logarithmic, internally swept, up or down, over the full unit range. The sweep start and stop frequencies can be independently adjusted and the sweep rate can be set from 100ms to 30s. All waveforms are internally generated with amplitudes to 10Vp-p into 50 ohm. An offset generator allows generation of low amplitude signals with large offsets.

- **7MHz (4007DDS), 12MHz (4013DDS)**
Frequency Ranges (sine & square only)
- **Sine, Square, Triangle**
- **Line, Log Sweep Function**
- **Adjustable Duty Cycle & DC offset**

Specifications		models	
	4007DDS	4013DDS	
Waveforms			
Sine, square and triangle	0.1Hz to 7MHz	0.1Hz to 12MHz	
Operating Modes			
Continuous	Output continuous at selected frequency.		
Symmetry	Square symmetry is continuously adjustable from 15% to 85%.		
Sweep	The output waveform can be linear or logarithmic internally swept, up or down, over the full unit range. The sweep start and stop frequencies can be independently adjusted and the sweep rate can be set from 100ms to 30s.		
Frequency Characteristics			
Range	0.1 Hz to 7 MHz for Sine and Square waveforms. To 100 kHz for Triangle waveforms.		
Control	The frequency is selected with front panel up or down keys and modified with a rotary digital control.		
Display	Up to 4 digits with large, bright LCD, ranging units (MHz, kHz, Hz and mHz) and decimal point. Waveform accuracy is 0.01% (100 ppm).		
Output Characteristics			
Amplitude Range	Up to 10 Vp-p into 50 Ω (20 Vp-p into open circuit)		
Amplitude Control	> 20 dB continuously variable.		
Amplitude Attenuator	20 dB.		
Amplitude Flatness	± 1 dB to 7MHz.	± 1 dB to 12MHz.	
Offset Range	Variable up to $\pm 10V$ ($\pm 5V$ into 50 Ω). Absolute peak amplitude plus offset limited to $\pm 10V$ ($\pm 5V$ into 50 Ω).		
Output Impedance	50 Ω		
Output Protection	The generator main output is non-destructively protected against short circuit to ground or to any voltage practically available in electronic laboratories.		
Waveform Characteristics			
Harmonic Distortion	< -50 dBc, 0 - 20 kHz (< 0.3%) < -40 dBc, 20 kHz - 100 kHz < -35 dBc, 100 kHz - 1 MHz < -30 dBc, 1 MHz - 7 MHz		
Spurious	< -50 dBc, 0 - 1 MHz		
Triangle Linearity	> 99% to 100 kHz.		
Square Transition Times	< 25 ns (10% to 90%) at full output amplitude terminated into 50 Ω .		
Inputs and Outputs			
Sync Out	TTL level square wave at generator frequency, in phase with main output and 50 Ω impedance. Can drive > 20 TTL loads.		
General			
Operating Temperature	0°C to +50°C		
Power Requirements	100V - 240V, $\pm 10\%$, 48 - 66 Hz single phase, < 25 VA.		
Dimensions (WxDxH)	8.4" x 8.3" x 3.5" (213 x 210 x 88 mm)		
Weight	4.4 lbs. (2 kg)		
Regulatory Standards	IEC 1010-1, Insulation category II, Pollution Degree 2.		
EMC	EN50081-1 and EN50082-1.		
CE Labeled			
Notes: Specifications apply at 25 \pm 5°C ambient temperature and after 30 minutes warm up.			
Accessories		Two Year Warranty	
SUPPLIED: Instruction manual & power cord			
OPTIONAL: TLFG Accessory kit			

Function Generators



4040A

4017A

10 MHz Sweep/Function Generator with Digital Display

Model 4017A

- 0.1 Hz to 10 MHz
- Linear and log sweep
- 5 digit LED display
- All features of Model 4011A

20 MHz Sweep/Function Generator with Frequency Counter

Model 4040A

- 0.2 Hz to 20 MHz
- AM & FM modulation
- Burst operation
- External frequency counter to 30 MHz
- 5 digit LED display
- Plus all features of Model 4017A

Specifications		models	
	4040A	4017A	
Frequency Characteristics			
Waveforms	Sine, Square, Triangle, \pm Pulse, \pm Ramp		
Range	0.2 Hz to 20 MHz in 8 ranges	0.1 Hz to 10 MHz in 8 ranges	
Resolution	5 digits		
Tuning Range	10:1		
Fine	$\pm 5\%$ of coarse setting		
Variable Duty Cycle	15:85:15 cont variable		
Operating Modes	Normal, Sweep, VCG, AM, FM, burst	Normal, Sweep, VCG	
Output Characteristics			
Impedance	50 Ω $\pm 10\%$		
Level	20 V p-p Open circuit, 10V p-p into 50 Ω		
Amplitude	Variable, 20 dB range typical		
Attenuation	-20 dB ± 1 dB		
DC Offset	Preset ± 0.1 V typ Variable: ± 10 V open-circuit ± 5 into 50 Ω		
SINE Wave			
Distortion	$\leq 3\%$ typical at 1 kHz		
Flatness (Into 50 Ω)	$\pm 5\% \pm (.45 \text{ dB})$ 0.1 Hz to 10 MHz $\pm 20\% \pm (2.0 \text{ dB})$ 10 MHz to 20 MHz (4040A) @3V p-p		
Square wave			
Symmetry	0.2 Hz to 100 kHz <2%	0.1 Hz to 100 kHz <2%	
Rise time (Into 50 Ω)	≤ 30 nS		
Triangle Wave	Linearity: $\geq 98\%$ to 100 kHz		
TTL Output			
Level	0.8V to 2.4V		
Rise time	≤ 20 nS (Between 0.8V to 2.4V)		
Duty Cycle	50% typical		
CMOS Output			
Max. Frequency	2 MHz		
Level	4V to 14V ± 0.5 p-p cont. variable		
Rise Time	≤ 120 nS (Open circuit)		
VCG (Voltage controlled generator)			
Input Voltage	0-10V ± 1 V causes a 100:1 frequency change		
Impedance	10k Ω $\pm 5\%$		
Sweep Operation			
Mode	LIN/LOG		
Width	100:1 continuously variable		
Rate	20 ms to 2 s cont variable	0.5 s to 30 s cont variable	
Start/Stop Frequencies	Adjustable	NA	
Frequency Counter			
Accuracy	Time base accuracy ± 1 count		
Time Base Accuracy	± 10 ppm (23° $\pm 5^\circ$ C)		
Display	5 digit LED		
Mode	INT or EXT	INT	
External Input			
Frequency	5 Hz to 30 MHz	Does not apply	
Resolution	0.1, 1, 10, 100, 1 kHz		
Sensitivity	25mVrms		
Power Source	120/230 VAC $\pm 10\%$ 50/60 Hz, internal jumper selectable		
Dimensions	5.5 x 11.75 x 10.575" (140 x 298 x 264mm)	4.5x 11.75 x 10.575" (114 x 298 x 264mm)	
Weight	4.5 lbs. (2 kg)	4 lbs. (1.8 kg)	

Accessories

Two Year Warranty

SUPPLIED: Output Cable with BNC to Alligator Clips, Instruction Manual, Line Cord
OPTIONAL: Carrying Case (not included): LC 40, TLFG Kit

Specifications

	model	
	4040A	
AM MODULATION CHARACTERISTICS		
Source	Internal/ External	
Modulation Ratio	0 to 100%	
Int modulation	1 kHz	
Ext Modulation	DC to 500 kHz	
Ext Sensitivity	Less than 10V p-p for 100% modulation	
FM MODULATION CHARACTERISTICS		
Source	Internal, External	
Modulation Ratio	0 to 100%	
Deviation	0 to 5%	
INT Modulation	1 kHz	
Ext Modulation	DC to 500 kHz	
Ext Sensitivity	Less than 10V p-p for 100% modulation	
BURST CHARACTERISTIC		
Source	Internal, External	
Burst Width	Cont. variable from 5% to 90% of internal gating frequency	
Repetition Rate	0.5 Hz to 50 Hz, internal	
	DC to 500 kHz external	
External Level	TTL levels	
Burst Frequency	Determined by main generator frequency setting	

Function Generators

5 MHz Function Generator with Digital Display

Model 4011A

- 0.5 Hz to 5 MHz
- Sine, Square, Triangle, Pulse, & Ramp output
- Coarse and Fine tuning
- 4 digit LED display
- Variable duty cycle
- Variable DC offset



4011A

5 MHz Sweep Function Generator

Model 4012A

- 0.5 Hz to 5 MHz
- Sine, Square, Triangle, Pulse, & Ramp output
- Coarse and Fine tuning
- 4 digit LED display
- Variable duty cycle
- Variable DC offset
- Variable amplitude output plus 20dB attenuator
- 20Vpp output into open circuit (10Vpp into 50Ω)



4012A

2 MHz Function Generator

Model 4010A

- 0.2 Hz to 2 MHz
- Sine, Square, Triangle, Pulse, & Ramp output
- Variable duty cycle
- Variable DC offset



4010A

Specifications

	4011A, 4012A	models 4010A
Frequency Characteristics		
Waveforms	Sine, Square, Triangle, \pm Pulse, \pm Ramp	
Range	0.5 Hz to 5MHz	0.2 Hz to 2MHz
	in 7 ranges, 8 ranges(4012A) in 7 ranges	
Resolution	4 digits	NA
Dial Accuracy	NA	\pm 5% typical
Tuning Range	Coarse, 10:1	10:1
	Fine \pm 5% of coarse setting	
Variable Duty Cycle	15:85:15 Cont variable	15:85:15 cont variable
Operating Modes	Normal, VCG	Normal, VCG
Output Characteristics		
Impedance	50 Ω \pm 10%	
Level	20 V p-p Open circuit, 10V p-p into 50 Ω	
Amplitude	Variable, 20 dB range typical	
Attenuation	-20 dB \pm 1dB	
DC Offset	Preset \pm 0.1 V typ Variable: \pm 10V open-circuit \pm 5 into 50 Ω	
SINE Wave	Distortion: \leq 3% @ 1kHz Flatness: \leq 5% (.45 dB)	Distortion: \leq 4% @ 1kHz Flatness: \leq 5% (.45 dB)
Square Wave		
Symmetry	0.5Hz to 100KHz, 0.1Hz to 100 KHz(4012A), \leq 2%	
Risetime (Into 50 Ω)	\leq 20 nS, \leq 30 nS (4012A)	\leq 120 nS
Triangle Wave	Linearity: \geq 98% to 100 KHz, \geq 95% to 2 MHz	
TTL Output		
Level	0.8V to 2.4V	
Rise time (0.8V to 2.9V)	\leq 20 nS	\leq 50 nS
Duty Cycle	50% typical	
CMOS Output		
Max. Frequency	2 MHz	
Level	4V to 14V \pm 0.5 p-p cont. variable	
Rise Time	\leq 120 nS (Open Circuit)	
Input VCG		
Input Voltage	0-10V \pm 1V causes a 100:1 frequency change	
Impedance	10K Ω \pm 5%	
Sweep Operation(4012A)		
Mode(4012A)	LIN/LOG	NA
Width(4012A)	100:1 continuously variable	NA
Rate(4012A)	0.5 s to 2 s cont variable	NA
Frequency Counter INT		
Accuracy	Time Base Accy \pm 1 count	NA
Time Base Accuracy	\pm 10 PPM (23°C \pm 5°C)	NA
Display	4 digit LED	
Power Source	120/230 VAC \pm 10%, 50/60 Hz, internal jumper selectable	
Dimensions (H x W x D)	4.5 x 11.75 x 10.375" (114 x 298 x 264 mm)	
Weight	4 lbs (1.8 kg)	

Accessories

Two Year Warranty

SUPPLIED: Output cable with BNC to alligator clips, Instruction Manual, Line Cord
OPTIONAL: Carrying Case (not included): LC 40, TLFG kit

Function Generators

Multi-Function Generator with Power Supply Model 4051

The model 4051 is a programmable multifunction generator that is extremely versatile and affordable. It is the perfect instrument for R&D, Manufacturing Test Systems, Educational and Training applications, and Service and Repair. In addition to the standard features one would expect on a function generator, the Model 4051 adds an adjustable triple output switching power supply, universal logic probe, auto-ranging frequency counter and a digital voltmeter. All of these features allow the user to analyze and measure many aspects of an electronic circuit.

Five instruments integrated into one compact machine

- 20MHz Sweep Function Generator
- 35MHz Universal Logic Probe
- 80W Triple Output Switching Power Supply
- Auto-Ranging Frequency and Totalize Counter
- Auto-ranging Digital Voltmeter

Utilizing a standard 115VAC power source, B+K Precision's Model 4051 is capable of producing precision sine, square, triangle, +/- pulse, or +/- ramp waves over the 0.15Hz to 20MHz in 8 ranges. This encompasses subaudible, audio, ultrasonic and RF applications.

Extremely versatile, B+K Precision's new Model 4051 combines several functions such as waveform generation, pulse generation (through variable symmetry), an adjustable triple output switching power supply, universal logic probe, auto-ranging frequency counter and a digital voltmeter frequency sweep, into one device. The instrument also provides the added convenience of a built-in frequency counter. This permits more accurate determination of output frequency than is possible with a simple calibrated dial. Coarse and fine tuning controls permit precision setting of the output frequency. A continuously variable DC offset allows the output to be injected directly into circuits at the correct DC bias level.

Operating as a Sweep Generator, the Model 4051 offers linear or log sweep with variable sweep rate and adjustable sweep time. Variable symmetry of the output waveform converts the instrument to a Pulse Generator capable of generating rectangular waves or pulses, ramp or saw tooth waves, and slewed sine waves.



- Easy to learn user-friendly interface
- One-touch access to system operations
- Integrated instruments and unified system ground
- Auto-frequency locking capability
- Active system setting stored to working memory
- Storage system for back of system states
- High brightness back lit LCD display
- RS-232 serial port for remote operation
- Multi-function simultaneous operation
- Heat activated cooling fan

System integration features of the B&K model 4051

Eliminates Ground Loop Current

Save time, improve accuracy and make hassle-free measurement with the B&K 4051. All five of the B&K 4051's integrated instrument share one unified system ground, eliminating ground loop current

Auto Frequency Locking

Unlike conventional locking generators, the output frequency of the B&K 4051 can be automatically locked within ± 0.2 range at the tuned frequency without drift cause by temperature, moisture or component degeneration

Cost Effective and Compact

Combining the circuitry of the different instruments allows B&K to deliver all five for the price of one cost effective and compact package that will save money and save space on your test bench

Function Generators

Specifications

model

4051

Frequency Characteristics	
Wave forms	Sine, Square, Triangle, \pm Pulse, \pm Ramp
Range	0.15Hz to 20MHz in 8 ranges
Resolution	0.01, 0.1, 1, 10, 100Hz Display
Tuning Range	Coarse: 10:1, Fine: \pm 3% of Coarse Setting
Variable Duty Cycle	15:85:15 Continuously variable
Operating Modes	Normal, Sweep, VCG, AM, FM, Single Burst, Multiple Burst
Frequency Stability	\pm 0.2% of the tuning frequency
Output Characteristics	
Impedance	50 Ω \pm 10%
Level	200 mV to 20 Vp-p Open-circuit, 10 Vp-p into 50 Ω to 10 MHz
Amplitude Control	Variable, 20 dB range typical
DC Offset	Preset: \pm 0.10 V typical, Variable: \pm 10 V open-circuit, \pm 5 V into 50 Ω
Sine Wave	
Distortion	<1.0% THD from 10 Hz to 100 kHz
Flatness	\pm 3% (0.3 dB) 0.15Hz to 200kHz \pm 5% (0.45 dB) 200kHz to 10MHz \pm 20% (2.0 dB) 10MHz to 20MHz
Square Wave	
Symmetry	<2% 0.15Hz to 100kHz
Rise Time	\leq 20 ns
Overshoot & Undershoot	\leq 6%
Triangle Wave	
Linearity	98% up to 100 kHz
TTL Output (Open-Circuit Condition for Frequencies \leq 2 MHz)	
Max. Logic Low Level Voltage	\leq 0.4 V
Min. Logic High Level Voltage	\geq 2.6 V
Rise Time	\leq 15 ns
Duty Cycle	50% typical
CMOS Output (Open-Circuit Condition for Frequencies \leq 2 MHz)	
Level	Output from 3.0 V to 15.0 V \pm 0.5 Vp-p
Rise Time	\leq 120 ns
VCG (Voltage Controlled Generator) Input	
Input Voltage	0-10 V \pm 0.5 V causes a 10:1 frequency change
Impedance	10 k Ω \pm 5%
Sweep Operation	
Mode	LIN/LOG
Source	Internal, External
Width	10:1, continuously variable
Rate	10 ms to 1 sec, continuously variable
Sweep Output	0 to 2 V
Start/Stop Frequency	By digital setting
AM Modulation Characteristics	
Source	Internal, External
Modulation Ratio	5% to 100%
INT. Modulation	1 kHz
EXT. Modulation	DC to 500kHz
EXT. Sensitivity	Less than 10 Vp-p for 100% modulation
FM Modulation Characteristics	
Source	Internal, External
Deviation	0 to 5%
INT. Modulation	1 kHz
EXT. Modulation	DC to 500kHz
EXT. Sensitivity	Less than 10 Vp-p for 100% modulation
Burst Characteristics	
Mode	Multiple, Single, or Key controlled one shot
Source	Internal, External
Burst Width	Continuously variable from 5% to 90% of internal gating frequency
Repetition Rate	0.5Hz to 50Hz, internal or DC to 500kHz external
Burst Frequency	Determined by the main generator frequency setting. Tone burst is in integral cycles of gated frequency.
Frequency Counter (Display shown "EXT. CNTR")	
Range	3.0Hz to 35MHz Auto-ranging
Resolution	0.01, 0.1, 1, 10, 100Hz
Max. Display	6 digits
Input Port	Logic Probe or EXT. CNTR BNC Jack

Auto-Ranging Counter			
Input Characteristics			
Impedance	1 M Ω /100 pf		
Coupling	AC (Ext. counter BNC input)/DC (logic probe input)		
Max. Overload Protection	\pm 260 V AC/DC		
Sensitivity	\leq 0.45 Vrms		
Accuracy	Time base accuracy \pm 1 count \pm trigger		
Triggering Threshold	Selectable for TTL, CMOS, logic threshold or 0 - 3.5 V continuously adjustable triggering level.		
Low Frequency Counter (Display shown "EXT. CNTR TOTAL")			
Range	0.04 Hz to 3Hz		
Resolution	0.01, 0.001Hz		
Max. Display	4 digits		
Input Port	Logic Probe only		
Transition (Totalize) Counter (Display shown "TOTAL")			
Frequency Range	up to 5.0kHz		
Max. Display	6 digits		
Reset Key	"CAL"		
Input Port	Logic Probe for DC coupling or EXT. CNTR BNC Jack when frequency is greater than 3Hz.		
Auto-Ranging DVM			
Input Range	0 to \pm 2.500 V, \pm 25.00 V DC, \pm 250.0 V Auto-ranging		
Resolution	1 mV, 10 mV, 100 mV		
Accuracy	\pm 0.75%		
Input Protection	Max. \pm 260 V DC/AC		
Impedance	1 M Ω		
Max. Display	4 digits		
Universal Logic Probe			
Logic Threshold			
	TTL	CMOS	
High Threshold	2.0 V \pm 10%	70% Vdd* \pm 15%	
Low Threshold	0.8 V \pm 10%	30% Vdd* \pm 15%	
*Vdd is controlled by C-Level			
Max. Repetitive	35 MHz (With probe miniature clip to GND)		
Frequency Response			
Min. Single Pulse Detection	15 ns (With probe miniature clip to GND)		
Display Format	Logic High, Logic Low, Square clock, Positive Going Pulse, Negative Going Pulse, Tri-state.		
Triple Output DC Power Supply			
	Vcc	+Vs	-Vs
Output Voltage	5 V/3.3 V	0~+24 V	0~-24 V
Output Current			
Min.	5.0 A	1.5 A	.5 A*
Max.	6.5 A	2.0 A	1.5 A*
DVM display	3-digit	4-digit	4-digit
Overload Protection	Short Circuit, Over-current, Over-voltage, Reverse Polarity, Over-temperature		
Ripple & Noise	10 mVrms	10 mVrms	10 mVrms
Dual Tracking**	N/A	YES	YES
* For continuous operation, the output current of -Vs supply reduces as output voltage drops. (see 3.1.4 for limitations of the -Vs supply)			
** -Vs tracks +Vs or independent adjustment			
Physical Properties			
Dimensions	5.3" x 9.5" x 10.5" (135 x 241 x 267 mm)		
Shipping Weight	7.5 lbs (3.4 kg)		
Power Requirements	115 VAC or 230 VAC 10% 50Hz or 60Hz, Approximately		
Accessories			
SUPPLIED	Operational manual, AC power cord, BNC cable with clips, Logic Probe		
OPTIONAL	RS-232C D-sub 9-pin Male to Female interface cable, TLFG kit, LC 40 Carrying Case		

Pulse Generator

10 MHz Pulse Generator with 4-Digit LED Display

Model 4030

B&K Precision Model 4030 is a versatile signal source which combines four functions into one unit – waveform generation, pulse generation (through variable symmetry), frequency sweep operation, and triggered operation. The 4030 offers low rise and fall time pulsed signals up to 10MHz to meet many test and measurement applications.

Applications

With this versatility, it has a vast number of applications in both analog and digital electronics in the engineering, manufacturing, servicing, educational, and hobbyist fields.

B+K Precision's Model 4030 is capable of producing pulsed waveforms with variable symmetry and amplitude to test for a variety of applications including:

- Testing and troubleshooting digital logic circuits
- Interfacing between different logic families
- Testing response time of opto-isolators
- Testing shift registers.

Some of the unique features of the B+K Precision Model 4030 include:

- Manual mode that allows one pulse to be generated each time a pushbutton is pressed, making it convenient for stepping a circuit, one pulse at a time.
- Normal or inverted polarity pushbutton.
- External triggering mode allows pulse generator to be synchronized to an external signal, such as external clock frequency signal.
- Separate trigger output is also available. This output is commonly used to trigger an oscilloscope, so that the leading edge of a pulse can be viewed but the output can be used as a simultaneous pulse output with independently variable pulse width.



Specifications		model
	4030	
Frequency Range		
Internal	0.1Hz to 10MHz in 8 decade ranges & variable	
X'Tal Spot freq.	1Hz, 10Hz, 100Hz, 1KHz, 10KHz, 100KHz, 1MHz, 10MHz.	
Rate	100nS – 0.1S	
Width	50nS-50mS (6 decade ranges & variable)	
Delay	0-2uS variable w.r.t. trigger	
Stability X'tal Mode	200 ppm	
Warm up Time	30 minutes	
Triggering		
Internal	0.1Hz to 10MHz	
External	10Hz to 10MHz	
Manual	1 pulse per sec	
Ext. Trig-Input	+1V to +10V p-p sine & square waveform	
Frequency Counter		
Range	0.1Hz to 10MHz	
Display	4 digit counter with internal, External and Auxiliary mode	
Display Accuracy	±0.5% ±1 count	
Output Polarity	Normal/Inverting	
Output		
Pulse Out	0.5V-5V at 50W	
Impedance	50Ω	
Rise & Fall Time	10μS approximately	
Output Terminal	BNC Connector	
Power Supply		
Voltage	115/230V AC +10%, 50/60Hz	
Consumption	10VA	
Physical		
Dimensions (WxHxD)	11" x 3.7" x 12.2" (279 x 94 x 310 mm)	
Weight	5.1 lbs. (2.27 kg)	
Accessories		One Year Warranty
SUPPLIED: BNC to BNC cable, 50Ω Terminator & Instruction Manual, Line Cord		
OPTIONAL: BNC to BNC cables, CC 41A		

4MHz Function Generators



4001A



4003A

4MHz Sweep Function Generator Model 4001A

Models 4001A and 4003A are 4MHz Sweep Function Generators. The sweep function offers linear or log sweep with variable sweep rates and widths. The model 4003A has the addition of a 60MHz five digit external frequency counter.

Common Features

- Generates Sine, Triangle & Square waveforms from 0.5Hz to 4MHz
- 20Vpp output into open circuit (10Vpp into 50Ω)
- TTL Output <25nS
- 100% DC offset
- Variable amplitude output plus 20dB attenuator

4003A Additional Features

- CMOS adjustable level output
- 5 digit LED display
- Voltage Control Generator (VCG) input

Specifications		model
	4003A	
COUNTER		
Display	5 digit 0.36 Red LED display with Autorange	
Gate Time	Auto Select (0.25S~10S)	
Resolution	0.001Hz	
MODE	INT Function Generator/EXT Counter	
Accuracy	± time Base Accuracy ± 1 count	
Time Base	20MHz (+ 10PPM)	
Frequency Range	0.2Hz~60MHz	
Sensitivity	25mVrms at 1MHz	
Max Input	250Vrms	
Input Impedance	1MΩ +2%	

4MHz Function Generator with 5 Digit Red LED Model 4003A

Specifications		models	
	4001A	4003A	
MAIN OUTPUT			
Frequency Range	0.5Hz to 4MHz in 6 Ranges		
Waveforms	6 Waveforms (Sine, Square, Triangle, Ramp, +Pulse, -Pulse)		
Amplitude	20Vp-p in to a Open (10Vp-p in to 50W)		
Attenuator	0dB, -20dB (+2%)		
Output Impedance	50W (+2%)		
DC Offset	+10V (pull ADJ.)		
Distortion	<2%, 1Hz to 100KHz		
Rise/Fall Time	<90nS (20Vp-p, No Load)		
V.C.F. Input	0 to +10V control		
SYNC OUTPUT			
Rise Time	<40nS (Into 50Ω)		
Level	>3Vp-p (open)		
Waveforms	Pulse		
SWEEP			
Mode	Linear/Log Sweep		
Width	>100:1 Continuously Variable		
Rate	From 10mS to 5S Continuously Variable		
Sweep Output	10Vp-p (open)		
Output Impedance	1KW +2%		
Power Source	AC 115VAC/230VAC +10%, 50/60Hz, 25W		
Dimensions (H x W x D)	10.83" x 3.6" x 11.8" (275 x 90 x 300mm)		
Weight Approx.	4.9lbs (2.2kg)	5.5lbs (2.5kg)	
Accessories			
One Year Warranty			
SUPPLIED: Instruction Manual & BNC Cable CC-21, Line Cord			
OPTIONAL: TLFG Kit, CC-41A Cable.			

Signal Generator

10MHz Handheld Sine & Square Wave Signal Generator Model 3003

Model 3003 Hand-held 10MHz Sine & Square Wave Generator is a small size and lightweight portable Signal Generator that makes it practical for use where a traditional sized meter may be too cumbersome. Model 3003 has a frequency accuracy of 0.02% with 0.1Hz stability making it ideal for use by schools, research & development departments, hobbyists, and field test technicians.

The Model 3003 offers the user an outstanding list of features including:

- Low Cost
- Small Size (2.1" x 3.6" x 6.0")
- Light Weight (0.80 lbs. without battery)
- Produces clean sine and square waves
- Variable amplitude control for sine wave
- Eight push wheel switches to set frequency
- External AC adapter (6V – 9VDC, 150mA, 6.5mm x 2.1mm center pin +), or one standard 9V battery
- 0.1Hz stability
- Low battery indicator

The Model 3003 Signal Generator is a cost-effective signal source. Its architecture is based upon the latest advances in signal generation technology. The model 3003 delivers clean and accurate DC to 10MHz waveforms with frequency accuracy of 0.02% and 0.1Hz frequency resolution. Eight (8) push wheel switches enable the user to quickly and easily set the frequency.



Specifications		model
		3003
Frequency Characteristics		
Waveforms		Sine, Square
Range		DC to 9.999999MHz, 0.1Hz steps
Accuracy		0.02%
Sine Wave Output		0 – 4.5Vp-p (no load) Variable amplitude control
Output impedance		50 Ω
Square Wave Output		5Vp-p (no load)
Duty Cycle		50% typical
Output impedance		50 Ω
Power		An external AC adapter (6V - 9V DC 150mA 5.5mm x 2.1mm center pin+) or one 9V battery
Dimensions		1.5" x 3.8" x 5.7" (38 x 97 x 145 mm)
Weight		2 lbs. (0.9 kg)
Accessories		One Year Warranty
SUPPLIED: User Manual & AC Adapter		
OPTIONAL: BNC Cable CC-21		

Optional Accessory



BNC Cable CC-21

Square wave

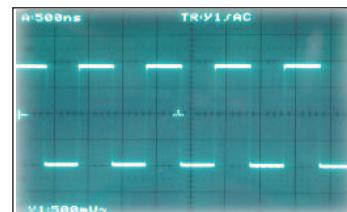

Sine wave

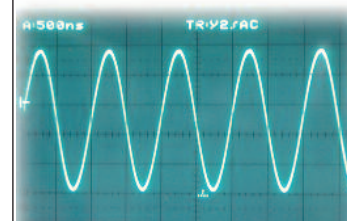

RF / Audio Generators



3001

20 Hz-150 kHz Sine/Square Wave Audio Generator Model 3001

- Sine and square wave generator
- 20 Hz to 150 kHz in 46 steps
- Low distortion R-C oscillator
- Variable output control
- Compact, fully portable, light weight
- Low battery indicator

Specifications

	3001	model
Frequency Range	x1 range 20 Hz to 1.5 kHz (23 steps), x100 range 2 kHz to 150 kHz (23 steps)	
Accuracy	20 Hz through 100 kHz ($\pm 3\%$ or less), 120 kHz and 150 kHz ($\pm 5\%$ or less)	
Output Control	0dB/-20dB attenuator switch and variable amplitude control	
Output impedance	approx. 600 Ω	
SINEWAVE CHARACTERISTICS		
Output Voltage	> 1.2V rms at max. setting (no load)	
Output Flatness	(Short term) 20 Hz to 150 kHz ± 0.5 dB (reference frequency 1 kHz)	
Distortion	200 Hz—15kHz 0.5% (THD) or less, 50 Hz—28 kHz 0.1% (THD) or less, 20 Hz—100kHz 0.3% (THD) or less	
SQUARE WAVE CHARACTERISTICS		
Output Voltage	> 5V p-p at maximum setting	
Rise and Fall Time	Less than 0.5microseconds	
Sag	Less than 5% at 20 Hz (DC coupled)	
Over Shoot	<2% from maximum output, to 50mV p-p	
Duty Ratio	50% $\pm 5\%$	
SYNC OUTPUT CHARACTERISTICS		
Output Voltage	> 1.2V rms (no load)	
Output Impedance	1k Ω $\pm 5\%$	
Other specifications same as sinewave characteristics		
GENERAL INFORMATION		
Operating Temperature	0°C to +50°C; specifications apply from 10°C to 30°C, <80% R.H.	
Storage Temperature	-20°C to +60°C, without battery	
Power Requirements	9V battery NEDA 1604A	
Battery Life	35 hours typical with Alkaline	
Battery Indicator	LED indicates low battery	
Dimensions (HxWxD)	6 x 3.3 x 0.9" (150 x 82 x 21mm)	
Weight	7 oz. (200 g) including battery	

Accessories

One Year Warranty

SUPPLIED: Two standard banana plug to insulated clip test leads, 9V battery, manual
OPTIONAL: TL 5A, CC 130



2005B

150 MHz RF Signal Generator Model 2005B

- 100 kHz to 150 MHz on six bands
- Output to 450 MHz on harmonics
- AM modulation, internal or external
- Frequency monitor output for external frequency counter
- Step and variable attenuation

Specifications

	2005B	model
MAIN OUTPUT		
Frequency Range	100 kHz to 150 MHz (up to 450 MHz on third harmonics) A) 100 kHz-300 kHz B) 300 kHz-1 MHz C) 1 MHz-3.2 MHz D) 3 MHz-10 MHz E) 10 MHz-35 MHz F) 32 MHz-150MHz (96-450 MHz on harmonics)	
Dial Accuracy	$\pm 3\%$	
RF Output Level	Continuously variable. Step attenuator provides approximately 20 dB of attenuation	
Maximum Output	Approximately 100 mV rms to 35 MHz. Continuously variable in hi or lo step, at least 20 dB range of adjustment	
FREQUENCY MONITOR OUTPUT		
Frequency	100 kHz to 150 MHz	
Level	50 mV rms min. fixed, unmodulated signal	
AMPLITUDE MODULATION		
Internal	Frequency 1 kHz; level continuously variable. Modulation signal available at front panel jack; fixed 1 V rms (min) into approx. 10 k Ω	
External	Frequency 50 Hz to 20 kHz	
Sensitivity	Approximately 100 mV rms	
POWER SOURCE	120/220/240V $\pm 10\%$, 50/60 Hz	
GENERAL		
Dimensions (HxWxD)	5.91 x 9.84 x 5.12" (150 x 250 x 130 mm)	
Weight	5.5 lbs. (2.5 kg)	

Accessories

One Year Warranty

SUPPLIED: BNC to Insulated Clip Output Cable, Detachable Power Cord, Manual
OPTIONAL: CC-21

Digital Multimeters & Clamp-On Meters



SELECTION GUIDE

	DCV Accuracy (%)	Display Count	Analog Bar Graph	Auto/Manual Ranging	Manual Ranging	True RMS	Min/Max Hold	Peak Hold	Data Hold	Memory	Capacitance	Frequency	Logic Level	Transistor Gain (hFE)	Temperature	Relative Mode	dBm Measurement	Max. Current Range (Amps)	Transient & Overload Protection	Battery Life (Hours)	Auto Power Off	Drop Resistant Case	Water Resistant	Rubber Boot	Model	Catalog Page	
Test Bench®	0.5	3999			√		√				√	√	√	√				20	√	200	√	√				388B	58-59
	0.25	3999	√	√			√		√	√	√	√				√		20	√	200	√	√	√			389A	
	0.1	3999	√	√			√		√	√	√	√			√	√		20	√	200	√	√				390A	
	0.05	19999			√	√			√			√	√					20	√	200	√	√	√			391A	
Survivor®	0.5	1999			√													20	√	250	√	√	√	√		2860A	55
Dual Display RS-232	0.06	51000	√	√		√	√	√	√		√	√						10		80				√		2880B	56-57
	0.06	51000	√	√		√	√	√	√		√	√			√	√	√	10		80				√		2890A	
Tool Kit®	0.5	1999			√						√							10	√	200		√		√		2703B	60-61
	0.5	1999			√						√	√						10	√	200		√		√		2704B	
	0.5	1999			√						√	√		√	√			10	√	200		√		√		2706A	
	0.5	1999			√						√	√	√	√				10	√	200		√		√		2707A	
Mini-Pro®	2.0	1999			√													10		200						2405A	62-63
	1.2	3200	√	√														10		200						2407A	
	2.0	1999			√													10		200						2408	

Multimeters

SELECTION GUIDE

	DCV Accuracy (%)	Display Count	Analog Bar Graph	Auto/Manual Ranging	Manual Ranging	True RMS	Min/Max Hold	Peak Hold	Data Hold	Capacitance	Frequency	Logic Level	Relative Mode	dBm Measurement	Max. Current Range (Amps)	Transient & Overload Protection	Battery Life (Hours)	Auto Power Off	Model	Catalog Page
Bench	0.02	50,000		√		√	√		√		√		√	√	20		45		5491A	
	0.012	120,000		√		√	√		√		√		√	√	20		1000		5492	66-67
	0.1	20,000		√		√									20	√	200		2831D	65
Clamp-On	1.0	10000		√				√	√						100		45	√	316	
	N/A	2000		√					√						600		1000	√	312B	
	1.0	10000		√				√	√						600		50	√	313A	70
	1.0	3999	√	√		√	√	√	√	√					600	√	200	√	325	
	0.5	2000							√						1000		500		330B	
	0.5	3200	√					√	√		√				1000		500	√	350B	
	0.8	2000						√	√						2000		150		367A	68-69
0.5	4000	√			√	√	√	√	√	√		√		1000		500	√	369B		
Analog	3%											√		√	12		200		114B	71
	5%														0.25		200		117B	
Pocket	1.3	3200	√	√					√	√					N/A	√	250	√	2700	64

For the right DMM please see our Multimeter Selection Tool on the Web - www.bkprecision.com

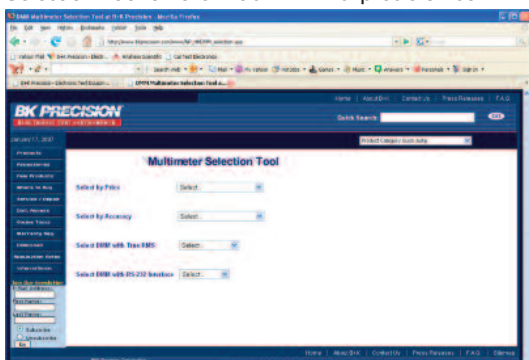

AC/DC Milliamp Clamp Meter

Measures Current Levels More Than 10X Lower Than Traditional Sized Meters

Model 316 portable, battery-powered AC/DC milliamp clamp meter measures current levels more than ten times lower than traditional sized meters, which can only measure current levels down to around five amps. Designed for evaluating and repairing electronic equipment, it is suited for applications where a traditional sized meter may be too cumbersome to use



Multimeters

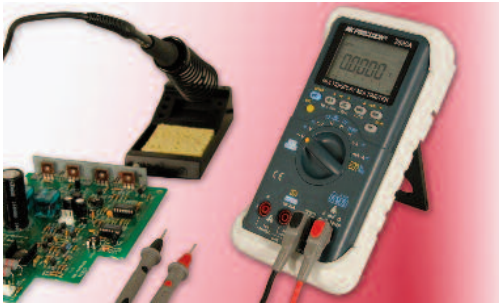

Multimeter Use

Multimeters are test instruments designed to perform more than one test parameter.

A basic multimeter provides three measurements:

- Voltage (AC and DC)
- Resistance (in ohms)
- Current (AC and DC)

Multimeters may also include other test parameters such as:

- Continuity
- Diode test
- Capacitance measurement
- Frequency measurement
- dBm measurement
- Transistor gain (hFE)
- Logic level

You need to review the complete test parameters for the multimeter you are considering.

The selection chart on page 52-53 provides a quick reference for this information.

Digital vs. Analog

You will notice that there are many digital multimeters on the market from which to make a selection.

What's the difference?

A digital display meter shows you a direct reading of the measurement being made. You do not have to make an interpretation of the reading.

An analog display meter is sometimes called a "swing needle" meter. As a measurement is being made, you have to see where the needle sets and then make an interpretation of the scale under the needle. Sometimes "parallax" (side viewing of the meter scale) may cause a misinterpretation of the meter reading. A mirrored scale on the analog meter solves this problem to some extent.

Analog meters have advantages by showing an "instant" change in reading. Due to the sampling rate of digital meters, change in reading may not be picked up as quickly. A solution to this problem was found by including an analog bargraph on a digital display meter. Some digital meters have this "analog" feature in them. Again, check the selection chart on page 52-53 for this information.

Accuracy and Resolution

If your accuracy requirements are critical for design or service, you need a high accuracy, high resolution meter. If your measurements are general purpose in nature, such as just checking voltages or continuity of a wire, an average meter (0.5% - DC volt accuracy) would fit your needs. No one but you will know the accuracy required for your measurement.

What is True RMS?

With the amount of non-sinusoidal power on AC power lines caused by uneven loads (motor controllers, personal computers, fax machines, computer printers, fax) you need a True RMS meter to make accurate measurements of AC Voltage or current. Some meters also include selectable AC or AC & DC True RMS measurements which provide the most complete accuracy measurements.

Ruggedized Construction

Some meters are used in the relatively calm environment of the test bench, while other meters' fate is in the real world of field service, plant maintenance, and MRO. You can select from any DMM series - ruggedized, water resistant meters

Budget considerations

B+K Precision offers a complete range of multimeters that will meet your testing, accuracy and budget parameters. Answer these questions:

Where will you be using the meter?

(on the bench, in the field, or both)

What type of measurements will you be making? (consider present and future needs)

What kind of accuracy will you require?

(consider present and future needs)

Review the selection chart on page 52-53 for a preliminary selection. Then turn to the specific model number page for complete specifications.

Survivor® Multimeter



The "Survivor" name says it all!

Excellent meters for most jobs that require flexibility, accuracy and speed. Value packed features make these meters a must in every Tool Kit.

Model 2860A

- Heavy Duty 1500 VDC rating
- Ruggedized construction
- Includes rubber boot
- Withstands 5-foot drop
- Extra large, high contrast LCD display
- Gasket sealed against dirt and contaminant
- Water resistant
- High energy fused on all current ranges
- Auto power off saves batteries
- Built in probe holders
- Non-slip grip
- Extensive overload protection
- 0.5% DCV accuracy
- Manual ranging
- 3 1/2 digit, 2000 count
- Large 0.8" LCD display

Specifications

	2860A	model
DC Volts	Manual ranging	
Ranges	200mV, 2V, 20V, 200V, 1500V	
Resolution	100µV, 1mV, 10mV, 100mV, 1V	
Accuracy	±(0.5% rdg + 1 dgt)	
Overload protection	1500V peak	
Input Impedance	10MΩ	
AC Volts	Manual ranging	
	avg. responding, rms reading	
Ranges	200mV, 2V, 20V, 200V, 1000V	
Resolution	100µV, 1mV, 10mV, 100mV, 1V	
Accuracy	±(1.25% rdg + 4 dgt)	
Frequency Response	40Hz - 500Hz	
Overload Protection	1500V peak	
Input Impedance	10MΩ	
Current	Manual ranging	
	AC avg. responding, rms reading	
Ranges	200µA, 2mA, 20mA, 200mA, 20A*	
Resolution	0.1µA, 1µA, 10µA, 100µA, 10mA	
Accuracy (DC)	±(1.0% rdg + 1 dgt), ±(2.0% rdg + 3 dgt) for 20A	
Accuracy (AC)	±(1.5% rdg + 3 dgt), ±(2.5% rdg + 4 dgt) for 20A	
Frequency Response	40Hz-500Hz	
Overload Protection	High energy 600V, 1A full for µA/mA, High energy 600V, 15A for 20A	
Resistance	Manual ranging	
Ranges	200Ω, 2kΩ, 20kΩ, 200kΩ, 2MΩ, 20MΩ	
Resolution	0.1Ω, 1Ω, 10Ω, 100Ω, 1kΩ, 10kΩ	
Accuracy	±(0.75% rdg + 1 dgt) ±(1.5% rdg + 5 dgt) for 20MΩ	
Overload Protection	600V peak	
Diode Check	Tested at 1.5mA, 3.3V max typical tested at 1mA 3.2V max typical	
Continuity	Beeper sounds below 100Ω approx.	
Display	0.8" LCD, 1999 count	
Sampling rate	2.5 /sec.	
Operating Temperature	32° to 122°F (0°C to 50°C), <80% RH	
Power	Single 9V battery	
Battery life	250 hrs type (alkaline)	
Auto power off	Approx. 30 min.	
Dimensions (H x W x D)	6.88 x 3.5 x 1.5" (175 x 89 x 38mm)	
Weight	12 oz. (353g)	

Accessories

Five Year Warranty

SUPPLIED: Battery, test leads, rubber holster, manual
 OPTIONAL: TL 1 Replacement Test Leads, TL 2A Deluxe Test Leads, TL 3 Accessory Tip Kit (for TL 2A), TL 130A General Purpose DMM Kit, PR 28A High Voltage Probe, CP 3 AC/DC Current Clamp Adapter, Carrying Case (not included): LC 29B

*10 A continuous, 20A for 30 seconds max.

Dual Display 51,000 Count Multimeters

Dual Display 51,000 Count DMM Models 2880B & 2890A

Model 2890A is a Dual Display 51,000 Count DMMs with exceptional accuracy and functionality. It offers superb performance with many features that are useful for trouble shooting electronic and electrical circuits or to test and evaluate circuits in a field service application.

Common Features:

- True RMS ACV and ACA
- AC+DC True RMS (2890A only)
- 5 Digit LCD for both the primary and secondary displays
- 21 Segment analog bar graph
- Automatic polarity indicator
- 0.025% Basic DCV accuracy (0.03% for 2880B)
- Resistance measurements
- Conductance measurements up to 50nS with 0.01nS resolution
- Capacitance measurement
- Frequency with ACV measurement
- Data Hold
- dBm Measurement
- REL Mode
- 1ms Peak Hold for glitch capture
- Back lit LCD (2890A only)
- Frequency counter up to 20MHz (2890A only)
- Square Wave output with 28 frequency ranges and adjustable duty cycle (2890A only)
- Conforms to IEC-1010-1 600V CAT III and 1000V CAT II
- CE Approved



2880B



2890A

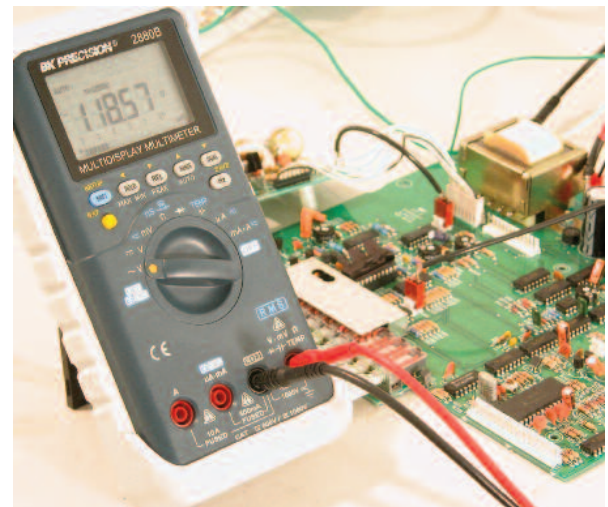

Electronic Circuit Trouble Shooting



Easy to Understand Interface



IEC Rated Inputs



Back Lit LCD (2890A only)



Square Wave Output (2890A only)

Display 51,000 Count Multimeters

New DMM Test kits Contains Most Commonly Requested Accessories

B&K Precision Corporation's new Model 2880BKIT and 2890AKIT DMM Test Kits are the latest additions to its growing line of test and measurement instruments. The new kits combine B+K's most popular DMM's with the most commonly requested accessories for each model. B+K has taken the guesswork out of ordering these meters and accessories. Now, the user can have all of the tools ready upon receipt to take full advantage of either meters capability. The new DMM kits offer versatility and reliability for a broad spectrum of applications, while providing a significant cost savings over individual component pricing. B+K Precision's new DMM kits are the ideal tools to get the job done quickly and economically. These value-packed meter kits are a must for every electronic professional. For more information on these kits see page 72 or go to www.bkprecision.com

2880BKIT



2890AKIT



Specifications

	2880B	2890A
DC Volts		
Ranges	50 mV, 500 mV, 1000mV, 5V, 50V, 500V, 1000V	
Resolution	1 uV, 10 uV, 0.1 mV, 0.1 mV, 1 mV, 10 mV, 0.1V	
Accuracy	+-(0.05% rdg + 50 dgt), +-(0.03% rdg + 5 dgt)	
Overload protection	600VDC/1200V peak	
Input Impedance	10 MΩ (1000 MΩ for 50 mV and 500 mV ranges)	
AC Volts		
Ranges	50 mV, 500 mV, 1000mV, 5V, 50V, 500V, 750V	
Resolution	1 uV, 10 uV, 0.1 mV, 0.1 mV, 1 mV, 10 mV, 0.1V	
Accuracy (Basic AC)	±(0.6% rdg + 25 dgt)	
Frequency Response	30 Hz to 30 kHz	
Overload Protection	1200 VDC or 850 VAC rms (600 VDC or AC to 500 mV range)	
Input Impedance	10 MΩ	
Current		
Ranges	500uA, 5 mA, 50 mA, 500 mA, 5A, 10A	
Resolution	10 nA, 0.1 uA, 1 uA, 10 uA, 0.1 mA, 1 mA	
Accuracy (Basic DC)	±(0.1% rdg + 5 dgt)	
Accuracy (Basic AC)	±(0.8% rdg + 20 dgt)	
Frequency Response	30 Hz to 30 kHz	
Overload Protection	10A continuous	
Resistance/Conductance		
Ranges	500Ω , 5 kΩ, 50 kΩ, 500 kΩ, 5 MΩ, 50 MΩ, 500MΩ(model 2890A), 500nS	
Resolution	0.01Ω , 0.1 Ω, 1 Ω, 10 Ω, 1 kΩ, 1 kΩ, 0.01nS	
Accuracy (Basic)	±(0.8% rdg + 5 dgt)	
Overload Protection	600VDC, AC rms	
Frequency	Does not apply	±0.02% +3dgt
Frequency Counter	Does not apply	±0.002% +5dgt
Square Wave Output	Does not apply	±0.005% +2dgt
Diode Check		
Range	Diode	
Resolution	0.1mV	
Accuracy	±(0.05% rdg + 5 dgt)	
Test Current	Approx. 1.0mA	
Open Voltage	< +4.8V DC	
Overload Protection	1000V RMS for the circuits<0.3A short circuit	
Continuity	Buzzer threshold: sounds below 100 mΩ	
Display	5 digit LCD with 21 segment analog bargraph and automatic polarity indication	
Operating Temperature	32° F to 122° F (0° C to + 50° C), <= 80% RH	
Power	Single 9V battery	
Battery life	80 hrs typ (alkaline)	
Auto power off	Approx. 10 min.	
Dimensions (HxWxD)	7.56x3.55x1.46 (192x90x37 mm)	
Weight (approx)	2 lbs. (936g)	

Accessories

Three Year Warranty

SUPPLIED: Battery, test leads, holster, manual
 OPTIONAL: AK 2880B Communication Package, TL-50 Maxi-Pro DMM Kit, TL 130A General Purpose DMM Kit, TP-A Temperature Adapter, Temperature Probes, Carrying Case (not included); LC 29B
 NOTE: For more detailed specifications, please use specifications in the downloadable instruction manual.

Test Bench® High Performance DMM

Models 388B, 389A, 390A & 391A

High performance and value priced, the Test Bench® Series offers more features for the dollar than other multimeters. These meters include Component Test capabilities, Resistance, Diode Test and Capacitance, in addition to measuring Frequency, Temperature and a Logic Indicator. See the chart below for the meter that best fits your needs. Dual injection molding process allows a better grip and protection for the meters. CE marked and UL listed.

Common Features

- Resistance measurement
- Diode check
- Frequency measurement
- Audible continuity
- All current ranges fused
- Ruggedized case
- Auto power off
- Designed to meet IEC61010-1
CATIII 1000V, class 2



391A

390A

389A

388B

High Quality, Ruggedized, Multifunction

Features

	391A	390A	389A	models 388B
Basic Functions				
True RMS	√			
Ranging	Manual	Auto/Manual	Auto/Manual	Manual
DCV Accuracy	0.05%	0.1%	0.25%	0.5%
AC/DC Voltage and Current	√	√	√	√
Display Digits, Count	4 1/2, 20000	3 3/4, 4000	3 3/4, 4000	3 3/4, 4000
Bar Graph (41 Segment)		√	√	
Capacitance Measurement		√	√	√
Transistor Test				√
Temperature Probe		√		
Logic Probe	√			√
Relative Mode		√	√	
Min/Max Hold		√	√	
Peak Hold		√	√	
Data Hold	√	√	√	
RS-232		√		

Specifications

	391A	390A	389A	models 388B
Volts	True RMS reading			
DC Ranges	200mV, 2V, 20V, 200V, 1,000V	400mV, 4V, 40V, 400V, 1000V		
AC Ranges	200mV, 2V, 20V, 200V, 750V	400mV, 4V, 40V, 400V, 750V		
Resolution	10μV, 100mV, 1 mV, 10mV, 100mV	100μV, 1mV, 10mV, 100mV, 1V		
DC Accuracy	±(0.05% + 3 dgt)	±(0.1% rdg + 2 dgt)	±(0.25% rdg + 2 dgt)	±(0.5% rdg + 1 dgt)
AC Accuracy	±(1% + 10 dgt.) 50Hz-500Hz	400mV: ±(1.2% rdg + 5 dgt)		±(1.2% rdg + 4 dgt)
	±(2% + 10 dgt.) 500Hz - 2kHz,	50Hz-100Hz		750V: ±(2% rdg + 4 dgt)
	500Hz on 750Vrange	±(1.0% rdg + 3 dgt) 50Hz-500Hz	>10% of range at 200mV range	±(1.5% rdg + 3 dgt) 500Hz-1kHz
Overload Protection	1200VDC or AC rms	1100VDC or AC rms		1200VDC or AC rms
	500VDC/AC rms 15 sec			500VDC/AC rms 15 sec
	on 200mV range			on 200mV range
Input Impedance	10MΩ	400mV: >100MΩ, 4V: 10MΩ,	40V - 1000V: 9.1MΩ	10MΩ

New Kits (for more information see page 72)

Model 388BKIT is ideal for general purpose electronic and electrical trouble shooting or repair. Kit contains flexible pincer and alligator clips for larger components and miniature hook clips for smaller ones.

Model 391AKIT is the perfect kit for anyone testing or measuring electronic circuits. Kit includes spring-load tip miniature probes for testing those micro-sized circuits.

Specifications (continued)

	391A	390A	389A	models 388B
Current	True RMS reading			
Ranges	200µA, 2mA, 20mA, 200mA, 20A*	400µA, 4mA, 40mA, 400mA, 20A*		400mA, 4mA, 40mA, 400mA, 2A, 20A*
Resolution	10nA, 100nA, 1µA, 10µA, 1mA	0.1µA, 1µA, 10µA, 100µA, 10mA		100nA, 1µA, 10µA, 100µA, 1mA, 10mA
DC Accuracy	200µA to 200mA: ±(0.5% rdg + 5 dgt.) 20A: ±(2% rdg + 10 dgt.)	400µA - 400mA: ±(1% rdg + 5dgt) 20A: ±(2% rdg + 3 dgt)	±(1% rdg + 1 dgt) ±(2% rdg + 3dgt)	400µA - 400mA: ±(1% rdg + 1 dgt) 2A: ±(1.5% rdg + 1 dgt) 20A: ±(3% rdg + 3 dgt)
AC Accuracy	200µA to 200mA: ±(1.2% rdg + 10 dgt.) 20A: ±(2.5% rdg + 20 dgt.)	400µA to 400mA: ±(1.5% rdg + 4 dgt) 20A: ±(2.5% rdg + 4 dgt.)		400µA - 400mA: ±(1.5% rdg + 1 dgt) 2A: ±(2% rdg + 4 dgt) 20A: ±(3.5% rdg + 4 dgt)
Input Protection	µA/mA input: 0.5A/500V fast blow ceramic fuse 20A input: 20A/600A fast blow ceramic fuse	µA/mA input: 0.5A/500V fast blow ceramic fuse 20A input: 20A/600A fast blow ceramic fuse		µA/mA input: 2A/600V fast blow ceramic fuse 20A input: 20A/600V fast blow ceramic fuse
Max. Burden Voltage	600mV (900mV on 20A range)	500mV (2V on 4mA, 400mA ranges)		600mV (900mV on 2A, 20A ranges)
Resistance				
Ranges	200Ω, 2kΩ, 20kΩ, 200kΩ; 2MΩ, 20MΩ	400Ω, 4kΩ, 40kΩ, 400kΩ, 4MΩ, 40MΩ		
Resolution	10mΩ, 100mΩ, 1Ω, 10Ω, 100Ω, 1kΩ	100mΩ, 1Ω, 10Ω, 100Ω, 1kΩ, 10kΩ		
Accuracy	200Ω, 2MΩ: ±(0.25% rdg + 10 dgt.) 2kΩ to 200kΩ: ±(0.15% rdg + 3 dgt.) 20MΩ: ±(1.0% + 10 dgt.)	400Ω to 400kΩ: ±(0.5% rdg + 4 dgt.) 4MΩ: ±(1% rdg + 5 dgt.) 40MΩ: ±(2% rdg + 5 dgt.)		400Ω: ±(1% rdg + 4 dgt.) 4kΩ to 4MΩ: ±(0.8% rdg + 4 dgt.) 40MΩ: ±(2% rdg + 5 dgt.)
Open Circuit Voltage	3.2VDC typ.	-0.45VDC typ. (-1.2VDC on 400Ω range)		0.6VDC typ. (3.2VDC on 400Ω range)
Overload Protection		500VDC or ACrms		
Diode Test	Tested at 1mA, 3.2VDC max. type. ±(1% rdg + 10 dgt.) accuracy	Tested at 1.2mA, 3.0VDC max. type. ±(1.5% rdg + 3 dgt.) accuracy		Tested at 1mA, 3.2VDC max. type. ±(1.5% rdg + 3 dgt.) accuracy
Transistor Test (hFE)	Does not apply	Does not apply		hFE range: 0 - 1000 hFE base current: 10µADC
Capacitance				
Ranges	Does not apply	4nF, 40nF, 400nF, 4µF, 40µF, 400µF, 4mF, 40mF		4nF, 40nF, 400nF, 4µF, 40µF
Resolution		1pF, 10pF, 100pF, 1nF, 10nF, 100nF, 1µF, 10µF		0.1pF, 1pF, 10pF, 100pF, 1nF
Accuracy		4nF: ±(3% rdg + 20 dgt.) 4nF to 40µF: ±(3% rdg + 5 dgt.) 400µF to 40mF: ±(5% rdg + 10 dgt.)		±(3% rdg + 4 dgt.)
Test Voltage		< 1V		< 3.5V
Overload Protection		500VDC or AC rms		
Frequency				
Ranges	2kHz, 20kHz, 200kHz	4kHz, 40kHz, 400kHz, 4MHz, 40MHz		4kHz, 40kHz, 400kHz, 4MHz
Resolution	0.1 Hz, 1Hz, 10Hz	1Hz, 10Hz, 100Hz, 10kHz, 100kHz		1Hz, 10Hz, 100Hz, 10kHz
Accuracy	±(0.1% rdg + 3 dgt.)	±(0.1% rdg + 3 dgt.)	±(0.25% + 4 Digits)	±(0.1% + 2 Digits)
Sensitivity	50mVrms min. (@ >30 & <70% duty cycle: 400mVrms min.)	1Hz - 4MHz: 1Vrms 4MHz - 40MHz: >2Vrms, <5Vrms		250mVrms min. on 10Hz to 1MHz 500mVrms min. on 1MHz to 4MHz
Minimum Pulse Width	>25ns	>25ns		>2µs
Duty Cycle Limits	>30% & <70%	>30% & <70%		
Minimum Input Range	2kHz: 10Hz: 20kHz: >60dgt; 200kHz: >60dgt			
Overload Protection		500VDC or AC rms		
Logic Test		Does not apply	Does not apply	
Logic Threshold	Hi=2.8±0.8V, 0=0.8 ± 0.5V			Hi=2.8±0.8V, 0=0.8 ± 0.5V
Frequency Response	20MHz			20MHz
Pulse Width	25ns			25ns
Pulse Limits	>20% and <80%			>20% and <80%
Indication	40m sec beep at logic 1 (Hi)			40m sec beep at logic 1 (Hi)
Overload Protection	500V DC or ACrms			500V DC or ACrms
Temperature	Does not apply		Does not apply	Does not apply
Range, Resolution		-58° to +2372°F, 1F° (-50° to +1300°C, 1C°)		
Accuracy		±(0.8% rdg + 2°C) -50° - 400°C ±(1% rdg + 2°C) 400° - 1300°C		
Duty Cycle		Does not apply	Does not apply	Does not apply
Range, Resolution	0 to 90%, 0.1%			
Accuracy (5V logic)	±(2.0% rdg + 10 dgt.)			
Minimum Pulse Width	10µs			
Frequency Range	40Hz to 20kHz			
Overload Protection	500VDC or AC rms			
General				
Display	20000 count, 4 1/2 digit LCD	4000 count, 3 3/4 digit LCD with 41 segment analog bar graph		4000 count, 3 3/4 digit LCD
Polarity	Automatic, positive implied, negative polarity indication			
Operating Temperature	32° to 122° (0° to 50°C), 0 to 70% R.H.			
Dimensions (HxWxD)	7.8 x 3.5 x 1.57" (198 x 90 x 40mm)			
Weight	11.3 oz. (320g).			

Accessories

Three Year Warranty

SUPPLIED: 9 Volt Battery, Test Leads, Instruction Manual, Thermocouple Probe (Model 390A), Software and Interface Cable (Model 390A)
 OPTIONAL: TL 2A Deluxe Test Leads, TL 3 Accessory Tip Kit (for TL 2A), PR 28A High Voltage Probe (40kVDC),
 TL 130A General Purpose DMM Kit, TL-50 Maxi-Pro DMM Kit, Carrying Case (not included): LC 29B

*10 A continuous, 20A for 30 seconds max.

For more product information please visit www.bkprecision.com

59

Tool Kit® Multimeters

Models 2703B, 2704B 2706A, & 2707A

Excellent meters for most jobs that require flexibility, accuracy and speed. Value packed features make these meters a must in every "Tool Kit®."



2703B



2704B

Common Features:

- 2000 count
- 0.5% DCV accuracy
- DC voltage to 1000V
- AC voltage to 750V
- DC current to 10A
- Continuity
- Diode test
- Drop resistant case

Features

	2707A	2706A	2704B	models 2703B
Basic Functions				
Ranging	Manual	Manual	Manual	Manual
Current	10A AC/DC	10A AC/DC	10A AC/DC	10A DC
Component Tests				
Resistance	0.1Ω to 200MΩ	0.1Ω to 20MΩ	0.1Ω to 20MΩ	0.1Ω to 20MΩ
Capacitance	to 20μF	to 20μF	to 20μF	
Transistor Test	√	√	√	
Frequency Counter	√	√	√	
Temperature Probe		√		
Logic Probe	√			

Specifications

	2707A	2706A	2704B	2703B	models
DC Volts					
Ranges	200mV, 2V, 20V, 200V, 1000V				
Resolution	100μV, 1mV, 10mV, 100mV, 1V				
Accuracy	±(0.5% + 1 Digit)				
Overload Protection	200mV Range 500V DC + AC Peak, 350V RMS Sine; All Other Ranges: 1200V DC + AC Peak, 800V RMS, Sine				
Input Impedance	10MΩ				
AC Volts					
Ranges	200mV, 2V, 20V, 200V, 750V			200V, 750V	
Resolution	100μV, 1mV, 10mV, 100mV, 1V			100mV, 1V	
Basic Accuracy	±(0.5% + 1 Digit)				
Frequency Response	50 to 500 Hz				
Overload Protection	200mV Range: 500V DC + AC Peak, 350V RMS, Sine All Other Ranges: 1200V DC + AC Peak, 800V RMS, Sine				
Input Impedance	10MΩ			4.5MΩ	
DC Current					
Ranges	200μA, 2mA, 20mA, 200mA, 2A, 10A (2A: 2706A only)			200mA, 20mA, 200mA, 10A	
Resolution	0.1μA, 1μA, 10μA, 100μA, 1mA, 10mA (1mA: 2706A only)			0.1μA, 1μA, 100μA, 10mA	
Accuracy	±(1% + 1 Digit); 10A Range: ±(2% + 3 Digits)				
Burden Voltage	10A and 200mA range: 750mV max.; All Other Ranges: 325mV max.				
Overload Protection	10A Range: Unfused; All Other Ranges: 250V Fuse				
AC Current					
Ranges	200μA, 2mA, 20mA, 200mA, 2A, 10A (2A: 2706A only)			Does not apply	
Resolution	0.1μA, 1μA, 10μA, 100μA, 1mA, 10mA (1mA: 2706A only)			Does not apply	
Accuracy	±(1.2% + 4 Digits); 10A Range: ±(2% + 4 Digits)			Does not apply	
Frequency Response	50 to 500 Hz			Does not apply	
Burden Voltage	10A and 200mA Range: 750mV max.; All Other Ranges: 325mV max.			Does not apply	
Overload Protection	10A Range: Unfused; All Other Ranges: 0.63A/ 250V Fuse			Does not apply	
Resistance					
Ranges	200Ω, 2kΩ, 20kΩ, 200kΩ, 2MΩ, 20MΩ, 200MΩ (200MΩ: 2707A only)				
Resolution	0.1Ω, 1Ω, 10Ω, 100Ω, 1kΩ, 10kΩ, 100kΩ (100kΩ: 2707A only)				
Basic Accuracy	200MΩ Range (2707A only): ±(5% + 10 Dgt.); ±(0.8% + 1 Digit)				
	20MΩ Range: ±(3% + 1 Digit)		43MΩ Range: ±(1.5% + 4 Digit)		200Ω Range: ±(1% + 3 D)
Overload Protection	500V DC + AC Peak				

Tool Kit® Multimeters



2706A



2707A

Specifications (continued) models

	2707A	2706A	2704B	2703B
Diode Test	Tested at 1.6mA and 3.2V Max.			Does not apply
Transistor Test (hFE)	Base Current: 10µA Vce: 2.8V; Gain Indication: 0 to 1,000			Does not apply
Capacitance				Does not apply
Ranges	2,000pF, 20nF, 200nF, 2µF, 20µF			
Resolution	1pF, 10pF, 100pF, 1nF, 10nF			
Accuracy	±(3% + 10 Digits)			
Test Frequency, Voltage	400Hz, 50mV			
Frequency				Does not apply
Ranges	2kHz, 20kHz, 200kHz, 2MHz, 15MHz			
Resolution	1Hz, 10Hz, 100Hz, 1KHz, 10KHz			
Accuracy	±(0.1% + 2 Digit)			
Sensitivity	1Vrms			
Overload Protection	500V DC + AC Peak			
Logic Probe (TTL)	Does not apply			Does not apply
Logic Threshold	1 = 2.8 ± 0.8V, 0 = 0.8 ± 0.5V			
Minimum Pulse Width	25nS			
Input Impedance	120kΩ nom.			
Overload Protection	500V DC + AC Peak			
Temperature	Does not apply			Does not apply
Range		-4° to + 1400°F (-20° to + 750°C)		
Accuracy	Does not apply		Does not apply	Does not apply
-4° to + 900°F (-20° to 500°C)		±(2% + 4°F) ±(2% + 2°C)		
900° to + 1400°F (500° to + 750°C)		±(3% + 4°F) ±(3% + 2°C)		
Continuity Tone	Tone Sounds within 100mS for Resistance Under 100Ω			
General				
Display	3 1/2 digit, high-contrast 0.7" LCD, 1999 counts			
Sampling	3 times/sec. (nominal)			
Operating Temp:	32° to 104°F (0° to + 40°C), 0 to 70% RH			
Storage Temp	-4° to 140°F (-20° to + 60°C), 0 to 80% RH			
Power Requirements	9 Volt NEDA 1604.			
Battery Life	200 hours (alkaline) nominal 275 hours (alkaline) Nominal (2703B only)			
Dimensions (HxWxD)	5.9 x 3.1 x 1.3" (150 x 79 x 33 mm)			
Weight	9 oz. (250g) with battery			

One Year Warranty

Accessories

SUPPLIED: Battery, Test Leads, Instruction Manual, Thermocouple Probe (2706A only)
 OPTIONAL: TL 2A Deluxe Test Leads, TL 3 Accessory Tip Kit (for TL 2A), PR 28A High Voltage DMM Probe (40kVDC),
 TL 130A General Purpose DMM Kit, Carrying Case (not included): LC 29B

New Kit (for more information see page 72)

Model 2704BKIT - This kit includes a perfect introduction meter and accessories. Basic starter leads for everyday use.

Mini-Pro® Multimeters

Models 2405A, 2407A & 2408

Reliable, Durable & Multi-Function



2405A



2407A



2408

Non-Contact Voltage Indicator.
Light and sound denote the presence of AC voltage from 70V to 480VAC @50 - 60Hz. This eliminates the need for an extra tool to carry in your toolbox.

The Mini-Pro® multimeters are a professional quality multimeter at low cost. Three new meters with a price point that will put them in every toolbox and field service kit. The unique design fits easily in the palm of your hand and CE approval ensures safe operation. Manual and autoranging models offer the basic functionality needed to do 90% of most required testing.

These meters are the best value for any hobbies. No home should be without one!

Common Features:

- DC/AC voltage to 600V
- DC current to 10A
- Resistance to 20MΩ (model 2407A 31MΩ)
- Diode test
- Low battery indicator
- CE approved

Features	2405A	2407A	models 2408
Basic Functions			
Display Counts	2000	3200	2000
Basic DC Accuracy	2.0%	1.2%	1.2%
Ranging	Manual	Auto	Manual
Current	10A DC	10A AC/DC	10A AC/DC
1.5V & 9V Battery Test	√		
Auto Zeroing	√		√
Bar Graph		√	
Auto Power Off		√	
Continuity		√	√
Data Hold		√	√
Max. Hold			√
Non-contact Voltage Indicator			√

For more information about the voltage detector please see our demo video on the Web - www.bkprecision.com

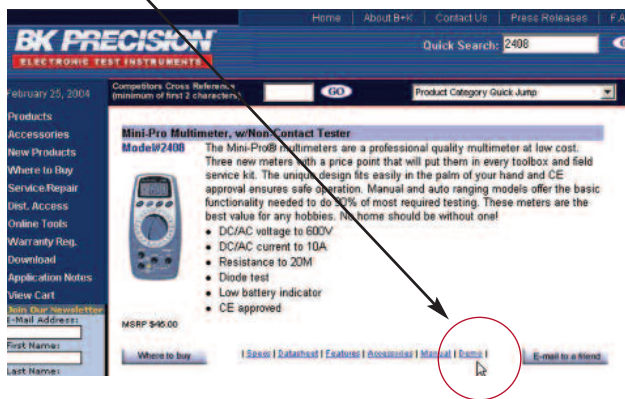

40KV High Voltage Probe Meter

Model HV-44A

The HV-44A is a self-contained instrument that measures high DC voltages up to +40KV. This probe is typically used to measure high voltages in TV sets, power supplies, laboratories and for general high voltage commercial applications.

Specifications

	model HV-44A
Voltage range	0 to +40KV DC
Input Impedance	600MΩ, nominal
Accuracy	±3% of full scale.
Calibration	Internal, factory calibrated at 25KV
Size	16.5 x 2.125 x 2" with a 34" long ground cord (419 x 54 x 50mm with a 86.4cm long ground cord)
Probe Tips	Two interchangeable tips; one round needle type, one special flat spring type for easy access to CRT anode.

One Year Warranty

Mini-Pro® Multimeters

Specifications		models		
		2405A	2408	2407A
DC VOLTS	Manual Ranging		Auto/Manual ranging	
Ranges	2V, 20V, 200V, 600V	200mV, 2V, 20V, 600V	320mV, 3.2V, 32V, 320V, 600V	
Resolutions	1mV, 10mV, 100mV, 1V	100μV, 1mV, 10mV, 1V	100μV, 1mV, 10mV, 100mV, 1V	
Basic Accuracy	±(2%rdg+1dgt)	±(1.2%rdg+1dgt)	±(1.2%rdg+1dgt)	
Overvoltage Protection	600V, DC + AC Peak	600V, DC + AC Peak	600V, DC + AC Peak	
Input Impedance	10MΩ	10MΩ	10MΩ, 1GΩ (320mV range only)	
AC VOLTS	Manual ranging, average responding, rms reading		Auto/Manual ranging, average responding, rms reading	
Ranges	200V, 600V	200mV, 2V, 20V, 600V	3.2V, 32V, 320V, 600V	
Resolutions	100mV, 1V	100μV, 1mV, 10mV, 1V	1mV, 10mV, 100mV, 1V	
Basic Accuracy	±(2.9%rdg+4dgt), 50Hz-500Hz	±(2%rdg+1dgt), 50Hz-500Hz	±(1.5%rdg+4dgt), 50/60Hz	
Input Impedance	10MΩ	10MΩ	10MΩ	
DC CURRENT	Manual ranging		Auto/Manual ranging	
Ranges	200μA, 2mA, 20mA, 200mA, 10A*	2mA, 20mA, 200mA, 10A*	320μA, 3200μA, 32mA, 320mA, 10A*	
Resolutions	0.1μA, 10μA, 100μA, 10mA	0.1μA, 10μA, 100μA, 10mA	0.1μA, 1μA, 10μA, 100μA, 10mA	
Basic Accuracy	±(3.0%rdg+ dgt)	±(1.5%rdg+1dgt), ±(3.0%rdg+1dgt) for 20A	±(2.0%rdg+4dgt), ±3.0%rdg+1dgt) fro 20A	
Overload protection	0.8A, 250V fuse; 10A, 600V fused	0.8A, 250V fuse; 10A, 600V fused	0.5A, 250V fuse; 10A, 600V fused	
*10A on for 30 seconds maximum, off for 3 minutes minimum.				
AC CURRENT	Does not apply	Manual ranging	Auto/Manual ranging	
Ranges		200μA, 20mA, 200mA, 10A	320μA, 3200μA, 32mA, 320mA, 10A*	
Resolutions		0.1μA, 10μA, 100μA, 10mA	0.1μA, 1μA, 10μA, 100μA, 10mA	
Accuracy		±(2.0%rdg+4dgt) for 10A	±(2.5%rdg+4dgt) 50/60Hz	
		±(3.5%rdg+4dgt)	±(3.5%rdg+1dgt) 50.60Hz for 20A	
Overload protection		0.5A, 250V fuse, 10A, 600V		
*10A on for 30 seconds maximum, off for 3 minutes minimum.				
RESISTANCE	Manual ranging		Auto/Manual ranging	
Ranges	200Ω, 2kΩ, 20kΩ, 200kΩ, 20MΩ	200Ω, 20kΩ, 200kΩ, 20MΩ	320Ω, 3.2kΩ, 31kΩ, 310kΩ, 3.1MΩ, 31MΩ	
Resolutions	100mΩ, 1Ω, 10Ω, 100Ω, 1kΩ	100mΩ, 10Ω, 100Ω, 10kΩ	100mΩ, 1Ω, 10Ω, 100Ω, 1kΩ, 10kΩ	
Accuracy	±(2%rdg+3dgt)	±(1.5%rdg+4dgt), ±(3.0%rdg+4dgt) for 20MΩ	±(1.0%rdg+3dgt), ±(1.5%rdg+2dgt) for 3.1MΩ	
		±(5.0%rdg+5dgt) for 31MΩ		
Open circuit voltage	approx. 0.3VDC	approx. 0.3VDC	approx. 1.5VDC	
Overload protection	500V DC + AC Peak	500V DC + AC Peak	500V DC + AC Peak	
DIODE CHECK				
Resolution	1mV	1mV	1mV	
Accuracy	±(3%rdg+3dgt)	±(2.0%rdg+1dgt)	±(10%rdg+3dgt)	
Open Circuit Voltage	3VDC Type.	3VDC Type.	<3.5VDC	
Test Current (approximate)	1.0mA ±0.6mA	1.0mA	1.0mA ±0.6mA	
Overload protection	500V DC + AC Peak	500V DC + AC Peak	500V DC + AC Peak	
Measures forward voltage drop of diode or semiconductor junction in mV.				
CONTINUITY CHECK	Does not apply			
Buzzer Threshold		<100Ω	<320Ω	
Overload protection		500V DC + AC Peak	500V DC + AC Peak	
Battery Test	1.5V, 9V	Does not apply	Does not apply	
Non-Contact Voltage Indicator	Does not apply	Detect voltages from 70V to 480VAC	Does not apply	
		50Hz - 60Hz		
Display	2000 count, 3 1/2 digit 0.53" LCD	2000 count, 3 1/2 digit 0.53" LCD	3200 count, 3 1/2 digit 0.4" LCD	
		with 32 segment analog bargraph		
Polarity	Automatic, (-) negative polarity indication			
Overrange Indication	"OL" or "-OL" is displayed			
Measurement Rate	2.5 samples per second	2.5 samples per second	2 samples per second	
Low Battery Indication	Symbol Displayed			
Operating Temperature	32° to 122°F(0° to + 50°C), <70% R.H			
Storage Temperature	-4° to 140°F(-20° to + 60°C), <70% R.H, battery removed			
Power	Single standard 9V battery, NEDA 1604 or equivalent			
Battery Life	200 hours typical (alkaline)			
Dimensions (HxWxD)	5.63 x 2.25 x 1.375" (143 x 68 x 47mm)			
Weight	7.27 oz. (206g)			

Accessories

One Year Warranty

SUPPLIED: Battery, Test Leads, Instruction Manual

OPTIONAL: TL 2A Deluxe Test Leads, TL 3 Accessory Tip Kit (for TL 2A), TL 130A General Purpose DMM Kit, Carrying Case (not included): LC 24

Non-Contact ACV Detectors with Flashlight

Pocket DMM with Bargraph Model 2700

- Analog bargraph
- 3200 count display
- Auto power off
- Range Hold
- Data Hold



2700

Specifications

model

	2700
DC VOLTS	Auto/Manual ranging
Ranges	300mV, 3V, 30V, 300V, 450V
Resolutions	100µV, 1mV, 10mV, 100mV, 1V
Basic Accuracy	±(1.3%rdg+2dgt)
Overvoltage Protection	500V, DC + AC Peak
Input Impedance	10MΩ
AC VOLTS	Auto/Manual ranging, average responding, rms reading
Ranges	3V, 30V, 300V, 450V
Resolutions	1mV, 10mV, 100mV, 1V
Accuracy	±(2.3%rdg+5dgt)
Input Impedance	10MΩ
RESISTANCE	Auto/Manual ranging
Ranges	300Ω, 3kΩ, 30kΩ, 300kΩ, 3MΩ, 30MΩ
Resolutions	100mΩ, 1Ω, 10Ω, 100Ω, 1kΩ, 10kΩ
Basic Accuracy	±(2.0%rdg+3dgt), ±(6%rdg+3dgt) for 3.1MΩ, 10% for 30MΩ
Open circuit voltage	approx. 1.3VDC
Overload protection	500V DC + AC Peak
CONTINUITY CHECK	
Range	300Ω
Buzzer Threshold	<20Ω
Overload protection	500V DC+AC Peak
Battery Drain	No
Display	3200 count LCD with 32 segment analog bargraph
Polarity	(-) negative polarity indication
Overrange Indication	"OL" displayed
Low Battery Indication	"B" displayed
Operating Temperature	32° to 104°F (0° to 40°C), <70% RH
Storage Temperature	-4° tp +140°F (-20° to +60°C)
Power	Two 1.5V button type batteries NEDA I166A or equivalent
Battery Life	250 hours
Dimensions (HxWxD):	4.4 x 2.2 x 0.4" (112 x 56 x 11 mm)
Weight	3 oz. (86 g) with batteries

Accessories

One Year Warranty

Batteries, Instruction manual, Case



SenseLite



AC Voltage Detector

Detects AC Voltage from 40VAC to 300VAC



Water Resistant



No Lithium Battery

Uses Standard Alkaline AAA Battery

Long Battery Life



100,000hr Bulb

Ultra-Bright White LED

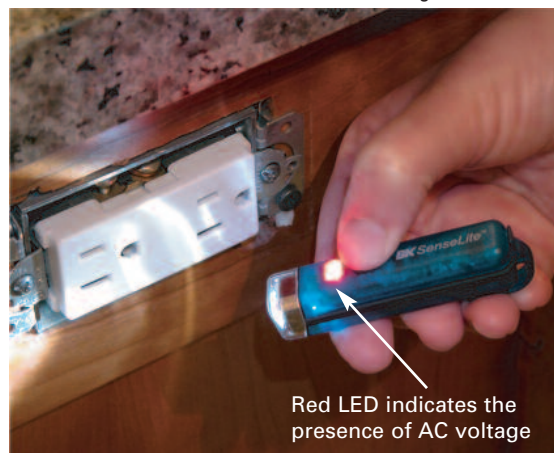

Red LED indicates the presence of AC voltage

SenseLite™

AC Voltage Detector and LED Pocket Flashlight

The SenseLite™ is fully functional, high intensity, battery powered flashlight with a non-contact AC voltage detection circuit and red LED indicator. This compact, lightweight, portable, battery-powered unit is a hand-held and it is used to illuminate the work area when tracing AC circuits in dark areas or behind equipment. The SenseLite™ is a "must-have" addition to every toolbox.

B+K Precision's SenseLite™ high intensity pocket flashlight can be used to detect the presence of AC voltage at a socket, switch or wire. Simply place the flashlight near the area to be tested and press the power button. If there is an AC voltage present, the red LED will shine brightly.

B+K Precision's SenseLite™ offers a number of outstanding features including:

■ **AC Voltage Detection (detects AC voltage from 40VAC to 300VAC)**

■ **Water Resistant**

■ **Long Battery Life**

■ **No Lithium Battery, uses standard Alkaline AAA Battery**

■ **100,000 hr Bulb.**
In addition to detecting the presence of AC voltage, B+K Precision's SenseLite™ is a fully functional, adjustable, high intensity LED flashlight that can be placed on a key chain or in a glove compartment for everyday use. The pure white light produced by SenseLite™ is also ideal for camping, boating, and any activity that requires night vision in true color.

Measuring a compact 0.63" wide x .083" high x 2.8" long (1.6cm x 2.1cm x 7.2cm) and weighing only 0.9oz including battery, the SenseLite™ is powered by a standard alkaline AAA battery

Bench Multimeter

4 1/2 Digit True RMS Model 2831D

The model 2831D provides versatility and reliability for a broad spectrum of laboratory and service applications. Being a true Multimeter it can make diode, frequency and continuity measurements in addition to basic current, voltage and resistance measurements.

- True RMS for accurate interpretation of any waveform signal
- 4 1/2 Digit LED display for clear reading in darkest environment
- Great overload protection on all ranges
- Voltage measurements up to 1200VDC and 1000VAC
- Current measurements up to 20A AC/DC
- Basic accuracy for DCV is 0.05%

Extremely versatile, B+K Precision's new Model 2831D True RMS Bench Multimeter features an easy-to-read, front-panel-mounted 4 1/2 digit LED display. The AC/DC voltage range is 2V, 20V, 200V and 1200VDC/1000VAC, with a best resolution of 1uV. The 2831D can measure up to 12A maximum of AC and DC current, and measures frequencies to 1MHz.



Specifications		model
		2831D
DC Volts		
Ranges		200mV, 2V, 20V, 200V, 1200V
Resolution		0.1mV, 1mV, 10mV, 100mV, 1V
Basic Accuracy		0.05% + 5 digit
Input Impedance		10MΩ
AC Volts		
Ranges		200mV, 2V, 20V, 200V, 750V
Resolution		same as DCV
Basic Accuracy		0.75% + 4 digits
Input Impedance		10 MΩ < 100pF
True RMS		Yes
DC Current		
Ranges		2mA, 20mA, 200mA, 2000mA, 20A
Resolution		100nA, 1μA, 10μA, 100μA, 1mA, 10mA
Basic Accuracy		0.75% + 5 digit
Overload Protection		2A/250V fuse & 20A unfused
AC Current		
Ranges		2mA, 20mA, 200mA, 2000mA, 20A
Resolution		100nA, 1μA, 10μA, 100μA, 1mA, 10mA
Basic Accuracy		1.5% rdg + 10 digits
Overload Protection		Same as DC
Resistance		
Ranges		4200Ω, 2kΩ, 20kΩ, 200kΩ, 2000kΩ, 20MΩ
Resolution		00.1Ω, 1Ω, 10Ω, 100Ω, 1kΩ, 10kΩ
Basic accuracy		0.2% rdg + 6 digit
Frequency		
Range		20KHz & 200KHz
Accuracy		± 1.5% + 5 digit, ± 2.0% + 5digit
Sensitivity		4Vp-p
Diode Test		1mA test current
Continuity Check		Audio tone for resistance under <200Ω
General		
Display		4-1/2 digit LCD, 0.5 inch LED
Power		120/240 VAC, 50/60 Hz (5W)
Operating Temperature		32° to 104°F (0° to 40°C), 70% RH
Size (HxWxD)		3.5 x 9.4 x 10.6" (90 x 240 x 270mm)
Weight		4.6 lbs (2.1 kg)

Accessories

One Year Warranty

SUPPLIED: Instruction Manual, Test Leads, AC Power Cord
 OPTIONAL: TL 1 Replacement Test Leads, TL 2A Deluxe Test Leads, TL 3 Accessory Tip Kit (for TL 2A), TL 130A General Purpose DMM Kit, PR 28A High Voltage Probe, CP 3 AC/DC Current Clamp Adapter TL-50 Maxi-Pro DMM Kit

Dual Display Bench Multimeters



5491A

5492

50,000 Count Digit Dual Display Model 5491A

The new PC-Compatible benchtop unit provides an easy to read dual display with 50,000 count accuracy. Model 5491A offers a very accurate, feature packed True RMS bench DMM at a very reasonable price. Because of its low price and high accuracy, Model 5491A is an ideal tool for use in any high school, technical trade school, college and university laboratory, as well as Research & Development, Service, Maintenance, Test and Manufacturing benchtop applications.

- Low cost and high performance
- True RMS (AC, AC + DC)
- Resistance measurements up to 50MΩ
- Measures frequency to 500KHz
- dBm measurement
- RS 232 Interface

5 1/2 Digits Dual Display Model 5492

The Dual Display Multimeter model 5492 is a 5 1/2 digit multimeters with selectable count resolutions up to 120,000 count. It is designed for bench-top, field service, and system applications with a high performance to price ratio.

- Selectable 120,000 / 40,000 / 4,000 Count
- Dual Display
- True RMS (AC, AC+DC), 40Hz to 30KHz Measurement Bandwidth
- 2 or 4 wire selectable for Resistance Measurements
- MIN/MAX
- Selectable measurement rates
- Data Hold
- RS 232 interface
- GPIB version available (model 5492GPIB)

Specifications

	5491A	5492 models
DC Voltage Ranges		
Slow Sampling Rate	N/A	120mV, 1.2V, 12V, 120V, 1000V
Resolution	--	1uV, 10uV, 100uV, 1mV, 10mV
Accuracy ±	N/A	0.02% + 8dgt
Medium Sampling Rate	500mV, 5V, 50V, 500V, 1000V	400mV, 4V, 40V, 400V, 1000V
Resolution	10uV, 100uV, 1mV, 10mV, 100mV	10uV, 100uV, 1mV, 10mV, 10mV, 100mV
Accuracy ±	0.02% + 4dgt	0.02% + 5dgt
Fast Sampling Rate	--	400mV, 4V, 40V, 400V, 1000V
Resolution	--	100uV, 1mV, 10mV, 100mV, 1V
Accuracy ±	--	0.02% + 2dgt
AC Voltage (True RMS, AC Coupling Mode)		
Slow Sampling Rate	N/A	120mV, 1.2V, 12V, 120V, 750V
Resolution		1uV, 10uV, 100uV, 1mV, 10mV
Accuracy ±		1% + 100dgt (20 - 45Hz)
		0.2% + 100dgt (45 - 10kHz)
		1.5% + 300dgt (10k - 30kHz)
		5% + 300dgt (30k - 100kHz)
Medium Sampling Rate	500mV, 5V, 50V, 500V, 750V	400mV, 4V, 40V, 400V, 750V
Resolution	10uV, 100uV, 1mV, 10mV, 100mV	10uV, 100uV, 1mV, 10mV, 100mV
Accuracy ±	1% + 40dgt (30 - 50Hz)	1% + 40dgt (20 - 45Hz)
	0.5% + 40dgt (50 - 10kHz)	0.2% + 40dgt (45 - 10kHz)
	2% + 120dgt (10k - 30kHz)	1.5% + 80dgt (10k - 30kHz)
	3% + 120dgt (30k - 100kHz)	5% + 120dgt (30k - 100kHz)
Fast Sampling Rate	N/A	400mV, 4V, 40V, 400V, 750V
Resolution		100uV, 1mV, 10mV, 100mV, 1V
Accuracy ±		1% + 5dgt (20 - 45Hz)
		0.2% + 5dgt (45 - 10kHz)
		1.5% + 10dgt (10k - 30kHz)
		5% + 15dgt (30k - 100kHz)
AC Voltage (True RMS, AC+DC Coupling Mode)		
Slow Sampling Rate	N/A	120mV, 1.2V, 12V, 120V, 750V
Resolution		1uV, 10uV, 100uV, 1mV, 10mV
Accuracy ±		0.2% + 100dgt (45 - 10kHz)
		1.5% + 300dgt (10k - 30kHz)
		5% + 300Dgt (30k - 100kHz)
Medium Sampling Rate	500mV, 5V, 50V, 500V, 750V	400mV, 4V, 40V, 400V, 750V
Resolution	10uV, 100uV, 1mV, 10mV, 100mV	10uV, 100uV, 1mV, 10mV, 100mV
Accuracy ±	0.5% + 50dgt (50 - 10kHz)	0.2% + 45dgt (45 - 10kHz)
	2% + 70dgt (10k - 30kHz)	1.5% + 300dgt (10k - 30kHz)
	3% + 130dgt (30k - 100kHz)	5% + 300Dgt (30k - 100kHz)
Fast Sampling Rate	N/A	400mV, 4V, 40V, 400V, 750V
Resolution		100uV, 1mV, 10mV, 100mV, 1V
Accuracy ±		0.2% + 7dgt (45 - 10kHz)
		1.5% + 12dgt (10k - 30kHz)
		5% + 18dgt (30k - 100kHz)
DC Current		
Slow Sampling Rate	N/A	12mA, 120mA, 1200mA, 12A
Resolution		0.1uA, 1uA, 10uA, 100uA
Accuracy ±		0.05% + 15dgt
Medium Sampling Rate	500uA, 5mA, 50mA, 500mA, 5A, 10A	40mA, 120mA, 1200mA, 12A
Resolution	10nA, 100nA, 1uA, 10uA, 100uA, 1mA	1uA, 10uA, 100uA, 1mA
Accuracy ±	0.05% + 5dgt	0.1% + 6dgt
Fast Sampling Rate	N/A	40mA, 120mA, 1200mA, 12A
Resolution		10uA, 100uA, 1mA, 10mA
Accuracy ±		0.1% + 2dgt

Dual Display Bench Multimeters

Specifications (Continued)		models	
	5491A	5492	
AC Current (True RMS, AC Coupling Mode)			
Slow Sampling Rate		12mA, 120mA, 1200mA, 12A	
Resolution		0.1uA, 1uA, 10uA, 100uA	
Accuracy ±		1.5% + 100dgt (20 - 50Hz) 0.5% + 100dgt (45 - 2kHz) 2% + 200dgt (2k - 10kHz)	
Medium Sampling Rate	500uA, 5mA, 50mA, 500mA	40mA, 120mA, 1200mA, 12A	
Resolution	10nA, 100nA, 1uA, 10uA,	1uA, 10uA, 100uA, 1mA	
Accuracy ±	1.5% + 50dgt (30 - 50Hz) 0.5% + 20dgt (50 - 2kHz) 1.5% + 50dgt (2k - 5kHz) 3% + 75dgt (5K - 20KHz)	1.5% + 40dgt (20 - 45Hz) 0.5% + 40dgt (45 - 2kHz) 2% + 80dgt (2k - 10kHz) N/A	
Fast Sampling Rate		40mA, 120mA, 1200mA, 12A	
Resolution		10uA, 100uA, 1mA, 10mA	
Accuracy ±		1.5% + 5dgt (20 - 40Hz) 0.5% + 5dgt (45 - 2kHz) 2% + 10dgt (2k - 10kHz)	
Ac Current (True RMS, AC+DC Coupling Mode)			
Slow Sampling Rate		12mA, 120mA, 1200mA, 12A	
Resolution		0.1uA, 1uA, 10uA, 100uA	
Accuracy ±		0.5% + 100dgt (45 - 2kHz) 2% + 200dgt (45 - 2kHz)	
Medium Sampling Rate	500uA, 5mA, 50mA, 500mA	40mA, 120mA, 1200mA, 12A	
Resolution	10nA, 100nA, 1uA, 10uA	1uA, 10uA, 100uA, 1mA	
Accuracy ±	0.5% + 30dgt (50 - 2kHz) 1.5% + 60dgt (2k - 5kHz) 3% + 85dgt (5K - 20KHz)	0.5% + 42dgt (45 - 2kHz) 2% + 80 (2k - 10kHz) N/A	
Fast Sampling Rate	N/A	40mA, 120mA, 1200mA, 12A	
Resolution		10uA, 100uA, 1mA, 10mA	
Accuracy		0.5% + 7dgt (45 - 2kHz) 2% + 12dgt (2k - 10kHz)	
Resistance (2-wireΩ and 4-wireΩ)			
Slow Sampling Rate	N/A	(1.2k, 12k, 120k, 1.2M, 12M, 120M)Ω	
Resolution		1mΩ, 10mΩ, 100mΩ, 1Ω, 10Ω, 100Ω, 1kΩ	
Accuracy ±		0.1% + 8dgt (2-wire) 0.05% + 8dgt (4-wire)	
Medium Sampling Rate	500Ω, 5KΩ, 50KΩ, 500KΩ, 5MΩ, 50MΩ	(400, 4k, 40k, 400k, 4M, 40M, 300M)Ω	
Resolution	10mΩ, 100mΩ, 1Ω, 10Ω, 100Ω, 1kΩ	10mΩ, 100mΩ, 1Ω, 10Ω, 100Ω, 1kΩ, 10kΩ	
Accuracy ±	0.1% + 5 (500Ω range) 0.1% + 3 (other range)	0.1% + 2dgt (2-wire) 0.05% + 5dgt (4-wire)	
Fast Sampling Rate	N/A	(400, 4k, 40k, 400k, 4M, 40M, 300M)Ω	
Resolution		100mΩ, 1Ω, 10Ω, 100Ω, 1kΩ, 10kΩ, 100kΩ	
Accuracy ±		0.1% + 2dgt (2-wire) 0.05% + 2dgt (4-wire)	
General Specifications			
Warm Up time	At least 30 minutes		
Temperature Coefficient	Add 0.15 x (the applicable Accuracy ±)/°C to 18°C and 28°C to 50°C		
Operating Temperature	0°C to 50°C (32°F to 122°F)		
Storage Temperature	-20°C to 60°C (-4°F to 140°F)		
Line Voltage	100V, 120V, 220V, 240V AC ±-10%, 50/60Hz, 16VA maximum		
Interface	RS-232		
Dimensions (HxWxD)	4.13" x 10" x 12" (105 x 255 x 305)mm		
Weight	6.6 lbs. (3.0 kgs)		
Accessories		One Year Warranty	
SUPPLIED: Instruction Manual & Test Leads			
OPTIONAL: TL 2A, TL 3, TL 130A GP DMM Kit, TL-50 Maxi-Pro DMM kit, AK 5491 Software and RS-232 Cable, KC 01 4 Wire Test Leads with Kelvin Clips, RK 01 Rack Mount, TH 02 Insulation Piercing Clips.			

Specifications (Continued)		models	
	5491A	5492	
DIODE TEST/CONTINUITY			
Slow Sampling Rate			
Maximum Reading	--	1.19999V	
Resolution	N/A	10uV	
Medium Sampling Rate	--	--	
Maximum Reading	2.3000V	2.4999V	
Resolution	100uV	100uV	
Fast Sampling Rate	N/A		
Maximum Reading	--	2.499V	
Resolution	--	1mV	
Resistance/Continuity			
Slow Sampling Rate	N/A	120Ω	
Resolution	--	1mΩ	
Accuracy ±	--	0.1% + 8dgt	
Medium Sampling Rate	500Ω, 5KΩ, 50KΩ, 500KΩ 5MΩ, 50MΩ	400Ω	
Resolution	10mΩ, 100mΩ 1Ω, 10Ω 100Ω, 1KΩ	10mΩ	
Accuracy ±		0.1% + 5dgt	
Fast Sampling Rate		400Ω	
Resolution		100mΩ	
Accuracy ±		0.1% + 2dgt	
Frequency			
Range (Hz)	500, 5k, 50K, 500k	1200, 12k, 120k, 1M	
Resolution (Hz)	0.01, 0.1, 1, 10	10m, 100m, 1, 10	
Accuracy ± (Hz)	0.01% + 5dgt at 500Hz range	0.005% + 3dgt	

5 1/2 Digits Dual Display Model 5492GPIB

The Dual Display Multimeter model 5492GPIB has the same specifications as model 5492 with addition of GPIB interface.

Clamp-On Multimeters

Models 330B, 350B 367A, 369B

B+K Precision offers a wide variety of current clamps for safe non-invasive current measurement. Measure up to 2000A with these reliable, rugged instruments. All of B+K Precision clamps are much more than a current clamp offering the ability to measure, voltage resistance, capacitance and even frequency. Additionally, special features allow for the recording of minimum and maximum values, peak values, test diodes and for continuity. Any one of these products can be a total measurement solution.

- Measures up to 2000A
- Measures up to 1000V
- Jaw openings 2.24" (Models 330B, 350B 369B)
- Low battery indication
- Accessories Supplied: Battery, Test Leads, Instruction Manual, Carrying Case



369B
True RMS



367A



350B



330B

Features

	369B	367A	350B	models 330B
AC Current	1000A	2000A	1000A	1000A
DC Current	1000A	2000A		
AC Voltage	750V	750V	750V	750V
DC Voltage	1000V	1000V	1000V	1000V
Resistance	40MΩ	40MΩ	30MΩ	2000MΩ
Frequency	√	√	√	--
Capacitance	√	√	--	--
True RMS	√	√	--	--
Continuity	√	√	√	√
Diode	√	√	√	√
Count Resolution	4000	4000	3200	2000
Bargraph	√	√	√	--
Data Hold	√	√	√	√
Peak Hold	√	√	√	
Max Hold	--	--	--	√
Range Hold	√	√	√	--
Max/Min	√	√	--	--
Relative	√	√	--	--
Auto Off	30 min.	30 min.	10 min.	--

Specifications

	369B	367A	350B	models 330B
AC Current (using Clamp)				
Ranges	400A, 1000A	400A, 2000A	32A, 320A, 1000A	200A, 1000A
Resolution	100mA, 1A	100mA, 1A	10mA, 100mA, 1A	100mA, 1A
Accuracy (50-60 Hz)	±(1.5% rdg + 5D)	±(1.5% rdg + 5D)	±(1.5% rdg + 5D)	±(1.5% rdg + 5D)
Overload Protection	1200A	1200A	1200A	1200A
DC Current (using Clamp)			Does not apply	Does not apply
Range	400A, 1000A	400A, 2000A		
Resolution	100mA, 1A	100mA, 1A		
Accuracy	±(1.5% rdg + 5D)	±(1.5% rdg + 5D)		
Overload Protection	1200A	1200A		

Clamp-On Multimeters

Specifications		models			
	369B	367A	350B	330B	
AC Voltage (using test leads)					
Range	400mV, 4V, 40V, 400V, 750V	400mV, 4V, 40V, 400V, 750V	320mV, 3.2V, 32V, 320V, 750V	750V	
Resolution	100 μ V, 1mV, 10mV, 100mV, 1V	100 μ V, 1mV, 10mV, 100mV, 1V	100 μ V, 1mV, 10mV, 100mV, 1V	1V	
Basic Accuracy	$\pm(1.5\% \text{ rdg} + 4D)$	$\pm(1.5\% \text{ rdg} + 4D)$	$\pm(1.5\% \text{ rdg} + 4D)$	$\pm(1.2\% \text{ rdg} + 5D)$	
Overload Protection	1000V DC/750V RMS	1000V DC/750V RMS	1000V DC/750V RMS	1000V DC/750V RMS	
Input Impedance	10 M Ω	10 M Ω	10 M Ω	4.5 M Ω	
DC Voltage (using test leads)					
Range	400mV, 4V, 40V, 400V, 1000V	400mV, 4V, 40V, 400V, 1000V	320mV, 3.2V, 32V, 320V, 1000V	1000V	
Resolution	100 μ V, 1mV, 10mV, 100mV, 1V	100 μ V, 1mV, 10mV, 100mV, 1V	100 μ V, 1mV, 10mV, 100mV, 1V	1V	
Basic Accuracy	$\pm(0.5\% \text{ rdg} + 1D)$	$\pm(0.5\% \text{ rdg} + 1D)$	$\pm(0.5\% \text{ rdg} + 1D)$	$\pm(0.5\% \text{ rdg} + 1D)$	
Overload Protection	1000V DC/750V RMS	1000V DC/750V RMS	1000V DC/750V RMS	1000V DC/750V RMS	
Input Impedance	10 M Ω	10 M Ω	10 M Ω	10M Ω	
Resistance					
Range	400 Ω , 4k Ω , 40k Ω , 400k, 4M 40M Ω	400 Ω , 4k Ω , 40k Ω , 400k, 4M 40M Ω	320 Ω , 3.2k Ω , 32k Ω , 320k Ω , 3.2M Ω , 30M Ω	200 Ω , 20k Ω , 20M Ω , 2000M Ω	
Resolution	0.1 Ω , 1 Ω , 10 Ω , 100 Ω , 1k Ω , 10k Ω	0.1 Ω , 1 Ω , 10 Ω , 100 Ω , 1k Ω , 10k Ω	0.1 Ω , 1 Ω , 10 Ω , 100 Ω , 1k Ω , 10k Ω	0.1 Ω , 10 Ω , 10k Ω , 100k Ω	
Basic Accuracy	$\pm(1\% \text{ rdg} + 2D)$	$\pm(1\% \text{ rdg} + 2D)$	$\pm(1\% \text{ rdg} + 3D)$	$\pm(1\% \text{ rdg} + 3D)$ 4k Ω -4M Ω : $\pm(1\% \text{ rdg} + 3D)$ 40M Ω : $\pm(3\% \text{ rdg} + 3D)$	
Overload Protection	500V DC/ AC RMS	500V DC/ AC RMS	500V DC/AC RMS	500V DC/AC RMS	
Frequency					
Range	100Hz, 1kHz, 10kHz, 100kHz, 400kHz	100Hz, 1kHz, 10kHz, 100kHz, 400kHz	320Hz, 3.2kHz, 32kHz		
Resolution	0.01Hz, 0.1Hz, 1Hz, 10Hz, 100Hz	0.01Hz, 0.1Hz, 1Hz, 10Hz, 100Hz	0.1Hz, 1Hz, 10Hz		
Accuracy	$\pm(0.5\% \text{ rdg} + 3D)$	$\pm(0.5\% \text{ rdg} + 3D)$	$\pm(1\% \text{ rdg} + 2D)$		
Overload Protection	500V DC/AC RMS	500V DC/AC RMS	500V DC/AC RMS		
Capacitance					
Range	4nF, 40nF, 400nF, 4 μ F, 40 μ F	4nF, 40nF, 400nF, 4 μ F, 40 μ F			
Resolution	1pF, 10pF, 100pF, 1nF, 10nF, 100nF	1pF, 10pF, 100pF, 1nF, 10nF, 100nF			
Accuracy	$\pm(1.5\% \text{ rdg} + 4D)$	$\pm(1.5\% \text{ rdg} + 4D)$			
Overload Protection	500V DC/AC RMS	500V DC/AC RMS			
Jaw Opening					
	2.24" (57mm)	2.24" (57mm)	2.24" (57mm)	2.24" (57mm)	
Display					
	3 3/4 digit LCD, 4000 count, 9999 in Frequency, 42 segment bar graph	3 3/4 digit LCD, 4000 count, 9999 in Frequency, 42 segment bar graph	3 1/2 digit LCD, 3200 count	3 3/4 digit LCD, 2000 count, 34 segment bar graph	
Polarity					
	Automatic, "-" indicated	Automatic, "-" indicated			
Measure Rate					
	2/sec.	2/sec.	2/sec.	2.5/sec.	
Overrange Indication					
	"OL"	"OL"	"OL"	"OL"	
Operating Temperature					
	32° - 122°F, 70% RH (0° - 50°C)	32° - 122°F, 70% RH (0° - 50°C)	32° - 122°F, 70% R.H. (0° - 50°C)	32° - 122°F, 70% RH (0° - 50°C)	
Storage Temperature					
	-4° - +140°F, 80% RH (-20° - +60°C)	-4° - +140°F, 80% RH (-20° - +60°C)	-4° - +140°F, 80% RH (-20° - +60°C)	-4° - +140°F, 80% RH (-20° - +60°C)	
Power Requirements					
		One 9V battery, alkaline recommended type NEDA 1604A			
Battery Life					
	500 Hours	500 Hours	500 Hours	500 Hours	
Dimensions					
	10.8 x 3.6 x 1.7" (275 x 90 x 43mm)	10.8 x 3.6 x 1.7" (275 x 90 x 43mm)	10.8 x 3.6 x 1.7" (275 x 90 x 43mm)	10.8 x 3.6 x 1.7" (275 x 90 x 43mm)	
Weight					
	18.3oz (519g)	18.3oz (519g)	17oz. (482g)	17oz. (482g)	

Accessories

One Year Warranty

SUPPLIED: Battery, Test leads, Instruction Manual, Carrying Case

OPTIONAL: TL 1 Replacement Test Leads , TL 2A Deluxe Test Leads, TL 3 Accessory Tip Kit (for TL 2A), TL 130A General Purpose DMM Kit, PR 28A High Voltage Probe, LC 33 Carrying Case

Clamp-On Multimeters

True RMS AC/DC Power Clamp Meter

Model 325

The lightweight, portable, battery-powered Clamp-On meter measures the most common AC Volts, DC Volts, and AC current needed to troubleshoot residential and small commercial electrical systems.

- Back light 3 3/4 digits LCD with max. reading 3999, plus decimal point, unit symbol indication
- Auto range, Auto power off, Auto zero
- High speed bargraph
- Function keys: Max./Min. Hold, Data Hold, Trms Positive and Negative Peak Hold
- Test Ranges: ACV, ACA, DCV, DCA, Ω, WATT, Frequency, Continuity
- Jaw openings 1.37" (35mm)



312B

313A

316



325

Mini AC Clamp Meter Models 312B, 313A

- Overload Protection
- Low battery indicator
- 0.98" clamp opening size
- Continuity test
- 2 times/sec sample rate

Features

	313A	312B	models 316
AC Current	600A	200/600A	100A
DC Current	600A		100A
AC Voltage	600V	200/600V	600V
DC Voltage	600V		600V
Resistance	1KΩ	200Ω	10KΩ
Continuity	√	√	√
Data Hold	√	√	√

Milli-Amp AC/DC Clamp Meter

Model 316

B+K Precision offers a wide variety of current clamp meters for safe non-invasive current measurement. The new milli-amp clamp meters are practical where a traditional sized meter may be too cumbersome to use. Model 316 features autoranging capabilities and is ideal for use in cramped quarters. The B+K Precision milli-amp clamp meter is more than just current clamps, it offers the ability to measure voltage and resistance. It also has the added functions of Peak Hold, Data Hold, and has a 4 digit display, these are invaluable tools when evaluating or repairing electronic equipment.

- 4 digit display
- Auto power off
- Low battery indicator
- Overload protection

Specifications	models		
	312B	313A	316
ACA (Autoranging)			
Range	200A, 600A	600A	10A, 80A, 100A
Resolution	0.1A, 1A	0.1A	1mA, 10mA, 10mA
Accuracy			
(50 - 60Hz)	2% + 5	2% + 10	
(50-500Hz)			3.5% + 10
DCA (Autoranging)			
Range	N/A	600A	10A, 80A, 100A
Resolution	N/A	0.1A	1mA, 10mA, 10mA
Accuracy	N/A	2.5% + 10	2.5% + 10
			4.5% + 10
ACV (Autoranging)			
Range	200V, 600V	600V	600V
Resolution	0.1V, 1V	0.1V	0.1V
Accuracy			
(50 - 500Hz)	1.5% + 5	1.5% + 5	1.5% + 5
DCV (Autoranging)			
Range	N/A	600V	600V
Resolution	N/A	0.1V	0.1V
Accuracy	N/A	1% + 2	1% + 2
Resistance			
Range	200ohm	1000ohm	10kohm
Resolution	0.1ohm	0.1ohm	1ohm
Accuracy	1.9% + 3	1% + 3	1% + 3
Accessories			
SUPPLIED: Instruction Manual, Batteries, Test Leads			
OPTIONAL: TL 2A			

One Year Warranty

Specifications	model
	325
DC Current	
Range	400A, 600A
Resolution	0.1A, 1A
Accuracy	1.5% + 5 dgt 2% + 5 dgt
AC Current (True RMS : From 10% to 100% of Range)	
Range	400A, 600A
Resolution	0.1A, 1A
Accuracy	
40 - 65Hz	2.0% + 5 dgt 2.0% + 5 dgt
65 - 1kHz	3.0% + 8 dgt 3.0% + 8 dgt
DC Voltage	
Range	400V, 600V
Resolution	0.1V, 1V
Accuracy	1.0% + 3 dgt
AC Voltage (True RMS : From 10% to 100% of Range)	
Range	400V, 600V
Resolution	0.1V, 1V
Accuracy	
40 - 400Hz	1.2% + 5 dgt
400 - 2kHz	2.0% + 5 dgt
AC + DC WATT	
Range	40KW, 400KW
Resolution	0.01KW, 0.1KW
Accuracy	5.0% + 5 dgt
Resistance	
Range	4000ohm
Resolution	1ohm
Accuracy	1.0% + 3 dgt
Frequency	
Range	4kHz, 40kHz, 400kHz
Resolution	1Hz, 10Hz, 100Hz
Accuracy	0.5% + 3 dgt

Specifications

	models	
	114B	117B
DC VOLTS		
Ranges	0-300mV, 3V, 12V, 30V, 120V, 300V, 1200V	0-10V, 50V, 250V, 500V
Accuracy	±(3%rdg), full scale	±(5%rdg), full scale
Sensitivity	20000Ω/V	2000Ω/V
AC VOLTS		
Ranges	0-6V, 30V, 120V, 300V, 1200V	0-10V, 50V, 250V, 500V
Sensitivity	8000Ω/V	2000Ω/V
Accuracy	±(4%rdg), full scale @50/60Hz	±(5%rdg), full scale
Frequency response	(+ 1dB): 6 V range: 40 Hz to 100 kHz. 30 V range: 40 Hz to 50 kHz. 120 V range: 40 Hz to 10 kHz. 300 V range: 40 Hz to 5 kHz. 1200 V range: 40 Hz to 1 kHz.	
DC CURRENT		
Ranges	0.6μA, 3mA, 30mA, 300mA, 12A	0-0.5mA, 50mA, 250mA
Accuracy	±(3%rdg), full scale	±(4%rdg), full scale
Burden Voltage	Less than 500mV	
RESISTANCE		
Ranges	R X 10, 0 to 20 kΩ, mid scale 200Ω R X 1k, 0 to 2 MΩ, mid scale 20 kΩ R X 10k, 0 to 20 MΩ, mid scale 200 kΩ	0-10kΩ/1MΩ
Resolutions		
Maximum Open Circuit Voltage	R X 1, X 10, X 1k ranges: 3V, R X 10k range: 12 V	
Maximum Short Circuit Current	R X 1 range: 150 mA R X 10 range: 15 mA, R X 1k range: 200 μA, R X 10K range: 100 μA	
Accuracy	±3% of scale arc	±5% arc of scale length
Open circuit voltage	approx. 0.3VDC	approx. 0.3VDC
Overload protection	500V DC + AC Peak	500V DC + AC Peak
dB Measurement	(dB scale)	
Range	-10 dB to +17 dB on 6 V AC range +4 dB to +31 dB on 30 V AC range +16 dB to 43 dB on 120 V AC range +24 dB to 51 dB on 300 V AC range +36 dB on +63 dB on 1200 V AC range	4 dB to +56 dB on ACV range
0 dB Reference	1 mW across 600Ω	1 mW across 600Ω
Battery Test	good-bad scale	good-bad scale
Range	1.5 V range for battery test only	1.5V and 9V
Load	7.5 ohms	
Battery Drain	200 mA	1.5V: 100mA, 9V:20mA
TRANSISTOR LEAKAGE TEST		
Ranges	0 to 150 μA on RX 1k range 0 to 15 mA on RX 10 range, 0 to 150 mA on RX 1 range	
Accuracy	±5% of scale arc	
Maximum Applied Voltage	3 V, voltage measured on LV scale	
TRANSISTOR GAIN MEASUREMENT		
Range	0 to 1,000 measured on hFE scale with range switch set to R X 10	
Accuracy	+3% of scale arc	
Display	Jeweled pivots movement, 60 μA full scale	3 color mirror scale, 180μA
Polarity	+ or -, polarity reversal switch	
Operating Temperature	32° to 104°F (0 to 40°C)	
Storage Temperature	-4° to 140°F (-20° to + 60°C), <70% R.H, battery removed	
Power	Batteries: One 9 V	Two 1.5 V AA
Battery Life	200 hours typical (alkaline)	
Dimensions (HxWxD)	5.79 x 3.9 x 1.38" (147 x 99 x 35 mm)	3.5 x 2.38 x 1.19" (89 x 60 x 30mm)
Weight	11 oz. (308 g) with batteries	11 oz.(300 g)

Accessories

One Year Warranty

SUPPLIED: Batteries, Test leads, 1 red and 1 black, Instruction manual (Model 114B)
1.5V AA Batteries, Test leads, Instruction manual (Model 117B)

Analog Multimeters

Some applications still require a good old analog meter for instant measurement.



**Pocket-Sized
Multimeter
Model 117B**

- Compact size
- Measures DC voltage
- Measures AC voltage
- Measures DC current
- Measures resistance
- Measures decibels
- 9V & 1.5V battery test



**20,000 Ohms/Volt
Multimeter
Model 114B**

- 20,000 ohms/volt DC
- 28 ranges
- 3 1/2" mirrored scale
- Tests batteries under load
- Tests transistors
- Includes batteries and test leads

Multimeter Accessory Kits

True RMS DMM with Test Lead Set

Model 2880BKIT

This kit contains the B&K Precision model 2880B Digital Multimeter and a selected assortment of test lead accessories.

Included Test Lead Accessories

- Highly flexible silicone test leads with sheathed (shrouded) 4mm banana plugs; Right-angle for the meter, straight for the accessories, 1.5m long. Rated IEC 61010-031 1000V CAT III / 600V CAT IV to 12A
- Smooth 2mm tip probe bodies, ideal for everyday testing. Ruggedly constructed, they are rated to IEC 61010-031 1000V CAT III / 600V CAT IV to 36A.
- Flexible pincer clips for long reaches. Pincer tips can grip contact points –up to 0.16" diameter in either electronic or electrical applications. Rated IEC 61010-031 1000V CAT III / 600V CAT IV to 6A
- General purpose probe leads with flexible PVC jacketed wire, 2mm smooth probe tips and right angle sheathed banana plugs. Rated to IEC 61010-031 1000V CAT III / 600V CAT IV to 10A.
- 14" rugged clear plastic carrying case with foam inserts. Holds both meter and accessories



388B DMM with Test Lead set Model 388BKIT

This kit is ideal for general purpose electronic and electrical trouble shooting or repair. Kit contains flexible pincer and alligator clips for larger components and miniature hook clips for smaller ones.

Included Test Lead Accessories:

- 1.5 Meter Long Silicone 4mm Sheathed Straight to Right-Angle Plug Lead Set
- Flexible Pincer Set – Red & Black
- Alligator Clip Set – Red & Black
- Probe Body Set With 2mm (.080") Diameter Tips
- Hook Test Clip to 4mm Banana Jack
- Tri-Fold Nylon Pouch



True RMS Deluxe DMM with Test Lead Set

Model 2890AKIT

This kit contains the B&K Precision model 2890A Digital Multimeter and a selected assortment of test lead accessories.

Included Test Lead Accessories

- Highly flexible silicone test leads with sheathed (shrouded) 4mm banana plugs; Right-angle for the meter, straight for the accessories, 1.5m long. Rated IEC 61010-031 1000V CAT III / 600V CAT IV to 12A
- Smooth 2mm tip probe bodies, ideal for everyday testing. Ruggedly constructed, they are rated to IEC 61010-031 1000V CAT III / 600V CAT IV to 36A.
- Flexible pincer clips for long reaches. Pincer tips can grip contact points –up to 0.16" diameter in either electronic or electrical applications. Rated IEC 61010-031 1000V CAT III / 600V CAT IV to 6A
- General purpose probe leads with flexible PVC jacketed wire, 2mm smooth probe tips and right angle sheathed banana plugs. Rated to IEC 61010-031 1000V CAT III / 600V CAT IV to 10A.
- Spring-loaded tip miniature probe bodies. Small in size for compact probing, they are ideal for miniature probing of electronic circuits. Rated IEC 61010-031 600V CAT III to 1A.
- K-Type thermocouple with banana plug adapter. Utilize the temperature measuring capability of the 2890A DMM with this thermocouple and adapter combination. The bead-tip thermocouple measures between –50° to +392° F and is 1m long.
- 14" rugged clear plastic carrying case with foam inserts. Holds both meter and accessories.



391A True RMS DMM with Test Lead set Model 391AKIT

The 391AKIT is the perfect kit for anyone testing or measuring electronic circuits. Kit includes spring-load tip miniature probes for testing those micro-sized circuits.

Included Test Lead Accessories

- 1.5m Long Silicone 4mm Sheathed Straight to Right-Angle Plug Lead Set
- Flexible Pincer Set – Red & Black
- Probe Body Set With 2mm (.080") Diameter Tips.
- Miniature Spring-Tip Probe – Red & Black
- Tri-Fold Nylon Pouch



2704B DMM with Test Lead set Model 2704BKIT

This kit includes a perfect introduction meter and accessories. Basic starter leads for everyday use.

Included Test Lead Accessories

- 1.5m Long Silicone 4mm Sheathed Straight to Right-Angle Plug Lead Set
- Alligator Clip Set – Red Black



Multimeter Accessories



Model TL 130A

General Purpose DMM Kit

If you need only one basic accessory kit for your meter, this is the one. Attach probes or clips to the sheath plug to complete your test. Soft, flexible silicone leads make movement easy. Kit is voltage and current rated for either electronic or electrical applications.

- All components compliant to IEC61010-2-031
- Silicone Lead Wire length 60" (1.5m)
- Tri-fold Velcro Pouch

Features

	model TL 130A		
4mm Straight to Right-Angle Silicone Leads, 1.5m	1000V	CATIII	12A
Probe Bodies w/Ø2mm Tip	1000V	CATIII	36A
Alligator Style Clips	1000V	CATIII	20A
Alligator Clips	300V	CATI	3A

Model CP 3 DC/AC Current Clamp

- Converts any DMM to a current clamp
- Measures current without disconnecting circuit under test
- Measures to 400A DC or AC
- Outputs 1 mV per Amp, operates on 2V range of any DMM



Specifications

	model CP 3
(Accuracy specified at 18° to 28°C)	
Current Range	2A to 400A, DC or AC
Frequency Response (AC)	50 Hz - 400 Hz
Accuracy	±(2% reading + 2A)
Input Resistance	10kΩ min.
Maximum Conductor Size	1.1"(30mm)
Power Requirement	9V battery, NEDA 1604
Battery Life	100 hr typical
Operating Temperature	0° to 40°C, <70% RH
Storage Temperature	-20° to + 70°C, <80% RH



Model PR 28A

40kV High Voltage DMM Probe

If the voltages you need to measure are above the specifications of general purpose probes, B+K Precision has a higher voltage probe for you.

Features

	model PR 28A		
Attenuation	x1000	Impedance	1000MΩ
Voltage (AC)	20kV	Accuracy (AC & DC)	±3%
Voltage (DC)	40kV	Cable Length	48" (1.2m)
Bandwidth	60Hz		



Model TL-50

Maxi-Pro DMM Kit

Complete accessory kit for all your testing needs. Includes soft, flexible silicone lead wire easy movement and Tri-Fold Velcro Pouch for convenient storage.

- All components compliant to IEC61010-2-031
- Silicone Lead Wire length 60" (1.5m)
- Tri-fold Velcro Pouch

Features

	model TL-50		
4mm Straight to Right-Angle Silicone Leads, 1.5m	1000V	CATIII	12A
Probe Bodies w/Ø2mm Tip	1000V	CATIII	36A
Pincer Style Clips	1000V	CATIII	6A
Alligator Clips	300V	CATI	3A
Spade Lug Adapters	42V (1000V)		36A
Banana Plug Adapters	42V (1000V)		36A
Fully Insulated Alligator Clips	1000V	CATIII	20A

Replacement Test Leads

Model TL 2A

Deluxe Test Lead Sets

- IEC61010 1000V CATIII Rating
- Silicone Lead Wire length 60" (1.5m)
- Black Alligator Clip included
- Threaded tips fits TL-3 Accessory kit items



Model TL 3

Probe Accessory Kit

- Threaded accessories to fit TL-2A probes – Black and Red pairs (except for alligator clip)
- Alligator clip, Red only
- Spring hook clips
- 4" Sharp extension tips to reach tight test points
- No. 10 Spade lugs



Model TL 1

Model TL 4

- Economical replacement test leads. TL-1 has safety shrouded banana plugs. TL-4 has un-shrouded banana plugs.
- 1500V 3A ratings
 - PVC lead wire, 40" (1.0m)
 - Black and Red Alligator clips



TL 8

Surface Mount Tweezers

- Two conductor leads
- 400V rms, 1A





Oscilloscopes

WHAT DO OSCILLOSCOPES DO?

B+K Precision® offers a broadest line of oscilloscopes including digital and analog/digital oscilloscopes ranging from a 30 MHz analog dual-trace unit to 100MHz lab scope. No matter what your application design, service, production or home use, B+K Precision® has an oscilloscope that meets your requirements.

An oscilloscope is a test instrument that visually displays an electronic signal on a display screen. The display shows voltage (vertical) and time (horizontal). You can view the screen and through interpretation of the settings on the oscilloscope determine the instrument's voltage, and the general characteristics of the signal.

WHERE ARE OSCILLOSCOPES USED?

An oscilloscope is a test instrument that can be used in a wide variety of applications:

EDUCATION - used in technical schools to demonstrate electrical theory

DESIGN - used in circuit design to verify design parameters

SERVICE - used for the repair of electronic equipment

MAINTENANCE - used to verify operation for set-up or repair equipment

FIELD SERVICE - used for in-the-field repair of equipment

MANUFACTURING - used as part of the manufacturing process to verify performance parameters of UUTs (Units Under Test)

QUALITY CONTROL - used for final testing of equipment.

WHAT IS BANDWIDTH?

Bandwidth is the frequency range of signals that can be viewed on the oscilloscope. When selecting an oscilloscope, consider present and future bandwidth requirements of the instrument.

ANALOG VS. DIGITAL STORAGE

B+K Precision® provides analog, digital, and mixed analog/digital oscilloscopes. Analog oscilloscopes range from 30 MHz to 100 MHz in bandwidth. The digital and analog/digital model provides a bandwidth of 20 & 25MHz. The main benefits of digital storage

oscilloscopes are:

- **capability to store waveforms for analysis**
- **ability to view / store pre-trigger information**
- **ability to detect / display / capture glitches**
- **ability to get a hard copy printout of the captured signal**
- **ability to view slow events**
- **ability to view one time events**

ARE OSCILLOSCOPES HARD TO USE?

B+K Precision analog and digital oscilloscopes have a number of features that provide ease of use. These features include:

AUTOSET - provides automatic setup of time base, vertical axis and trigger parameters of the signal being viewed. This allows most signals to be displayed. You can then readjust the timebase and vertical axis as you require.

Automatic Measurements - Depending on the model, up to 17 automatic measurements are displayed by readouts on the screen.

Analog or Digital Operation - B+K Precision® analog / digital oscilloscope provides the benefits of both analog and digital operation in one unit. A single button is used to go from analog to digital storage operation.

OSCILLOSCOPE SELECTION

Refer to the following page for definitions of common digital terminology. When selecting an oscilloscope, answer these questions: Considering present and future needs, what maximum bandwidth will be required? Will you need to store the signals you are viewing? Review the selection chart on page 76 to prescreen all models. Then turn to the specific model number page for complete specifications.

OSCILLOSCOPE TERMS

ACCELERATING VOLTAGE—The internal voltage that causes trace illumination on the oscilloscope display. A higher voltage is needed at fast sweep speeds.

BANDWIDTH—The frequency range of signals that can be observed on the oscilloscope with minimal degradation. Typically, bandwidth is specified in megahertz (MHz) and is the maximum frequency at which signals are within -3dB in amplitude.

DELAYED TIME BASE—Allows a single signal to be viewed at two different sweep speeds, by expanding a portion of the waveform and starting at some point after the main time base begins. This is more useful than merely magnifying the display because it allows all parts of the main sweep signal to be observed with any desired amount of expansion or horizontal magnification.

DUAL TIME BASE—A dual time oscilloscope allows you to view one signal at two different sweep speeds simultaneously, with delayed trigger. One sweep can be used to observe a complete waveform (such as a full frame of a video signal) while the second sweep is used to expand the signal and view only a portion of it (such as a single line of the same video signal).

EXTERNAL TRIGGER—Externally supplied signal that starts the sweep.

INPUT IMPEDANCE—The AC and DC resistance that a signal “sees” at the oscilloscope input.

RISE TIME—The minimum time that it takes the CRT beam to rise from the 10% mark on the CRT graticule to the 90% mark on the graticule. Oscilloscope rise time specifications are directly related to bandwidth.

SWEEP—The motion of the CRT beam from left to right that causes the trace to appear. A sweep time of 0.1 ms/div means that the beam moves across one division of the CRT in 0.1 ms. Faster sweep speeds are required to view higher frequency signals.

SWEEP MAGNIFIER—Allows a portion of a displayed waveform to be magnified (typically X10) without actually shortening the sweep time setting. This is an advantage over simply increasing the sweep speed because increasing the sweep speed can result in the desired portion of the waveform disappearing off the screen. Additionally, this feature increases the maximum sweep speed by the magnification factor.

TRIGGER—Signal that starts the sweep of the oscilloscope CRT beam across the display. The trigger level controls the amplitude at which the sweep will begin.

VERTICAL SENSITIVITY—The signal level required to cause a single division of vertical deflection. For example, for a vertical attenuator setting of 5 mV/div, a 5 mV peak signal will produce one division of vertical deflection.

V MODE TRIGGERING—V mode triggering permits each waveform viewed to become its own trigger signal. In dual trace operation, the trigger source alternates between channels. Sometimes referred to as alternate triggering.

VERTICAL ATTENUATOR—The precision input circuit controls the level of the input signal. Usually this circuit consists of calibrated steps in

a 1-2-5 sequence (i.e., 10 mV/div, 20 mV/div, 50 mV/div. etc) which allow the oscilloscope to display signals with levels from many volts to only a few millivolts.

VIDEO SYNC—Allows vertical (TV V) or horizontal (TV H) video sync pulses to be selected for triggering. Vertical sync pulses are selected to view vertical fields or frames of video and horizontal sync pulses are selected for viewing horizontal lines of video. Sometimes referred to as TV sync.

X-Y DISPLAY—Mode of operation which displays a graph of two voltages. The Y axis is the vertical axis (usually channel 1) and the X axis is the horizontal axis (usually Channel 2).

Z-AXIS—Allows an external signal to control the intensity of the CRT beam. Also referred to as intensity modulation.

DIGITAL OSCILLOSCOPE TERMS

BYTE—Usually contains eight bits of digital information (sometimes contains 10 to 12 bits). Also referred to as a word.

EQUIVALENT TIME SAMPLING—A method of sampling used by some Digital Storage Oscilloscopes to allow them to capture repetitive waveforms with frequencies that are higher than the sampling rate.

HARD COPY—A paper copy of the displayed waveform made by an external plotter.

HORIZONTAL RESOLUTION—The number of points possible across the oscilloscope display. Usually, if the horizontal resolution is 1 K (1024), there will be 1000 points (samples) plotted across the display from the far left vertical graduation to the far right graduation. (100 points or samples per division).

INTERFACE—Ability to talk to and/or receive commands from an external computer or other electronic device.

MEMORY—The electronic circuitry that stores the digitized signal. For DSO's, memory is usually specified in kilobytes. One kilobyte contains 1024 bytes of information.

PRE-TRIGGER—The ability of a DSO to view signals before the trigger. This allows the user to determine the cause of many undesired effects in electrical and electronic equipment.

REFRESH MODE—The trace moves across the CRT from left to right (just like a conventional oscilloscope) and the display is refreshed (updated) each time a trigger occurs.

ROLL MODE—The trace moves across the CRT from right to left (like a chart recorder) and is continually updated.

SAMPLE—The digital representative of an instantaneous value of the digital storage oscilloscope's input signal. The DSO works by taking sample of the waveform at various points.

SAMPLING RATE—The rate at which the input signal is converted to a digital signal. Maximum sampling rate is usually expressed in MS/s (megasamples per second).

SINGLE SHOT MODE—Used for capturing one-time events or pre-trigger information.

VERTICAL RESOLUTION—The number of vertical points that are possible on the oscilloscope display. An eight bit DSO allows a vertical resolution of 256, a ten bit DSO allows 1024 points, and a twelve bit DSO allows 4096 points.

Oscilloscopes

Selection Guide

Analog Bandwidth (MHz)		Sample Rate	Memory per Channel	Cursors & Readout	Data Output	Model	Page	
25		250MS/s	2 x 1K	YES	USB	2530	77-79	
20		10MS/s	2 x 2K	NO	Analog	2522B	80	
All B+K Precision digital storage oscilloscopes are dual channel and have Equivalent Time Sampling.								
Bandwidth (MHz)	Vertical Sensitivity	Max Sweep Rate	Delayed Dual/Sweep TimeBase	Single Delay Line	Y-Mode Alternate Trigger	External Trigger	Model	Page
100	5mV/div to 100MHz	20ns/div	YES	YES	NO	YES	2190B	81
60	5mV/div to 60MHz	0.1μs/div	YES	YES	YES	YES	2160A	82
40	5mV/div to 40MHz	10ns/div	YES	NO	NO	YES	1541D	83
30	5mV/div to 30MHz	0.1μs/div	YES	NO	YES	YES	2125A	84
30	5mV/div to 30MHz	0.1μs/div	NO	NO	YES	NO	2120B	85
30	5mV/div to 30MHz	0.1μs/div	NO	NO	YES	NO	2121*	86
All B+K Precision analog oscilloscopes are dual channel and have Video Sync (TV-V and TV-H). * Built-in 50 MHz frequency counter								
Bandwidth (MHz)		Max. Voltage	Description			Model	Page	
90 MHz		600 V	X1, X10 selectable, for scopes to 60 MHz			PR-33A	88	
150 MHz		600 V	X1/X10/REF selectable, for scopes to 100 MHz			PR-37AG	88	
150 MHz		600 V	X1/x10 selectable Low Capacitance			PR-150	88	
250 MHz		1200V	X100, fixed, high voltage probe, for scopes to 250 MHz			PR-100A	88	
100kHz - 650 MHz		200V	Demodulator Probe, for all scopes			PR-32A	87	
Dimensions		Weight	Material			Model	Page	
15 x 7.5 x 17.5" (381 x 191 x 445mm)		2.36 lbs. (1070g)	1000D Navy Cordura 400D nylon pack cloth			LC-210A	153	

Oscilloscopes

Digital Storage Oscilloscope 25MHz, 250MSa/s

Model 2530

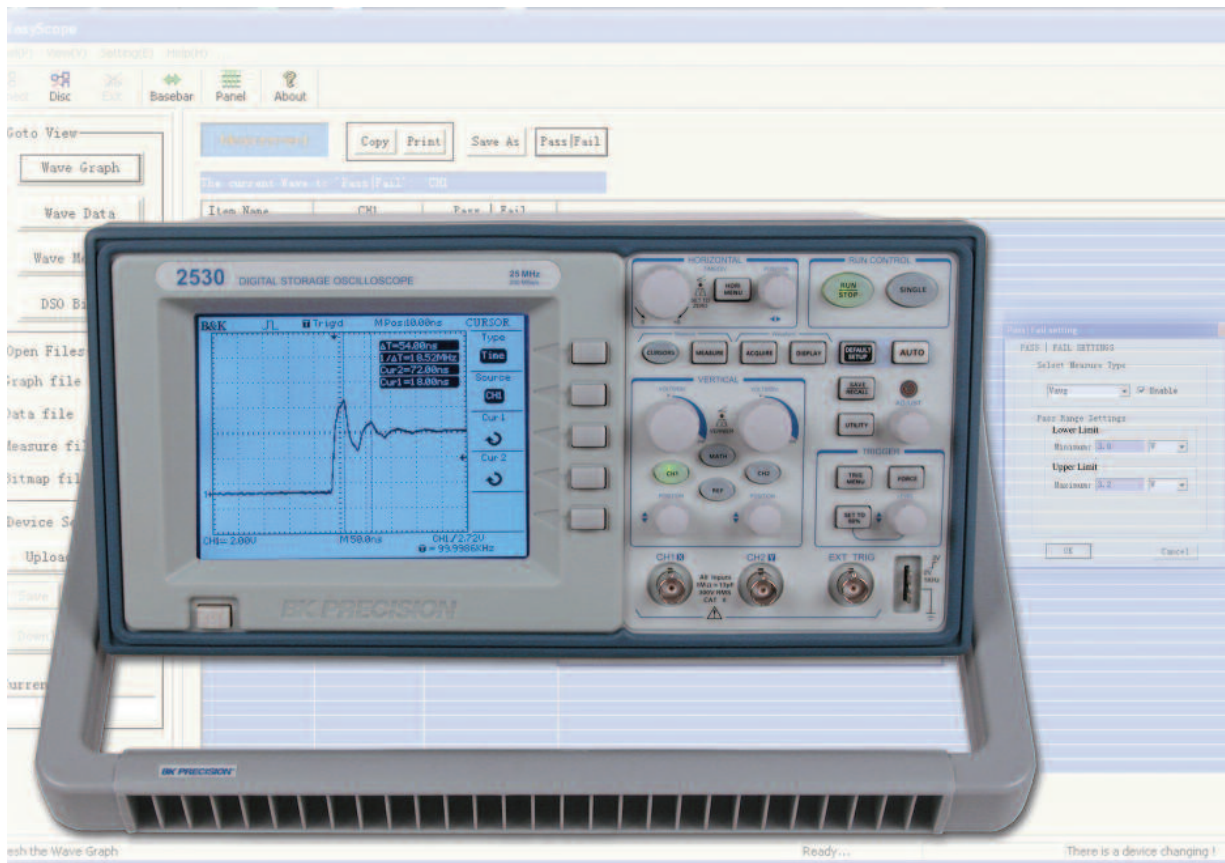

ESSENTIAL FEATURES FOR THE COST CONSCIOUS USER

The 2530 Digital Storage Oscilloscope delivers essential features and reliable performance at a price you can afford. Analog style knobs and controls combined with Autoset functions make this oscilloscope easy to use. Advanced triggering, automatic measurements and FFT functions provide you with many options to debug your circuits. Additionally, the instrument comes with PC Software that lets you easily capture, save and analyze waveforms and measurement results. The 2530 is an ideal education and training tool and also well suited for applications in service and repair.

- One touch automatic setup for ease of use (Auto)
- 25 MHz bandwidth, 250MSa/s sample rate
- 4000 point record length for each channel
- Capture, save and analyze waveform data with the included EasyScope Application Software

- Cursors with readouts
- Eleven automatic measurements
- FFT standard plus 4 additional math functions
- Extensive Trigger capabilities including Pulse Width and line-selectable Video trigger
- Save/Recall setup and waveform data

- Security loop
Use the built-in cable channel to secure your oscilloscope to your location

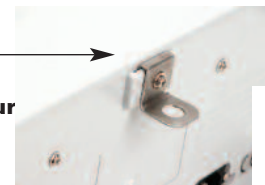

Oscilloscopes

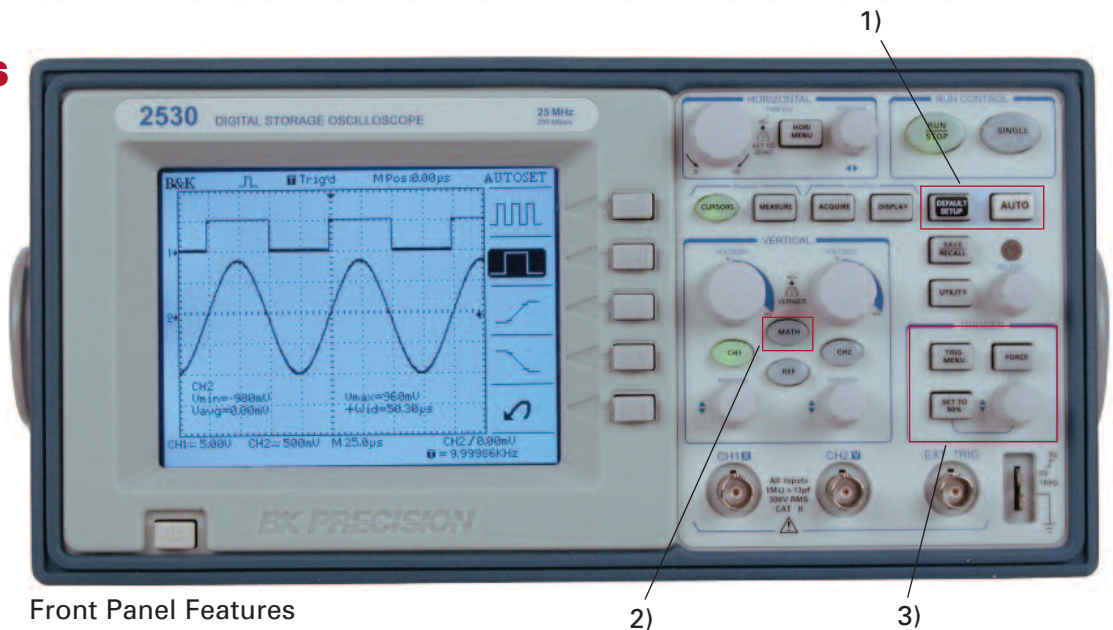

Front Panel Features

1) Easy setup and use

The AUTO button identifies the input signal and automatically sets up the vertical, horizontal and trigger controls to produce a useable display. You can customize the display by selecting option single cycle, multiple cycle, rising or falling edge. Press the DEFAULT button to instantly restore the default setting. Users familiar with analog oscilloscopes will appreciate the analog style controls and features.

2) Waveform analysis with math and FFT

Analyze your signal with add, subtract multiply and divide functions. View the signal's frequency domain spectrum and perform harmonic distortion analysis.

3) Advanced triggering

Isolate the signal with advanced triggering including pulse width and selectable video trigger.

Simple Documentation and Analysis

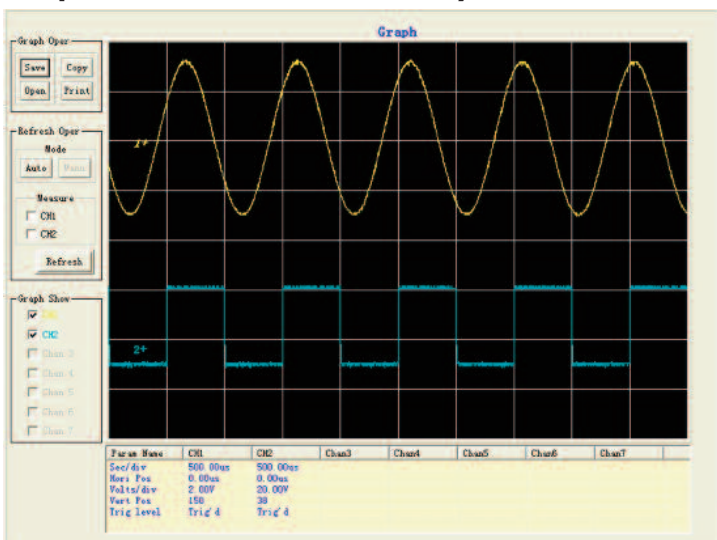

Auto calibration

Automatically calibrate the instrument's vertical and horizontal system.

Stored setups and waveforms

Store up to 10 waveforms and 2 setups for future reference and use.

11 automatic measurements

Increase your efficiency. Execute and display 11 measurements simultaneously.

XY Mode

Unlike comparable models in the market, the 2530 supports settable sample rates of 5kSa/s – 200kSa/s when operating in XY mode.

The included Easyscope software provides seamless integration between oscilloscope and PC. Capture and transfer waveforms, screen images, setups and measurement results to a Windows PC via the USB device port on the back of the instrument.

- Save waveform data in csv (Microsoft Excel) format for post acquisition analysis
- Document your results: Print, save or copy/paste waveform data and measurement results. Save and print bitmap images and setups
- Capture waveforms and measurement results manually or automatically at user defined intervals. In automatic mode, the smallest refresh rate is 0.5 seconds, allowing for virtually real time waveform capture
- Generate real-time Pass/Fail verdicts for captured measurement results

Oscilloscopes

Specifications

model

2530

Performance Characteristics

Bandwidth	25 MHz
Real time sample rate on each channel	250 MSa/s
Channels	2
Display	1/4 VGA Monochrome LCD
Rise Time	< 14ns
Record Length*	4000 points
Vertical Resolution	8 bits
Vertical Sensitivity	2mV - 5V/div
DC gain accuracy	±3.0%
Maximum Input Voltage	300 Vrms, CAT II (between signal and reference BNC connector)
Position Range	2mV - 100mV range ±2V 200mV - 5V range: ±40V
Time Base range	2.5 ns/div - 50 s/div
Timebase accuracy	100 ppm
Input Coupling	AC, DC, GND
Input Impedance	1MΩ in parallel with 13pf
Vertical and Horizontal Zoom	Vertically or horizontally expand or compress a live or stopped waveform
I/O interface	USB device port for connection to PC. (Requires included EasyScope Software for use)

* The instrument displays 2500 points. 4000 points can be retrieved from internal memory with the included EasyScope application. This feature is supported for a time base settings range of 2.5μs/Div-50ms/Div (scan mode is not active)

Acquisition Modes

Sample	Display sample data only
Peak Detect	
Average	Waveform averaged, selectable from 4, 16, 32, 64, 128, 256
Scan Mode	For time base settings 0.1s/div-50s/div

Trigger System

Trigger Types	Edge, Pulse Width, Video*
Trigger Modes	Auto, Normal, Single
Trigger Coupling	AC, DC, LF reject, HF reject
Trigger Source	CH1, CH2, AC line, Ext, Ext/5

*Support formats PAL/SECAM, NTSC. Triggers on odd or even field, all lines or line number

Cursors

Types	Amplitude, Time
Measurements	∅V, ∅T, 1/∅T

Specifications (Continued)

Automatic Waveform Measurement

Time	Rise time, Fall Time, Cycle Frequency, Period, Positive Pulse Width, Negative Pulse width
Voltage	MAX, MIN, Peak-Peak, Average, Vrms
Frequency	Hardware counter provides frequency readout of trigger source with 6 digit resolution

Waveform Math

Math function	FFT, add, subtract, multiply, divide
FFT	Windows: Hanning, Hamming, Blackman, Rectangular 1024 sample points

Autoset

Single button automatic setup of both channels for vertical, horizontal and trigger systems

Display

Display Mode	1/4 VGA (5.7") monochrome LCD (320x240) with adjustable contrast and inverse video
Display Types	Point, Vector
Persistence	Off, 1s, 2s, 5s, infinite
Waveform Interpolation	Sin(x)/x, Linear
Format	YT and XY

Power Requirements

100-240 VAC, 50VAmx, 45Hz to 440Hz

Environmental

Temperature	Operating: 0°C to +55°C Nonoperating: -40°C to +70°C
Humidity	Operating: 95%RH, 40°C Nonoperating: 90%RH, 65°C
Altitude	Operating to 4000m
Pollution Degree	Pollution degree 2 for indoor use only.

Electromagnetic compatibility and Safety

EMC	This oscilloscope is in compliance with council EMC directive 2004/108/EC
Safety	EN61010-1:2001

General

Dimensions	11.4in x 5.9in x 5.9in 290mm (Width) x 150mm (Height) x 300mm
Weight	10 lbs (4.6 kg)

Accessories

One Year Warranty

SUPPLIED: User Manual, 10:1 Probe set (2 pieces), Power cord, USB interface cable, EasyScope Software Installation disk
OPTIONAL: PR 37A 10:1 Probe, PR 32A Demodulator Probe, PR-55 High Voltage Probe

20MHz Analog / Digital Storage Oscilloscope

Model 2522B

- 20MHz analog bandwidth
- 10MS/s sampling rate each channel
- 2k memory per channel
- 1GHz equivalent time sampling (at 0.1 μ s/div)
- Pre-trigger capture

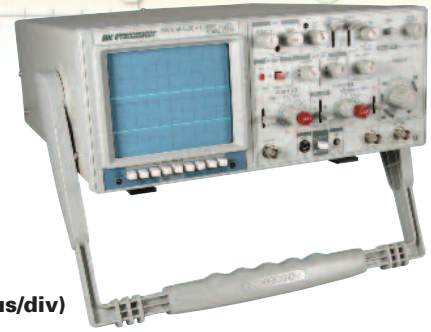

Digital Mode Specifications

	model
	2522B
Storage Word Size	2048 x 8 bits/channel; (2 k/channel with direct sampling, 1 k/channel with equivalent time sampling).
Vertical Resolution	1 in 256, approximately 25 steps/div.
Horizontal Resolution	1 in 2048, approximately 200 samples/div.
Sampling Rate	10 M samples/sec to 4 samples/sec, reduced in proportion to time base. Direct sampling at time base settings of 20 μ s/div and slower, equivalent time sampling at time base settings of 10 μ s/div and faster.
Time Base Expander	For storage of slow time events, time base steps 10 ms/div and slower have selectable 1/1 or 1/100 rate. 1/100 rate expands time base from 1 sec/div to 50 sec/div in 1-2-5 sequence.
Equivalent time Sampling Bandwidth	20MHz for repetitive waveforms.
Dot Joining	Linear interpolation between samples.

DIGITAL DISPLAY MODES

Roll	Stored data and display updated continually.
Refresh	Stored data and display updated by triggered sweep.
Hold	Freezes channel 1 and channel 2 data immediately.
Save CH 2	Freezes channel 2 data immediately.
Pretrigger Storage	Available in single shot mode, switchable to 0% or 50%.
LED Indicators	Trigger (green), Arm (red), Pen Down (red).

PLOT OUTPUT

CH1 and CH 2 Outputs OUTPUT and CH 2 OUTPUT	Selected by PLOT switch on rear panel. Output via CH 1 jacks on rear panel. Amplitude 0.1 V/div (1 V maximum).
Output Sweep Rate	Output sweep rate is 1/10 of TIME/DIV setting (and 1/100 switch when applicable).
Pen Lift Output	Available at Pen Down jack on rear panel. TTL high, Pen Up. TTL low, Pen Down.

Analog Mode Specifications

VERTICAL AMPLIFIERS (CH 1 and CH 2)

Sensitivity	5 mV/div to 5 V/div in 1-2-5 sequence, 10 steps. Vernier control provides fully adjustable gain between steps. Pull x5 increases maximum sensitivity to 1 mV/div (at reduced bandwidth).
Accuracy	$\pm 3\%$, $\pm 5\%$ at x5 MAG
Input Resistance	1M Ω +2%
Input Capacitance	25pF + 10pF
Frequency Response	5 mV to 5 V/div: DC to 20 MHz (-3 db). x5: DC to 10MHz (-3dB)
Rise Time	Approximately 17.5 ns (overshoot $\leq 3\%$)
Polarity Reversal	CH 2 only
Maximum Input Voltage	400 V (DC + AC peak)

MAXIMUM UNDISTORTED AMPLITUDE

DC-to-20 MHz	4 divisions
DC-to-10 MHz	8 divisions
OPERATING MODES	
CH 1: CH 1, single trace	CH 2: CH 2, single trace
ALT	Dual trace, alternating
CHOP	Dual trace, chopped
ADD	Algebraic sum of CH 1 + CH 2

SWEEP SYSTEM

Sweep Speed	0.1 μ s/div to 2 s/div in 1-2-5 sequence, 23 steps. Vernier control provides fully adjustable sweep time between steps.
Accuracy: +3%	Sweep Magnification: 10X, +6%
Hold off	variable.

TRIGGERING

Modes: AUTO (free run) or NORM. Source: CH1, CH2, ALT, EXT, LINE.	
Maximum External Trigger Voltage: 200V (DC + AC peak).	
Sensitivity	Internal - 0.5 division, External - 500 mV.

TRIGGER COUPLING

AC	30 Hz to 30 MHz.
TV H/HF:	Used for triggering from horizontal sync pulses. Low frequencies are attenuated.
TV V DC/LF:	Used for triggering from vertical sync pulses. High frequencies are attenuated. Direct coupled.

HORIZONTAL AMPLIFIER(Input thru CH 1 Input)

X-Y Mode	Switch selectable using X-Y switch
CH 1: X axis CH 2: Y axis	
Sensitivity	Same as vertical channel 1
Accuracy	Y-Axis: $\pm 3\%$. X-Axis: $\pm 6\%$
Input Impedance	Same as vertical channel 1
Frequency Response	DC to 2 MHz typical (-3 dB) (to 6 divisions horizontal deflection)
X-Y Phase Difference	Approximately 3° at 50 kHz
Maximum Input Voltage	Same as vertical channel 1

Other Specifications

CRT	
Type	Rectangular with internal graticule
Display Area	8 x 10 div (1 div = 1 cm).
Accelerating Voltage	2 kV
Phosphor	P31
Trace Rotation	Electrical, front panel adjustable
ENVIRONMENT	
Within Specified Accuracy	50° to 95°F (10° to + 35°C), 85% maximum RH
Full Operation	32° to 104°F (0° to + 40°C), 85% maximum RH
Storage	-4° to 158°F (-20° to + 70°C)
OTHER	
CH 1 Output	(on rear panel)
Output Voltage	25mV/div (nominal into 50 Ω load)
Output Impedance	Approximately 50 Ω
Frequency Response	20 Hz to 10MHz, -3 dB into 50 Ω
Cal/Probe Compensation Voltage	0.5 Vp-p + 3% square wave, 1kHz nominal
Power Requirements	110 V/125/220/240 VAC, 50/60 Hz, approximately 60 W
Dimensions (HxWxD)	5.2 x 12.8 x 15.6" (132 x 324 x 397 mm)
Weight	19 lb (8.6 kg.)

Accessories

Three Year Warranty

SUPPLIED:	Instruction Manual, Two PR 33A x1/x10 Probes or equivalent, AC Power Cord, Spare Fuse
OPTIONAL:	PR 32A Demodulator Probe, PR 37AG x1/x10/REF Probe, PR 100A x100 Probe, PR-55 High Voltage x1000 Probe, LC 210A Carrying Case



100MHz Analog Oscilloscope

Model 2190B

- Dual time base oscilloscope (2 channel)
- 5mV/division sensitivity
- Sweeps to 5ns/division
- 23 calibrated ranges, main time base
- Signal delay line
- 15 kV accelerating voltage
- Channel 2 output

Specifications

		model
		2190B
VERTICAL AMPLIFIERS (CH 1 and CH 2)		
Sensitivity	5mV/div to 5 V/div. 1 mV/div to 1V/div (at X5 MAG)	
Attenuator	10 calibrated steps in 1-2-5 sequence. Vernier control provides fully adjustable sensitivity between steps, adjustment range 1/1 to 1/2.5	
Accuracy	±3% (±5% at X5 MAG)	
Input Impedance	1MΩ + 3%	
Input Capacitance	25 pF ± 10pF	
Frequency Response	DC: DC to 100 MHz (-3 dB)	
X5 MAG	DC to 20 MHz (-3 dB)	
AC	10Hz to 100 MHz (-3 dB)	
Rise Time	3.5 ns (Overshoot ≤5%)	
Signal Delay Time	Variable	
Square Wave Characteristics	Overshoot less than 5%, 10 mV/div range	
	Other ranges within 5% additional	
Maximum Input Voltage	400V (DC + AC peak)	
EXTERNAL TRIGGER		
Input Impedance	1mΩ, 30pF	
Maximum Input Voltage	300V (DC + AC peak)	
HORIZONTAL AMPLIFIER		
X-Y Mode	X Axis = CH 1, Y Axis = CH 2	
Sensitivity	5 mV/div to 5 V/div, CH 1 and CH 2	
Accuracy	±3% calibrated position, ±6% using x10 MAG	
Frequency Response	DC to 2 MHz (-3dB)	
CH2 (Y) OUTPUT		
Output Voltage	Approx. 100mV/div open circuit Approx. 50 mV/div into 50Ω	
Freq. Response	50 Hz to 30 MHz.	
Output Impedance	approx. 50Ω	
CRT		
Type	Rectangular with integral graticule	
Display Area	8 x 10 div (1 div = 1 cm)	
Accelerating Voltage	15kV	
Phosphor	P31	
Scale Illumination	None	
Trace Rotation	Electrical, front panel adjustable	
Other Specifications		
Z Axis (Intensity Modulation)	Sensitivity: 3 V or greater, TTL level. Negative polarity increases brightness	
Input Impedance	15 kΩ	
Usable Freq. Range	DC to 3.5 MHz	
Maximum Input Voltage	20 V (DC + AC peak)	
CAL/Probe Compensation		
Waveform	Positive going squarewave	
Output Voltage	0.5 V p-p ± 3%	
Frequency	Approx. 1kHz	
Duty Cycle	50 ± 5%	
Power Requirements	100/120/220/240/ VAC ± 10%, 50/60 Hz, approximately 55 W	
Dimensions (HxWxD)	12.76 x 15.68 x 5.2" (324 x 398 x 132 mm)	
Weight	18.7 lbs (8.5 kg)	
ENVIRONMENT		
Within Specified Accuracy	50° to 95°F (10° to 35°C), 85% maximum RH	
Full Operation	32° to 104°F (0° to +40°C), 85% maximum RH	
Storage	-4° to 158°F (-20° to +70°C)	
Accessories Three Year		
SUPPLIED: Instruction Manual, Two PR 37A x1/x10/Ref. Probes or equivalent, AC Power Cord, Spare Fuse		
OPTIONAL: PR 32A Demodulator Probe, PR 37AG x1/x10/REF Probe, PR 100A x100 Probe, PR-55 High Voltage x1000 Probe,		

60 MHz Analog Oscilloscope

Model 2160A

- 5mV/div sensitivity
- 23 calibrated ranges-main time base
- 23 calibrated ranges-delayed time base
- Signal delay time
- Component tester
- Z axis input
- Single sweep



Specifications

		model
		2160A
VERTICAL AMPLIFIERS (CH 1 and 2)		
Sensitivity	5mV/div to 1V/div x 5mag	
Attenuator	1-2-5 sequence, plus x 5 gain step, Vernier control provide fully adjustable sensitivity between steps range 1/1 to at least 1/2.5	
Accuracy	±3%, 5mV to 5V/div; ±5%, 1mV, 2mV/div	
Input impedance	1MΩ ±2%	
Input Capacitance	25pF ±10%	
Frequency Response	DC to 60 MHz	
Rise Time	5.8ns (Overshoot <5%)	
Operating Modes	CH1, CH2, Dual, Alternate Chop	
Polarity Reversal	CH 2 invert	
Maximum Input Voltage	400V (dc + AC Peak), 800 VAC p-p	
SWEEP SYSTEM		
Sweep Display Modes	Main, Mix, Delay	
Hold Off Time	5:1 continuously variable	
Main Sweep		
Sweep Speed	0.1μs/div. to 2.0s/div. in 1-2-5 sequence, 23 steps	
Accuracy	±3%	
Variable Time Control	5:1, uncalibrated, continuously variable between steps	
Sweep Magnification	10 x, ±10%, extended sweep speed up to 10ns/div	
Delay Sweep		
Sweep Speed	0.1 μs/div. to 2.0s/div. in 1-2-5 sequence, 23 steps	
Accuracy	±3%	
Sweep Magnification	10 x, ±10%, extended sweep speed up to 10ns/div	
Delay Time Position	Variable control to locate desirable waveform for extending	
Triggering		
Trigger Coupling	AUTO, NORM, TV-V, TV-H	
Trigger Source	CH1, CH2, ALT, EXT. LINE	
Slope	+/-	
HORIZONTAL AMPLIFIER		
(Input through channel 2 input)		
X-Y Mode	CH 1: Y axis. CH 2: X axis	
Sensitivity	Same as vertical channel 2	
Accuracy	±3%, Y axis; ±5% X axis	
Input Impedance	Same as vertical channel 2	
Frequency Response	DC: DC to 1MHz (-3 dB). AC: 5 Hz to 2 MHz (-3 dB)	
X-Y Phase Difference	3° at 50 kHz	
Maximum Input Voltage	Same as vertical channel 2	
CH 2 Output (on rear panel)		
Output Voltage	50 mV/div (nominal into 50 Ω load)	
Output Impedance	Approximately 50 Ω	
Frequency Response	20Hz to 60MHz, -3dB into 50V	
CRT		
Type	6-inch rectangular with internal graticule	
Display Area	8 x 10 div (1 div = 1 cm)	
Accelerating Voltage	12 k	
Phosphor	P31	
Scale Illumination	Continuously variable	
Trace Rotation	Electrical, front panel adjustable	
COMPONENT TESTER		
Components Tested	Resistors, capacitors, inductors, and semiconductors	
Test Voltage	6V rms maximum (open)	
Test Current	11mA maximum (shorted)	
Test Frequency	Line frequency (60 Hz in USA)	
Other Specifications		
Cal/Probe		
Compensation Voltage	2.0 V p-p ±2% square wave, 1 kHz nominal	
Sweep Output	TTL level allows synchronization of external equipment with scope sweep	
Intensity Modulation		
Input Signal	TTL level, intensity increasing with more negative levels	
Input Impedance	Approx. 1 kΩ	
Usable Freq. Range	DC to 5 MHz	
Maximum Input Voltage	5V (DC + AC peak)	
Environment		
Within Specified Accuracy	50° to 95°F (10° to 35°C), 85% maximum RH	
Full Operation	32° to 122°F (0° to +50°C), 10 - 80% RH	
Storage	-22° to 158°F (-30° to +70°C), 10 - 90% RH	
Power Requirements	110/120/220/240 V ±10%, 50/60 Hz	
Dimensions (H x W x D)	12.76 x 15.68 x 5.2" (324 x 398 x 132mm)	
Weight	16.75 lbs. (7.6kg)	
Accessories		Three Year Warranty
SUPPLIED: Instruction Manual, Two PR 33A x1/x10 Probes or equivalent, AC Power Cord, Spare Fuse		
OPTIONAL: PR 32A Demodulator Probe, PR 37AG x1/x10/REF Probe, PR 100A x100 Probe, PR-55 High Voltage x1000 Probe, LC 210A Carrying Case		

40 MHz Analog Oscilloscope



Model 1541D

- 5mV/div sensitivity
- 19 calibrated sweeps
- Video sync separators
- X10 sweep magnification

Specifications

model
1541D

VERTICAL AMPLIFIERS (CH 1 and CH 2)

Sensitivity	5 mV/div to 5 V/div, 1 mV/div, with X5 gain
Accuracy	5 mV/div to 5 V/div, $\pm 3\%$ (X5 gain), $\pm 5\%$
Input Impedance	1M Ω $\pm 2\%$, 25pF $\pm 10\%$
Frequency Response	DC to 40 MHz (-3dB), DC to 7 MHz (-3dB) at X5 gain
Rise Time	8.8 ns (Overshoot $\leq 5\%$)
Operating Modes	CH 1; CH 2; DUAL; Alternate/Chop; ADD
Chop Frequency	Approximately 250kHz
Max Input	400 V (DC + AC peak)

SWEEP SYSTEM

Sweep Speed	0.2 μ s/div to 0.2 s/div in 1-2-5 sequence; 20 steps, vernier control provided
Accuracy	$\pm 3\%$
Sweep Magnification	10x
Hold Off Time	5:1 Continuously variable

TRIGGERING

Trigger Modes	Auto, Norm
Trigger Source	Ch 1, CH 2, LINE, EXT, ALT
Trigger Coupling	AC, TV-V, TV-H, NORM

HORIZONTAL AMPLIFIER (Input through EXT TRIG)

X-Y Mode	CH1: Y axis, CH2: X axis
Sensitivity	Same as vertical CH1
Accuracy	Y axis $\pm 3\%$, X axis $\pm 6\%$
Input Impedance	same as vertical CH1
Frequency Response	DC to 1MHz (-3dB)

CRT

Display Area	6 inches diagonal, rectangular screen with internal graticule 8 x 10 div (1 div = 1 cm)
Accelerating Voltage	12 kV
Trace Rotation	Front panel adjustable
Phosphor	B31

Other Specifications

Calibrating Voltage	1kHz positive square wave, 2Vp-p, $\pm 3\%$
---------------------	---

ENVIRONMENT

Within Specified Accuracy	50° to 95°F (10° to 35°C), $\leq 85\%$ RH
Full Operation	32° to 104°F (0° to 40°C), $\leq 85\%$ RH
Storage	-4° to 158°F (-20° to +70°C)
Power Requirements	100/120/220/240 V $\pm 10\%$, 50/60 Hz, approximately 38W
Dimensions (HxWxD)	12.8 x 15.7 x 5.2" (324 x 398 x 132 mm)
Weight	16.8 lbs. (7.6 kg)

Accessories

Three Year Warranty

SUPPLIED:	Instruction Manual, Two PR 33A x1/x10 Probes or equivalent, AC Power Cord, Spare Fuse
OPTIONAL:	PR 32A Demodulator Probe, PR 37AG x1/x10/REF Probe, PR 100A x100 Probe, PR-55 High Voltage x1000 Probe, LC 210A Carrying Case

30 MHz Analog Oscilloscope

Model 2125A

- Delayed sweep in 23 steps
- Built-in component tester for capacitors, inductors, diodes, transistors, zener diodes
- 23 step time base to 0.1ms/div
- Deluxe handle/tilt stand



Specifications

		model
		2125A
VERTICAL AMPLIFIERS (CH 1 and CH 2)		
Sensitivity	5 mV/div to 5 V/div, 1 mV/div to 1 V/div at x5	
Attenuator	10 steps in 1-2-5 sequence. Vernier control provides full adjustment between steps	
Accuracy	± 3%, ± 5% at x5	
Input Resistance	1 MΩ ± 2%	
Input Capacitance	25 pF ± 10pF	
Frequency Response	5 mV to 5 V/div: DC to 30 MHz (-3dB) X5: DC to 10 MHz (-3dB)	
Rise Time	12ns (Overshoot ≤ 5%)	
Operating Modes	CH 1: CH 1, single trace	
CH 2	CH 2, single trace	
ALT	dual trace, alternating	
CHOP	dual trace, chopped	
ADD	algebraic sum of CH 1 + CH 2	
Polarity Reversal	CH 2 only	
Max. Input Voltage	400 V (DC to AC peak)	
SWEEP SYSTEM		
Operating Modes	Main, mix (both main sweep and delay sweep displayed), or Delay (only delay sweep displayed), X-Y	
Main Sweep Speed	0.1 μs/div to 2.0 s/div in 1-2-5 sequence, 23 steps Vernier control provides fully adjustable sweep time between steps	
Accuracy	± 3%	
Sweep Magnification	10X, ± 5%	
Delayed Sweep Speed	0.1 ms/div to 0.1s/div in 1-2-5 sequence, 23 steps	
Holdoff	Continuously variable for Main sweep up to 10 times normal	
Delay Time Position	Continuously variable to control percentage of display that is devoted to main and delay sweep	
TRIGGERING		
Triggering Modes	AUTO (free run) or NORM, TV-V, TV-H	
Trigger Source	CH 1, CH 2, ALT, EXT, LINE	
Maximum External Trigger Voltage	300 V (DC + AC peak)	
Trigger Coupling	AC 30 Hz to 30 MHz	
	TV H Used for triggering from horizontal sync pulses	
	TV V Used for triggering from vertical sync pulses	
TRIGGER SENSITIVITY		
Coupling	Bandwidth	Int Ext
Auto	100Hz - 40MHz	1.5 div ≥ 0.1Vp-p
Norm	100Hz - 40MHz	1.5 div. ≥ 0.1Vp-p
TV-V	DC - 1kHz	0.5 div ≥ 0.05Vp-p
TV-H	1 kHz - 100kHz	0.5 div ≥ 0.05Vp-p
HORIZONTAL AMPLIFIER (Input through channel 1 input)		
X-Y Mode	Switch selectable using X-Y switch. CH 1: X axis CH 2: Y axis	
Sensitivity	Same as vertical channel 2	
Accuracy	Y-Axis: ± 3%. X-Axis: ± 6%	
Input Impedance	Same as vertical channel 2	
Frequency Response	DC to 1MHz typical (-3 dB), to 6 div horizontal deflection	
X-Y Phase Difference	3° or less at 50 kHz	
Max. Input Voltage	Same as vertical channel 2	
CRT		
Type	Rectangular with internal graticule	
Display Area	8 x 10 div (1 div = 1 cm)	
Accelerating Voltage	2 kV	
Phosphor	P31	
Trace Rotation	Electrical, front panel adjustable	
COMPONENT TESTER		
Components Tested	Resistors, Capacitors, Inductors, and Semiconductors	
Test Voltage	6 V rms maximum (open)	
Test Current	11 mA maximum (shorted)	
Test Frequency	Line Frequency (60 Hz in USA)	
Calibrating Voltage	1 kHz (± 10%) Positive Square Wave, 0.2 V p-p (± 2%)	
Other Specifications		
Within Specified Accuracy	50° to 95° F (10° to 35° C), ≤ 85% RH	
Full Operation	32° to 104° F (0° to 40° C), ≤ 85% RH	
Storage	-4° to 158° F (-20° to +70° C)	
Power Requirements	Approximately 40 W	
All other operating specifications are the same as model 2120A		
Dimensions (WxHxD)	7 x 14.5 x 14.25" (180 x 370 x 440 mm)	
Weight	17.2 lbs (7.8 kg)	
Accessories		Three Year Warranty
SUPPLIED: Instruction Manual, Two PR 33A x1/x10 Probes or equivalent, AC Power Cord, Spare Fuse		
OPTIONAL: PR 32A Demodulator Probe, PR 37AG x1/x10/REF Probe, PR 100A x100 Probe, PR-55 High Voltage x1000 Probe, LC 210A Carrying Case		

30 MHz Analog Oscilloscope



Model 2120B

- Dual or single trace operation
- 5 mV/div sensitivity
- AUTO/NORM triggered sweep operation with AC, TVH, TVV and line coupling
- Calibrated 23 step time base with x 10 magnifier
- Compact low-profile design

Specifications

model

2120B

VERTICAL AMPLIFIERS (Ch 1 and CH 2)

Sensitivity	5 mV/div to 5 V/div, 1 mV/div to 1 V/div at X5
Attenuator	10 steps in 1-2-5 sequence. Vernier control provides full adjustment between steps.
Accuracy	±3%, ±5% at X5
Input Resistance	1 MΩ ±2%
Input Capacitance	25 pF ±10pF
Frequency Response	5 mV to 5 V/div: DC to 30 MHz (-3dB). X5: DC to 10 MHz (-3dB)
Rise Time	12 ns (Overshoot ≤5%)
Operating Modes	CH 1: CH 1, single trace
CH 2	CH 2, single trace
ALT	dual trace, alternating
CHOP	dual trace, chopped
ADD	algebraic sum of CH 1 + CH 2
Polarity Reversal	CH 2 only
Maximum Input Voltage	400 V (DC + AC peak)

SWEEP SYSTEM

Sweep Speed	0.1 μs/div to 2s/div in 1-2-5 sequence, 23 steps Vernier control provides fully adjustable sweep time between steps.
Accuracy	±3%
Sweep Magnification	10x

TRIGGERING

Triggering Modes	AUTO (free run) or NORM, TV-V, TV-H
Trigger Source	CH 1, CH 2, ALT, EXT, LINE
Maximum External	
Trigger Voltage	300 V (DC + AC peak)
Trigger Coupling	AC 30 Hz to 30 MHz
TV H	Used for triggering from horizontal sync pulses
TV V	Used for triggering from vertical sync pulses

TRIGGER SENSITIVITY

Coupling	Bandwidth	Int	Ext
Auto	100 Hz-30 MHz	1.5 div	100 mV
Norm	DC to 30 MHz	1.5 div	100 mV
TV V	20 Hz-1 kHz, .5 div		100 mV
TV H	1 kHz-100 kHz	.5 div	100 mV

HORIZONTAL AMPLIFIER (Input through channel 2 input)

X-Y Mode	Switch selectable using X-Y switch. CH 1: X axis
CH 2	Y axis
Sensitivity	Same as vertical channel 1
Input Impedance	Same as vertical channel 1
Frequency Response	DC to 1 MHz typical (-3 dB)
X-Y Phase Difference	Approximately 3° at 50 kHz
Maximum Input Voltage	Same as vertical channel 1

CRT

Type	Rectangular with internal graticule
Display Area	8 x 10 div (1 div = 1 cm)
Accelerating Voltage	2 kV
Phosphor	P31
Trace Rotation	Electrical, front panel adjustable

Other Specifications

Calibrating Voltage	1 kHz (±10%) Positive Square Wave, 2 V p-p (±3%)
ENVIRONMENT	
Within Specified	
Accuracy	50° to 95°F (10° to 35°C), ≤ 85% RH
Full Operation	32° to 104°F (0° to 40°C), ≤ 85% RH
Storage	-4° to 158°F (-20° to +70°C)
Power Requirements	100/120/220/240 VAC ±10%, 50/60 Hz, approximately 40 W.
Dimensions (WxHxD)	7 x 14.5 x 17.25" (180 x 370 x 440 mm)
Weight	17.2 lbs (7.8 kg)

Accessories

Two Year Warranty

SUPPLIED:	Instruction Manual, Two PR 33A x1/x10 Probes or equivalent, AC Power Cord, Spare Fuse
OPTIONAL:	PR 32A Demodulator Probe, PR 37AG x1/x10/REF. Probe, PR 100A x100 Probe, PR-55 High Voltage x1000 Probe, LC 210A Carrying Case

30 MHz Analog Oscilloscope W/Frequency Counter

Model 2121

- Dual or single trace operation 5 mV/div sensitivity
- AUTO/NORM triggered sweep operation with AC, TVH, TVV and line coupling
- Calibrated 23 step time base with x 10 magnifier
- Compact low-profile design
- Built-in 50 MHz frequency counter



Specifications

		model	
		2121	
VERTICAL AMPLIFIERS (Ch 1 and Ch 2)			
Sensitivity	5 mV/div to 5 V/div, 1 mV/div to 1 V/div at X5		
Attenuator	10 steps in 1-2-5 sequence. Vernier control provides full adjustment between steps.		
Accuracy	± 3%, ± 5% at X5		
Input Resistance	1 MΩ ± 2%		
Input Capacitance	25 pF ± 10pF		
Frequency Response	5 mV to 5 V/div: DC to 30 MHz (-3dB). X5: DC to 10 MHz (-3dB)		
Rise Time	12 ns (Overshoot <5%)		
Operating Modes	CH 1: CH 1, single trace		
CH 2	CH 2, single trace		
ALT	dual trace, alternating		
CHOP	dual trace, chopped		
ADD	algebraic sum of CH 1 + CH 2		
Polarity Reversal	CH 2 only		
Maximum Input Voltage	400 V (DC + AC peak)		
SWEEP SYSTEM			
Sweep Speed	0.1 μs/div to 2s/div in 1-2-5 sequence, 23 steps Vernier control provides fully adjustable sweep time between steps.		
Accuracy	± 3%		
Sweep Magnification	10x		
TRIGGERING			
Triggering Modes	AUTO (free run) or NORM, TV-V, TV-H		
Trigger Source	CH 1, CH 2, ALT, EXT, LINE		
Maximum External Trigger Voltage	300 V (DC + AC peak)		
Trigger Coupling	AC 30 Hz to 30 MHz		
TV H	Used for triggering from horizontal sync pulses		
TV V	Used for triggering from vertical sync pulses		
TRIGGER SENSITIVITY			
Coupling	Bandwidth	Int	Ext
Auto	100 Hz-30 MHz	1.5 div	100 mV
Norm	DC to 30 MHz	1.5 div	100 mV
TV V	20 Hz-1 kHz, .5 div	100 mV	
TV H	1 kHz-100 kHz	.5 div	100 mV
HORIZONTAL AMPLIFIER (Input through channel 2 input)			
X-Y Mode	Switch selectable using X-Y switch. CH 1: X axis		
CH 2	Y axis		
Sensitivity	Same as vertical channel 1		
Input Impedance	Same as vertical channel 1		
Frequency Response	DC to 1 MHz typical (-3 dB)		
X-Y Phase Difference	Approximately 3° at 50 kHz		
Maximum Input Voltage	Same as vertical channel 1		
Frequency Counter			
Display Resolution	Auto select from 0.001Hz to 1kHz depending on the frequency		
Max. Counter Range	0.1Hz to 50MHz		
Max. External Voltage	300V dc + ac peak		
Accuracy	+0.01% + 1 digit or 1/99999 + 1 digit		
Time Base	18,432MHz + 10ppm (23°C±5°C)		
Sensitivity Note:			
1- The Counter must be set at "DC COUPLING" operation then the input signal is less than 10HZ.			
2- The counter is operated by the "Trigger Source" CH1, CH2, or EXT.			
Mode	Range	Sensitivity	
INT	2Hz~40MHz	≥ 1Div	
INT	1Hz~45MHz	≥ 2Div	
INT	0.2Hz~50MHz	≥ 3Div	
EXT	10Hz~50MHz	≥ 200mVrms	
EXT	1Hz~50MHz	≥ 400mVrms	
CRT			
Type	Rectangular with internal graticule		
Display Area	8 x 10 div (1 div = 1 cm)		
Accelerating Voltage	2 kV		
Phosphor	P31		
Trace Rotation	Electrical, front panel adjustable		
Other Specifications			
Calibrating Voltage	1 kHz (± 10%) Positive Square Wave, 2 V p-p (± 3%)		
ENVIRONMENT			
Within Specified			
Accuracy	50° to 95° F (10° to 35° C), ≤ 85% RH		
Full Operation	32° to 104° F (0° to 40° C), ≤ 85% RH		
Storage	-4° to 158° F (-20° to +70° C)		
Power Requirements	100/120/220/240 VAC ± 10%, 50/60 Hz, approximately 40 W.		
Dimensions (WxHxD)	7 x 14.5 x 17.25" (180 x 370 x 440 mm)		
Weight	17.2 lbs (7.8 kg)		
Accessories			
Two Year Warranty			
SUPPLIED:	Instruction Manual, Two PR 33A x1/x10 Probes or equivalent, AC Power Cord, Spare Fuse		
OPTIONAL:	PR 32A Demodulator Probe, PR 37AG x1/x10/REF Probe, PR-100A x100 Probe, PR-55 High Voltage x1000 Probe, LC 210A Carrying Case		

Oscilloscope Accessories

General Purpose Oscilloscope Adapter Kit

CC540



Economical Accessory Kit for General Purpose Oscilloscope Instruments:

Kit Contents:

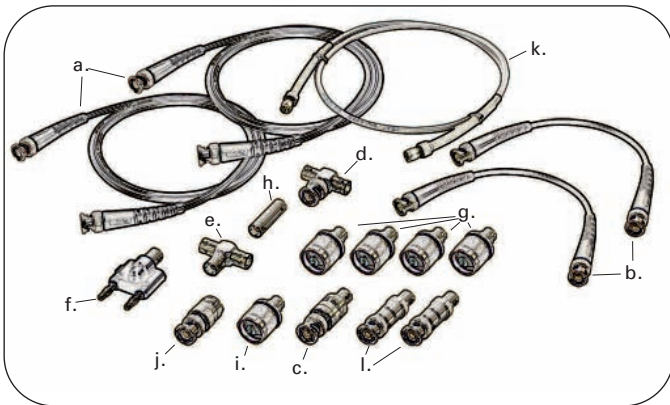

Features:

- BNC & N Type 50Ω Connectors
- Gold plated center contacts
- Storage case

Applications:

- Production Test Stations
- Service & Repair Facilities
- Educational Test Benches
- Calibration Work

Model CC 540 General Purpose Oscilloscope Adapter Kit provides a range of BNC and N Type coaxial interconnection for general purpose oscilloscope test interconnections. All components feature standard BNC or N type connectors with 50Ω impedance to ensure accurate measurements. The kit is provided in a convenient foam lined storage case for easy selection and use.

Item.	Description	Qty.	Frequency Range	VSWR Max.
a.	BNC male Cable, 100cm (40")	2	DC - 1 GHz	1.20:1 @ 1 GHz
b.	BNC male Cable, 25cm (10")	2	DC - 1 GHz	1.20:1 @ 1 GHz
c.	BNC Feed-Thru Terminator, 2W	1	DC - 1 GHz	1.35:1 @ 1 GHz
d.	BNC Tee, female-male-female	1	DC - 4 GHz	N/A
e.	BNC Tee, female-female-female	1	DC - 4 GHz	N/A
f.	BNC female to Double Banana Plugs	1	N/A	N/A
g.	BNC female to N Type male	4	DC - 4 GHz	1.30:1 @ 4 GHz
h.	BNC female-female	1	DC - 4 GHz	1.30:1 @ 4 GHz
i.	N Type male to SMA female	1	DC - 8 GHz	1.30:1 @ 8 GHz
j.	BNC male to N Type female	1	DC - 4 GHz	1.30:1 @ 4 GHz
k.	SMA male Cable, 100cm (40")	1	DC - 6 GHz	1.20:1 @ 6 GHz
l.	BNC Attenuator, 20dB (10x) 2W	2	DC - 4 GHz	1.25:1 @ 4 GHz

Special BNC Cable Assemblies

Models CC-21 & CC-130

Standard BNC to Alligator clips or Sheathed Stacking Plugs. Model CC-21, Black, molded strain release boots provides for long-life. RG58C/U cable with 50Ω impedance. Model CC-130 with fully insulated BNC male to Sheathed Stacking 4mm plugs. Meets IEC61010 safety standards. Includes highly flexible RG58 Type cable in 2.0 meter length. Color: Black.



Demodulator Probe

Model PR 32A

All purpose demodulator probe, usable with most oscilloscopes. Features light weight design and 48" (1.2m) coaxial cable.



Features	model	
	CC-21	CC-130
Impedance	50Ω	50Ω
Cable	RG58 C/U	RG58 Type
Connectors	BNC m to Alligator Clips	Insulated BNC male to 4mmPlugs
Voltage	500Vrms	150V CAT II
VSWR	≤ 1.2	≤ 1.2
Cable Length	40" (1.0m)	80" (2.0m)

Features	model
	PR-32A
Bandwidth	100kHz-650MHz
Accuracy	± 3dB
Voltage	200V
HF Voltage	50Veff
Actuating Voltage	250mV
Input Capacitance	5pF
Cable Length	48" (1.2m)
Body Color	Black

Oscilloscope Accessories

General Purpose Probes

B+K Precision offers a complete line of oscilloscope probes to enhance the versatility of your unit. Both fixed attenuation and switchable from 100 to 250 MHz are available. Each probe includes a full accessory kit with a Sprung Hook, Replacement Tip and BNC Adapter.

■ All models compliant to IEC61010-031



PR-33A



PR-100A



PR-37AG



PR-2000

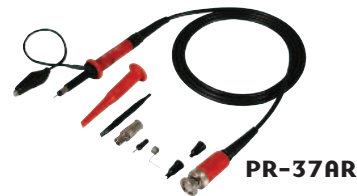

PR-37AR

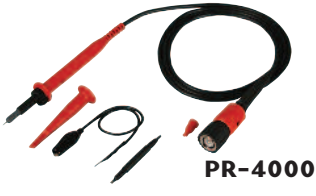

PR-4000



PR-150



PR-55

See page 140 through 151 for additional oscilloscope and general purpose accessories



Active Differential Probe

Model PR-60

Allows safe and accurate floating measurements with your standard analog or digital oscilloscope. Switchable between x10 and x100 attenuation. Unit includes black and red probes and protective rubber jacket.

Features

	model PR-60
Bandwidth	25MHz (-3dB)
Attenuation Ratio	x10/x100
Accuracy	±2%
Rise Time	14 ns
Input Impedance	4MΩ/10pF each side to ground
Input Voltage	
Max. Differential	±700V (DC+Peak AC)
Max. Common Mode	±700V (DC+Peak AC)
Output Voltage	
Max. Amplitude	±7V (into 2kΩ load)
Offset (Typical)	≤ ±5mV, -10° to 40° C
Noise (Typical)	1.5 to 2mV
Source Impedance	1Ω @ 1kHz 8Ω @ 1MHz
CMRR	
50Hz	86 dB
20kHz	66 dB
200kHz	56 dB
Probes	Sprung Hooks (B/R)
Length of Input Lines	18" (45cm)
Operating Temperature	14° to 104°F (-10° to 40° C)
Power Requirements	4 x AA Cells
Certification	IEC61010-1 CATIII

Specifications

	PR 33A	PR 37AG	PR 37AR	PR 150	PR 100A	PR 2000	PR 4000	models PR-55
Bandwidth (MHz)	15/90	6/150	6/150	25/150	250	150	100	50
Attenuation	x1/x10	x1/x10/REF	x1/x10/REF	x1/x10	x100	x100	x100	x1000
Input Impedance								
R(MΩ)	1/10	1/10	1/10	1/10	100	50	50	100
C(pF)	46/16	100/15	100/15	45/12	6.5	5	5	1
Voltage (VDC+ACmax)	600	600	600	300	1,200	2,000	4,000	10,000
Compensation (pF)	10..35	10..35	10..35	10..30	10..35	10..30	10..30	10..30
Cable Length	48" (1.2m)	48" (1.2m)	48" (1.2m)	48" (1.2m)	48" (1.2m)	48" (1.2m)	48" (1.2m)	80" (2.0m)
Body Color	Black	Gray	Red	LtGray	Black	Red	Red	Yellow

Handheld Spectrum Analyzers 3.3GHz, 8.5GHz



2658

Handheld Spectrum Analyzers 3.3GHz & 8.5GHz

Models 2650, 2652 & 2658

B+K Precision's 2650 series handheld spectrum analyzers are small and exceptionally light weight - yet they deliver performance and features comparable to full size bench spectrum analyzers. They are the most cost effective spectrum analyzers for quick and precise signal investigations, especially away from the bench. With their ease of use, great performance, and broad functionality, they are ideal tools for engineers and technicians who perform field measurements in the 50kHz to 3.3GHz range (models 2650/2652) or 50kHz to 8.5GHz range (model 2658).

Applications

- Installation, maintenance, and trouble shooting of wireless communication systems such as W-CDMA/CDMA, GSM, WLAN and Bluetooth
- Frequency response measurements of passive components such as RF cables, filters, and attenuators (model 2652 only)
- Detection of signal interference and undesired emissions
- TV and broadcasting
- Antenna alignment
- EMI compliance (E & H field measurements with optional accessories)

Superb performance improves your productivity

Advanced synthesizer-based design enables the 2650 series to provide you with an accurate and detailed picture of the spectrum you are investigating.

- Single sideband phase noise – 90 dBc @ 100kHz offset
- Fast sweep speed (minimum 10 ms)
- DANL (displayed average noise level) of -110 dBm

Tracking generator (model 2652 only)

The 2652 is a 2650 with a tracking generator added. The 2652 can be used to rapidly determine transmission characteristics of two-port RF devices.

Specifications of Tracking Generator

Frequency range	5MHz to 3.3GHz
Output Level	-10dBm ± 1dB @ 1GHz (output level is fixed)
Output flatness	± 1.5dB
Output impedance	50Ω
VSWR	<2.0
Output connector	SMA (I)

Tracking generators are ideal for tuning filters, determining the usable frequency range of amplifiers and attenuators and aligning receiver IF stages.

The tracking generator's output frequency is the same as the frequency the spectrum analyzer is tuned to. This lets you see the amplitude response of a circuit on the spectrum analyzer screen.



Input (analyzer)

Output (tracking generator)

Handheld Spectrum Analyzers 3.3GHz, 8.5GHz

Applications (Model 2652)

■ Frequency response of a filter

Measure the frequency response of a passive component, e.g a filter, over the 2652's full range of 5MHz to 3.3GHz.

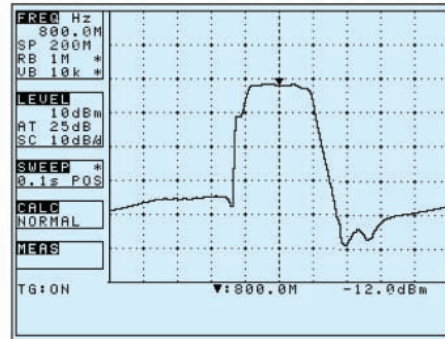
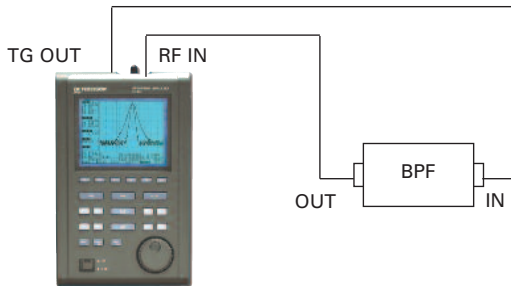

■ Gain characteristics of an amplifier

Characterize the frequency response of an active circuit such as an amplifier.

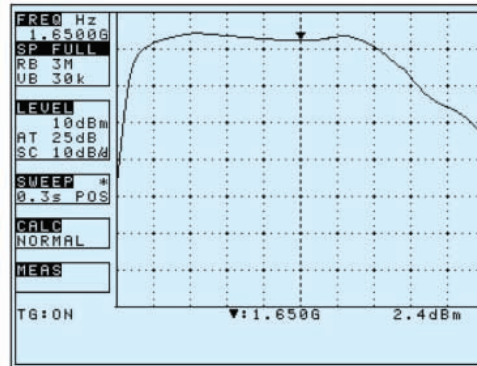
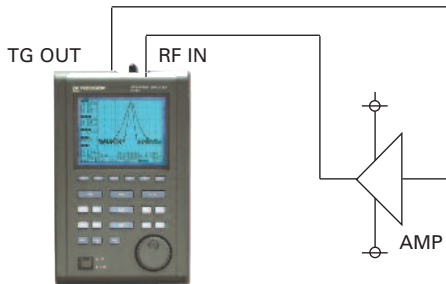

■ Return loss measurement

Measure the return loss of an electric component or circuit with a VSWR bridge configured as indicated in the figure below

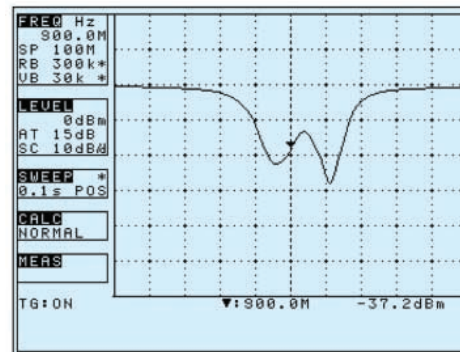
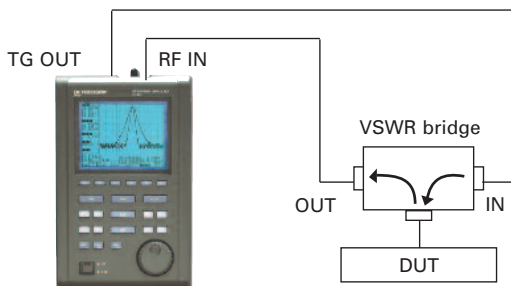

Handheld Spectrum Analyzers 3.3GHz, 8.5GHz

Easy to use

The 2650 handheld analyzers are straightforward to operate and provide many functions to facilitate quick and easy measurements.

The "One button Auto Tune" function automatically scans the full frequency range, detects and centers the maximum signal and automatically configures optimum values for RBW, VBW, sweep time and reference level.

Frequency, span, and amplitude are easily configured. Marker and peak search functions enable rapid numerical measurements.

Marker Function

Two different modes are available for marker measurements:

- Normal marker mode measures the frequency and level of the marked point
- Delta marker mode measures the frequency and level differences between two markers

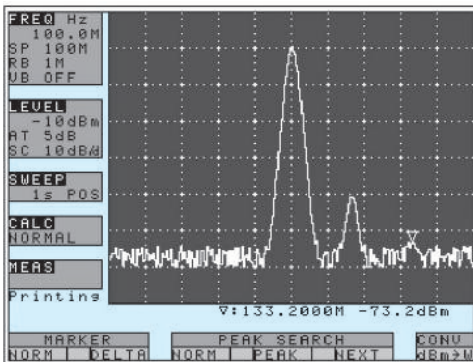

Peak Function

Two different modes are available for peak search:

- Normal peak search mode searches for the highest level on the screen. In this mode, you can also use the NEXT button to locate the marker on the next smaller peak.
- In-zone peak search mode searches for the peak level in the range specified by the center value and width.

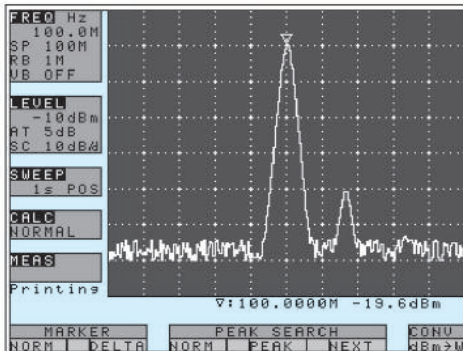

Versatile measurement and calculation functions

Measurement functions Channel Power, Adjacent channel power, Occupied bandwidth

Channel power measurement

Allows you to measure both power or noise in a user specified bandwidth.

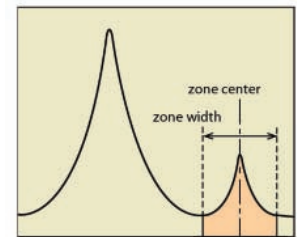

Adjacent channel power measurement

Measure the ratio of power leakage (from the wanted signal) into adjacent channels.

Center frequency, adjacent channel bandwidth and offset between main carrier and adjacent channels can be set.

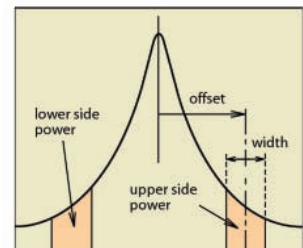

Additionally, the user can select from any of the following three measurement methods, based on the carrier wave definition: Total power, Peak (reference level) and in-band.

Handheld Spectrum Analyzers 3.3GHz, 8.5GHz

■ Calculation functions: Min/Max hold, average and over write

Average

The analyzer continuously sweeps, then calculates and displays the average value over the total number of sweeps. The number of sweeps can be set between 2 and 256. Averaging is useful for detecting signals buried in the noise floor.

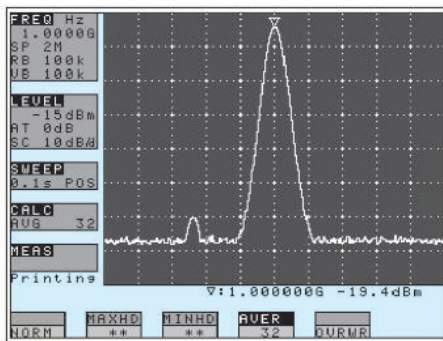

Over Write

The results of each consecutive sweep are displayed rather than clearing the screen after each sweep. This lets you observe the long term variations of a signal.

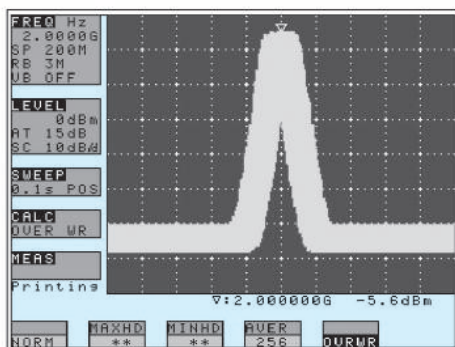

■ Electric field strength measurement

(with optional dipole antennas) for the detection of EMI (electromagnetic interference) trouble spots

■ Magnetic field strength measurement

Using the optional PR 26M magnetic field probe, precisely measure the magnetic field distributions on an IC or a printed circuit board

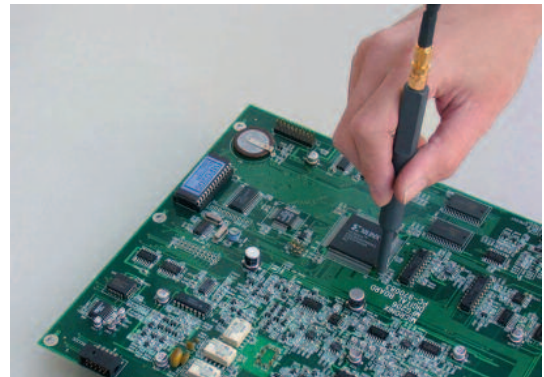

Easily document your measurements

Intuitive Windows 98/NT/2000/XP compatible Software for frequency spectrum download and additional analysis and report generation (option AK 2650).

- Continuously sweep and transfer trace data to the PC.
- Store trace data in text or csv (comma separated values) format. Capture 1001 spectrum data points (4 times the number of display dots) for more detailed analysis
- Save the present screen to bitmap or to the clipboard
- Control all instrument settings from the PC
- Generate a hard copy of the display by connecting the optional printer PT 2650 directly to the 2650.

Specifications

models

2650, 2652

2658

Frequency section	
Frequency range	50kHz to 3.3GHz
Center frequency	50kHz to 8.5GHz
Resolution	100kHz (Set with rotary encoder, numeric or function key)
Accuracy	within $\pm(30 + 20T)$ kHz ± 1 dot @ frequency span: 200kHz to 10MHz, RBW: 30kHz, $23 \pm 5^\circ\text{C}$ within $\pm(100 + 700T)$ kHz ± 1 dot @ frequency span: 20MHz to 3.3GHz, RBW: 100kHz, $23 \pm 5^\circ\text{C}$ 20MHz to 8.5GHz (2658) T: Sweep time(s)
RBW frequency error	within $\pm 6\%$ of RBW (@ RBW: 3kHz to 30kHz) within $\pm 30\%$ of RBW (@ RBW: 100kHz to 3MHz)
Frequency span	
Range	0Hz (zero span), 200kHz to 2GHz (1-2-5 steps) and 3.3GHz (Full span)
Accuracy	within $\pm 3\% \pm 20T$ kHz ± 1 dot @frequency span: 200kHz to 10MHz, $23 \pm 5^\circ\text{C}$ within $\pm 3\% \pm 200T$ kHz ± 1 dot @frequency span: 20MHz to 3.3GHz, $23 \pm 5^\circ\text{C}$ 20MHz to 8.5GHz (2658) T: Sweep time(s)
Display resolution (horizontal)	Frequency span/250 The unit displays 251 horizontal dots but stores 1001 trace data points internally which can be captured via RS232C interface
Resolution bandwidth (-3dB bandwidth)	
Range	3kHz to 3MHz (1-3 sequence) and AUTO
Accuracy	within $\pm 20\%$
Shape Factor	1:12 (typical, 3dB:60dB)
Video bandwidth	100Hz to 1MHz (1-3 sequence), AUTO
SSB phase noise	-90dBc/Hz (typical) @100kHz offset, RBW: 3kHz, VBW: 100Hz, Sweep time: 0.3s
Spurious response	less than -60dBc
Harmonics	less than -40dBc @100MHz to 3.3GHz (2650, 2652) less than -40dBc @100MHz to 8.5GHz (2658)
Amplitude section	
Reference level	
Range	+10 to -60dBm (1dB step)
Accuracy	within $\pm 0.8\text{dB} \pm 1$ dot @center frequency: 100MHz, RBW: 3MHz, VBW: 1MHz, ATT: 0dB, $23 \pm 5^\circ\text{C}$
Unit	dBm, dBV, dBmV, dB μ V, dB μ V/m, dB μ A/m (dB μ V/m and dB μ A/m are available for certain measurement functions)
Average noise level	-110dBm (typical) @center frequency: 100MHz (2650, 2652), 1GHz (2658) RBW: 3kHz, VBW: 100Hz
Frequency response	Within $\pm 2.0\text{dB} \pm 1$ dot @50kHz to 100MHz Within $\pm 1.0\text{dB} \pm 1$ dot @100MHz to 3.3GHz
Input impedance	50 Ω
Input VSWR	< 2.0
Input attenuator	
Operating range	0 to 25dB (1dB step), coupled with reference level
Switching error	within $\pm 0.6\text{dB}$ @100MHz
RBW switching error	within $\pm 0.6\text{dB}$
Display resolution (vertical)	200 dots
Display scale	
Scale	10dB/div, 2dB/div

Accuracy	within $\pm 0.8\text{dB}/10\text{dB} \pm 1$ dot within $\pm 0.2\text{dB}/2\text{dB} \pm 1$ dot within $\pm 1.6\text{dB}/70\text{dB} \pm 1$ dot
Input damage level	+23dBm (CW average power), 25VDC
Sweep section	
Sweep time	
Range (1-3 step)	10ms - 30s and AUTO @frequency span: 0 to 2GHz 30ms - 30s and AUTO @full span
Accuracy	within $\pm 0.1\% \pm 1$ dot @frequency span: 0 to 2GHz within $\pm 1.5\% \pm 1$ dot @frequency span: full span
	10ms - 30s and AUTO @frequency span: 0 to 2GHz 30ms - 30s and AUTO @freq. span: 5GHz
	within $\pm 0.1\% \pm 1$ dot @frequency span: 0 to 5GHz within $\pm 2.5\% \pm 1$ dot @frequency span: full span
Trigger mode	AUTO (frequency span: zero span)
Detection mode	Positive peak, Negative peak, Sample
Measurement and Calculation Functions	
Marker	NORM: displays frequency (7 digits max) and level (4 digits max) at marker point. DELTA: displays Δ (Frequency) and Δ dBx (level).
Peak search	NORM: searches peak point within 10div (full freq. range). This mode also supports NEXT peak (up to 10). ZONE: searches peak point within a zone defined by center and width.
Calculations	NORM, MAX HOLD, MIN HOLD, AVERAGE, OVER WRITE MAX/MIN HOLD: 2 to 1024 AVERAGE: 2 to 256
Measurements	Measure Channel power, Adjacent channel leakage power, Occupied frequency bandwidth, Electric field strength (requires antenna), Magnetic field strength (requires magnetic field probe).
AUTO tuning	Automatically scans the full bandwidth, detects the maximum level spectrum and centers it onscreen. Automatically adjusts reference level, RBW, VBW and sweep time to optimum values.
General	
Input connector	SMA (I)
Save/Load	
Save	Saves 100 traces and 100 setups
Load	Loads 1 trace and 1 setup
Communication	
Interface	RS-232C
Baud rate	2,400 to 38,400bps
Hard copy	Allows direct hard copy with optional printer.
Display	
Display	LCD
Backlight	CFL backlight
Resolution	320 (H) x 240 (V) dots
Power source	
Battery	Ni-MH battery
Operating time	approx. 110 min with the backlight turned off (Battery fully charged)
External DC source	DC jack, +4.75 to +5.25VDC / 4A
Environmental and size	
Operating temperature	0 to 50°C (Guaranteed at $23 \pm 10^\circ\text{C}$, without soft carrying case)
Operating humidity	less than 40°C/80%RH (Guaranteed at less than 33°C/70%RH, without soft carrying case)
Storage temperature	-20 to 60°C, less than 60°C/70%RH
Dimensions	6.38(W) x 2.76(H) x 10.25(D) inch 162 (W) x 70 (H) x 260 (D) mm (excluding projections and stand)
Weight	4 lbs (1.8kg) including battery
Accessories	
Accessories Included	Instruction Manual, NI-MH battery BP2650, AC-Adapter BC 2650, Soft carrying case, Accessory Pouch, Fuse
Optional	PC Software AK2650 w. RS232 cable, Printer PT2650, magnetic field probe PR 26M, Dipole Antennas AN301-AN306

Two Year Warranty

Spectrum Analyzer



1.05 GHz Spectrum Analyzer w/Tracking Generator

Model 2630

A great tool for professionals in the cable TV industry as well as in the telecommunication field. It is a value packed service tool for signals up to 1.05GHz. Model 2630 is suitable for pre-compliance testing during development prior to third party testing.

An optional near-field sniffer probe set (PR 261) can be used to locate cable and PC board emission "hot spots" and evaluate EMC problems at the breadboard and prototype level. The spectrum analyzer/sniffer probe combination is an excellent solution for RF leakage/radiation investigation, CATV/MATV system troubleshooting, cellular telephone/pocket pager test and EMI diagnostics.

Convenient carrying case is available.

Performance

- 150kHz to 1.05GHz (1050MHz)
- Dynamic Range 80dB (113dB with attenuation)
- AM & FM demodulator included
- 20 and 400 kHz resolution bandwidth
- 150kHz/hour stability
- Built-in tracking generator

Applications

- Test cable TV levels and frequency response
- Test master antenna TV systems
- Measure communications transmitter spurious radiation
- Locate sources of EMI
- Measure unwanted RF radiation

Specifications

	2630 model
Frequency	1.05GHz (1050MHz)
Frequency range	0.15MHz to 1.05GHz (1050MHz) (-3dB)
Center frequency display accuracy	± 100kHz
Marker accuracy	± (0.1% span + 100kHz)
Frequency display resolution	100kHz (4 digit LED)
Frequency scanwidth	100kHz/div to 100MHz/div in 1-2-5 steps and 0Hz/div (Zero Scan)
Frequency scanwidth accuracy	± 10%
Frequency stability	Drift: < 150kHz/hour
IF Bandwidth (-3dB)	Resolution: 800kHz and 20kHz. Video-Filter on: 4kHz
Sweep rate	43Hz
AMPLITUDE	
Amplitude range	-100dBm to +13dBm
Screen display range	80dB (10dB/div.)
Reference level	-27dBm to +13dBm (in 10dB steps)
Reference level accuracy	± 2dB
Average noise level	-99dBm (12.5kHz BW)
Second and third harmonic	< -75dBc
Third order intermod.	-70dBc (two signals > 3MHz apart)
Log scale fidelity	± 2dB (without attn.) 250MHz
IF gain	10dB adjustment range
INPUT	
Input impedance	50Ω
Input connector	BNC
Input attenuator	0 to 40 dB (4 x 10dB steps)
Input attenuator accuracy	± 1dB
Maximum input level	+10dBm, ± 25VDC (with 0dB attenuation); +20dBm (with 40dB attenuation)
TRACKING GENERATOR	
Output level range	-50dBm to +1dBm (in 10dB steps and var.)
Output attenuator	0 to 40dB (4 x 10dB steps)
Output attenuator accuracy	± 1dB
Output impedance	50Ω (BNC)
Frequency range	0.15MHz to 1050MHz
Frequency response	± 1.5dB
Radio Frequency Interference (RFI)	< 20dBc
GENERAL	
Operating temperature	50° to 122°F (10°C to 50°C)
Display	CRT, 6 inch, 8 x 10 div. internal graticule
Trace rotation	Adjustable on front panel
Line voltage	90-260Vac, 50/60 Hz (125V, 400Hz)
Power consumption	approx. 20W
Max. ambient temperature	14° to 104°F (-10°C to +40°C)
Protective system	Safety Class I (IEC 348)
Weight	approx. 13.2 lbs. (6.0 kg)
Dimensions (HxWxD)	4.9 x 11.2 x 15" (125 x 285 x 380mm)

Accessories

One Year Warranty

SUPPLIED: Instruction Manual, Power Cord

OPTIONAL: AT 21 Telescoping Antenna, PR 261 Near-field

Sniffer Probe, ZTF1 50Ω to 75Ω , Adapter, LC 210A Carrying Case

Spectrum Analyzer Accessories

Standard Accessories (2650, 2652 & 2658)

- **AC Adapter**
BC 2650



- **Ni-MH battery**
BP 2650



- **Soft carrying case**
LC 2650



- **Accessory pouch**



- **Fuse**

- **Operating manual**

Optional accessories (2650, 2652 & 2658)

- **Dipole antenna**

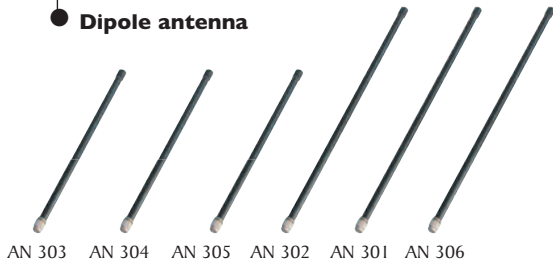

- **Magnetic field**
PR 26M



- **Coaxial adapter**
CT 2701



- **Spectrum Analyzer Coaxial Cable & Adapter Kit**

CC 265
The kit is a replacement for B&K Precision model numbers: CC 301, CC 302, CC 303, CC 304, CC 305, CC 306 & CC 307
Please see page ___ for more details



- **PC software**
AK 2650



- **Roll paper for print-**
PX 2650



- **Printer**
PT 2650



(with AC adapter 4 pcs of batteries a roll paper)

Specifications for optional accessories

■ Magnetic Field Probe Model PR 26M

Items	Specifications
Frequency Range	10MHz to 3GHz
Space Resolution	approx. 0.25mm (depending on objects)
Dimensions	Outside: 12Ø x 135mm
	Probe tip: 2mm (W) x 1mm (T)
Connector	SMA(P)

■ Printer

Items	Specifications
Printing method	Thermal serial dot method
Paper	80mm width thermal paper
Power source	internal: alkaline battery (4pcs)
	External: DC6V/1.5A
Dimensions	(WxHxD) 134 x 58 x 180mm
Weight	approx. 550g (mainframe only)

■ Dipole Antennas (antenna gain and VSWR are specified at a center of frequency range)

Items	AN 301	AN 302	AN 303	AN 304	AN 305	AN 306
Frequency Range	0.8 to 1GHz	1.25 to 1.65GHz	1.7GHz to 2.2GHz	2.25GHz to 2.65GHz	390 to 410MHz	4.7GHz to 6.2GHz
Antenna Gain	> 1dBi	> 1dBi	> 1dBi	> 1dBi	> 1dBi	> 1dBi
VSWR	< 1.5	< 1.5	< 1.5	< 1.5	< 1.5	< 1.5
Dimensions	7.5Ø x 250mm	7.5Ø x 250mm	7.5Ø x 250mm	7.5Ø x 250mm	7.5Ø x 250mm	7.5Ø x 250mm
Weight (approx.)	20g	20g	20g	20g	20g	20g

Spectrum Analyzer Kit

Spectrum Analyzer Coaxial Cable & Adapter Kit

CC265

The kit is a replacement for B&K Precision model numbers: CC 301, CC 302, CC 303, CC 304, CC 305, CC 306 & CC 307



Features:

- High frequency SMA cable assembly
- BNC & N type 50Ω Adapters
- Gold plated center conductors
- Storage case

Applications:

- R&D laboratories
- Production test stations
- Service & repair facilities
- Educational test benches
- Calibration work

This convenient kit provides the most popular and useful coaxial accessories to inter-connect B&K Precision's 2650 series Spectrum Analyzers.

Included is a high-performance 24" (60 cm) SMA male to male cable assembly rated at 50Ω and 18 GHz. It features gold plated SMA male connectors and FEP jacketed coaxial cable. To interconnect with other instruments and devices, the kit also includes four (4) coaxial adapters, all featuring SMA females for use with the cable assembly: BNC male, BNC female, N type male and N type female. The BNC to SMA adapters are rated to 4 GHz while the N type to SMA adapters are rated to 11 GHz. Both types have 50Ω impedance. The Kit is supplied in a carrying case for protection and convenience.

Kit Contents:

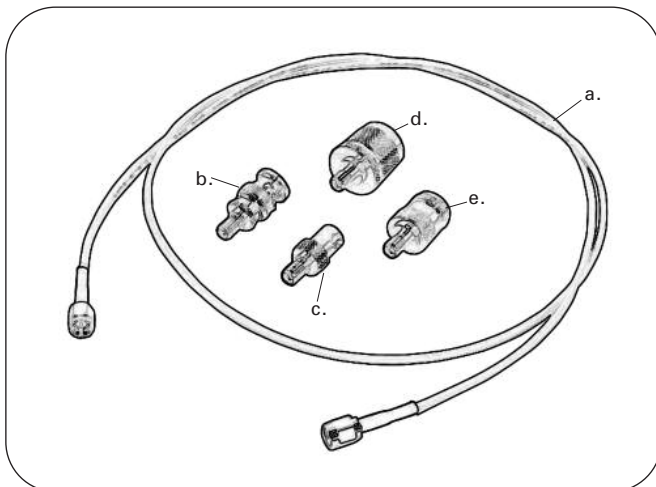

Itn.	Description	Qty.	Frequency	VSWR Max.
a.	SMA male Cable, 60cm (24")	1	DC – 18 GHz	1.3:1 @ 18 GHz
b.	BNC male to SMA female	1	DC – 4 GHz	1.30:1 @ 4 GHz
c.	BNC female to SMA female	1	DC – 4 GHz	1.30:1 @ 4 GHz
d.	N type male to SMA female	1	DC – 11 GHz	1.30:1 @ 11 GHz
e.	N type female to SMA female	1	DC – 11 GHz	1.30:1 @ 11 GHz

Spectrum Analyzer Kit

Deluxe Spectrum Analyzer Accessory Kit

CC560



Features:

- Convenient interconnection kit
- BNC & N Type 50Ω Connectors
- Instrument Grade Adapters
- Gold plated center contacts
- Storage case

Applications:

- Production Test Stations
- R&D Labs
- Service & Repair Facilities
- Calibration Services
- RF Field Testing

Deluxe Accessory Kit for RF & Microwave Spectrum Analyzers:

Model CC560 Deluxe Spectrum Analyzer Kit provides a complete range of high quality coaxial adapters and cables for Spectrum Analyzer applications. This kit contains just the right mix of high performance accessories for every day testing as well as for instrument performance verification and calibration work.

Selected adapters are Deluxe BNC or N Type products. These high quality components easily meet or exceed the instrument manufacturer's recommended accessories specifications. All kit components feature precision machined interfaces, 50Ω impedance and low VSWR to ensure accurate and repeatable measurements.

The kit is provided in a convenient foamed case for easy component selection and storage.

Kit Contents:

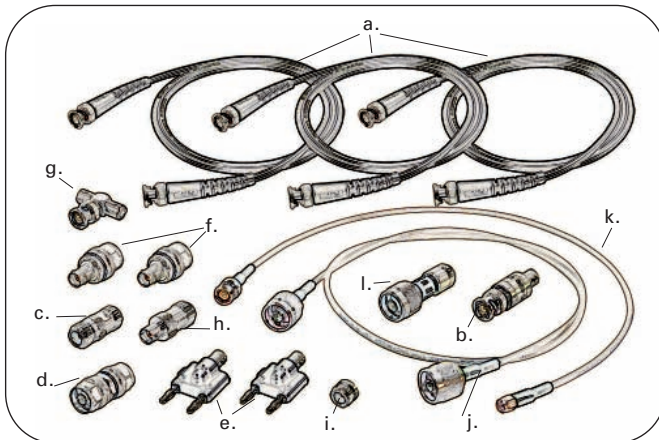

Itm.	Description	Qty.	Frequency Range	VSWR Max.
a.	BNC Cable Assembly, 120cm (48")	3	DC - 1 GHz	1.20:1 @ 1 GHz
b.	BNC Feed-Thru Terminator, 2W	1	DC - 1 GHz	1.20:1 @ 1 GHz
c.	N Type female to female	1	DC - 11 GHz	1.05:1 @ 2 GHz
d.	N Type male to male	1	DC - 11 GHz	1.04:1 @ 2 GHz
e.	BNC female to Double Banana Plugs	2	N/A	N/A
f.	BNC female to N Type male	2	DC - 10 GHz	1.12:1 @ 1 GHz
g.	BNC Tee female to male to female	1	DC - 10 GHz	N/A
h.	BNC female to N Type female	1	DC - 10 GHz	1.04:1 @ 1 GHz
i.	N Type female to SMA female	1	DC - 11 GHz	1.06:1 @ 2 GHz
j.	N Type male Cable, 100cm (40")	1	DC - 18 GHz	1.20:1 @ 10 GHz
k.	BNC to SMA male Cable, 60cm (24")	1	DC - 6 GHz	1.20:1 @ 6 GHz
l.	N Type Attenuator, 10dB (3.2x) 2W	1	DC - 12.4 GHz	1.25:1 @ 12.4 GHz

Highspeed Programmable Attenuators



Highspeed Programmable Attenuators for RF and Microwave Applications

Models 6010, 6011, 6012 & 6013

The 6010 series represents a new concept of programmable RF and microwave attenuators offering performance and features not found in traditional attenuators. The attenuators can operate in an attenuation range of 80dB, minimum step size of 0.05 dB, switching speed of up to 2us and cover a wide frequency range of 1.5 – 13.5 GHz. Attenuation values can be set manually from the front panel, programmed via the standard GPIB or RS232 interface or created with the included Windows based Software by generating an attenuation profile and transferring it to the instrument's internal memory. The outstanding performance, flexibility and ease of use of the 6010 series make them an ideal tool for a many applications in the field of wireless communications such as CDMA, GSM, wireless LAN, Bluetooth, ETC (Electronic Toll Collection) and RFID.

Applications

- Simulation of handover/handoff scenarios
- Simulation of fading scenarios and path degradation due to obstacles
- Receiver sensitivity test (verification of automatic gain control)

Features

- Four models covering a wide range of frequencies:

Model	Frequency Range
6010	1.5 to 4.5GHz
6011	3.0 to 9.0GHz
6012	4.5 to 13.5GHz
6013	1.95 to 5.85GHz

- PC Software for creation of arbitrary attenuation profiles and download to the attenuator's internal program memory (included)
- Program mode operation offering:
 - 128k word built-in program memory suitable for simulation of complex air interface scenarios
 - Clock frequency of up to 0.5MHz
 - Flexible program execution in FREE, BURST or GATE mode
 - Setting of Pause time in number of clock cycles or absolute time
- 80dB attenuation range (all 4 models)
- Minimum step size of 0.05dB
- GPIB/IEEE-488 and RS-232 interfaces are standard

Highspeed Programmable Attenuators

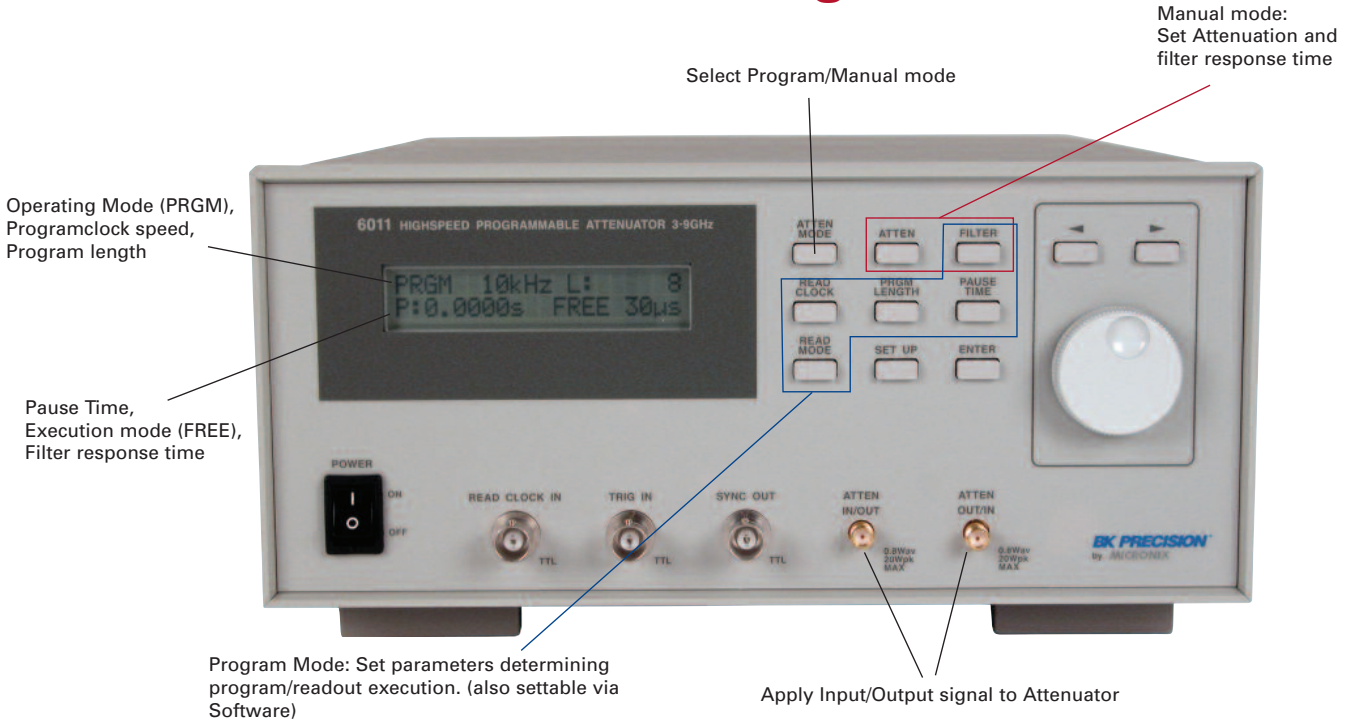

Flexible operating modes

The 6010 series offers several ways to create and output attenuation data. Attenuation levels can be set manually using the front panel keys or by executing a program resident in internal memory.

Manual mode

Use the rotary encoder to set the attenuation level and filter response time. Alternatively, you can also set the attenuation level by sending a remote command via RS-232C or GPIB interface.

```

MANUAL    23.45 dB
           30 μs
    
```

Program mode

In this mode, attenuation levels are controlled by the attenuation profile resident in program memory. The 5 parameters Readout Clock, Program Length, Pause Time, Readout Mode and Filter Setting control the execution of the attenuation program.

```

PRGM    10kHz L: 131072
P: 6.5535s  FREE 30 μs
    
```

The program readout period is the period from address 0 of the program memory to address n, which is defined by the program length. The program length can be set between 8 and 131072 words in one word increments. When program execution reaches address n, the attenuation data at address n is held for the duration of Pause Time, after which readout of the program memory is repeated, starting again at address 0. The Pause Time is defined by number of readout clock cycles or as a time value.

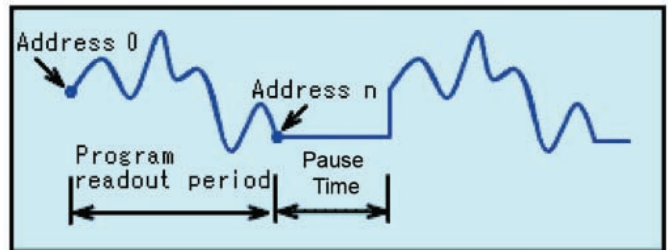

Highspeed Programmable Attenuators

Program execution control modes

Readout of attenuation data is controlled by parameters Free, Burst and Gate. In FREE run mode, attenuation data (readout period) followed by a Pause Time period is clocked out continuously without the need of external trigger signals. In Burst mode, each rising edge of the trigger signal applied to TRIG IN triggers execution of the program memory. Pause Time does not apply. In Gate mode, one set of the readout period and Pause time intervals is repeated while the trigger signal is TTL high.

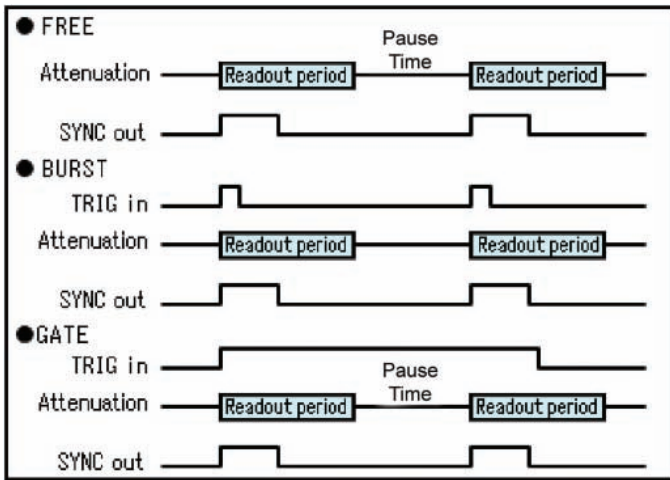

Filter setting

Use the built-in filter to reduce switching transients. To set the filter response time appropriately in relationship to the readout clock, a value of 1/2 to 1/8 of the clock period is recommended.

Application: Simulate signal path degradation of wireless communication link

Wireless communication equipment (e.g. CDMA, GSM, WLAN, Bluetooth) is subject to variations of received signal power due to obstacles and fading effects as the radio wave propagates through space. The 6010 series can be used to simulate these effects by generating a dynamic transmit power pattern with the included software tool. The test could be performed by placing the UUT (Unit Under Test) in one of B+K Precision's shielded RF boxes.

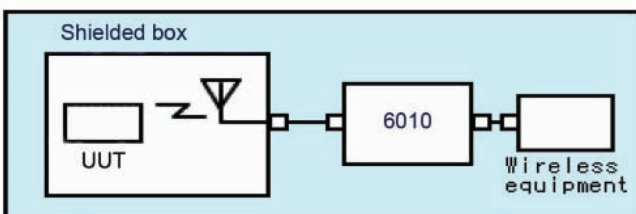

Intuitive software for generating attenuation profiles

The 6010 series includes Windows® based software allowing users to quickly create and edit attenuation profiles and transfer the attenuation data points via RS-232 interface to the instrument's internal memory. Parameters Readout Clock, Program Length, Pause Time, Readout Mode and Filter response time are set by the Software but can also be modified from the front panel after attenuation data was downloaded.

Generate and edit attenuation profiles in many ways

- Enter standard waveform: Select one of the standard waveform types sine, triangle, square, ramp, sin x/x, exponential rise/fall and DC.
- Draw attenuation profiles freehand
- Enter attenuation data point by point and connect with straight line input
- Math operations: Edit a waveform by applying one of the following arithmetic operations to an existing waveform: addition, subtraction, clipping, absolute, mirror (reflection about time or attenuation axis), smoothing, resize and offset
- Edit waveforms using CUT, COPY, PASTE and UNDO.

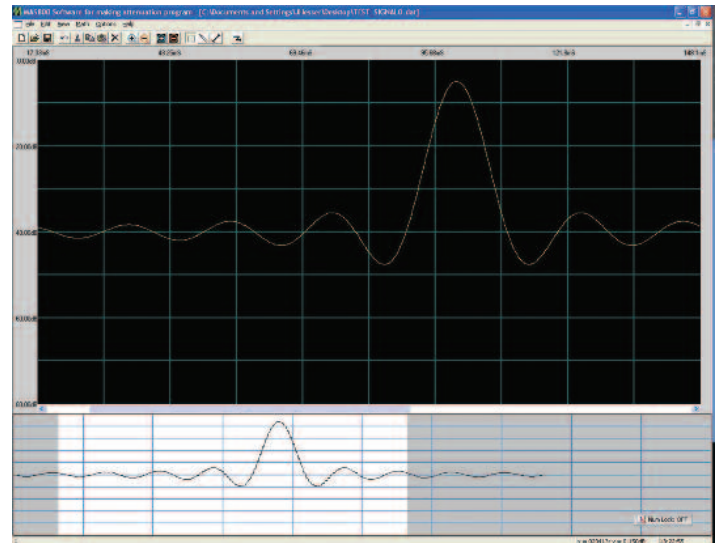

Highspeed Programmable Attenuators

Specifications					models
	6010	6011	6012	6013	
Frequency range	1.5 to 4.5GHz	3.0 to 9.0 GHz	4.5 to 13.5GHz	1.95 to 5.85GHz	
VSWR	< 1.5 @ 2 to 4GHz < 2.0 @ 1.5 to 4.5GHz	< 1.7 @ 4 to 8GHz < 2.2 @ 3 to 9GHz	< 1.8 @ 6 to 12GHz < 2.2 @ 4.5 to 13.5GHz	< 1.6 @ 2.6 to 5.2GHz < 2.1 @ 1.95 to 5.85GHz	
insertion loss (0dB setting)	< 2.3dB @ 2 to 4GHz < 2.6dB @ 1.5 to 4.5GHz	< 3.0dB @ 4 to 8GHz < 3.3dB @ 3 to 9GHz	< 3.5dB @ 6 to 12GHz < 3.8dB @ 4.5 to 13.5GHz	< 2.6dB @ 2.6 to 5.2GHz < 2.9dB @ 1.95 to 5.85GHz	

Specifications		models
	6010, 6011, 6012, 6013	
Attenuator		
Setting range	0 to 80dB	
Setting resolution	0.05dB	
Accuracy (at center of frequency range and +10dBm input)	±0.5dB @ 0 to 10dB ±0.8dB @ >10 to 30dB ±1.0dB @ >30 to 50dB ±1.5dB @ >50 to 64dB ±2.0dB @ >64 to 74dB ±3.0dB @ >74 to 80dB	
Impedance	50Ω nominal	
Filter	1μs to 3ms, 1-3 step	
Maximum input level	100mW @ CW or peak power	
Input damage level	0.8W @ average power 20W @ peak power of 1μs pulse	
Input / output connector	SMA	
Readout clock input		
Input level	TTL	
Maximum frequency	500kHz	
Input impedance	10kΩ ±5%	
Minimum pulse width	200ns (for TTL low and high)	
Input damage level	±20V (DC + peak AC)	
Connector	BNC	
Trigger input		
Input level	TTL	
Input impedance	10kΩ ±5%	
Minimum pulse width	> 1μs	
Input damage level	±20V (DC + peak AC)	
Connector	BNC	
SYNC output		
Output level	TTL	
Rise / Fall time	< 100ns	
Output impedance	approx. 100Ω	
Connector	BNC	
Functions		
Attenuation value set mode	Manual and Program	
Program mode		
Program length	8 to 131072 words, (can be set in one word steps)	
Readout clock		
Internal clock	100Hz to 500kHz, 1-2-5 step	
External clock	DC to 500kHz	
Manual clock	Press ENTER key for Single Trigger	
Pause Time		
Clock setting	0 to 65535 readout clock cycles in 1 clock cycle increments	

Time setting	0 to 6.5535sec (in 100μs increments)
Execution mode	Free, Burst, Gate
Nonvolatile program memory	Program data is automatically saved when power is turned off.
Software for generating attenuation profiles	
Supported OS	Windows98/Me/2000/XP/Vista
Standard waveforms	Sine, Triangle, Square, Ramp, sin x/x, 1-e ^{-ax} , e ^{-ax} and DC
Parameters	Data length, Amplitude, Offset, Number of Cycles, Phase, Duty Cycle (only Square wave), Zero cross (only sinX / X), Damp Factor
Straight line	Connect two or multiple points with a straight line
Math functions	+, -, x, Clipping, Absolute, Mirror, Smoothing, Resize, Offset
Editing options	Cut, Copy, Paste, Undo, Delete
File menu	New, Open, Close, Save, Save as, Data import, Data export, Print, Printer setup, Transmit, Exit
Others	
Display	LCD (20 characters x 2 columns)
Interfaces	
RS-232C	Standard (baudrate: 2,400 to 57,600bps)
GPIB	Standard
Environmental	
Operating temperature	0 to 40°C (Guaranteed at 23 ±5°C)
Operating humidity	less than 40°C / 80%RH (Guaranteed at less than 28°C / 80%RH)
Storage temperature	-10 to +60°C / less than 80%RH
Power Supply	90 to 132VAC / 180 to 250VAC (selectable by a switch located on rear panel)
Dimensions	8.11" (W) x 4.53" (H) x 14.18"(D) (excluding projections) 260 (W) x 115 (H) x 360 (D) mm (excluding projections)
Weight	10 lbs (4.5kg)
Accessories	
One Year Warranty	
SUPPLIED: Operating manual (1pc), Power cord (1pc), Fuse (1pc), Installation CD for creating attenuation profiles (1pc), RS-232C cable (1pc)	

Counters



1823A



1856D

2.4GHz Universal Frequency Counter with Ratio Function Model 1823A

The model 1823A is a reciprocal 2.4GHz universal frequency counter that is microprocessor controlled. The LED display can provide eight digits of resolution using the internal 10S gate time. The high accuracy, sensitivity and versatility of this counter make it an extremely valuable instrument to scientists, engineers, experimenters and communications technicians.

- ± 1 PPM Time base stability
- Trigger function
- Frequency ratio measurement function
- Time interval measurement function
- External frequency standard input
- Bright LED display
- Attenuator
- Period
- Total
- Low pass filter
- Line filter
- RS232 Interface

3.5GHz Frequency Counter Model 1856D

B+K Model 1856D, a high-quality, lightweight frequency counter capable of frequency measurements from 0.1Hz to 3.5GHz to its expanding line of cost-effective instruments. This compact, versatile, easy to use, highly reliable counter is ideal for a broad spectrum of laboratory and service applications. The Model 1856D Frequency Counter offers excellent performance and flexibility and its exceptional accuracy, sensitivity and range make this an extremely valuable instrument for scientists, engineers, and communications technicians

- Wide measuring range up to 3.5GHz
- Bright nine-digit LED display
- Period mode for accurate low frequency measurement
- Totalize mode permits counting of individual events
- Accurate TCXO time base

Specifications

	1823A	1856D	1803D	1804D
Range	2.4GHz	3.5GHz	200MHz	1.0GHz
FUNCTIONS				
Frequency	√	√	√	√
Totalize	√	√		
Period	√	√		
Time Base Stability	± 1 ppm	± 1 ppm	± 10 ppm	± 10 ppm
Best Resolution	1 nHz	1n Hz	1 Hz	1Hz
No. of Digits	8	9	7	8
Display Hold	√	√		
Low Pass Filter	√	√		
Sensitivity	30 mVrms	10 mVrms	25 mVrms	50mV
Remote Start-Stop		√		
Self Test		√		



1803D

Frequency Counters Models 1803D & 1804D

- Selectable gate times 0.1 sec and 1.0 sec
- High accuracy time display
- Compact bench top AC powered counter
- Wide measuring range up to:
200MHz(model 1803D)
1.0GHz(model 1804D)

Counters

Specifications		models			
	1823A	1856D	1803D	1804D	
FREQUENCY					
KHz MODE	5Hz to 10MHz sinewave		10Hz to 25MHz sinewave	10Hz to 16MHz	
MHz MODE	5Hz to 100MHz sinewave		10MHz to 200MHz sinewave	10MHz to 1.0 GHz	
	50MHz to 3.5GHz (2.4GHz model 1823A) sinewave (prescale)				
ACCURACY	± Time base accuracy +1 count		± Time base accuracy +1 count		
PERIOD CHARACTERISTICS					
RANGE	0.285 μs to 200,000 μs		Does not apply	Does not apply	
INPUT CHARACTERISTICS					
SENSITIVITY	0.1Hz to 1Hz: 250mV 1Hz to 100MHz: 30mV	20 mV rms, 5Hz to 30 MHz, 50 mV rms above 100 MHz	25 mV rms, 5Hz to 30 MHz, 50 mV rms 30 MHz to 100 MHz	50mV (10Hz to 200MHz)	
IMPEDANCE	1 MΩ (<40 pF)		Direct: 1MΩ	HF= 1MΩ, VHF=50Ω	
ATTENUATOR	X1/X10, switch selectable				
COUPLING	AC or DC		AC	AC	
FILTER	100 kHz, -3 dB switch selectable				
PRESCALE					
SENSITIVITY	25mV from 80MHz to 150MHz 20mV from 150MHz to 2.0GHz 60mV from 2.0GHz to 2.4GHz	15mV from 80 MHz to 2000MHz 20mV from 2000MHz to 3.0GHz 30mV from 3.0GHz to 3.2GHz 50mV from 3.2GHz to 3.5GHz	Does not apply	Does not apply	
IMPEDANCE	50 Ω				
COUPLING	AC				
MAXIMUM INPUT	3 V rms				
TOTALIZE START/STOP INPUT CHARACTERISTICS					
LOGIC LEVELS	Standard TTL levels				
LOADING	One standard TTL gate				
TIME BASE CHARACTERISTICS					
STANDARD TYPE	TCO		Crystal controlled oscillator		
FREQUENCY	10 MHz		10 MHz	5.24288MHz	
STABILITY	± 1 ppm (± 1 Hz)		± 10 ppm	± 10 ppm	
LINE VOLTAGE STABILITY	< ± 1 ppm ± 10% 10% line volt variation				
TEMPERATURE STABILITY	± 5ppm (from 0°C to 40°C)		< ± 10 ppm from 0° to 50°C, 2 ppm 20°C to 30°C	< ± 10 ppm from 0° to 50°C	
DISPLAY CHARACTERISTICS					
DISPLAY	0.56" seven segment LED - 9 digits		0.43" seven segment LED - 7 digits	0.43" seven segment LED - 8 digits	
LED INDICATORS	For kHz, MHz, μsSEC, Gate, and overflow indicators		N/A	N/A	
GENERAL					
POWER REQUIREMENTS 50/60 Hz 12W	103 ~ 252 VAC 50/60 Hz (Selectable)		9VDC 300mA	7-10VDC with 800mA	
DIMENSIONS (H x W x D)	3.5 x 9.4 x 10.6" (90 x 240 x 270mm)		2.1 x 9.06 x 6.18" (54 x 230 x 157mm)	2.1 x 9.06 x 6.18" (54 x 230 x 157mm)	
WEIGHT	5.5 lbs (2.5 kg)		1.8 lbs. (680 g)	1.8 lbs. (680 g)	
Accessories		One Year Warranty			
SUPPLIED: Instruction Manual, all models; AC adapter for models 1803D & 1804D					
OPTIONAL:	AT-21 antenna kit,	AT-21 antenna kit,	AT-21 antenna Kit	AT-21 antenna Kit	

Electrical Testers

AC Line Separator Model 301



The 301 is intended to be used with an AC Current Clamp Meter. It provides temporary separation of conductors to facilitate measurement of current. Most 120Vac devices use a two conductor power cord which makes it difficult to isolate a single conductor to make a current measurement. A single conductor is required to make a measurement because a two conductor measurement will cancel each other out.

Features

- X10 Mode allows for more accurate measurements of low amperage devices
- Direct reading in X1 mode
- 2mm Voltmeter measurement points
- Integrated ground conductor (three pronged US standard plug)
- 15 amp capacity

Applications

- Monitor a devices power consumption
- Measure surge current

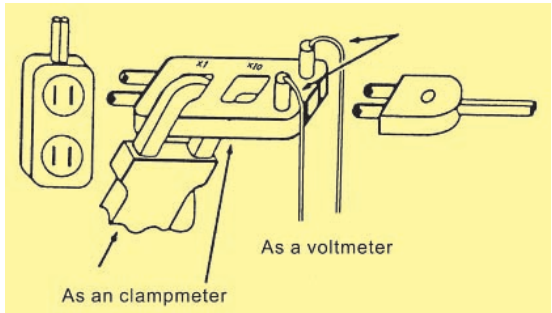

Phase & Motor Rotation Meter Model 302

The model 302 is a 3 phase presence and rotation meter combined with a 3 phase motor rotation tester. It is the quickest and easiest way for servicing, repairing and electrical maintenance of 3 phase systems and 3 phase rotating machinery. It can be utilized on a 3 phase powered system (the supply side) or on a three phase un-powered motor (the load side) without having to worry about damage to the tester. When utilized on a 3 phase powered system, the instrument is then utilized as a 3 phase presence and rotation indicator. When utilized on a three phase un-powered motor, the instrument is then utilized as a 3 phase motor rotation tester. When utilized on a 3 phase powered system, this instrument is a rotary field indication instrument which display all three phase by lighting up its corresponding LED. It displays the rotation (clockwise or counter-clockwise) on a LED. When utilized on a 3 phase un-powered motor, it is also possible to determine the motor connections U, V, W without a live circuit to avoid subsequent damages of e.g. pumps to reversed motor rotation. It displays the rotation (clockwise or counter-clockwise) on a LED.

Features

- Indicates Phase Presence
- Indicates Phase Rotation
- Indicates Motor Rotation / Wiring
- Indicates Battery Status
- Phase Rotation and Motor Rotation Indication works from as low as 1Vac
- Small and rugged enclosure
- Phase and Motor Rotation Indicator works from as low as 1Vac
- Color Coded test Leads
- Phase Presence Indication from as low as 100Vac
- Very Low Consumption
- Fused
- Lightweight, Robust & Compact.
- Works from 2 Hz to 400Hz Sine
- IEC/EN 61010-1 CAT III / 600V / CE

Applications

With this equipment, you can, before connecting supply to load :

On the supply side

- Quickly verify the presence of the three phase on a 3 phase power system.
- Confirm the phase rotation on a powered 3 phase system.

On the motor side (Load)

- Confirm the phase rotation on a unpowered 3 phase motor 3 phase alternator.
- Confirm that each winding is connected to the terminals of the motor, when the rotation LEDs light up.

Electrical Testers



300



305



307A



308A

Applications

Why Test is Necessary?

• *Insulation*

Every electrical apparatus and installation needs to be safe for the user and for the equipment itself.

Electrical conductors of electricity needs to be insulated from each other, so that they do not cause electrical hazard or unnecessary consumption. Poorly insulated circuits can create leakage current which can be dangerous and trip your GFCI, RCCB or ELCB.

Each country regulates levels at which the insulation levels are acceptable. Generally, Insulation resistance measurement should be done between each conductor and the earth, and between each conductors.

• *Continuity*

Checking the continuity of wires, complete circuits, connections, closure of contacts, circuit breakers, fuses, bounding resistance of connections, etc... are all very important to ensure wire integrity.

These insulation testers are intended primarily for periodic testing of industrial motors, transformers, electrical wiring, and cable insulation for signs of deterioration. Low readings may indicate impending failure and permit replacement during routine maintenance rather than risking production downtime. Also useful for safety testing of TV sets and appliances to assure no hazardous leakage current. The voltage and resistance ratings for insulation testing are often specified for the product to be tested.

Models 300, 305

- Test insulation resistance
- Measure AC voltage to 600V
- Battery powered
- 1000V, 2000MΩ (Model 300)
- 500V, 1000MΩ (Model 305)

Models 307A, 308A

- Selectable 250V, 500V, or 1000V insulation test
- Low resistance test
- Extra rugged integral carrying case
- Live circuit indicator warns of safety hazard
- Push to test

Specifications

	300	305	307A	308A	models		
Type	Analog	Analog	Analog	Digital			
Output Voltage	1000VDC	500VDC	1000VDC	1000VDC			
Maximum current	250μA	500μA	2mA	1.2mA			
Resistance Range	1MΩ - 2000MΩ	0.2MΩ - 1000 MΩ	1000V 0-200MΩ 500V 0-100MΩ 250V 0-50MΩ	0-2000MΩ 0-2000MΩ 0-2000MΩ			
Center Scale	50MΩ	20MΩ	1MΩ, 2MΩ, 4MΩ	Does not apply			
Accuracy					250V	500V	1000V
		Infinity: within 1% of scale length		0-100Ω	±(1.5%+3D)	±(1.5%+2D)	±(1.5%+2D)
		Zero: within 1% of scale length		100-200MΩ	±(2%+5D)	±(1.5%+2D)	±(1.5%+2D)
		All points ±5% of reading		200-1700MΩ	±(3%+7D)	±(3%+4D)	±(3%+3D)
				1700-2000MΩ	±(4%+8D)	±(4%+6D)	±(4%+5D)
AC Voltage Test							
Range	0 to 600 VDC						
Frequency Response	10Hz to 100kHz						
Accuracy	±4% of full scale						
Low resistance Test	Does not apply		0-50Ω	0-200Ω			
Accuracy	Does not apply		±5% of reading	±(1.5% + 2 digits)			
General Specifications							
Power Requirements	Six "AA" cells (supplied)			Eight "AA" cells (supplied)			
Battery Life	4 hours typical alkaline		12 hours continuous	10 hours continuous w/alkaline			
Operating Temperature	32° to 122°F (0° to 50°C), ≤ 70% RH						
Storage Temperature	-4° to 140°F (-20° to 60°C), < 80% RH (with batteries removed)						
Dimensions	6.66 x 4.18 x 1.42" (169 x 106 x 36mm)			7 x 8.5 x 3.5" (180 x 220 x 90mm)			
Weight	15oz. (430g) w/batteries			2.6 lbs (925g) with batteries			

Accessories

One Year Warranty

Supplied:	Batteries, Carrying Case, Test Leads, Instruction Manual	Batteries, Integral Carrying Case w/strap, Test Lead, Instruction Manual
-----------	--	--

For more product information please visit www.bkprecision.com

Electrical Testers

Digital Earth Resistance Meter Model 309

The model 309 Digital Earth Resistance Meter is a small, compact, battery powered, professional meter. This easy-to-use meter is invaluable to electricians and contractors who need to ensure the "ground" quality and effectiveness of buildings, structures, equipment or electrical systems. A good earth ground is required for new buildings or structures needing to pass required electrical codes. Older buildings can lose a good, effective earth ground connection over time. This can happen after a building or structure has been struck by lightning.



Features

- Measure Earth Resistance (20/200/2000Ω ranges)
- Measures Earth AC Voltage to 200VAC (40 to 500Hz)
- Timed function test turns output off after a 3 to 5 minutes continuous test
- 2mA Measuring current measures resistance without tripping circuit breakers
- Data Hold
- Small Light Weight
- Auto Power Off
- IEC 1010 CAT III 200V / CE
- Included: Test Leads, Auxiliary Earth Spikes, Carrying Case and Batteries

Earth Voltage Measurement

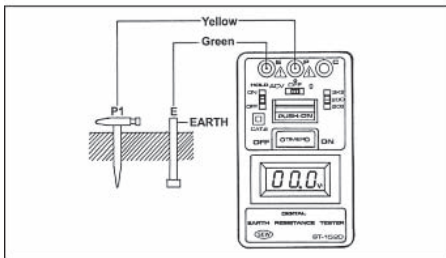

Earth Resistance Measurement

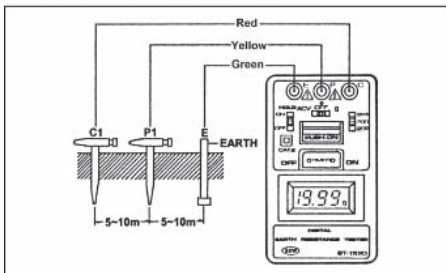

Specifications

	309	model
Measurement Ranges		
Earth Resistance	0 - 20Ω / 0 - 200Ω / 0 - 2000Ω	
Earth Voltage	0 - 200V AC (40 - 500Hz)	
Accuracy		
Earth Resistance	±(2% rdg + 2 dgt) or ±0.1Ω, which is greater	
Earth Voltage	±(1% rdg + 2 dgt)	
Earth Resistance Resolution	0 - 20Ω (0.01Ω) 0 - 200Ω (0.1Ω) 0 - 2000Ω (1Ω)	
Measurement System	Earth resistance by constant current inverter 820Hz approx. 2mA.	
Low Battery Indication	"B" symbol appears on the display	
Data Hold Indication	"DH" symbol appears on the display	
Over Range Indication	"1" (MSD)	
Open Circuit Indication	LED will be unlit	
Display LCD	3 1/2 digit (2000 counts)	
Power Source	1.5V (AA) Ω 6	
Dimensions (LxWxD)	6.4" x 3.93" x 1.97" (163 x 100 x 50 mm)	
Weight	1.05 lbs. (480g) (battery included)	

Accessories

One Year Warranty

SUPPLIED	Test leads (red, yellow, green), Auxiliary earth bars Heavy-duty case, Instruction manual, Batteries
----------	---

Specifications and information are subject to change without notice. Please visit www.bkprecision.com for the most current product information.

Electrical Testers

Digital Milli-Ohm Meter

Model 310

The model 310 Digital Milli-Ohm Meter is used to ensure continuity and integrity of a wire, cable, conduit or any electrical connection. The 310 has a display resolution of 100 micro-Ω and has a professional four wire Kelvin test lead set included to ensure accurate readings. The heavy duty case has a rubber seal to make the unit water resistant and a convenient shoulder strap.

Features

- Four wire Kelvin lead measurements
- Over-voltage and over-temperature protection
- 5 ranges with 100μ ohm max resolution
- Water resistant case with shoulder strap
- Auto Power Off
- IEC/EN 61010-1 / CE
- Included: 4-Wire Kelvin Leads, Carrying Case with Shoulder Strap and Batteries



Simplified Measurement

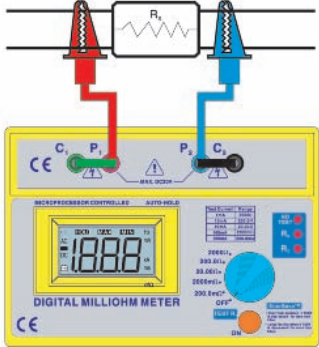

Applications

The model 310 Digital milli-ohmmeter, with its measuring range of 100 μΩ to 2000 Ω, is suitable for a wide range of applications such as:

- Measuring the winding resistance of electric motors, generators and transformers
- Bond testing in mines, aircraft, railways, ships, domestic and industrial wiring installations
- Measuring the ring main continuity testing in industrial and domestic wiring installations
- Measuring resistance in electronic equipment such as shunts, PCB tracks, switch and relay resistance
- Checking compression joints on overhead lines
- Testing and maintenance of switchboard /sub-station equipment on such items as fuses, joints, contacts and bonds



Specifications

	310	model
Measuring Ranges	0 - 200.0mΩ in steps of 100μΩ 0 - 2000mΩ in steps of 1mΩ 0 - 20.00Ω in steps of 10mΩ 0 - 200.0Ω in steps of 100mΩ 0 - 2000Ω in steps of 1Ω	
Accuracy	±0.5% of reading ±2 digits over the operating temperature range, -15°C to +55°C, with the supplied test leads	
Test Current	1mA => 2000 Ω range 10mA => 200 / 20 Ω ranges 100mA => 2000m / 200m Ω ranges	
Test Current Accuracy	±0.1%	
Protection Fuses		
Mains	0.5A, HBC, 5 Ω 20mm, DIN	
Current	1A, HBC, 5 Ω 20mm, DIN	
Voltage	0.5A, HBC, 5 Ω 20 mm, DIN	
Maximum Output Voltage (C1-C2)	20V	
Dimensions (LxWxD)	9.84" x 7.48" x 4.33" (250 x 190 x 110 mm)	
Weight	3.3 lbs. 1500g	
Accessories		One Year Warranty
Accessories Included	Test Leads, Instruction manual, Shoulder belt 1.5V (AA) x 8 Batteries	

Specifications and information are subject to change without notice. Please visit www.bkprecision.com for the most current product information.

Battery Capacity Analyzers



600



Batteries

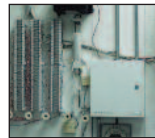

communications



Alarms



UPS's



Sprinkler Systems

Models 600, 601, 602

B+K Precision® Battery Capacity Analyzers tests Lead Acid Batteries and displays the batteries stored charge capacity as a percentage and displays both the batteries loaded and un-loaded battery voltage. Models 601 and 602 can also display the battery under test's internal resistance. These units identify batteries, which may be defective or deteriorated. They are perfect tools for testing battery back up systems for emergency lighting, alarm, sprinkler systems, UPS devices and any system using lead acid batteries to provide power.

Applications

The need for battery maintenance tools is growing for use in Automotive, Field Service and Maintenance, Telecommunications, and UPS Manufacturing/Maintenance applications. These three models are the perfect instruments for anyone working with UPS systems, Emergency back-up Flood Lights, Home and Business Security Alarm Systems, or for any applications using a lead acid battery.

- Measures both No Load Voltage and Battery Capacity
- Displays storage capacity of 12V Lead Acid Batteries as a percentage
- Great tool for testing back up batteries for UPS, Security, Emergency Flood Light systems
- Ideal for Automotive, UPS Maintenance, and Telecommunication applications
- Powered by Battery Under Test



601



602

Specifications

	models		
	600	601	602
Testable Battery Voltages	12V	6 & 12V	24 & 36V (42V)
Max. Input Voltage	20V	20V	50V
Selectable Amp Hours	7, 12, 24, 42, 65, 100	1 - 100AH in 1AH steps	
Dimensions (WxHxD)	3.14 x 6.3 x 1.6" (80 x 160 x 40mm)	3.14" x 9.5" x 1.6" (80 x 240 x 40mm)	
Weight	2.2 lbs. (1 kg)	2.31 lbs (1.04 kg)	

Accessories

One Year Warranty

SUPPLIED: Instruction Manual

The Model 601/602 hand-held Battery Capacity Analyzers provide a complete battery analysis in as little as 6 seconds. They measure and digitally display the percentage of capacity left in the battery. The units are simple to operate and require no external power since they are powered by the battery under test (BUT). The new analyzers support 6VDC & 12VDC (Model 601) and 24VDC & 36 VDC (Model 602) storage type lead acid batteries with a wide range of AH capacity and measures both No Load Voltage and Battery Capacity. By simply selecting the proper AH range and pressing the TEST switch, the user can obtain the BUT's percentage balance capacity.



885



SMD Probe (included)

Synthesized In-Circuit LCR/ESR Meter Models 885 and 886

The Model 885 and 886 Synthesized In-Circuit LCR/ESR Meters are the first handheld meter of this type on the market, with a wide range of test frequencies up to 10 kHz for model 885 and 100kHz for model 886 many measurement parameters including Z, L, C, DCR, ESR, D, Q, and \emptyset as well. The 885 and 886 are designed for both component evaluation on the production line and fundamental impedance testing for bench-top applications. With a built-in direct test fixture, you can test the lead components very easily. The optional 4-wire test clip can give a convenient connection to larger components and assemblies with the accuracy of 4-wire testing. The LCR meters offer fast, reliable, and versatile testing at low cost, making the 885 and 886 the most advanced handheld LCR meters available on the market today.

Features:

- Measurement parameters: Z, L, C, DCR, ESR, D, Q, and \emptyset
- Test conditions: 100Hz, 120Hz, 1kHz, 10kHz, 100kHz(model 886 only), 1Vrms, 0.25Vrms, 0.05Vrms
- 0.5% basic accuracy
- Dual LCD display
- SMD Surface Mount Tweezer Probe included
- Very quick response, user friendly
- Fully auto/manual selection
- DC resistance measurement
- Rechargeable battery / AC powered
- Infrared RS-232 interface capability

Software Features:

- Go-No Go testing (component sorting)
- Remote bin (component grading)
- Remote operation

Synthesized In-Circuit LCR/ESR Meter

Digital Mode Specifications

models

885, 886

TEST SIGNAL	
Frequency	100Hz, 120Hz, 1kHz, 10kHz, 100kHz(model 886 only)
Frequency Accuracy	±0.1%
Level	1Vrms, 0.25Vrms, 0.05Vrms, 1Vdc (for DCR)
level Accuracy	±5%
Output Impedance	100Ω, ±5%

Measurement Range

Impedance (Z):	Frequency	Max.	Min.	Best Resolution
	DCR	20MΩ	0.1Ω	0.001
Capacitance (C):	100Hz	20MΩ	0.1Ω	0.001
	120Hz	20MΩ	0.1Ω	0.001
	1kHz	20MΩ	0.1Ω	0.001
	10kHz	20MΩ	0.1Ω	0.001
	100kHz	20MΩ	0.1Ω	0.001
	Inductance (L):	100Hz	20MΩ	0.1Ω
120Hz		20MΩ	0.1Ω	0.001
1kHz		20MΩ	0.1Ω	0.001
10kHz		20MΩ	0.1Ω	0.001
100kHz		20MΩ	0.1Ω	0.001

GENERAL

Operating Temperature	32° to 104°F (0° to 40°C)
Storage Temperature	-4° to 158°F (-20° to 70°C)
Relative Humidity	up to 85%
Battery Type	Ni-MH or Alkaline (2 x AA size)
Battery Charge	Constant current 150mA approximately
Battery Operating Life	2.5 hours typical
AC Operation	110V/220V AC, 60/50Hz with proper adapter
Low Power Warning	under 2.2V
Dimensions (LxWxH)	6.9 x 3.4 x 1.9" (175 x 86 x 48mm)
Weight	1.1 lbs (470g)

RANGE	20MΩ	10MΩ	1MΩ	100kΩ	10Ω	1Ω
FREQ.	~10MΩ	~1MΩ	~100kΩ	~10Ω	~1Ω	~0.1Ω
DCR						
100/120Hz	2% ± 1	1% ± 1				
1kHz			0.5% ± 1	0.2% ± 1	0.5% ± 1	1% ± 1
10kHz	5% ± 1	2% ± 1				
100kHz	NA	5% ± 1	2% ± 1	0.4% ± 1	2% ± 1	5% ± 1

Accessories

Two Year Warranty

SUPPLIED:	Instruction Manual, SMD Probe, Rechargeable Battery, AC Adapter
OPTIONAL:	TL885B 4-wire test leads
	TL08C 4-wire Kelvin test leads
	LC 29B Carrying Case

Bench LCR/ESR Meter with Component Test



Bench LCR/ESR Meter with Component Test Model 889A

The B&K Precision Corp. 889A Synthesized In-Circuit LCR/ESR Meter is a high accuracy test instrument used for measuring inductors, capacitors and resistors with a basic accuracy of 0.1%. Also, with the built-in functions of DC/AC Voltage/Current measurements and Diode/Audible Continuity checks, the 889A can not only help engineers and students to understand the characteristics of electronics components but also being an essential tool on any service bench.

Features:

- **Measurement parameters: Z, L, C, DCR, ESR, D, Q, ACV, DCV, ACA, DCA and Ø**
- **Test conditions: 100Hz, 120Hz, 1kHz, 10kHz, 100KHz, 200KHz, 1Vrms, 0.25Vrms, 0.05Vrms**
- **0.1% basic accuracy**
- **Dual LCD display**
- **Very quick response, user friendly**
- **Fully auto/manual selection**
- **DC resistance measurement**
- **RS-232 interface capability**

Digital Mode Specifications model

	889A
TEST SIGNAL	
Frequency	100Hz, 120Hz, 1kHz, 10kHz, 100KHz, 200KHz
Frequency Accuracy	±0.1%
Level	1Vrms, 0.25Vrms, 0.05Vrms, 1Vdc (for DCR)
level Accuracy	±5%
Output Impedance	100Ω, ±5%

Measurement Range

	Frequency	Max.	Min.	Best Resolution
Impedance (Z):	DCR	20MΩ	0.1Ω	0.001
	100Hz	20MΩ	0.1Ω	0.001
	120Hz	20MΩ	0.1Ω	0.001
	1KHz	20MΩ	0.1Ω	0.001
	10KHz	20MΩ	0.1Ω	0.001
	100KHz	20MΩ	0.1Ω	0.001
	200KHz	20MΩ	0.1Ω	0.001
Capacitance (C):	Frequency	Max.	Min.	Best Resolution
	100Hz	15.91mF	79.57pF	0.001
	120Hz	13.26mF	66.31pF	0.001
	1KHz	1.591mF	7.957pF	0.001
	10KHz	159.1μF	0.795pF	0.001
	100KHz	15.91μF	0.159pF	0.001
Inductance (L):	Frequency	Max.	Min.	Best Resolution
	100Hz	9999H	159.1μH	0.001
	120Hz	9999H	132.6μH	0.001
	1KHz	3183H	15.91μH	0.001
	10KHz	318.3H	1.591μH	0.001
	100KHz	31.83H	0.159μH	0.001
	200KHz	15.91H	0.079μH	0.001

GENERAL

Operating Temperature	32° to 104°F (0° to 40°C)
Storage Temperature	-4° to 158°F (-20° to 70°C)
Relative Humidity	up to 85%
AC Operation	110V/220V AC, 60/50Hz
Dimensions (LxWxH)	11.8" x 8.7" x 5.9" (300 x 220 x 150mm)
Weight	10 lbs (4.5kg)

Accessories Two Year Warranty

SUPPLIED: Instruction Manual, Kelvin Probe (TL 889A), Line Cord

TL 889A Kelvin Clip to four BNC Lead

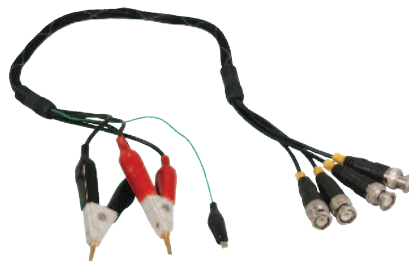

Specifications

	models		
	878A, 879	875B	815
CAPACITANCE			
RANGE (Best Resolution)	1000pF (0.1pF) 10nF (1pF) 100nF (10pF) 1000nF (100pF) 10μF (1nF) 100μF (10nF) 1000μF (100nF) 10mF (10μF)	200pF (0.1pF) 2nF (1pF) 20nF (10pF) 200nF (100pF) 2μF (1nF) 20μF (10nF) 200μF (100nF) 2mF (1μF) 20mF (10μF)	200pF (0.1pF) 2nF (1pF) 20nF (10pF) 200nF (100pF) 2μF (1nF) 20μF (10nF) 200μF (100nF) 2000μF (1μF) 20mF (10μF)
ACCURACY	±1% + 5 counts ±0.7% + 5 counts ±0.7% + 3 counts ±0.7% + 3 counts ±0.7% + 3 counts ±0.7% + 3 counts ±1% + 5 counts ±5% + 5 counts	±(1%rdg + 2dgt) ±(1%rdg + 2dgt) ±(1%rdg + 2dgt) ±(1%rdg + 2dgt) ±(1%rdg + 2dgt) ±(1%rdg + 2dgt) ±(1%rdg + 2dgt) ±(1%rdg + 2dgt) ±(2%rdg + 10 dgt) ±(2%rdg + 10 dgt)	±(0.5% rdg + 1dgt) ±(0.5% rdg + 1dgt) ±(0.5% rdg + 1dgt) ±(0.5% rdg + 1dgt) ±(0.5% rdg + 1dgt) ±(0.5% rdg + 1dgt) ±(0.5% rdg + 1dgt) ±(1%rdg + 1 dgt) ±(1.5%rdg + 1dgt)
RESISTANCE			
RANGE (Best Resolution)	10Ω (1mΩ) 100Ω (10mΩ) 1kΩ (100mΩ) 10kΩ (1Ω) 100kΩ (10Ω) 1MΩ (100Ω) 10MΩ (1kΩ)	2Ω (1mΩ) 20Ω (10mΩ) 200Ω (100mΩ) 2kΩ (1Ω) 20kΩ (10Ω) 200kΩ (100Ω) 2MΩ (1kΩ) 20MΩ (10kΩ)	200Ω (100mΩ) 2kΩ (1Ω) 20kΩ (10Ω) 200kΩ (100Ω) 2MΩ (1kΩ) 20MΩ (10kΩ)
ACCURACY	1.2% + 8 counts 0.8% + 5 counts 0.5% + 3 counts 0.5% + 3 counts 0.5% + 3 counts 0.5% + 5 counts 2.0% + 8 counts	±1%rdg + 5 dgt ±1%rdg + 2 dgt ±1%rdg + 2 dgt ±1%rdg + 2 dgt ±1%rdg + 2 dgt ±1%rdg + 2 dgt ±2%rdg + 2 dgt ±2%rdg + 2 dgt	±0.75%rdg + 5 dgts ±0.5%rdg + 1 dgt ±0.5%rdg + 1 dgt ±0.5%rdg + 1 dgt ±0.75%rdg + 1 dgt ±2.0%rdg + 1 dgt
INDUCTANCE			
RANGE (Best Resolution)	1mH (100nH) 10mH (1μH) 100mH (10μH) 1H (100μH) 10H (1mH) 100H (10mH) 1000H (100mH)	200μH (100nH) 2mH (1μH) 20mH (10μH) 200mH (100μH) 2H (1mH) 20H (10mH) 200H (100mH)	Not applicable
ACCURACY	±2.0% + 5 counts ±1.2% + 5 counts ±0.7% + 5 counts ±0.7% + 5 counts ±0.7% + 5 counts ±0.7% + 5 counts ±1.0% + 5 counts	±2%rdg + 2 dgt ±1%rdg + 2 dgt ±1%rdg + 2 dgt ±1%rdg + 2 dgt Not Specified Ranges are used for reference only	Not applicable
GENERAL			
POWER SOURCE	9V Battery	9V Battery	9V Battery
DISPLAY	4 digit LCD (dual)	3 1/2 digit LCD	3 1/2 digit LCD
DIGIT HEIGHT	0.5/0.3" (13/7.6mm)	0.5" (13mm)	0.8" (20mm)
OPERATING TEMP	32° to 104°F (0° to 40°C)	32° to 104°F (0° to 40°C)	32° to 122°F (0° to 50°C)
STORAGE TEMP	-4° to 122°F (-20° to 50°C)	-4° to 158°F (-20° to 70°C)	-4° to 140°F (-20° to 60°C)
DIMENSIONS (L x W x D)	7.56 x 3.54 x 1.46" (192 x 90 x 37 mm)	6.97 x 3.47 x 1.58" (177 x 88 x 40 mm)	6.88 x 3.25 x 1.5" (175 x 83 x 38 mm)
WEIGHT	13.76 oz. (390g)	14.12 oz. (400g)	11.6 oz. (326g)
Accessories	One Year Warranty	Three Year Warranty	One Year Warranty
SUPPLIED: Test Lead; Spare Fuse (Except 875B); AC Power Adapter (Model 878A) OPTIONAL: TL 8 SMD Probe, Carrying Case (Not included); LC 29B			

Component Testers

Dual Display Auto Ranging LCR Meter Model 878A

The 878A and 879 measure capacitance, resistance (of non-inductive components) and inductance. Components can be measured with selectable test frequencies in series or parallel modes as desired. The 4 1/2 digit main LCD displays values to 19,999, and the secondary 3 digit 1,000 count display reads D or Q. Both models can be used in either auto ranging or manual ranging modes.

Deluxe Dual Display Auto Ranging LCR Meter Model 879



879

- Selectable test frequencies 100Hz, 120Hz, 1KHz, 10KHz (100Hz & 10KHz model 879 only)
- Simultaneously displays measured component value and Q or Dissipation Factor (D)
- Display hold
- Relative mode
- Tolerance mode
- Backlight (model 879)
- RS 232 Interface (cable and software required)

Low-Ohm LCR Meter Model 875B

The rugged 875B LCR is a reliable easy-to-use workhorse that will measure inductors, resistors and capacitors quickly and accurately. Utilizing special circuitry, the measurement more closely replicates true in-circuit measurements. Ten range resistance range measures to 0.001 - zero adjust removes leads resistance.



- Precision measurement of very low resistances
- Measures D (dissipation factor)
- Unique drop-proof construction
- Tilt stand

Hand-held Component Tester Model 815

This handy capacitance meter (0.1 pF-20 mF) and ohm meter (0.1Ω to 20MΩ) also tests: transistors, beta, diodes, SCRs, LEDs and batteries. Use with TL 8 (shown on page 90) for more effective testing.



- 3 1/2 digit extra large (0.8" digit) high contrast LCD display
- Transistor leakage test
- Capacitance zero adjustment
- Diode and SCR test
- LED test
- Battery test
- 5 foot drop-proof heavy duty case

Capacitance Meters

Specifications

	models		
	890B	830B	810C
CAPACITANCE			
RANGE (Best Resolution)	1000pF (0.1pF) 10nF (1pF) 100nF (10pF) 1000nF (0.1nF) 10μF (1nF) 100μF (10nF) 1000μF (0.1μF) 10mF (1μF)	199.99mF (10μF)	200pF (0.1pF) 2nF (1pF) 20nF (10pF) 200nF (100pF) 2μF (1nF) 20μF (10nF) 200μF (100nF) 2000μF (1μF)
ACCURACY	±(1%rdg + 11dgt) ±(1%rdg + 6dgt) ±(0.5%rdg + 4dgt) ±(0.5%rdg + 4dgt) ±(0.5%rdg + 4dgt) ±(0.5%rdg + 4dgt) ±(0.5%rdg + 4dgt) ±(1%rdg + 6dgt) ±(2%rdg + 6dgt)	±(0.5% rdg + 1 dgt) ±(0.5% rdg + 1 dgt) ±(0.5% rdg + 1 dgt) ±(0.5% rdg + 1 dgt) ±(0.5% rdg + 1 dgt) ±(0.5% rdg + 1 dgt) ±(0.5% rdg + 1 dgt) ±(2% rdg + 1 dgt) ±(4% rdg + 1 dgt)	±(0.5% rdg + 1 dgt) ±(0.5% rdg + 1 dgt) ±(0.5% rdg + 1 dgt) ±(0.5% rdg + 1 dgt) ±(0.5% rdg + 1 dgt) ±(0.5% rdg + 1 dgt) ±(0.5% rdg + 1 dgt) ±(2% rdg + 1 dgt) ±(4% rdg + 1 dgt)
POWER SOURCE			
	9V Battery	9V Battery	9V Battery
BATTERY LIFE	80 hours typ. (alkaline)	80 hours typ. (alkaline)	200 hours typ. (alkaline)
DISPLAY	4 1/2 digit LCD (dual)	4 1/2 digit LCD (dual)	3 1/2 digit LCD
DIGIT HEIGHT	N/A	N/A	0.56" (14mm)
OPERATING TEMPERATURE	32° to 122°F (0° to 50°C)	32° to 122°F** (0° to 50°C)**	32° to 104°F (0° to 40°C)
STORAGE TEMPERATURE	-4° to 140°F (-20° to 60°C)	-4° to 140°F (-20° to 60°C)	14° to 140°F, <70% RH (-10° to 60°C)
DIMENSIONS (L x W x D)	7.24 x 3.42 x 1.61" (184 x 87 x 41 mm)	7.24 x 3.42 x 1.61" (184 x 87 x 41 mm)	6.75 x 3.0 x 2.25" (171 x 76 x 57 mm)
WEIGHT	11.3 oz. (320g)	11.3 oz. (320g)	11.3 oz. (200g)
Three Year Warranty			One Year Warranty

Accessories

SUPPLIED	Test Leads, Manual, Battery	Test Leads, Manual, Battery, Software (AK-80B), Interface Cable, and AC Adaptor	Test Leads, Manual, Battery
OPTIONAL	TL 8 SMD Probe, AK-80B Software, RS-232 Cable	TL 8	TL 8
Carrying Case (Not included)	LC 29B		LC 29B

** 59° to 95°F (15° to 35°C) for specified accuracy

Additional Specifications

	810C model
EXCITATION VOLTAGE	< 3.5 V Max. (approximate)
ZERO ADJUSTMENT RANGE	+20 pF typical
PROTECTION	Input protected by 0.1A/ 250 V Fast Acting.
MEASUREMENT RATE	2 per second, nominal.

The Model 810C Capacitance Meter is a compact capacitance meter, designed for accurate measurement of capacitive components. It features direct plug-in test sockets and test lead jacks. A zero adjustment knob is also provided to "zero" test lead capacitance.

- Zero adjustment knob
- Capacitor test sockets
- Fuse protected
- Protective rubber boot



Capacitance Meter
Model 810C

B&K Precision Corporation's Model 830B Capacitance Meter is a compact, hand held, light weight, battery powered test unit featuring a large 4 1/2 digit LCD display, 11,000 counts resolution, and nine (9) automatically selected ranges with full scale value from 1.0pF to 199.99mF. Designed to meet the latest international safety standards, the Model 830B's dedicated chip and microprocessor allow the user to program high/low limits, or utilize pre-programmed capacitor tolerances. Software and cabling are provided for PC based data logging and monitoring via a USB interface.

- Dual Display simultaneously displays value and deviation from selected tolerance
- Sort on preset tolerance of 1, 5, and 10%
- Program unique values to sort for specific circuit applications
- USB PC interface and data logging software included



Capacitance Meter
Model 830B

The Model 890B Capacitance Meter features a large 4 1/2 LCD with dual display, 11,000 counts resolution, and 9 automatically selected ranges with full scale value from 1.0pF to 50mF. Designed to meet the latest international safety standards, the meter's dedicated chip and microprocessor allow programmable high/low limits or pre-programmed standard capacitor tolerances, making it ideal for measuring values, inspection, sorting capacitors and testing capacitors against standard tolerances.

- Dual display simultaneously displays value and deviation from selected tolerance
- Sort on preset tolerance of 1, 5, 10%
- Program unique values to sort for specific circuit applications
- USB PC interface for data logging software available



Capacitance Meter
Model 890B

Capacitor Tester

In-Circuit ESR & DCR Capacitor Tester Model 881

Model 881 is a new portable In-Circuit ESR Meter, the new compact hand-held tester can be used to measure the equivalent series resistance of electrolytic capacitors in or out of circuit and can also be used to measure low value non-inductive resistors. Model 881 is a must for anyone that tests or trouble shoots printed circuit boards.

- Measures ESR with a range of 0.1 to 30 ohms
- Three color front panel chart shows ESR readings of Good, Fair, and Bad
- Measures DCR with a range of 0.1 to 30 ohms
- Automatically calibrates internal signal
- 15mVp-p Output test voltage (will not turn on any solid-state devices)
- Includes a one-handed tweezers test probe
- Uses a standard 9VDC battery as power source

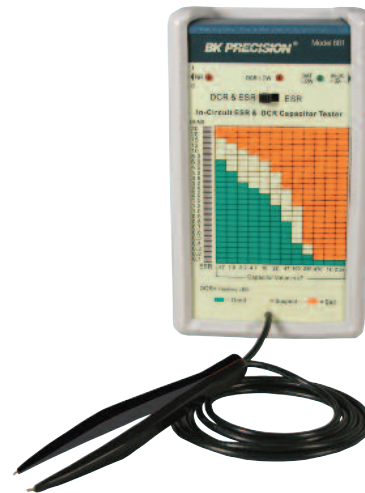

In the past, LCR meters were used to test the value of a capacitor (testing it out of circuit). These meters will indicate that a bad capacitor is good because it only measures its capacitance value, and a bad capacitor can still store the correct amount of charge when it is tested by a LCR meter. By using the Model 881 in its DCR & ESR Mode, the tester can quickly detect a shorted capacitor in its DCR cycle and also determine its ESR value, letting you know right away if a capacitor is good or bad. By performing this test in-circuit, a technician can quickly test many capacitors on the printed circuit board reducing the amount of time normally spent on trouble shooting.

Specifications		model
	881	
Open circuit probe voltage	15mV pp	
Output test frequency	100 KHz sine wave	
Measures ESR		
ESR range ohms	0.1 – 30 (25 segment LED bar scale)	
	Beeps from 1 to 5 beeps depending on ESR of capacitor	
Measures DCR		
DCR range ohms	0.5 – 30 flashing the LED	
Power	One 9V battery or an external AC adapter (9V DC 100mA 5.5mm x 2.1mm center pin+)	
Power drain	10mA typical	
Dimensions	1.5" x 3.8" x 5.7" (38 x 96 x 145 mm)	
Weight	2 lbs. (0.9 kg)	
Accessories		One Year Warranty
SUPPLIED: Instruction Manual		
OPTIONAL: BE 12 AC Adapter, Carrying Case (Not included): LC 29B		

Optional Accessory

LC 29B

Carrying Case

- Light weight, durable Cordura nylon
- Protects your instruments
- Room to hold your test leads



IC Testers

Linear IC Tester Model 570A

The B-K Precision Model 570A emulates passive circuitry around the device under test to ensure that a comprehensive test takes place. High integrity verification offers guaranteed levels of reliability in the results. Conditional and unconditional loop testing modes ensure that intermittent and/or temperature related faults are detected. The unit automatically senses the functionality of the device to be tested and displays a list of possible equivalents for replacement. Unmarked and house-coded ICs are easily identified and tested. As part of the IC test, the specific IC number, the functional description of the device, and the status of faulty pins are scrolled through on the built-in display.

- Auto identification mode
- Conditional/Unconditional loop testing mode
- Functional test unit emulates passive circuitry to implement a comprehensive test in a variety of configurations and gain settings
- Displays diagnostic information down to individual component pins
- Rugged, hand held, battery operated
- Built-in membrane keypad, 2 x 16 dot matrix alphanumeric LCD, and high quality 16 pin ZIF socket
- Battery operated

Digital IC Tester Model 575A

The B-K Precision Model 575A is able to locate intermittent and temperature related faults by using its unconditional or conditional loop testing modes. Unknown device identification is easily accomplished by selecting SEARCH from the menu, selecting the number of pins on the device and activating Search Mode. The 575A will search its library and identify the device, displaying possible functional equivalents for replacement. As part of the IC test, the specific IC number, the functional description of the device, and the status of faulty pins are scrolled through on the built-in display

- Comprehensive device library covers most TTL, CMOS, memory and interface devices
- 40 pin capability (NAND gates or CPUs)
- Identifies unmarked and house-coded devices
- Detects intermittent and temperature related faults
- Displays diagnostic information for individual pins
- Battery operated



570A



575A

The Model 570A Analog and Model 575A Digital hand held IC Testers are compact, hand held, battery powered testers offer advanced functionality and ease of use. The 2-line x 16 character dot matrix LCD shows the result of the test as a PASS or FAIL, together with individual pin diagnostics, test made, and possible equivalents. Both units contain extensive built-in test libraries. The Model 570A Analog IC Tester's built-in test library includes all common Analog ICs including op-amps, comparators, voltage regulators, voltage references, analog switches & multiplexers, opto-isolators & couplers, and audio ICs. The Model 575A Digital IC Tester's built-in test library includes a broad range of TTL, CMOS, memory, LSI, interface and other devices of up to 40 pins.

Specifications

	models	
	570A	575A
POWER SOURCES		
BATTERIES	4 x 1.5V AA	
DC INPUT	6V, 300mA max. regulated	
POWER CONSUMPTION		
POWER OFF	10µA	
STANDBY	30mA	
TEST THRESHOLDS	Logic High: 2.2V Min. Logic Low: 0.8V Max.	Variable (DAC controlled)
LIBRARY ICs*	Operational Amplifiers, Comparators, Operational Amplifiers / Comparators, Voltage Regulators, Voltage References, Analog Switches / Multiplexers, Transistor Arrays, Optoisolators / Optocouplers, DACS / ADSC, Special Functions ICs, Virtual Grounds, Audio ICs	Series 54/74 TTL ICs, CMOS ICs, Memory ICs, Interface, Peripheral, Microprocessor & LSI ICs (75... series, ULN2... series, DS88... series, 8T series, 82... series, 25/26/29... series, 8MC68... series, MC34... series, Z80... series, MC65... series, Intel 80... series, etc.)
GENERAL		
STORAGE TEMPERATURE	-4° to 149°F (-20° to 65°C) <80% RH	
OPERATING TEMPERATURE	32° to 122°F (0° - 50°C) <80% RH	
DIMENSIONS (HxWxD)	7.87 x 3.94 x 2.17" (200 x 100 x 55mm)	
WEIGHT	1.1lbs. (500g)	

Accessories

One Year Warranty

SUPPLIED: Instruction Manual, Batteries

* Please contact factory for the complete IC support list.

Transistor Testers



520C



510A

Industrial Transistor Tester Model 520C

The B-K Precision model 520C Transistor Tester is designed for in-circuit and out-of-circuit transistor testing with special features for making additional tests on devices out-of circuit. The instrument is designed for a minimum amount of control manipulation, making for rapid testing of most devices.

- **Determines good or bad transistors, FET's, SCR's, or diodes**
- **Patented limited-energy pulse circuit permits in-circuit testing in the presence of low shunt impedance's with complete safety for the device under test**
- **Easy to operate panel eliminates the need to refer to a reference or operating manual-only three switches, no panel adjustments**
- **Six position test switch makes it unnecessary to know the device terminal identification**
- **A LED array identifies leakage in both Silicon and Germanium devices**
- **Front Panel socket for out-of -circuit transistor testing**

Portable Transistor Tester Model 510A

The model 510A performs Good/Bad test for transistors, FET's, and SCR's. It also identifies NPN or PNP for transistors, N-channel or P-channel for FET, FET-gate lead, all leads of transistors in LO drive, base lead in HI drive, and all leads of SCR. It uses a patented limited-energy pulse circuit, which provides highly successful in-circuit testing in the presence of low shunt impedance's with complete safety for the device under test. The instrument is designed for a minimum amount of control manipulation, allowing for rapid testing of most devices.

- **Rapid In-circuit and out-of circuit testing**
- **Good/Bad test**
- **NPN or PNP identification for transistors**
- **N-channel or P-channel identification for FET**
- **FET-gate and SCR lead identification**
- **Battery operated (4 x 1.5 AA batteries)**

Specifications

	520C	models 510A
IN-CIRCUIT TEST		
GOOD/BAD TEST	PNP and NPN transistors FET's, SCR's	
IDENTIFIES	NPN or PNP FET as N-channel or P-channel Silicone or germanium transistors transistors in LO drive, base lead in HI drive all leads of SCR	NPN or PNP FET as N-channel or P-channel FET-gate lead, all leads of
OUT-OF-CIRCUIT TEST		
GOOD/BAD TEST	PNP and NPN transistors FET's, SCR's	PNP and NPN transistors FET's
IDENTIFIES	NPN or PNP FET as N-channel or P-channel Silicone or germanium transistors	NPN or PNP FET as N-channel or P-channel
MEASURES	Reverse leakage from 0.1mA to 9mA	Does not apply
AUTOMATIC INDICATORS		
AUDIBLE TONE	GOOD	Does not apply
LED	NPN or PNP, Ge or Si	NPN or PNP, Ge or Si
TEST SWITCH	Base or Gate for good transistor or FET's	Base or Gate for good transistor or FET's
METER SCALES	Readable from 0.1 μ A to 9mA for Ice leakage, calibrated for silicon and germanium power and signal transistor leakage limits	Does not apply
APPLIED TEST CURRENTS		
BASE DRIVE*	250mA (HI), 1mA (LO)	
COLLECTOR*	125mA	
TEST REPETITION	10Hz	5Hz
IN-CIRCUIT SHUNT LIMIT FOR VALID GOOD/BAD TEST		
RESISTANCE	> 10 Ω (HI), 1.5k Ω (LO)	
CAPACITANCE	< 15mF (HI), 0.3mF (LO)	< 25mF (HI), 0.3 μ F (LO)
GENERAL		
POWER REQUIREMENT	9V Battery (Supplied) or optional AC adapter	6VDC from 4 "AA" batteries (not supplied)
OPERATING TEMP	32° to 104°F (0° to 40°C), <75% RH	
DIMENSIONS (HxWxD)	7.5 x 4.0 x 2.0" (191 x 102 x 51 mm)	
WEIGHT	1 lbs. (450g)	

Accessories

One Year Warranty

SUPPLIED: FP 6 Semiconductor Test Leads (three test leads w/mini-lock clips), Instruction manual, Battery (520C only)
Optional: BE 12 AC adapter(9VDC)
* Duty Cycle @8% for 520C, 2% for 510A

Semiconductor Test Leads

Model FP 6

Specialized test lead set for B-K Precision semiconductor testers. Three conductor lead with 4mm banana plugs to mini-IC test clips.

- **3 conductors - Yellow, Green and Blue**
- **30" (76cm) length**



Logic & Pulser Probes

DIGITAL TERMS

CLOCK—A pulse waveform used to synchronize the timing of digital or switching circuits.

COMPARATIVE TESTING—Evaluation of a component by comparing its performance to that of a properly functioning component.

DIGITAL SIGNAL—A discrete signal that assumes one of two states: high or low.

TTL—Transistor logic defines a type of digital circuit. It is characterized by a high digital signal state above 2.4 VDC, and low digital states below 0.8 VDC. Operating voltage is typically 5 VDC.

CMOS—Complementary Metal Oxide Semiconductor defines another type of digital circuit. It is characterized by a variable operating voltage of 3 to 18 V, and logic levels proportional to that operating voltage (typically 1.5 V low and 3.5 V high @ 5 V supply). CMOS circuits are characterized by high noise immunity.

IN-CIRCUIT TESTING—Evaluating the functioning of a component without removing the component from the circuit in which it is being used.

Specifications		model
	DP 31A	
Pulse Repetition Rate	0.5 pps/400 pps	
Pulse width at 100 mA load	10ms	
Output Current	Pulser mode-100mA sink/source square wave mode-5 mA sink/source	
Operating Supply Voltage Range	5-15 V	
Sync Input Impedance	1 MΩ	
Sync Input Protection	+120 V/30 sec.	
Power Supply Protection	+25 V/15 sec.	
Output Protection	+35 V/15 sec.	
Operating Temperature	32° to 122°F (0-50°C) < 80% R.H/	
Storage Temperature	-4° to 149°F (-20° to +65°C), < 80% RH	
Dimensions	0.7 x 0.7 x 8.2" (18 x 18 x 210mm)	
Weight	1.4 oz. (40g)	
One Year Warranty		

20 MHz Logic Probe Model DP 21

- Tests TTL, and CMOS
- Displays pulse presence and logic states
- Memory mode "freezes" pulse display
- Catches pulses to 30ns or pulse trains to 20MHz
- 1 MΩ input impedance



DP 21

50 MHz Logic Probe Model DP 52

- Tests TTL and CMOS
- Displays DC to 50 MHz
- Detects 10ns pulse width
- Overload protected



DP 52

Pulser Probe Model DP 31A

- For TTL, and CMOS
- Produces 10mS pulse signal at 100mA
- External square wave terminal
- Sync input point



DP 31A

Specifications	models	
	DP 21	DP 52
INPUT CHARACTERISTICS		
Frequency response	DC to 20MHz	DC to 50MHz
Minimum detectable pulse width	30nS	10nS
LOGIC THRESHOLD		
TTL Logic 1 threshold (Red LED)	2.3V +0.2V	3.0V +0.25V
TTL Logic 0 threshold (Green LED)	0.8V +0.2V	0.75V +0.25V
TTL CMOS 1 threshold (Red LED)	70% Vcc + 10%	40% Vcc + 5%
TTL CMOS 0 threshold (Green LED)	30% Vcc + 10%	15% Vcc + 5%
PULSING	Yellow LED	Both Red and Green
INPUT OVERLOAD PROTECTION	+220Vac/DC (15 sec.)	+70Vac/DC (15 sec.)
INPUT IMPEDANCE	1MΩ	120kΩ
GENERAL		
Power supply protection	+20V	
Operating supply voltage	4 to 18V	
Storage temperature	-4° to 149°F (-20° to 65°C) <80% RH	
Operating temperature	32° to 122°F (0-50°C) <80% RH	
Dimensions (HxWxD)	0.7 x 0.7 x 8.2" (18 x 18 x 20mm)	
Weight	1.6oz. (45g)	
One Year Warranty		

Device Programmers



844USB



848A



866B

Common Features:

- Extensive Device Libraries
- Low Cost and High Performance
- Free Technical Support
- Easy-to-Use Windows® Operating Software

The 844USB and 866B are universal device programmers with extensive device libraries that are constantly updated. Each programmer has been designed for ease-of-use and reliable performance. Whether you are working with PLCC, SOIC, TSOP, DIP, TQFP, SSOP, PSOP or QFP B+K Precision has an extensive line of socket adapters to interface with any IC package. These programmers are a must for anyone that Tests, Repairs, or Programs any electronic device that uses a memory IC. The model 848A is great low cost programmer designed for anyone who wants to read, copy, program or burn common IC's. (Contact us for help in selecting the right programmer for your application)

Model 844USB

- USB 2.0/1.1 interface
- 40 pin DIL ZIF (Zero insertion force) socket accepts both 300/600 mil devices up to 40 pins
- Small fast and powerful programmer
- In-circuit serial programming (ISP) capability

Model 848A

- Low cost
- 32 pin DIL ZIF (Zero insertion force) socket accepts both 300/600 mil devices up to 32 pins
- Parallel printer port interface

Model 866B

- Fast programming speed (approximates shown below)
64-Mbit NOR Flash memory less than 50 sec.
1Gbit NAND Flash less than 220 sec.
- 48-pins powerful pin drivers, no adapter required for any <48-pin DIL devices
- Connector for in-circuit programming (ISP)
- Dual connections to PC: USB or parallel (printer) port
- USB 2.0/1.1 compatible interface
- Alternatively high-speed IEEE 1284 (ECP/EPP) printer-port (LPT) interface
- Easy to use Software compatible with: Windows® 98/Me/NT/2000/XP/2003/XPx64/Vista compatible
- Multiprogramming possibility by attaching more programmers to one PC
- Approved by CE laboratory to meet CE requirements

Specifications

	844USB	848A	866B	models
Devices Supported	EPROM, EEPROM/Flash, Serial EPROM, Microcontroller(844USB & 866B), PLD(844USB & 866B) and BPROM (BPROMs 866B)			
Device Library (as of 9-26-07)	>118393	>8383	>34115	
Interface	Standard Printer Parallel Port (Model 866B also has USB interface) 844USB has only USB port			
"Programming Socket .300-.600 pin spacing"	40 pin DIP ZIF	32 pin DIP ZIF	48 pin DIP ZIF	
Operating System	Windows® 95/98/Me/NT/2000/ XP/Vista compatible			
Buffer Features	Erase, Random Data Fill, Fill Block, Copy Block, Move Block, Swap Block, Buffer Print, Find Text, Replace Text, Go To Address, Checksum Calculator, 8 bit & 16 bit View Modes™			

One Year Warranty

Windows® is a trade mark for Microsoft corp

Device Programmers

Universal Multiprogrammer with 4 Programming Sockets

Model 859

The 859 is a universal multiprogrammer with 4 programming sockets with a constantly updated extensive device library. All four programming sockets are independent, and it has been designed for ease of use and reliable performance. It is ideal for use with laptop computers that do not have parallel port interfaces. Whether you are working with PLCC, SOIC, TSOP, DIP, TQFP, SSOP, PSOP or QFP, B+K Precision has an extensive line of socket adapters to interface with any IC package. This programmer is a must for anyone that tests, repairs, or programs any electronic device that uses a memory IC.

The easy-to-use control program with pull-down menu, hot keys and on-line help, also the 859 can be used by users with technical levels ranging from the hobbyist to the professional R&D Engineer. Selecting of device is performed by its class, by manufacturer or simply by typing a fragment of vendor name and/or part number.



Features:

- **Fast programming speed (64-Mbit NOR Flash >50 sec./1Gbit NAND Flash >220 sec.)**
- **Four Independent 48-pins powerful pin drivers, no adapter required for any <48-pin DIL devices**
- **Connector for in-circuit programming (ISP)**
- **Dual connections to PC: USB or parallel (printer) port**
- **USB 2.0/1.1 compatible interface**
- **Alternatively high-speed IEEE 1284 (ECP/EPP) printer-port (LPT) interface**
- **Easy to use Software compatible with: Windows 98/Me/NT/2000/XP/2003/XPx64/Vista compatible**
- **Expandable multiprogramming possibility by attaching two programmers to one PC**
- **Approved by CE laboratory to meet CE requirements**

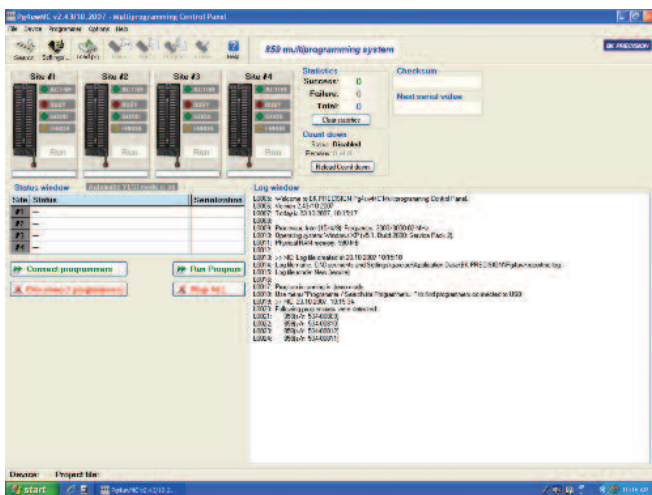

Device Programmers

Find out how to use 866B programmer in High Volume Production Application.

The 866B programmer is extremely fast and totally reliable universal programmer that support 29278 chips by actual version of software (Feb. 08, 2007).

The 866B programmer is basically intended as powerful engineering programmer, useable also as a single-site programmer in volume production.

What about multi-programmed and requirements for multiprogramming?

By operating multiple 866B programmers simultaneously you can use them in high volume production environment -in other words, using more 866B programmers you can get a universal, up to 8 programming sites multi-programmed with 48-pin DIP ZIF sockets, connects to PC by USB port. It is important to mention, there is a concurrent multiprogramming system - each programmer works independently and each programmer can program different chip, if necessary.

Benefits of the 866B multi-programming solution:

1. In general, the 866B multiprogramming system take advantage of all benefits of 866B programmer.
2. Model 866B programmer is a high performance universal programmer supporting 34115 chips and growing. We add new devices at a rate of about 4,000 devices/year and new software update is released monthly at least. Most gang programmers have limited number of supported devices, because they do not have



universal hardware. It also takes a very long time for device updates and the cost could be high. The abilities to add new devices for 866B multiprogramming system is as unlimited because of 866B's universal hardware and the software updates that are free of charge.

3. Model 866B programmer is extremely fast. It is faster than most gang programmers. Therefore, the multiprogramming solution based on the 866B programmer can program more chips in a day than a traditional gang multi-programmed.
4. Asynchronous (Concurrent) programming is more efficient than the synchronous (gang) programming of traditional gang programmers. In the concurrent multiprogramming mode each site operate independently. The programming starts as soon as a device is inserted into ZIF socket. Before the last device is loaded, the first device is already programmed and ready for removal. Operator is busy removing and inserting chips, so both the operator and programmer are running continuously at maximum efficiency. In a standard gang programmer, the operator is idle while chips are being programmed, and the programmer is idle while chips are being removed and new chips inserted. Therefore for the medium programming times you can easily do the job of an 8-gang programmer with 2-4 of 866B programmers.

Device Programmers

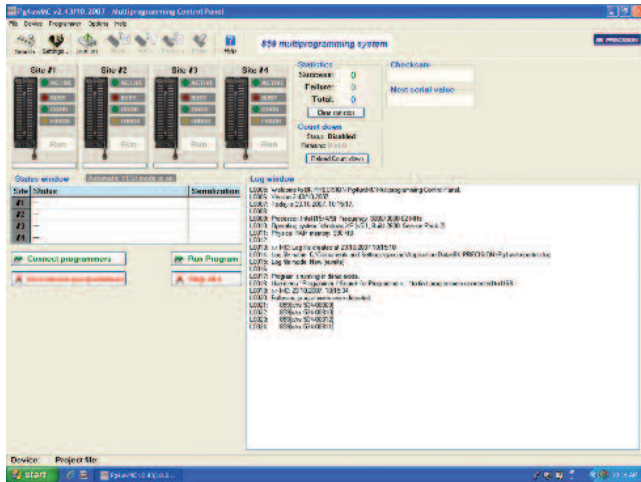

PG4UW Multi-programming control software

- 5. We provide a wide range of socket converters (programming adapters), therefore the full library of chips are available including special packages. Sockets with high pin counts can be supported, such as PLCC84, TQFP176, etc. Most gang programmers are designed with narrow spacing between sockets.
- 6. The special software (PG4UWMC = PG4UW Multiprogramming control) is available for controlling of the 866B programmers in the 866B multiprogramming mode. There is a project file to control

the 866B multiprogramming. The project file contains user data, chip programming setup information, chip configuration data, auto programming command sequence, etc. Therefore, operator error is minimized because the project files are normally designed and proofed by engineering and then given to the operator. The optional protected mode can be set for project file to avoid a unwanted changes of the project file.

- 7. PG4UW Multiprogramming control software is standard part of PG4UW software delivery.
- 8. Hands-free operation. Asynchronous (concurrent) operation allows a chip to begin programming immediately upon insertion of a chip. The operator merely removes the finished chip and inserts a new chip. Operator training is therefore minimized.
- 9. Service is easy. If one unit breaks down, the rest of the system is still running while having the defective unit serviced. You cannot do this with standard gang multi-programmers.

Deluxe EPROM Eraser

Model 851

The model 851 is a heavy duty EPROM eraser that can simultaneously erase up to 40 twenty-four pin EPROM's. It is constructed of an all-metal case plus an advanced designed chip drawer that prevents UV radiation from being a hazard to the user. The chip drawer is lined with conductive foam to prevent electrostatic damage to the chips.

- **Indicator light when erasing**
- **Power safety switch inside the drawer shuts off unit whenever the drawer is opened**
- **Large capacity**
- **One year warranty**



Specifications		model
	851	
Timer Setting	60 min.	
Timer Setting	100-120VAC 50/60Hz	
UV bulb wattage	10W	
Dimensions	15.5 x 6 x 3.25" (394 x 150 x 80mm)	
Weight	8.8 lbs. (4kg)	
Supplied	AC Power cord, Manual	
One Year Warranty		



1211E

NTSC Generator with RGB Model 1249B

The 1249B is ideal for comprehensive testing, servicing and adjustment of video and television equipment, television receivers, video tape recorders, video monitors, closed circuit television systems and components, and master antenna systems and components.

- **NTSC color bar pattern, ± 5 and ± 5 IEEE units**
- **CH 3, CH 4, and IF outputs crystal controlled**
- **Calibrated 1Vp-p or variable composite video output**
- **RGB outputs on BNC or 9-pin D connector**
- **Composite sync, vertical sync, and horizontal sync outputs**
- **Interlaced or progressive scan**
- **30 Hz signal is provided for isolation of servo problems in VCR's**

Portable NTSC Pattern Generator with S-Video, Composite Video and RF outputs

Model 1211E

This handheld NTSC Pattern Generator is powered by a 9 volt battery or an AC adapter, providing NTSC color bars, cross-hatch, dot, staircase, circle, center cross, windows, and a full range of color raster patterns. The outputs available are composite video via RCA connector, a RF output BNC connector, or an S-Video mini-DIN output. Signals can be produced as an interlaced or progressive scanning mode.

- **S-Video, composite video, RF output**
- **Interlace or progressive scanning system**
- **9VDC battery (included)**
- **AC adapter available**



1249B

Deluxe Pattern Generators

Specifications

	1249B	1211E models
Color Bars	White (75% or 100%, switch selectable) Yellow, Cyan, Green, Magenta, Red, Blue, Black (7.5% set-up)	White, Yellow, Cyan, Green, Magenta, Red, Blue, and Black
Chroma	Switch Selectable	Auto/Manual
Accuracy	$\pm 5^\circ$ and ± 5 IEEE	
Staircase	COLOR OFF obtains staircase from color bars	Linear staircase signal with 5 equal steps from black to white
Rasters	Black	White, Red, Green, Blue, Yellow, Cyan, Magenta, and Black
Window	Does not apply	White window on black background
Convergence	Center dot	15 vertical x 11 horizontal
	7x11 dots	white dots on black raster
	7x11 crosshatch	white lines on black raster
	Center Cross	Centering Box on screen
		Circle with 1x1 crosshatch
RF Output	Channels: CH 3, CH 4, IF 61.25, 67.25, 45.75 MHz ± 0.008 MHz	CH3 = 61.25MHz, crystal controlled
Level	10 mV rms minimum into 75 Ω	
Impedance	75 Ω	75 Ω
Stability		50 ppm.
S-Video	Does not apply	Chrominance Output: 0.75V p-p into 75 Ω Luminance plus Sync Output: 1V p-p into 75 Ω
Composite Video	1V p-p into 75 Ω Negative or positive polarity sync available	1.2V p-p into 75 Ω
Amplitude	Variable 0 to $\pm 1.2V$ p-p into 75 Ω Calibrated 1V p-p position with negative sync.	
Impedance	75 Ω	
RGB Output		
Patterns	BNC and D-Type Sub-Miniature Connectors. convergence and color bars	Does not apply
Level	TTL level and low level, (0.8 \pm 0.2V), switch selectable	
Impedance	75 Ω	
Sound	4.5 MHz $\pm 0.2\%$ modulated by approximately 1 kHz audio tone, switch selectable	
Sync Outputs		
Composite	NTSC-M TTL level; interlace for NTSC color bars and switch selectable interlace or progressive for convergence patterns (negative polarity sync)	Does not apply
Horizontal	TTL level (Positive polarity sync.)	
Vertical	TTL level (Positive polarity sync.)	
Impedance	75 Ω	
Color Subcarrier	NTSC signal: 3.579545 MHz (+50Hz)	
Power Source	105 to 130VAC, 60Hz, 8W	9V battery or AC Adapter (not included) (9V DC, 100mA 5.5mm x 2.5mm center pin)
Operating Temperature	32 $^\circ$ to 122 $^\circ$ F (0 $^\circ$ to +50 $^\circ$ C)	
Dimensions	3.39 x 10.39 x 11.42" (86 x 264 x 290mm)	1.5 x 3.8 x 5.7" (38 x 97 x 145mm)
Weight	2.8 lbs (1.3kg)	9.6oz. (272g)

Accessories

One Year Warranty

SUPPLIED: instruction Manual, 9V battery (1211E)
OPTIONAL: BE 12 AC adapter

For more product information please visit www.bkprecision.com

121

Video Monitor Testers



1275



Features	1280A	models 1275
Color Bars	✓	✓
Black Raster	✓	✓
Color Rasters	✓	✓
Window	✓	✓
Dot	✓	✓
Crosshatch	✓	✓
Multiple Outputs	✓	
RGB	✓	
H/HV Sync	✓	
V Sync	✓	
Auto/Manual	✓	✓
Gray scale	✓	
Available Patterns		
PC: 1280 x 1024	✓	✓
1024 x 768 (non-interlaced)	✓	✓
841 5A (interlaced)	✓	✓
SVGA 800 x 600	✓	✓
SVGA 1024 x 768	✓	✓
VGA 640 x 480	✓	✓
VGA 640 x 350	✓	
VGA 720 x 400	✓	
EGA	✓	✓
CGA	✓	✓
MDA	✓	
Mac: 1280 x 1024	✓	
1152 x 870	✓	
1024 X 768 (non-interlaced)	✓	
832 x 624	✓	
640 x 480	✓	✓
512 x 384	✓	
Power Source	9V battery or AC adapter	
Dimensions	3.125 x 9.44 x 9.25" (78 x 240 x 235mm)	1.5 x 3.8 x 5.7" (38 x 97 x 145mm)
Weight	2.5lbs. (1.1kg)	0.5 lbs. (227g)

Accessories	One Year Warranty	
SUPPLIED:	BE 12 AC adapter	9V battery
OPTIONAL:		BE 12 AC adapter



1280A

Benchtop Computer Monitor, PC & Mac, Video Tester

Model 1280A

The 1280A is a fully featured bench-top design to test both Mac and PC monitors. All patterns can be manually selected or place the 1280A in Auto for automatic cycling of each available pattern. Designed to test (burn-in) one to four monitors, the 1280A can also be used as a display generator. Full color, green, blue, red, black and white.

- PC and Mac Patterns
- 16 Monitor Types/Resolution Selections
- Color bar, Cross Hatch, Dot, Raster, Windows® selection
- VGA, SVGA, RGB, HV, V & Four DB-15 (Rear panel) for multiple monitor burn-in

Portable Video Pattern Generator

Model 1275

Great handheld unit to test PC and Mac monitors. The model 1275 is ideal for the field or the service bench. Small, portable and very effective, the 1275 generates crosshatch, dots, color bars and raster patterns in green, blue, red, black and white.

- CGA, VGA, SVGA
- Standard DB-9, DB-15 and DB-15 Hi-res mini connectors

Video Testers

HDTV Pattern Generator

Model 1253

B&K Precision's model 1253 is an affordable HDTV test pattern generator that delivers accurate test patterns for the testing of the most common HDTV displays including Plasma, LCD, TFT, CRT, DLP, GLV and OLED digital display products. The 1253 can display from its HDTV Component (YPbPr) outputs or S-Video output(Luminance patterns only), fourteen of the most useful patterns for twelve of the most commonly used video formats. It is lightweight and portable and is ideal for on-the-bench and in-the-field testing. The 1253 is a must have tool for TV repair engineers or technicians to test and calibrate digital televisions, for video engineers to test and maintain studio equipment or Home Theater Installation technicians to fine-tune the picture quality of digital televisions. The 1253 displays the most popular formats including 1920 x 1080 30i, 1280 x 720 60p, 704 x 480 60p, NTSC, PAL & SECAM. A unique feature of the 1253 is the Overscan DVD Aspect Ratio pattern. This feature covers the most commonly use aspect ratios used for all movies recorded to DVD media.



Specifications		model
		1253
Video Formats	1	1920x1080 30i
	2	1920x1080 30p
	3	1920x1080 24p
	4	1280x720 60p
	5	1280x720 30p
	6	1280x720 24p
	7	704x480 60p
	8	704x480 30p
	9	704x480 30i
	10	*NTSC
	11	*PAL
	12	*SECAM
Patterns	1	SMPTE Bars [75%, 100%] (power up default is 75%)
	2	PLUGE
	3	Needle
	4	Color Bars [75%, 100%]
	5	Cross Hatch [16:9, 12:9(4:3)]
	6	DVD Aspect Ratio [1.33:1, 1.78:1, 1.85:1, 2.35:1]
	7	Raster [75% wht, yel, cyn, grn, mag, red, blu, blk]
	8	Multiburst
	9	Focus
	10	Staircase
	11	ANSI Gray
	12	Window [2.5 IRE steps from Black to White]
	13	Checker
	14	Overscan - Bounce
Operation	15 buttons, 1 Power Switch	
Y Output	1V peak-to-peak into 75 ohms, on BNC	
Pb, Pr Outputs	0.7V peak-to-peak into 75 ohms, on BNC	
S-Video (SVHS)	5 Pin Din	
Video Output Buffer Response	100MHz @ -3dB	
Power Supply	9V Alkaline Battery	
Power Indicator	Red LED	
Timing Accuracy	25ppm (0.0025%)	
Video Level error	< 1.5%	
Size (LxWxD)	5.6" x 3.1" x 1.1" (142 x 79 x 28mm)	
Weight (Approx.)	6.2 oz (176 g)	
Accessories		One Year Warranty
SUPPLIED: instruction Manual, 9V battery, carrying case, output cables		
* S-Video output provides luminance patterns only		

GENERATED PATTERNS



Color Bars



DVD Aspect Ratio



Multiburst



PLUGE



SMPTE Bars



Staircase

Multi-Network Cable Testers

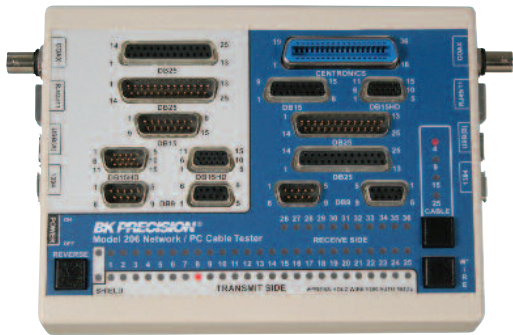

Network/PC Cable Tester Model 206

This cable tester is a stand-alone test device. It is designed to test popular PC data cables, printer, monitor, modem, mouse extension, game, BNC coax, RJ45, 1394, and USB cables by identifying the wire connection status: open, short, cross, miswire, and continuity of wires and pin configuration. It is a very good tool for most cable dealers, cable assembly house or system integrator to quickly check the pin configuration or troubleshooting in every work environment.

- Tests most PC data cables and network cables, such as printer, monitor, modem, mouse extension, BNC coax, RJ45, 1394, and USB cables
- Detects open, short, miswire, continuity, game, and pin configuration
- Ideal for: cable dealers, cable assembly house or system integrators
- Quick and easy to use
- LED display for easy identification
- Auto and manual modes
- Reverse test

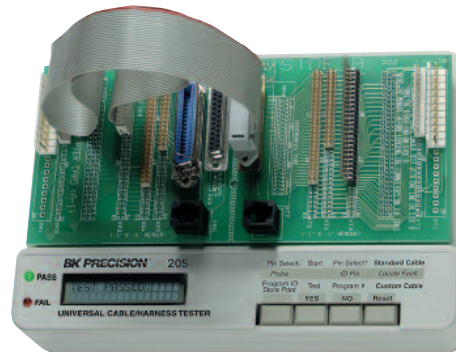

Universal Cable Tester Model 205

The B-K Precision Model 205 Universal Cable / Harness Tester tests just about any cable or harness in fractions of a second. It is a compact, stand-alone unit that can be used for any type of wired assembly. Opens, shorts and miswires are detected immediately. The universal adapter card offers outstanding flexibility and convenience, ready to accept any of the industry's 22 most popular connector styles. A crisp, easy-to-read LCD instantly indicates good or faulty connections and the included probe pinpoints the trouble spot.

- Detects opens, shorts and miswires
- Test up to 128 points in a fraction of a second
- Universal Adapter Card accepts most popular connectors
- Includes single wire test probe
- Stores up to 50 test programs
- Printer interface for wire listing
- Spare PCB test board assemblies optional (205-PCB)

Accepts These Connectors			
	model 205		
Interface	Spacing/Style	Connector	Maximum
8	0.1"	Dual-Row	64
2	"D" Subminiature	Dual-Row	37
2	Delta	Centronics	80
2	0.6"	DIP	40
2	RJ11	Phone Plug	6
2	PJ45	Phone Plug	8
2	0.156" Header	Single-Row	20
2	0.1" Header	Single-Row	32

Specifications

	205	206	models
Power Source	AC/DC adapter (included)	9V Battery	
Dimensions (HxWxD)	2.1 x 13.8 x 9" (53 x 351 x 229mm)	1.65 x 8.55 x 5.5" (42 x 217 x 140mm)	
Weight	3lbs. (1.4kg)	1.3lbs. (590g)	
Standard Accessories	one single wire test probe with standard banana jack, Manua, AC/DC adapter, one adapter card	Manual, Battery	
Optional Accessories	Extra adapter card		
	Three Year Warranty	One Year Warranty	

Cable Testers



231A



230A

Multi-Network Cable Tester Model 230A

The 230A tests thin Ethernet (BNC), 10BaseT (UTP/STP), 100BaseTx, RJ45, TIA-568A, TIA-568B, and Token Ring cables within a few seconds. It detects miswiring, polarization, and continuity. The 230A also tests the ground of shielded twisted pair cables. With the remote unit, you can remotely test installed cable either from the wall plate or patch panel.

- Auto scans thin Ethernet (BNC), 10Base T (UTP/STP), 100BaseTx, RJ45, 356A, TIA-568A, TIA-568B, and Token Ring cables in seconds
- Detects miswiring, polarization, and continuity
- Also tests the ground of shielded twisted pair cables
- Tests cables before or after installation with the remote unit
- LED display for clear indication of problems
- Protective rubber boot
- Belt clip

Specifications

	230A	models 231A
Cable Type		
10BaseT	✓	✓
10Base2	✓	✓
100BaseTx	✓	✓
RJ45	✓	✓
RJ11		✓
356A		✓
TIA-568A	✓	✓
TIA-568B	✓	✓
Token Ring	✓	✓
Test Type		
Open	✓	✓
Short	✓	✓
Reverse	✓	✓
Cross	✓	✓
Split		✓
Power Source	9V Battery	9V Battery
Dimensions (HxWxD)	5.4x3x1.6" (137 x 76 x 40mm)	5.2x3x1.6" (132 x 76 x 40mm)
Weight	6.8oz. (193g)	7.1oz. (201g)

Accessories

One Year Warranty

SUPPLIED:	230A	231A
	Master Unit Remote Terminator	Master Unit Remote Terminator 3 Patch Cables BNC to BNC adapter

Deluxe Multi-Network Cable Tester Model 231A

The 231A can easily read the correct pin configuration of 10BaseT cable (category 5), 100BaseTx, 10Base2 cable (coax) and RJ45/RJ11 modular cables, 356A, TIA-568A, TIA-568B and Token Ring cables by comparing one transmitting end to the corresponding receiving end. With the remote kit, it can test cables installed far away either on wall plate or patch panel up to 1000ft away. It is easy to verify the cable continuity, open, short, and cross connect, featuring auto or manual scan for pin-out indicators.

- Tests 10BaseT, 100BaseTx, 10Base2, RJ45, RJ11, 356A, TIA-568A, TIA-568B, and Token Ring cables
- Detects open, short, cross, and continuity
- Tests Point-to-Point, rather than Pair-to-Pair
- Quick and easy to use
- Tests cables on wall plate or patch panel up to 1000 ft away with the remote kit
- Easy to read LED display
- Protective rubber boot
- Belt clip

Cable Testers

Cable Tracer Probe Model 261

The model 261 is light weight, hand-held, battery-powered Cable Tracer. The product portability, flexibility, and low cost make it the ideal tool for every cabling technician.

The Model 261 Cable Tracer is a hand-held inductive tracer that will help to identify wires without piercing the



insulation. It features a Hi-gain, Hi-impedance amplifier and is capable of identifying tones from a distance of up to 12 inches. It can trace Tone Generator signals through dry wall, wood and many other non-metal surfaces (under ideal conditions) and features a rugged, moisture resistant Mylar cone speaker.

- **Hi-gain, Hi-impedance amplifier**
- **Capable of identifying tones up to 12 inches away (under ideal conditions)**
- **Rugged, moisture resistant, Mylar cone speaker**
- **Dimensions (H x W x D): 7.37" x 1.87" x 1.12" (187.1 x 47.5 x 28.4 mm)**
- **Weight: 4.9 oz. (138.9 g)**
- **Power: Standard 9-volt battery**
- **One Year Warranty**

Tone Generator and Cable Tracer Kit Model 262



Tone Generator:

The Tone Generator is a hand-held, battery-powered instrument designed to perform a variety of tests on un-energized telephone lines or LAN cables. Alligator clips and a standard RJ11 plug allow the tone generator to be connected to stripped wires, terminal panels, wall plates, or modular single line jacks.

Cable Tracer:

The Line Tracer is a hand-held inductive tracer that will help to identify wires without piercing the insulation. It can trace Tone Generator signals through dry wall, wood and many other non-metal surfaces.

Features

Tone Generator:

- **Generates Warbled Tone with selectable test frequencies**
- **LED indicates continuity when in CONTINUITY mode**
- **LED indicates positive polarity when in POLARITY mode**
- **Provides talk current on a dead line**
- **Check line Polarity**

Cable Tracer:

- **Hi-gain, Hi-impedance amplifier**
- **Capable of identifying tones up to 12 inches away (under ideal conditions)**
- **Rugged, moisture resistant, Mylar cone speaker**

Specifications		model
	262	
Tone Generator		
Tone Output Level	Approximately 8 vp-p (+3dBm, 600W).	
Tone Output Current	Approximately 4 mA	
Tone Frequency	1.4KHz to 1KHz or 0.84KHz to 0.7KHz with switching freq. of 14Hz or 7Hz	
Continuity / Talk Test	35mA (leads shorted), approximately 6.5 VDC (leads open)	
Dimensions (H x W x D)	7" x 1.87" x 1.12" (177.8 x 47.5 x 28.4 mm)	
Weight	5.8 oz. (164.4 g)	
Power	Standard 9-volt battery	
Cable Tracer		
Dimensions (H x W x D)	7.37" x 1.87" x 1.12" (187.1 x 47.5 x 28.4 mm)	
Weight	4.9 oz. (138.9 g)	
Power	Standard 9-volt battery	
One Year Warranty		

Telephone Product Tester



Telephone Product Tester Model 1045B

- Provides basic operation tests for corded and cordless telephones, answering machines, fax machines and automatic dialers
- Checks line and handset cord for continuity, shorts and intermittents
- Verifies number dialed or redialed (pulse or Touch Tone®)
- Verifies that voice and DTMF levels are above minimum required level
- Provides low and normal ring tests
- Tests two-line phones
- Tests automatic polarity circuit in telephone, assuring that telephone will work if polarity of telephone is reversed

U.S. Patent Number 4,577,072

Specifications

	1045B	model
Telephone Line Simulation	Single or two telephone operation	
DC Line Voltage	52V ± 15%, 1.5kΩ source impedance	
Current	28 mA nominal (off hook)	
Auxiliary Line Voltage	5 to 7 VAC, 60 Hz to operate light in telephone	
Polarity Test Switch	Reverses telephone line polarity with momentary switch	
Single/Aux (Two-Line) Switch	Permits testing two-line telephones	
Voice/Dial Level Indicator	illuminates for levels greater than 0.1V	
Ring Source	Frequency: 20Hz, Accuracy: ± 1% Voltage (2 select level): Low - 45Vrms ± 5%, Normal - 100Vrms ± 5%	
Cord Tests	Tests both telephone line and handset 2-wire and 4-wire modular cords for shorts or continuity	
Reset	Sets display to "0" and removes dial tone when activated Shuts off ring signal when activated	
Operating Temperature	32° to 113°F (0° to 45°C)	
Power	100/120/220/240 VAC +10%, 50/60 Hz, 25W	
Dimensions (HxWxD)	3.7 x 9.6 x 11.0" (95 x 245 x 280 mm) including handle at rest position	
Weight	4.4 lbs. (2 kg)	

Touch Tone® is a registered trademark of AT&T

One Year Warranty



DTMF Test

Environmental

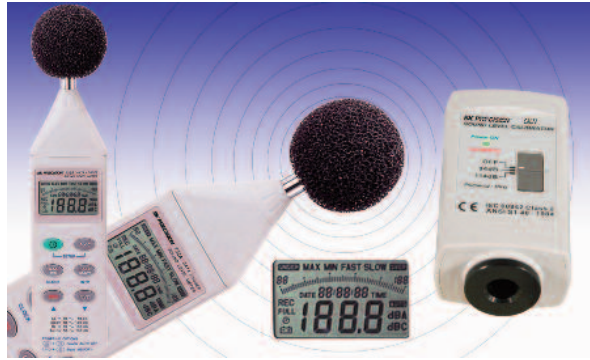

SELECTION GUIDE

	Description	Model	Page
pH Meters	Intelligent pH meter with probe	760KIT	129
	Deluxe Intelligent pH Meter with Access.	760DX	130
	Intelligent pH Meter	760	130
Humidity Temperature	Datalogging Humidity/Temperature Meter w/ Dual Input	725	131
	Humidity/Temperature Meter w/ Dual Input	720	131
Digital Thermometer	Temperature Meter	710	132
	Datalogging Temperature Meter	715	132
	Compact Digital Thermo-Hygro Meter	625	133
	K-type Thermocouple Compact Digital Thermometer	630	133
	Compact Digital Infrared Thermometer	635	133
	Non-Contact Infrared Thermometer with Laser Pointer	636	132
Light Meter	Compact Digital Lightmeter	615	134
Carbon Monoxide	Carbon Monoxide Meter	627	134
Air Velocity & Sound Meter	Sound Meter	732A	135
	Sound Level Meter	735	135
	Precision Anemometer	731A	135
	Standard Acoustic Calibrator	CAL73	135

Intelligent pH Meter w/ Probe Model 760KIT

- pH meter with mV measurement
- RS-232 PC Interface
- Plug and Play function
- pH Probe

Model 760 is a hand-held, battery-powered multifunction pH, mV/ Temperature instrument that is PC compatible and can be used in the laboratory as well as in the field. Using 9VDC battery as the power source, the new portable meter has an easy-to-read LCD display and the ability to accurately measure pH (0 to 14 pH) mV (-1999mV to 1999mV) and Temperature compensation for pH measurement (0° to 100°C). Model 760 is an ideal tool for measuring the quality and characteristics of liquid.



Specifications		model
		760KIT
pH Probe		
Applications		High quality, Professional, laboratory & field usage.
Measuring Range		0 to 14 pH
Measuring Temp		0 to 100°C (32° to 100° F)
Electrode Structure		Combination type.
Zero Potential for		71 pH
pH Value		
Body Material		Epoxy
Connector		BNC
Mechanical		With protection bottle on the electrode head
Protection		electrode head
Dimensions		Body Length - 120 mm
Body Dia		9.5 mm
Cable Length		750 mm
One Year Warranty		

Specifications			
	Range	Resolution	Accuracy
pH Meter			
Measurement	Range	Resolution	Accuracy
pH	0 to 14 pH	0.01 pH	± (0.02 PH + 2 dgt)
mV	0 to 1999 mV	1 mV	± (0.5% + 2 dgt)

- * pH accuracy is based on calibrated meter only.
- * Specification tests under the environment RF Field Strength less than V/M & frequency less than 30 MHz only.

Some of the unique features of the B+K Precision Model 760 include:

- pH/mV meter with "Plug & Play" function.
- pH range: 0 to 14 pH x 0.01 pH MV range: -1999 mV to 1999mV.
- **Optional Probes**
Conductivity Probe (760CP)
Dissolved Oxygen Probe (760DOP). After connecting a new probe, no new calibration procedures are required. "Plug & Play" function, ATC (Auto Temperature Compensation) probe is available for pH measurement.
- mV function for mV measurements.
- Wide manual temperature compensation adjustment
- Microprocessor circuit assures high accuracy and reliable performance.
- Large LCD, dual function display.
- Records Maximum and Minimum readings with recall.
- Data Hold.
- Auto shut off saves battery life.
- Powered by 9VDC battery.
- RS-232 PC serial interface.
- Front panel buttons control °C or °F conversion and pH calibration
- pH function with high input impedance avoids measuring errors.

Environmental

Deluxe Intelligent pH Meter with Accessories

Model 760DX

Model 760DX includes the pH probe, ATC probe, Dissolved Oxygen probe, Conductivity probe, W/RS-232 cable and software, and a protective carrying case.

The accessories below are included with the 760DX:

Intelligent pH meter

Model 760

760 is a hand-held, battery-powered multifunction pH, mV/ Temperature instrument that is PC compatible and can be used in the laboratory as well as in the field. Using 9VDC battery as the power source, the new portable meter has an easy-to-read LCD display and the ability to accurately measure pH (0 to 14 pH) mV (-1999mV to 1999mV) and Temperature compensation for pH measurement (0 to 100°C).

- pH Meter with mV and "plug and play" function.
- pH (0.00 to 14.00 pH), mV (± 1999 mV).
- manual temp. compensation adj. or ATC via the optional temp. probe (760 ATC).

Dissolved Oxygen Probe

Model 760DOP

- Plug in the 760 to be a professional Dissolved Oxygen Meter.
- Range: 0 - 20.0 mg/L, 0.1 mg/L.
- With automatic temperature: 0 - 50.0 °C, 0.1 °C/0.1 °F.
- Diaphragms & electrolyte included.

ATC Probe

Model 760ATC

- Plug in the 760 to be a ATC (Automatic Temp. Compensation) probe to gain the Max. possible accuracy.
- Temperature range: 0 to 65 °C, 32 to 149 °F.

pH electrode

Model 760pH

- Plug in the 760 to be a pH electrode Meter.
- Range: 0 to 14 pH
- Measuring Temp.: 0°C to 100°C

Conductivity Probe

Model 760CP

- plug in the 760 to be a professional Conductivity Meter,
- Conductivity : 2/20 mS, 2 ranges
- Temperature : 0 to 60.0 °C/0.1 °F.
- ATC & variable temp. compensation factor adjustment (0 to 5.0% per °C).

Software w/RS-232 Cable

Model AK 760

- For Windows® 95 & 98
- Data logging system, data recorder

Protective Carrying Case

Model LC 760

- Dimensions (HxWxD): 2.75" x 15" x 10"



Model 760



Model 760DOP



Model 760ATC



Model 760pH



Model 760CP



Model AK 760



Model LC 760

Humidity Temperature Meters

Datalogging Humidity/Temp Meter w/ Dual Input

Model 725

Humidity/Temp Meter w/ Dual Input

Model 720

State of the art dual function meters with two environmental sensors housed in a remote wand. The sensors can be placed right where they are needed. Both meters feature triple LCD displays, RH and temperature readings simultaneously, and a second K-type thermocouple port.

Model 725 has datalogging feature and records up to 16,300 data points. With an adjustable interval setting, you can record from 4 hours to 678 days worth of data. Both units feature RS-232 output ports (software optional on Model 720). Either download data for analysis or control the meter in real-time from your PC. With the optional TestLink software and RS-232 cable (AK 720), even Model 720 becomes a real-time datalogging meter when attached to a PC. These meters are ideal for environmental testing, lab monitoring, process control and building maintenance.

Additional features include:

- Tripod Mounting Lug
- Auto Power Off
- Real Time Clock (Model 725)
- Relative Function (Model 720)
- Min/Max function



Tripod Mountable
(tripod not included)



**Easy to read -
Triple Display**



725

720

Specifications

models

	720 & 725
Measurement Range	
Humidity	0%~100% RH
Temperature	T1: -4°~140°F (-20°~60°C) (K-type) T2: -328°~2,498°F (-200°~1,370°C)
Resolution	0.1% RH 0.1°F (0.1°C)
Accuracy	
Humidity	±2.5% RH (@77°F/25°C, 30~95% RH)
Temperature	1.4°F (±0.7°C) (K-type) ±0.3%rdg+2°F (±0.3%rdg+1°C)
Sensor Type	Humidity: Precision capacitance sensor Temperature: T1: Semiconductor sensor T2: K-type Thermocouple
Response Time	Humidity: 75 s (in slow moving air) Temperature T1: 40 sec
Sample Rate	1 time per second
Record (Datalogging)	16,300 Points (Model 725)
Datalogging Interval	00m:01s to 59m:59s (Model 725)
Operating Temp. & Humidity	32°~122°F (0°~50°C) & 0~90% RH Non-condensing
Storage Temp. & Humidity	14°~140°F (-10°~60°C) & 0~80% RH Non-condensing
Power Supply	9V NEDA 1604 Battery (Optional adapter BE-9)
Battery Life	Approximately 100 hrs (Alkaline)
Dimensions (LxWxH)	10.63 x 2.68 x 0.99" (270 x 68 x 25mm)
Weight	Model 725: 2.4 lbs. (930g), Model 720: 1.8 lbs. (820g)

Accessories

One Year Warranty

SUPPLIED:	Model 725 : Datalogging meter, Instruction manual, Battery, Carry case, PC Software, RS-232 Cable, and K-type Bead Probe Model 720 : Meter, Instruction manual, Battery, Padded pouch, and K-type Bead Probe
OPTIONAL:	BE 9 AC Adapter, AK 720 TestLink Software w/RS232 Cable (Model 720) See page 134 for K-type Thermocouple Probes

Dual Input Digital Thermometers

Temperature Meter Model 710

Datalogging Temperature Meter Model 715

Two fully functional, highly accurate meters offer dual K-type thermocouple inputs, RS-232 output port, and large LCD displays. Model 715 datalogging meter provides a triple LCD display that shows T1, T2 and T1-T2 simultaneously. The unit can log up to 16,000 data points with an adjustable interval. Model 710 offer a dual display where T1 and T2 can be switched between the large and small digits. While T1 - T2 is displayed on the large digits, T1 and T2 alternate on the small digits. With the optional ThermoLink software and RS-232 cable (AK 710), even Model 710 becomes a real-time datalogging meter when attached to a PC.

Common Features:

- Max/Min
- Data Hold
- °C/°F readings
- Auto Power Off
- RS-232 output ports

(Model 715)

- Triple display
- Datalogging RS-232 port w/ cable and software
- Time reading
- AC adapter port

(Model 710)

- Dual display
- RS-232 port
- ΔRel Function
- Avg/Max/Min readings
- T1, T2 & T1-T2 select
- AC adapter port



Model 710 Dual-Display



710

715

Specifications

	models	
	715	710
Measurement Range	-328° ~ 2,498°F (-200° ~ 1,370°C)	
Resolution	0.1°F (0.1°C)	
Accuracy	±0.2%rdg + 2°F (±0.2%rdg + 1°C)	
Sensor Type	K-type thermocouple	
Input Protection	60V DC or 24V rms AC Maximum	
Sample Rate	1 time per second	
Record (Datalogging)	16,000 Points	Does not apply
Datalogging Interval	00m:01s to 59m:59s	Does not apply
Operating Temp. & Humidity	32° ~ 122°F (0° ~ 50°C) & 10~80% RH	
Storage Temp	-4° ~ 140°F (-20° ~ 60°C)	
Power Supply	9V NEDA 1604 Battery (Optional Adapter BE-9)	
Battery Life	Approximately 100 hrs (Alkaline)	
Dimensions (LxWxH)	7.24 x 2.52 x 1.18" (184 x 64 x 30mm)	
Weight	11.3 oz. (320g)	1.66 lbs. (760g)

Accessories

One Year Warranty

SUPPLIED: Instruction manual, Battery, 2 Bead Probes and Large carry case, Battery, 2 Bead Probes and Small carry pouch.

OPTIONAL: BE 9 AC Adapter, AK 710 Thermolink Software w/RS-232 Cable (Model 710)
See page 87 for K-type Thermocouple Probes

Non-Contact Infrared Thermometer with Laser Pointer

Model 636

The 636 is a portable, easy to use, 3 1/2 digit, compact sized infrared digital thermometer with laser pointer, designed for simple one hand operation. The meter comes with a Back lit LCD display. Auto hold function and auto power down (10 seconds approx.) after releasing the Trigger to extend battery life.

Trigger to extend battery life.

- Bright back lit LCD
- Laser pointer
- Reading hold
- Adjustable emissivity
- Wide temperature range of -22 to 1022 °F



Specifications

	model
	636
Measurement Range	-22°F to 1022°F / -30°C to 550°C
Resolution	1°F, 0.5/1°C
Accuracy	±(4°F/2°C) for -22°F to 212°F, -30°C to 100°C ±(2% of reading) for 213°F to 1022°F, 101°C to 550°C"
Response Time	0.25 second (approx.)
Spectral Response	6 to 14μm nominal
Emissivity	0.1 to 1.0
Field of View	1000Ømm at 1000Ømm
Detection Element	Thermopile
Operating Temp. & R.H.	32°F to 122°F (0°C to 50°C) at <70% R.H.
Storage Temp. & R.H.	-4°F to 140°F (-20°C to 60°C) at <80% R.H. (with battery removed)
Power Supply	Standard 9V battery (NEDA 1604, IEC 6F22 006P)
Battery Life	9 Hours (continuous) typical
Dimensions (HxWxD)	5.8 x 4.1 x 1.65" (148 x 105 x 42mm)
Weight	157g including battery (approx.)

Digital Thermometers



625



630



635

Compact Digital Thermo-Hygro Meter

Model 625

The 625 is a portable 3 1/2 digit, compact-sized digital Thermo-Hygrometer designed for simplicity and one hand operation. It can measure and display an environment temperature and humidity in a fraction of a second.

- Backlight
- Display Hold
- Max. Hold

K-type Thermocouple Compact Digital Thermometer

Model 630

The 630 is a portable 3 1/2 digit, compact-sized dual input digital thermometer designed to use external K-type thermocouples as temperature sensors. This unit can display the temperature difference between it two inputs.

- Backlight
- Display Hold
- Max. Hold

Compact Digital Infrared Thermometer

Model 635

The 635 is a portable easy to use 3 digit, compact sized infrared digital thermometer with laser pointer, designed for simple one hand operation. Meter comes with Backlit LCD display, Auto-hold function and auto power down (20 seconds approx.) after releasing MEAS button to extend battery life.

- Laser pointer
- Reading Hold
- Adjustable Emissivity

Specifications

	model
	625
Measurement Range	Temperature: 32° to 140°F (0° to 60°C)
Humidity	0% to 100% RH.
Resolution	Temperature: 0.1°F/C Humidity: 0.1% RH
Basic Accuracy	Temperature: +1°F/C Humidity: +2.5% RH
Sensor Type	Temperature: Thermistor Humidity: Electronic capacitance polymer film sensor
Sample Rate	2.5 times per second
Operating Temp. & Humidity	32° to 131°F (0° to 55°C), at < 75% RH
Storage Temp. & Humidity	-68° to 131°F (-20° to 55°C), 0 to 80% RH with battery removed
Power Supply	9V battery
Battery Life	> 200 hours typical
Dimensions (HxWxD)	7 x 2.6 x 1.4" (178 x 65.5 x 35mm)
Weight	6.0 oz. (170g)

One Year Warranty

Specifications

	model
	630
Measurement Range	-58° to 2000°F (-50 to 1300°C)
Resolution	1°F/°C, 0.1°F/°C
Basic Accuracy	+(0.3% rdg + 1°)
Sensor Type	K-type thermocouple
Sample Rate	2.5 times per second
Operating Temp. & Humidity	32° to 104°F (0° to 40°C), at < 70% RH
Storage Temp. & Humidity	-4° to 140°F (-20° to 60°C), 0 to 80% RH with battery removed
Power Supply	9V battery
Battery Life	> 200 hours typical
Dimensions (HxWxD)	6.1 x 2.6 x 1.4" (156 x 65.5 x 35mm)
Weight	7.05 oz. (200g)

One Year Warranty

Specifications

	model
	635
Measurement	Range -4° to 1022°F (-20° to 550°C)
Resolution	1°C/F
Accuracy	+2% of reading or +6°F (3°C), whichever is greater
Spectral Response	6 to 14μm
Emissivity	0.10 to 1.00 by steps of 0.01
Field of View	2.5" Ø at 39" (65mmØ at 1000mm)
Sample Rate	1 time per second
Operating Temp. & Humidity	32° to 122°F (0° to 50°C), at < 70% RH
Storage Temp. & Humidity	-4° to 140°F (-20° to 60°C), 0 to 80% RH with battery removed
Power Supply	9V battery
Battery Life	> 200 hours typical
Dimensions (HxWxD)	6.7 x 2.6 x 1.4" (170 x 65.5 x 35mm)
Weight	6.7 oz. (190g)

One Year Warranty

Environmental

Compact Digital Lightmeter

Model 615

This instrument is a portable easy to use 3 1/2 digit, compact sized digital lightmeter designed for simple one hand operation. It provides measurement in lux and fc units. The meter has a backlit LCD display, PEAK-HOLD (50mS pulse light) and DATA-HOLD feature.

- Peak Hold
- Display Hold



Specifications		model
	615	
Measurement Range	20lux to 20klux, 20fc to 20kfc	
Resolution	0.01lux, 0.01fc	
Accuracy	+(3%rdg + 10dgt)	
Spectral Response	CIE photopic	
Sample Rate	2.5/sec.	
Operating Temp. & Humidity	32° to 122°F (0° to 50°C), at < 70% RH	
Storage Temp. & Humidity	-4° to 140°F (-20° to 60°C), 0 to 80% RH with battery removed	
Power Supply	9V battery	
Battery Life	> 200 hours typical	
Dimensions (HxWxD)	7.5 x 2.6 x 1.4" (190 x 65.5 x 35mm)	
Weight	7.76 oz. (220g)	
One Year Warranty		

Carbon Monoxide Meter

Model 627

- CE-Mark Approval.
- Portable and simple one hand operation.
- Display Back-Light.
- With MAX/DATA HOLD function.
- Hand-Held lightweight design.
- Wide CO measuring range of 0 to 1000PPM



Specifications		model
	627	
Display	3 1/2 digit liquid crystal display (LCD) with a maximum reading of 1999.	
Polarity	Automatic, positive implied, negative polarity indication.	
Zero	Automatic.	
Low battery indication	Displayed when the battery voltage drops below the operating level.	
Operating environment	32 to 105°F (0°C to 50°C) at <75% relative humidity.	
Storage temperature	-4° to 140°F (-20°C to 60°C), 0 to 80% R.H. with battery removed from meter.	
Accuracy	Stated accuracy at 23°C (+5°C), <75% relative humidity.	
Dimensions (HxWxD)	7.5 x 2.64 x 1.4" (189 x 67 x 35mm).	
Weight	7oz. (200g) including battery (approx).	
CO		
Range	0 to 1000PPM (2000PPM with 5 minute max exposure time.)	
Sensor Calibration	Factory calibrated on 205ppm.	
Sensor Type	Electrochemical (specific to CO) Initial Accuracy: +5% of reading +5PPM Response time: <70sec to 90% of reading Operating Temperature: 32 to 105 °F Operating relative humidity: 15 to 90%RH, non-condensing	
Long term drift	<5% / year (depending on use)	
Battery life	200 hours typical (No measurable current draw when in "off" position).	
One Year Warranty		

Temperature Probes

Enhance the utility of the Humidity/Temperature and Temperature meters with a selection of K-type temperature probes. Select the probe that best fits the application.

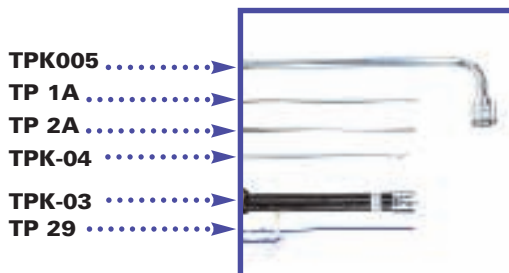

TPK-05

Surface Probe, Rt-Angle -58°~752°F (-50°~400°C)

TP 1A

Immersion Probe, Standard -58°~1,650°F (-50°~900°C)

TP 2A

Air & Gas Probe -40°~570°F (-40°~ 300°C)

TPK-04

Piercing Probe -58°~1,122°F (-50°~600°C)

TPK-03

Surface Probe, Standard -58°~752°F (-50°~400°C)

TP 29

Bead Probe, Standard -58°~392°F (-50°~200°C)

TP 3 (not shown)

Bead Probe, Hi-Temp -40°~900°F (-40°~480°C)

Sound Level Meters Models 732A & 735

Whether you are testing for OSHA compliance, quieting equipment, or monitoring the roar of a stadium crowd, B+K Precision's Sound Level Meters can get the job done. The model 732A and 735 Sound Level Meters provides 30~130 dB capability in three convenient measurement ranges Low, Med and Hi with an accuracy of ± 1.5 dB. The meter meets the IEC 651 Type II and includes frequency weighting A & C and fast and slow time weighting. Two auxiliary ports provide either AC output, 1Vrms full scale, or DC output, 10mV /dB. With models 732A or 735, B&K Precision can meet all your sound testing needs.



Model 732A

Common features

- RS-232 Interface
- Bargraph
- MAX/MIN function
- Auto Ranging (30 ~ 130dB)
- Resolution 0.1dB
- Level Range Display
- AC/DC Signal Output

Common features

- Auto Power Off
- Backlit LCD
- Model 735 only
- Windows Software Included
- Clock Display
- 32,000 Records Data Logger

Specifications model

	732A, 735
Level Range	Low: 30~80 dB Med: 50~100 dB Hi: 80~130 dB
Frequency Weighting	A, C
Time Weighting	Fast, Slow
Accuracy	± 1.5 dB (ref 94 dB @ 1kHz)
Dynamic Range	50 dB
Frequency Range	31.5Hz to 8kHz
Auxiliary Outputs	AC: 1Vrms (full scale) 50 Ω impedance DC: 10mV / dB 100 Ω impedance (approx.)
Operating Temp. & Humidity	32° ~ 104°F (0° ~ 40°C) & 10~80% RH
Storage Temp	-4° ~ 140°F (-20° ~ 60°C) <70% RH
Power Supply	9V NEDA 1604 (Optional adapter BE-9)
Battery Life	Approximately 50 hrs (Alkaline)
Dimensions (LxWxH)	10.83 x 2.52 x 1.18" (275 x 64 x 30mm)
Weight	1.56 lbs. (710g)

Accessories One Year Warranty

SUPPLIED: Instruction Manual, Battery, Carrying Case, Calibration Screwdriver, Windscreen
OPTIONAL: BE9 AC Adapter

Sound Level Calibrator Model CAL73

The CAL73 sound level calibrator is used to calibrate sound level meters and other sound measurement equipment. You can calibrate 1 inch diameter microphones directly and 1/2 inch microphones using 1/2 inch adapter supplied with the calibrator.

- Conforms to IEC 60942 (2003) Class 2, ANSI S1.40-1984
- 94dB and 114dB Sound calibrator at 1KHz
- Accurate and simple to use
- Fits 1 inch and 1/2 inch microphones



Air Velocity & Sound Meters

Precision Anemometer Model 731A

The B+K Precision model 731A is a mechanical vane on retractable cord anemometer designed to measure airflow and air temperature.



- Measurement units: Knots, MPH, KPH, m/sec, ft/min
- Auto power off
- Data Hold
- MIN/MAX/Average
- Back light display
- CE approved

Specifications model

	731A		
Wind Velocity			
Units	Resolution	Threshold	Range
m/s	0.01	0.4	0.0 - 30.0
ft/min	1	80	0.0 - 5900
knots	0.1	0.8	0.0 - 28.0
mph	0.1	0.9	0.0 - 67.0
Accuracy: +3% FS			

Specifications model

	731A
Temperature	
Sensor	Thermistor temperature sensor
Range	-20°C to 140°C
	-4°F to 140°F
Resolution	0.1°C / 0.1°F
Accuracy:	
	+0.5°C 0°C to 45°C
	+1°C -20°C to 0°C, 45°C to 60°C
	+1°F 32°F to 113°F
	+2°F -4°F to 32°F, 113°F to 140°F
General	
Display	4 digit LCD
Accuracy	Stated accuracy at 73°F +4°F (23°C +5°C), <75% R.H.
Dimensions	(HxWxD) 9 x 2.6 x 1.4" (228 x 65.5 x 35mm)
Weight	11.64oz. (330g)

One Year Warranty

Environmental

Introducing:

ANAHEIM SCIENTIFIC
Division of **BK PRECISION**



Professional Environmental Test Equipment

Anaheim Scientific is the environmental test division of B&K Precision Corporation. We are committed to manufacturing high quality, professional environmental test equipment. Anaheim Scientific products come with an industry leading two year warranty and an extensive technical product support.

Whether you are measuring temperature, humidity, DEW point, light levels, RGB color levels or air flow, Anaheim Scientific has the meter for you.

For current product information please visit www.anaheimscientific.com

Environmental

... Testing the world around you



Basic Infrared Thermometer N625



The model N625 is an excellent entry level non-contact infrared thermometer for many applications. It can accurately make temperature measurements from short distances and up to as much as many feet.

Features:

- Non-contact temperature measurements
- On/Off switchable laser sighting
- High 12:1 DS ratio
- Selectable Fahrenheit or Celsius display
- Temperature range: -25 to 999 °F (-32 to 535 °C)

Applications:

- HVAC
- Electrical troubleshooting
- Automotive repair & maintenance
- Science experiments
- Measure terminals on circuits
- Air conditioning testing and maintenance
- Perform HVAC energy audits
- Manufacturing processes of semiconductor technologies
- Food safety and processing

Advanced Infrared Thermometer N630



The model N630 is an excellent non-contact infrared thermometer for many applications. It can accurately make temperature measurements from short distances and up to as much as many feet. It is easy to use and the fact that it has adjustable emissivity settings means it can give very accurate measurements from most any heat source.

Features:

- Non-contact temperature measurements
- Adjustable emissivity from 0.1 to 1.00
- On/Off switchable laser sighting
- High 12:1 DS ratio
- Selectable Fahrenheit or Celsius display
- Temperature range: -25 to 999 °F (-32 to 535 °C)

Applications:

- HVAC
- Electrical troubleshooting
- Automotive repair & maintenance
- Science experiments
- Measure terminals on circuits
- Air conditioning testing and maintenance
- Perform HVAC energy audits
- Manufacturing processes of semiconductor technologies
- Food safety and processing

Broad Range Infrared Thermometer N650



The model N650 is a non-contact infrared thermometer designed for the measuring of high temperatures.

Features:

- Non-contact temperature measurements
- Adjustable emissivity from 0.1 to 1.00
- On/Off switchable laser sighting
- High 12:1 DS ratio
- Selectable Fahrenheit or Celsius display
- Temperature range: -58 to 1830 °F (-50 to 999 °C)

Applications:

- Electrical troubleshooting
- Automotive repair & maintenance
- Science experiments
- Measure terminals on circuits
- Air conditioning testing and maintenance
- Perform HVAC energy audits
- Test terminals or IC temperatures on PCBs
- Manufacturing processes of semiconductor technologies
- Food safety and processing

Environmental

Four Channel Thermometer with Data Logger H240



The model H240 is an easy to use four channel thermocouple thermometer with a built in data logger feature.

Features:

- Measures temperature from up to four probes
- 0.1 Resolution
- Fast response time
- High level of accuracy
- Large LCD display
- Two year warranty
- K-Type temperature range: -199 to 2498 °F (-199 to 1370 °C). Note that the temperature probes used might have a narrower temperature range.

Applications:

- HVAC
- Science experiments
- Plant maintenance
- Manufacturing
- Agriculture
- Quality control

Single Channel Thermocouple thermometer H200



The model H200 is an easy to use single channel thermocouple thermometer with a wide testable temperature range suitable for use with many thermocouple probe types.

Features:

- Type J/K/R/E/T thermocouple thermometer
- Microcomputer controller circuit provides excellent performance
- Wide temperature measuring range
- Selectable Fahrenheit or Celsius display
- Accepts type J/K/R/E/T thermocouples
- 0.1 degree resolution for type K/J/T/E
- Data hold
- Memory function to record the maximum & minimum reading
- REL button for relative measurement
- Auto power off saves battery life
- DC 1.5V battery (UM-4, AAA) x 6
- Longer battery life compared to 9V
- Fast response time
- High level of accuracy
- Two year warranty
- K-Type temperature range: -148 to 2372 °F (-100 to 1300 °C). Note that the temperature probes used might have a narrower temperature range.

Applications:

- HVAC
- Science experiments
- Plant maintenance
- Manufacturing
- Agriculture
- Quality control

Humidity/ Temperature Meter with DEW Point and Data Logger H300



The model H300 is an ideal meter for taking Temperature, Humidity and DEW Point measurements. All three measurements are important for maintaining optimal levels during environmentally sensitive manufacturing of items such as; cosmetics, pharmaceuticals, paints, chemicals, foods etc... They are also important indicators of good indoor air quality in hospitals, hotels or office buildings. Lightweight and easy to use, the model H300 is the perfect tool for HVAC and IAQ monitoring.

Features:

- Humidity, Temperature and Dew Point measurements
- 0.01 Resolution for Temperature and RH measurements
- Fast response time
- High level of accuracy
- Large LCD display
- Two year warranty
- RH Range: 5% to 95%
- Temperature range: 32 to 122 °F (0 to 50 °C)

Applications:

- HVAC
- Manufacturing processes
- Quality control in production and manufacturing
- Science experiments
- Plant maintenance
- Agriculture



For current product information please visit:
www.anaheimscientific.com

Environmental

Wide Range Light Meter H100



The model H100 is an ideal meter for measuring light levels in both lux and foot-candle units of measure. The meter's wide measuring range allows it to be used in many applications such as interior design, photography, energy audits and installation of electrical fixtures. It is perfect for general applications, including measuring lighting levels in the home, office, restaurant, school.

Features:

- Large LCD display with bar graph
- Wide measurement ranges:
40.00/400.0/4,000/40,000/400,000lux
- Display resolution: 0.04lux to 100lux,
0.01fc to 10fc (foot-candle = fc)
- 4 light type select (Tungsten,
Fluorescent, Sodium or Mercury)
- Sensor meet C.I.E. spectrum, 2 filters
- Data hold, Record (max., min.)
- lux or foot-candle unit selection
- Longer battery life compared to 9V
- Displays values in both lux or
foot-candle
- Two year warranty

Applications:

- Science experiments
- Photography
- Manufacturing
- Agriculture
- Artistry

Anemometer with Temperature H400



The model H400 is an easy to use anemometer with temperature meter. It is the perfect meter for measuring both wind speed and temperature.

Features:

- Measure both temperature and air flow
- Selectable °C & °F measurements
- Displays air flow in m/s, km/h, mph,
knots & ft/min
- Two year warranty
- Air velocity range: 0.9 to 55.9mph
- Temperature range: 32 to 122 °F
(0 to 50 °C)

Applications:

- HVAC
- Energy audits
- Environmental experiments
- Building maintenance
- Agriculture
- Science experiments

RGB Color Analyzer H500



The model H500 is an RGB Color Analyzer that can measure the amount of Red, Blue and Green as well as the Hue, Saturation and Luminance of items such as Paints, Plastics, Fabrics, or just about anything you might need to know the color of.

Features:

- Measure both RGB and HSL levels
- Easy to use relative (REL) feature allows
the comparison of two color samples
- Easy to use
- Two year warranty

Applications:

- Check color levels of Plastics, Textiles,
Paper, Paints and Leathers
- Quality control in production and
manufacturing
- Comparisons of color samples against
color standards
- Check reference color values of CRTs,
LCD monitors and light lamps



Model H300
Measuring dew point
in the field

DMMs with Accessory Kits

True RMS DMM with Test Lead Set

Model 2880BKIT

This kit contains the B&K Precision model 2880B Digital Multimeter and a selected assortment of test lead accessories.

Included Test Lead Accessories

- Highly flexible silicone test leads with sheathed (shrouded) 4mm banana plugs; Right-angle for the meter, straight for the accessories, 1.5m long. Rated IEC 61010-031 1000V CAT III / 600V CAT IV to 12A
- Smooth 2mm tip probe bodies, ideal for everyday testing. Ruggedly constructed, they are rated to IEC 61010-031 1000V CAT III / 600V CAT IV to 36A.
- Flexible pincer clips for long reaches. Pincer tips can grip contact points –up to 0.16" diameter in either electronic or electrical applications. Rated IEC 61010-031 1000V CAT III / 600V CAT IV to 6A
- General purpose probe leads with flexible PVC jacketed wire, 2mm smooth probe tips and right angle sheathed banana plugs. Rated to IEC 61010-031 1000V CAT III / 600V CAT IV to 10A.
- 14" rugged clear plastic carrying case with foam inserts. Holds both meter and accessories



True RMS Deluxe DMM with Test Lead Set

Model 2890AKIT

This kit contains the B&K Precision model 2890A Digital Multimeter and a selected assortment of test lead accessories.

Included Test Lead Accessories

- Highly flexible silicone test leads with sheathed (shrouded) 4mm banana plugs; Right-angle for the meter, straight for the accessories, 1.5m long. Rated IEC 61010-031 1000V CAT III / 600V CAT IV to 12A
- Smooth 2mm tip probe bodies, ideal for everyday testing. Ruggedly constructed, they are rated to IEC 61010-031 1000V CAT III / 600V CAT IV to 36A.
- Flexible pincer clips for long reaches. Pincer tips can grip contact points –up to 0.16" diameter in either electronic or electrical applications. Rated IEC 61010-031 1000V CAT III / 600V CAT IV to 6A
- General purpose probe leads with flexible PVC jacketed wire, 2mm smooth probe tips and right angle sheathed banana plugs. Rated to IEC 61010-031 1000V CAT III / 600V CAT IV to 10A.
- Spring-loaded tip miniature probe bodies. Small in size for compact probing, they are ideal for miniature probing of electronic circuits. Rated IEC 61010-031 600V CAT III to 1A.
- K-Type thermocouple with banana plug adapter. Utilize the temperature measuring capability of the 2890A DMM with this thermocouple and adapter combination. The bead-tip thermocouple measures between –50° to +392° F and is 1m long.
- 14" rugged clear plastic carrying case with foam inserts. Holds both meter and accessories.



388B DMM with Test Lead set Model 388BKIT

This kit is ideal for general purpose electronic and electrical trouble shooting or repair. Kit contains flexible pincer and alligator clips for larger components and miniature hook clips for smaller ones.

Included Test Lead Accessories:

- 1.5 Meter Long Silicone 4mm Sheathed Straight to Right-Angle Plug Lead Set
- Flexible Pincer Set – Red & Black
- Alligator Clip Set – Red & Black
- Probe Body Set With 2mm (.080") Diameter Tips
- Hook Test Clip to 4mm Banana Jack
- Tri-Fold Nylon Pouch



391A True RMS DMM with Test Lead set Model 391AKIT

The 391AKIT is the perfect kit for anyone testing or measuring electronic circuits. Kit includes spring-load tip miniature probes for testing those micro-sized circuits.

Included Test Lead Accessories

- 1.5m Long Silicone 4mm Sheathed Straight to Right-Angle Plug Lead Set
- Flexible Pincer Set – Red & Black
- Probe Body Set With 2mm (.080") Diameter Tips.
- Miniature Spring-Tip Probe – Red & Black
- Tri-Fold Nylon Pouch



2704B DMM with Test Lead set Model 2704BKIT

This kit includes a perfect introduction meter and accessories. Basic starter leads for everyday use.

Included Test Lead Accessories

- 1.5m Long Silicone 4mm Sheathed Straight to Right-Angle Plug Lead Set
- Alligator Clip Set – Red Black



Multimeters Accessories

High Performance Bench Top DMM Accessory Kit TL500



Features:

- Silicone jacket sheathed test leads
- Spring-loaded miniature test probes
- Miniature hook and pincer clips
- IEC61010-1 safety standards
- Storage case

Applications:

- Production Test Stations
- R&D Labs
- Service & Repair Facilities
- Educational Test Benches

Deluxe Accessory Kit for High Performance Bench Top Digital Multimeters (DMMs):

As a bench technician once commented, "it's all about the size." You need the right size accessory to make your test. With Model TL 500 Deluxe Bench DMM Accessory Kit, you have that selection. The kit offers MiniProbe™ test probe, with spring-loaded tips, for fine probing; MiniPRO™ Test Clips for small and MiniFlex™ Test Clips for micro connections; and for those larger test points, both spade lug and banana plug adapters. All these high quality components connect to a pair of silicone jacketed leads with sheathed banana plugs. A second pair of test leads, which also meet IEC61010-1 safety standards, are included for 4-wire measurements or calibration hookups. An insulated BNC male to sheathed banana jack adapter is included for connection to RF test equipment as well as an insulated SMD Tweezer set for chip-size component testing. This kit contains everything a bench technician needs. The kit is provided in a convenient foam lined storage box for easy selection and use.

Kit Contents:

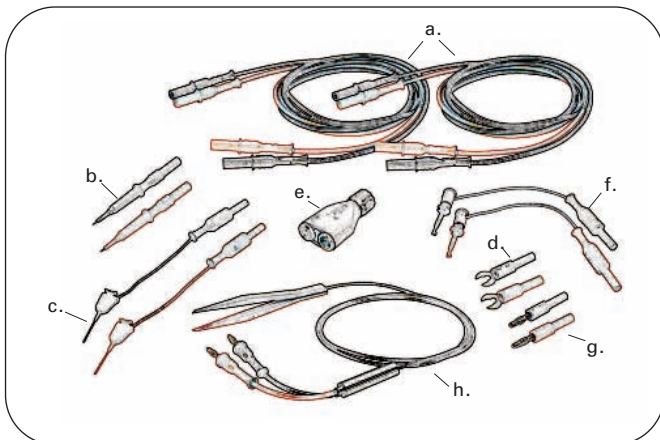

Item	Description	Qty.	(IEC Rating)	Voltage Current Max.
a.	Silicone Leads, 150cm (60"), Black	2	1000 V CAT III	12 A
a.	Silicone Leads, 150cm (60"), Red	2	1000 V CAT III	12 A
b.	MiniProbe, Black	1	600 V CAT III	1 A
b.	MiniProbe, Red	1	600 V CAT III	1 A
c.	MiniFlex Clip, 10cm (4"), Black	1	33Vdc/70Vac	1 A
c.	MiniFlex Clip, 10cm (4"), Red	1	33Vdc/70Vac	1 A
d.	6/4mm Spade Lug Adapter, Black	1	33Vdc/70Vac	36 A
d.	6/4mm Spade Lug Adapter, Red	1	33Vdc/70Vac	36 A
e.	Insulated BNC Adapter	1	500 V CAT I	3 A
f.	MiniPRO Clip, 10cm (4"), Black	1	33Vdc/70Vac	6 A
f.	MiniPRO Clip, 10cm (4"), Red	1	33Vdc/70Vac	6 A
g.	Banana Plug Adapter, Black	1	33Vdc/70Vac	36 A
g.	Banana Plug Adapter, Red	1	33Vdc/70Vac	36 A
h.	SMD Tweezers w/Plugs	1	400 Vrms	2 A

Specifications subject to change without notice

Multimeters Accessories



40kV High Voltage DMM Probe

Model PR 28A

If the voltages you need to measure are above the specifications of general purpose probes, B+K Precision has a higher voltage probe for you.

Specifications

	model PR 28A		
Attenuation	x1000	Impedance	1000MΩ
Voltage (AC)	20kV	Accuracy (AC & DC)	±3%
Voltage (DC)	40kV	Cable Length	48" (1.2m)
Bandwidth	60Hz		



Maxi-Pro DMM Kit

Model TL-50

Complete accessory kit for all your testing needs. Includes soft, flexible silicone lead wire easy movement and tri-fold Velcro pouch for convenient storage.

- All components compliant to IEC61010-2-031
- Silicone Lead Wire length 60" (1.5m)
- Tri-fold Velcro pouch

Features

	model TL-50		
4mm Straight to Right-Angle Silicone Leads, 1.5m	1000V	CATIII	12A
Probe Bodies w/Ø2mm Tip	1000V	CATIII	36A
Pincer Style Clips	1000V	CATIII	6A
Alligator Clips	300V	CATI	3A
Spade Lug Adapters	42V (1000V)		36A
Banana Plug Adapters	42V (1000V)		36A
Fully Insulated Alligator Clips	1000V	CATIII	20A

Replacement Test Leads

Deluxe Test Lead Sets

Model TL 2A

- IEC61010 1000V CATIII Rating
- Silicone Lead Wire length 60" (1.5m)
- Black Alligator Clip included
- Threaded tips fits TL 3 Accessory kit items



Probe Accessory Kit

Model TL 3

- Threaded accessories to fit TL 2A probes - Black and Red pairs (except for alligator clip)
- Alligator clip, Red only
- Spring hook clips
- 4" Sharp extension tips to reach tight test points
- No. 10 Spade lugs

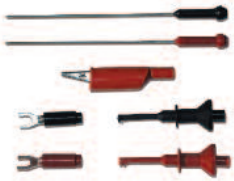

Model TL 1

Model TL 4

Economical replacement test leads. TL 1 has safety shrouded banana plugs. TL 4 has un-shrouded banana plugs.

- 1500V 3A ratings
- PVC lead wire, 40" (1.0m)
- Black and Red Alligator clips



Surface Mount Tweezers

TL 8

- Two conductor leads
- 400V rms, 1A



General Purpose DMM Kit

Model TL 130A

If you need only one basic accessory kit for your meter, this is the one. Attach probes or clips to the sheath plug to complete your test. Soft, flexible silicone leads make movement easy. Kit is voltage and current rated for either electronic or electrical applications.

- All components compliant to IEC61010-2-031
- Silicone Lead Wire length 60" (1.5m)
- Tri-fold Velcro pouch

Features

	model TL 130A		
4mm Straight to Right-Angle Silicone Leads, 1.5m	1000V	CATIII	12A
Probe Bodies w/Ø2mm Tip	1000V	CATIII	36A
Alligator Style Clips	1000V	CATIII	20A
Alligator Clips	300V	CATI	3A

DC/AC Current Clamp

Model CP 3

- Converts any DMM to a current clamp
- Measures current without disconnecting circuit under test
- Measures to 400A DC or AC
- Outputs 1 mV per Amp, operates on 2V range of any DMM



Specifications

	model CP 3		
	(Accuracy specified at 18° to 28°C)		
Current Range	2A to 400A, DC or AC		
Frequency Response (AC)	50 Hz - 400 Hz		
Accuracy	±(2% reading + 2A)		
Input Resistance	10kΩ min.		
Maximum Conductor Size	1.1"(30mm)		
Power Requirement	9V battery, NEDA 1604		
Battery Life	100 hr typical		
Operating Temperature	0° to 40°C, <70% RH		
Storage Temperature	-20° to + 70°C, <80% RH		

Oscilloscope Accessories



Active Differential Probe

Model PR-60

Allows safe and accurate floating measurements with your standard analog or digital oscilloscope. Switchable between x10 and x100 attenuation. Unit includes black and red probes and protective rubber jacket.

Features

	model PR-60
Bandwidth	25MHz (-3dB)
Attenuation Ratio	x10/x100
Accuracy	±2%
Rise Time	14 ns
Input Impedance	4MΩ/10pF each side to ground
Input Voltage	
Max. Differential	±700V (DC+Peak AC)
Max. Common Mode	±700V (DC+Peak AC)
Output Voltage	
Max. Amplitude	±7V (into 2kΩ load)
Offset (Typical)	≤ ±5mV, -10° to 40° C
Noise (Typical)	1.5 to 2mV
Source Impedance	1Ω @ 1kHz 8Ω @ 1MHz
CMRR	
50Hz	86 dB
20kHz	66 dB
200kHz	56 dB
Probes	Sprung Hooks (B/R)
Length of Input Lines	18" (45cm)
Operating Temperature	14° to 104°F (-10° to 40°C)
Power Requirements	4 x AA Cells
Certification	IEC61010-1 CATIII

General Purpose Probes

B+K Precision offers a complete line of oscilloscope probes to enhance the versatility of your unit. Both fixed attenuation and switchable from 100 to 250 MHz are available. Each probe includes a full accessory kit with a Sprung Hook, Replacement Tip and BNC Adapter.

■ All models compliant to
IEC61010-031



PR 33A



PR 100A



PR 37AG



PR 2000

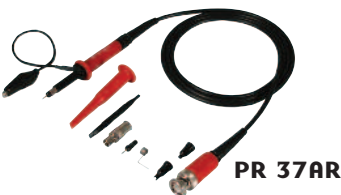

PR 37AR



PR 4000



PR 150



PR-55

Specifications

	PR 33A	PR 37AG	PR 37AR	PR 150	PR 100A	PR 2000	PR 4000	models PR-55
Bandwidth (MHz)	15/90	6/150	6/150	25/150	250	150	100	50
Attenuation	x1/x10	x1/x10/REF	x1/x10/REF	x1/x10	x100	x100	x100	x1000
Input Impedance								
R(MΩ)	1/10	1/10	1/10	1/10	100	50	50	100
C(pF)	46/16	100/15	100/15	45/12	6.5	5	5	1
Voltage (VDC+ACmax)	600	600	600	300	1,200	2,000	4,000	10,000
Compensation (pF)	10..35	10..35	10..35	10..30	10..35	10..30	10..30	10..30
Cable Length	48" (1.2m)	48" (1.2m)	48" (1.2m)	48" (1.2m)	48" (1.2m)	48" (1.2m)	48" (1.2m)	80" (2.0m)
Body Color	Black	Gray	Red	LtGray	Black	Red	Red	Yellow

Oscilloscope Accessories

Oscilloscope Probe Set, 3 Pieces - x1/x100/Switchable Model PR-50

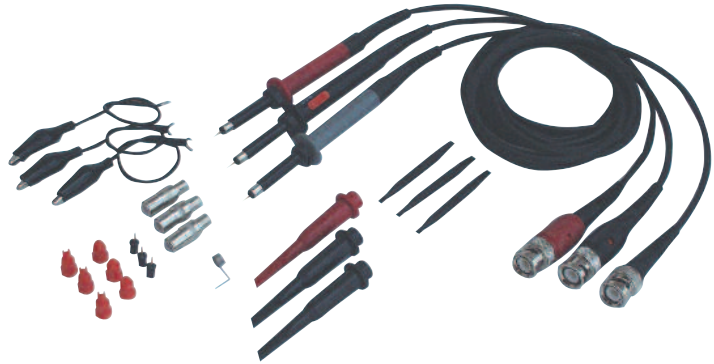

Features	model		
		PR-50	
Attenuation	x1	x1/x10/REF	x100
Input Impedance			
R(MΩ)	*	1/10	100
C(pF)	46	100/15	6.5
Bandwidth (MHz)	15	6/150	250
Voltage (VDC+ACmax)	600	600	600
Compensation (pF)	---	10..35	10..35
Cable Length	48" (1.2m)	48" (1.2m)	48" (1.2m)
Body Color	Gray	Grey	Black

* Input impedance of oscilloscope.

If you need a complete range of probe attenuation, then this is the kit for you. It contains three probes - x1, x100, and x1/x10 switchable. They are of the same high quality as B+K Precision standard probes but in one convenient kit. Each probe includes a full accessory offering with Sprung Hook, Replacement Tip, Ground Lead and BNC Adapter. All probe are compliant to IEC61010-031.

General Purpose Oscilloscope Adapter Kit CC540



Features:

- BNC & N Type 50Ω Connectors
- Gold plated center contacts
- Storage case

Applications:

- Production Test Stations
- Service & Repair Facilities
- Educational Test Benches
- Calibration Work

Model CC540 General Purpose Oscilloscope Adapter Kit provides a range of BNC and N type coaxial interconnection for general purpose oscilloscope test interconnections. All components feature standard BNC or N type connectors with 50Ω impedance to ensure accurate measurements. The kit is provided in a convenient foam lined storage case for easy selection and use.

Economical Accessory Kit for General Purpose Oscilloscope Instruments:

Kit Contents:

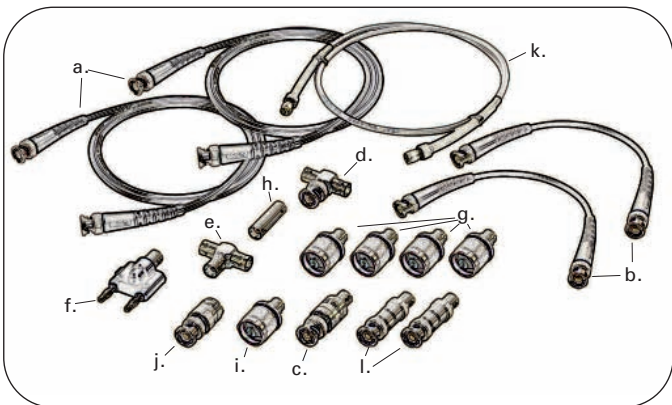

Item.	Description	Qty.	Frequency Range	VSWR Max.
a.	BNC male Cable, 100cm (40")	2	DC - 1 GHz	1.20:1 @ 1 GHz
b.	BNC male Cable, 25cm (10")	2	DC - 1 GHz	1.20:1 @ 1 GHz
c.	BNC Feed-Thru Terminator, 2W	1	DC - 1 GHz	1.35:1 @ 1 GHz
d.	BNC Tee, female-male-female	1	DC - 4 GHz	N/A
e.	BNC Tee, female-female-female	1	DC - 4 GHz	N/A
f.	BNC female to Double Banana Plugs	1	N/A	N/A
g.	BNC female to N type male	4	DC - 4 GHz	1.30:1 @ 4 GHz
h.	BNC female-female	1	DC - 4 GHz	1.30:1 @ 4 GHz
i.	N Type male to SMA female	1	DC - 8 GHz	1.30:1 @ 8 GHz
j.	BNC male to N type female	1	DC - 4 GHz	1.30:1 @ 4 GHz
k.	SMA male Cable, 100cm (40")	1	DC - 6 GHz	1.20:1 @ 6 GHz
l.	BNC Attenuator, 20dB (10x) 2W	2	DC - 4 GHz	1.25:1 @ 4 GHz

General Purpose Accessories

Special BNC Cable Assemblies

Models CC-21 & CC 130

Standard BNC to Alligator clips or Sheathed Stacking Plugs. Model CC-21, Black, molded strain release boots provides for long-life. RG58C/U cable with 50Ω impedance. Model CC-130 with fully insulated BNC male to Sheathed Stacking 4mm plugs. Meets IEC61010 safety standards Includes highly flexible RG58 type cable in 2.0 meter length. Color: Black.



Demodulator Probe Model PR 32A

All purpose demodulator probe, usable with most oscilloscopes. Features light weight design and 48" (1.2m) coaxial cable.



Features		model
		PR 32A
Bandwidth	100kHz-650MHz	
Accuracy	± 3dB	
Voltage	200V	
HF Voltage	50Veff	
Actuating Voltage	250mV	
Input Capacitance	5pF	
Cable Length	48" (1.2m)	
Body Color	Black	

Features

	model	
	CC-21	CC 130
Impedance	50Ω	50Ω
Cable	RG58 C/U	RG58 type
Connectors	BNC m to Alligator Clips	Insulated BNC male to 4mmPlugs
Voltage	500Vrms	150V CAT II
VSWR	≤ 1.2	≤ 1.2
Cable Length	40" (1.0m)	80" (2.0m)

General Purpose Function Generator Kit CC510



Features:

- BNC & N Type 50Ω Connectors
- Gold plated center contacts
- Storage case

Applications:

- Production Test Stations
- Service & Repair Facilities
- Educational Test Benches

Kit Contents:

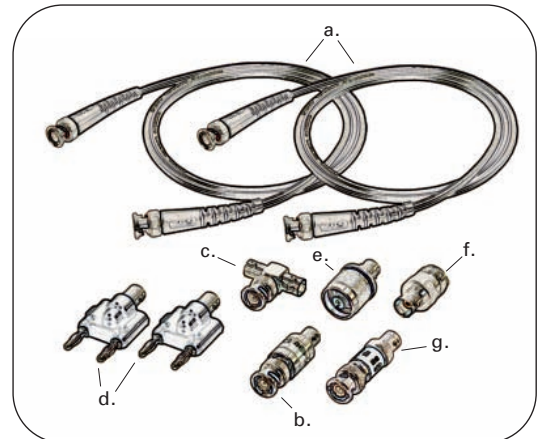

General Purpose Accessory Kit for Function Generators and Other Instruments:

Model CC 510 General Purpose Function Generator Kit provides a range of BNC and N type coaxial interconnection for basic function / arbitrary waveform generators use. All components feature standard BNC or N type interfaces with 50Ω impedance and gold plated center contacts to ensure accurate repeatable measurements. The kit is provided in a convenient foam lined storage case for easy selection and use.

Itm.	Description	Qty.	Frequency Range	VSWR Max.
a.	BNC Cable Assembly, 100cm (40")	2	DC - 1 GHz	1.20:1 @ 1 GHz
b.	BNC Feed-Thru Terminator, 2W	1	DC - 1 GHz	1.20:1 @ 1 GHz
c.	BNC Tee, female-male-female	1	DC - 4 GHz	N/A
d.	BNC female to Double Banana Plugs	2	N/A	N/A
e.	BNC female to N type male	1	DC - 4 GHz	1.30:1 @ 4 GHz
f.	BNC female to N type female	1	DC - 4 GHz	1.30:1 @ 4 GHz
g.	BNC Attenuator, 20dB (10x) 2W	1	DC - 4 GHz	1.25:1 @ 4 GHz

Function Generator Accessories

Deluxe Function Generator & Counter Kit CC520



Deluxe Accessory Kit for Function, Signal & Arbitrary-waveform Generators and Frequency Counters:

Model CC 520 Deluxe Function Generator / Counter Kit provides a complete range of coaxial adapters and cables for general-purpose function, signal & arbitrary-waveform generators as well as frequency counters. All kit components feature precision machined bodies, 50Ω impedance and low VSWR to ensure accurate and repeatable measurements. The kit is provided in a convenient foamlined case for easy component selection and storage.

Features:

- BNC & N Type 50Ω Connectors
- Deluxe Adapters
- Gold plated center contacts
- Storage case

Applications:

- Production Test Stations
- R&D Labs
- Service & Repair Facilities
- Calibration Services
- RF Field Testing

Kit Contents:

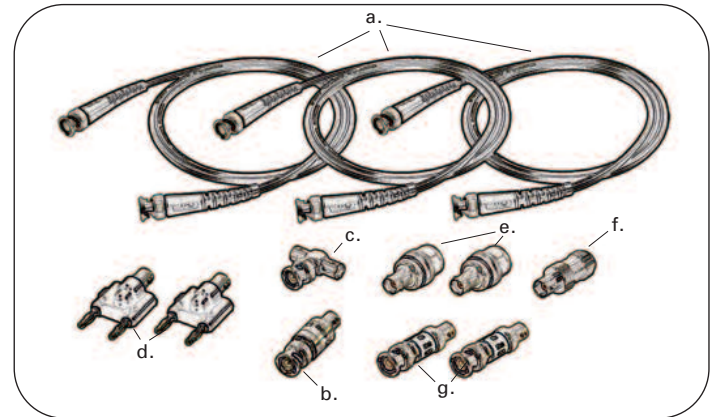

Item	Description	Qty.	Frequency Range	VSWR Max.
a.	BNC Cable Assembly, 100cm (40")	3	DC - 1 GHz	1.20:1 @ 1 GHz
b.	BNC Feed-Thru Terminator,	1	DC - 1 GHz	1.20:1 @ 1 GHz
c.	BNC Tee, female-male-female	1	DC - 10 GHz	N/A
d.	BNC female to Double Banana Plugs	2	N/A	N/A
e.	BNC female to N type male	2	DC - 10 GHz	1.22:1 @ 4 GHz
f.	BNC female to N type female	1	DC - 10 GHz	1.07:1 @ 2 GHz
g.	BNC Attenuator, 20dB (10x) 2W	2	DC - 4 GHz	1.25:1 @ 4 GHz

Function Generator Accessory Kit Model TLFG

Model TLFG, Function Generator Kit provides the convenience and functionality to get a user up and working. The kit eliminates that time consuming initial task of collecting cables and adapters just to get started.

The TLFG Function Generator kit provides a complete starting selection of accessories including:

- 2 1.2m (48") BNC (m) Cable Assemblies w/RG-58C/U Cable and molded Bend Relief Boots.
- 1 BNC (f) Breakout w/ Miniature Alligator Clips, 9" Silicone Wire
- 1 BNC (f) Breakout w/ Ø.031 Sockets, 9" Silicone Wire
- 2 MiniFlex IC Clips, 1 Black and 1 Red
- 2 MicroClip IC Clips, 1 Black and 1 Red
- 1 BNC (f-m-f) In-series Adapter
- 1 BNC (f) to N (M) Between Series Adapter

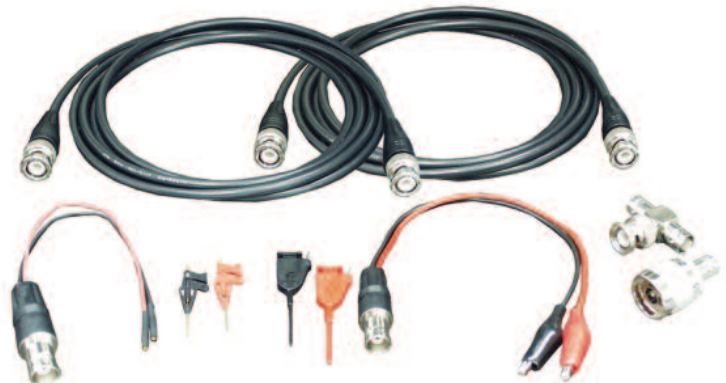

Features:

- High capacity retractable sheath leads
- Connection Adapters
- Extra-large insulated alligator clips
- Black, red & green components
- Storage case

Applications:

- R&D laboratories
- Production test stations
- Service & repair facilities
- Educational test benches

Kit Contents:

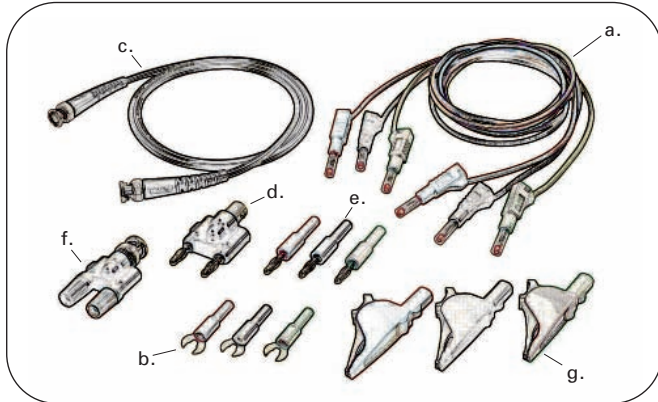

Power Supply Accessories

General Purpose Power Supply Accessory Kit CC545

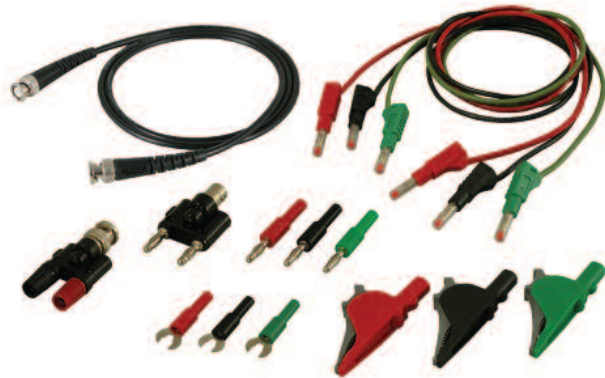

Complete Accessory Kit for General Purpose Bench Top Power Supplies:

Model CC 545 General Purpose Power Supply Accessory Kit provides most everything one needs to put their bench power supply to work. The kit includes 3 high capacity test leads with retractile sleeve plugs. Rated at 600 V CAT II and 36 Amps, the leads provide safe connection to either standard or sheathed jacks while its silicone jacket wire stays flexible under all conditions.

For day to day connections, included are 4/6mm spade lug adapters along with 4mm banana plug adapters. Unique to the kit are 3 extra-large alligator clips which offer a wide range of connection capabilities. Fully insulated 1,000V CAT III or 600V CAT IV, the clips are capable of attaching to leads as small as 0.01" or lugs to a diameter of 1.25" all while carrying currents up to 36A. All components are supplied in black, red and green for easy identification.

Also included is a BNC female to double banana plug adapter, BNC male to double binding post adapter and a BNC male cable assembly for powering those RF testing applications.

Item.	Description	Qty.	(IEC Rating)	Voltage Current Max.
a.	Retractable Lead, 100cm (40"), Black	1	600 V CAT II	36 A
a.	Retractable Lead, 100cm (40"), Red	1	600 V CAT II	36 A
a.	Retractable Lead, 100cm (40"), Green	1	600 V CAT II	36 A
b.	6/4mm Spade Lug Adapter, Black	1	33Vdc/70Vac	36 A
b.	6/4mm Spade Lug Adapter, Red	1	33Vdc/70Vac	36 A
b.	6/4mm Spade Lug Adapter, Green	1	33Vdc/70Vac	36 A
c.	BNC Cable Assembly, 100cm (40")	1	500 Vrms	3 A
d.	BNC female to Double Banana Plugs	1	500 Vrms	3 A
e.	Banana Plug Adapter, Black	1	33Vdc/70Vac	36 A
e.	Banana Plug Adapter, Red	1	33Vdc/70Vac	36 A
e.	Banana Plug Adapter, Green	1	33Vdc/70Vac	36 A
f.	BNC male to Double Binding Posts	1	500 Vrms	3 A
g.	Insulated Alligator Clip, Black	1	600 V CAT IV	36 A
g.	Insulated Alligator Clip, Red	1	600 V CAT IV	36 A
g.	Insulated Alligator Clip, Green	1	600 V CAT IV	36 A

Power Supply Accessory Kit Model TLPS

Accessory kit that combines safety and functionality. A must have kit for anyone who uses a power supply. Model TLPS is ideal for use with power supplies in Educational, Service and Maintenance, and Manufacturing applications.

The kit incorporates highly flexible silicone jacketed test leads that utilize a retractable-sheathed banana plug to connect to the power supply and a fixed sheath banana plug to protect the user. A majority of the items contained in the new kit meet IEC61010-031 international safety specifications to 1,000 volts.

■ 4mm Straight to Retractable Stacking

- Silicone Leads, 1.2m (48") 1B + 1R, *33Vrms/70VDC 25A
 - Standard Alligator Clips 1B + 1R, 300VCATI 3A
 - #6/4 Spade Lug Adapters 1B + 1R, *33Vrms/70VDC 36A
 - 4mm Banana Plug Adapters 1B + 1R, *33Vrms/70VDC 36A
- * Higher voltage with a trained user



30A Power Supply Cable

TL 30

- #10 Spade Lug to Large Battery Clip
- 30A rating
- Black and Red pair
- 30" (0.75m) length



5A Banana Plug Power Supply Cables

TL 5A

- 4mm Banana plug to alligator clip
- 5A rating
- Black and Red pair
- 40" (1.0m) length



Spectrum Analyzer Accessories

Spectrum Analyzer Coaxial Cable & Adapter Kit CC265

The kit is a replacement for B&K Precision model numbers:
CC 301, CC 302, CC 303, CC 304, CC 305, CC 306 & CC 307



Features:

- High frequency SMA cable assembly
- BNC & N type 50Ω Adapters
- Gold plated center conductors
- Storage case

Applications:

- R&D laboratories
- Production test stations
- Service & repair facilities
- Educational test benches
- Calibration work

This convenient kit provides the most popular and useful coaxial accessories to inter-connect B&K Precision's 2650 series Spectrum Analyzers.

Included is a high-performance 24" (60 cm) SMA male to male cable assembly rated at 50Ω and 18 GHz. It features gold plated SMA male connectors and FEP jacketed coaxial cable. To interconnect with other instruments and devices, the kit also includes four (4) coaxial adapters, all featuring SMA females for use with the cable assembly: BNC male, BNC female, N type male and N type female. The BNC to SMA adapters are rated to 4 GHz while the N type to SMA adapters are rated to 11 GHz. Both types have 50Ω impedance. The Kit is supplied in a carrying case for protection and convenience.

Kit Contents:

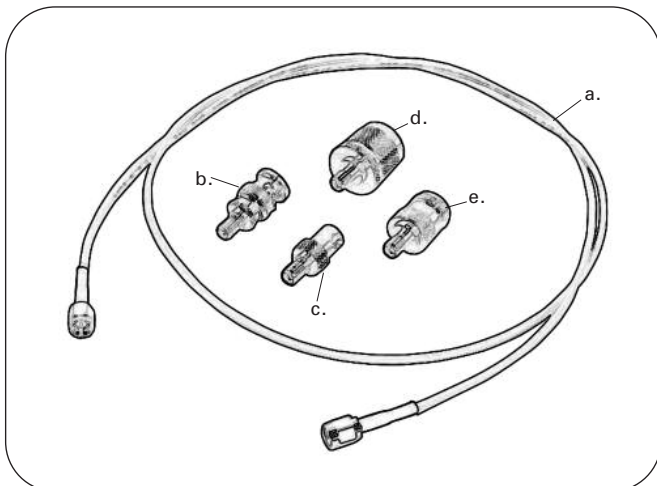

Item	Description	Qty.	Frequency	VSWR Max.
a.	SMA male Cable, 60cm (24")	1	DC – 18 GHz	1.3:1 @ 18 GHz
b.	BNC male to SMA female	1	DC – 4 GHz	1.30:1 @ 4 GHz
c.	BNC female to SMA female	1	DC – 4 GHz	1.30:1 @ 4 GHz
d.	N type male to SMA female	1	DC – 11 GHz	1.30:1 @ 11 GHz
e.	N type female to SMA female	1	DC – 11 GHz	1.30:1 @ 11 GHz

Spectrum Analyzer Accessories

Deluxe Spectrum Analyzer Accessory Kit CC560



Features:

- Convenient interconnection kit
- BNC & N Type 50Ω Connectors
- Instrument Grade Adapters
- Gold plated center contacts
- Storage case

Applications:

- Production Test Stations
- R&D Labs
- Service & Repair Facilities
- Calibration Services
- RF Field Testing

Deluxe Accessory Kit for RF & Microwave Spectrum Analyzers:

Model CC560 Deluxe Spectrum Analyzer Kit provides a complete range of high quality coaxial adapters and cables for Spectrum Analyzer applications. This kit contains just the right mix of high performance accessories for every day testing as well as for instrument performance verification and calibration work.

Selected adapters are Deluxe BNC or N type products. These high quality components easily meet or exceed the instrument manufacturer's recommended accessories specifications. All kit components feature precision machined interfaces, 50Ω impedance and low VSWR to ensure accurate and repeatable measurements.

The kit is provided in a convenient foam-lined case for easy component selection and storage.

Kit Contents:

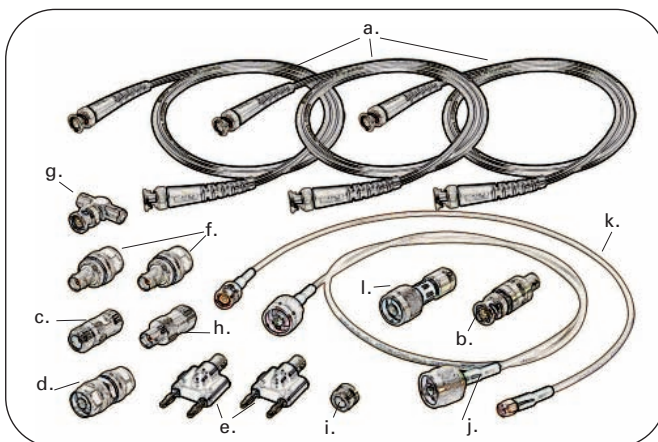

Item	Description	Qty.	Frequency Range	VSWR Max.
a.	BNC Cable Assembly, 120cm (48")	3	DC - 1 GHz	1.20:1 @ 1 GHz
b.	BNC Feed-Thru Terminator, 2W	1	DC - 1 GHz	1.20:1 @ 1 GHz
c.	N type female to female	1	DC - 11 GHz	1.05:1 @ 2 GHz
d.	N type male to male	1	DC - 11 GHz	1.04:1 @ 2 GHz
e.	BNC female to Double Banana Plugs	2	N/A	N/A
f.	BNC female to N type male	2	DC - 10 GHz	1.12:1 @ 1 GHz
g.	BNC Tee female to male to female	1	DC - 10 GHz	N/A
h.	BNC female to N type female	1	DC - 10 GHz	1.04:1 @ 1 GHz
i.	N Type female to SMA female	1	DC - 11 GHz	1.06:1 @ 2 GHz
j.	N Type male Cable, 100cm (40")	1	DC - 18 GHz	1.20:1 @ 10 GHz
k.	BNC to SMA male Cable, 60cm (24")	1	DC - 6 GHz	1.20:1 @ 6 GHz
l.	N Type Attenuator, 10dB (3.2x) 2W	1	DC - 12.4 GHz	1.25:1 @ 12.4 GHz

General Purpose Accessories

General Purpose BNC & N Type Adapter Kit CC500



Features:

- BNC & N type 50Ω Connectors
- Gold plated center contacts
- Storage case

Applications:

- Production Testing Stations
- Service & Repair Facilities
- Educational Test Benches

General Purpose Adapter Accessory Kit for Basic RF Interconnection Needs:

Model CC500 General Purpose BNC & N type Adapter Kit provides a comprehensive range of in-series and between-series BNC and N type coaxial adapters for basic RF testing and troubleshooting needs. The 12 piece kit, packaged in a convenient foam-lined storage case for easy selection and use, is ideal for all popular instruments. The kit contains the most commonly used BNC and N type adapters for everyday testing. All components feature 50Ω impedance, gold plated center contacts, and low VSWR to ensure accurate repeatable measurements.

Kit Contents:

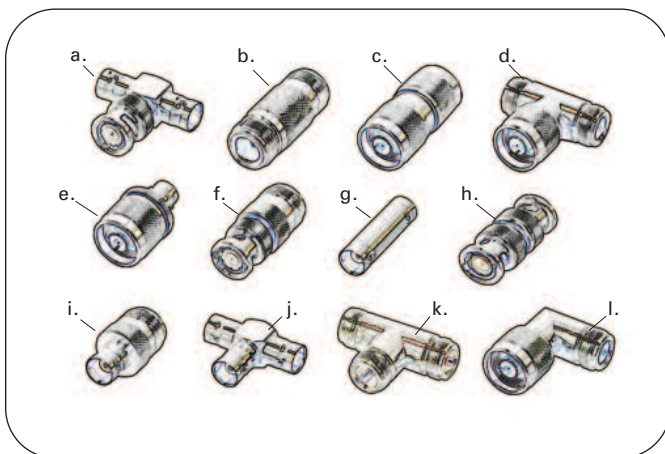

Item	Description	Qty.	Frequency Range	VSWR Max.
a.	BNC Tee female-male-female	1	DC - 4 GHz	N/A
b.	N type female-female	1	DC - 8 GHz	1.30:1 @ 8 GHz
c.	N type male-male	1	DC - 8 GHz	1.30:1 @ 8 GHz
d.	N type Tee female-male-female	1	DC - 8 GHz	N/A
e.	BNC female to N type male	1	DC - 4 GHz	1.30:1 @ 4 GHz
f.	BNC male to N type female	1	DC - 4 GHz	1.30:1 @ 4 GHz
g.	BNC female-female	1	DC - 4 GHz	1.30:1 @ 4 GHz
h.	BNC male-male	1	DC - 4 GHz	1.30:1 @ 4 GHz
i.	BNC female to N type female	1	DC - 4 GHz	1.30:1 @ 4 GHz
j.	BNC Tee female-female-female	1	DC - 4 GHz	N/A
k.	N type Tee female-female-female	1	DC - 8 GHz	N/A
l.	N type Right-Angle male-female	1	DC - 8 GHz	1.35:1 @ 8 GHz

Carrying Cases

Meter Carrying Cases

B+K Precision offers padded cases to protect your valuable instruments. Choose an appropriate case to meet your needs.

- Light weight, durable Cordura nylon
- Protects your instruments
- Room to hold your test leads



LC 24



Meter is not included



Meter is not included



LC 29B

Specifications		models	
	LC 24	LC 29B	
For Models	Mini-Pro® DMM 2405A, 2407A, 2408	Component Testers 810B, 815, 875B, 878, 885, 890, 879 & 830B	
Dimensions	3.75 x 1.5 x 6.75" (95 x 38 x 171mm)	4 x 2.5 x 8" (102 x 64 x 203mm)	
Weight	1.27oz. (36g)	2.47oz. (70g)	
Material	1000D Navy Cordura Laminate Laminate to a 3/16" foam padding, trico backing		

Function Generators Carrying Case



LC 40

Oscilloscopes Carrying Case



LC 210A



Scope is not included

Clamp-On DMM Carrying Case



LC 33

Specifications		models		
	LC 33	LC 40	LC 210A	
For Models	Clamp-on DMM 312A, 313, 316, 325, 330B, 350B, 367A, 369B	Function Generators 4010A, 4011A, 4012A 4017A, 4040A	Oscilloscopes 2120B, 2121, 2125A, 2126A, 2190B, 2522B	
		Bench Top DMM 2831C	Spectrum Analyzers 2630	
Dimensions	5 x 1.75 x 10.5" (127 x 44 x 267mm)	11 x 5.5 x 12" (279 x 140 x 305mm)	15 x 7.5 x 17.5" (381 x 191 x 445mm)	
Weight	3.18 oz. (90g)	1.02 lbs. (470g)	2.36 lbs. (1070g)	
Material	1000D Navy Cordura Laminate to a 3/16" foam padding, trico backing		1000D Navy Cordura 400D nylon packcloth inside to help it encompass the 1/4" foam padding	

Data Acquisition & Recorders

Introducing:



SEFRAM is celebrating its 60th anniversary this year. In 1947 SEFRAM started with the design and production of oscillographic recorders. 60 years on, SEFRAM has become the European leader for recorders & data acquisition systems, a major manufacturer of TV field strength meters and now offers an extensive range of test & measurement instruments.

In 2004 SEFRAM became a wholly owned subsidiary of B&K Precision and serves as its european headquarters.

■ **ISO9001:2000 quality accreditation**

Data Acquisition & Recorders

THE NEW DAS 1400 FAMILY OF PAPERLESS RECORDERS OFFERS UP TO 36 ANALOG INPUTS TO COVER ALL YOUR APPLICATIONS.

The DAS1400 are the latest generation of portable paperless recorders, ideal to measure, record and analyze signals up to 100 kHz.

The wide bandwidth, internal hard disk (40GB) and large LCD screen, together with a new user interface under Linux® offers excellent performance with ease-of-use. Comprehensive interfaces (USB and Ethernet) are built into each recorder.



DAS 1400 : New design

- 6 to 36 analog channels
- Universal input
- DC, AC+DC RMS voltage measurement
- Frequency, thermocouple and PT100 measurement
- 16 logical channels
- 16-bit resolution
- 1Mega sample/s sampling rate
- 100 kHz bandwidth
- 17 automatic measurements
- 12" TFT LCD screen
- 32M word memory
- 40 GB internal hard disk
- Interfaces: USB, Ethernet, XGA
- IEC 61010 – Cat III 600V

EASE OF USE

DAS1400 are the easiest to use recorders on the market today. The concept of previous families has been maintained, but now backed by the Linux operating system.

All parameters are displayed on the screen. With the mouse, you can access and change functions and parameters. A help screen is provided for each function..



PANORAMIC LCD SCREEN

The high resolution LCD screen provides excellent quality real-time graphical display, even in difficult conditions.

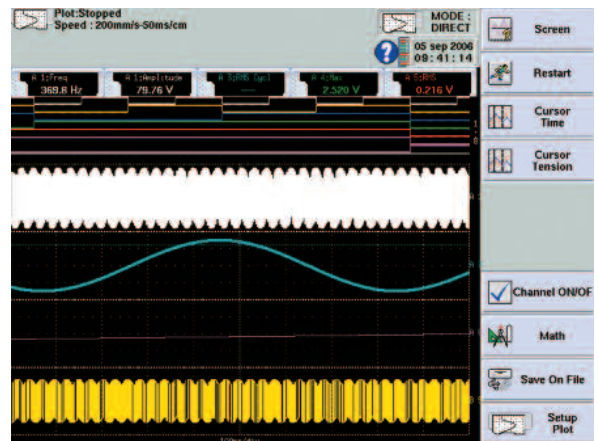

Data Acquisition & Recorders

6 TO 36 ANALOG CHANNELS

The DAS1400 can be configured with 6, 12, 18, 24, 30 or 36 analog channels and 16 logical channels. You can choose between two types of input modules :

- **6 universal inputs: Designed for high speed and high voltage applications**
- **12 multiplexed inputs : designed for temperature and low voltage applications**

The DAS1400 is very flexible. The user can configure or upgrade the recorder for particular applications with up to three modules.

Modules can be added or exchanged without return to the factory.

High flexibility :
you can add yourself
new input boards

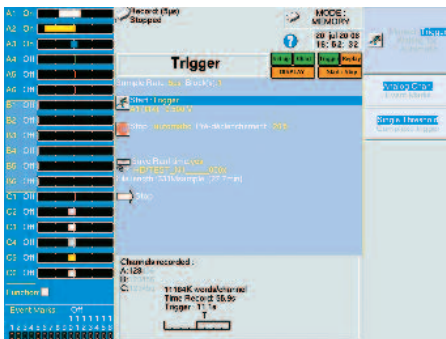
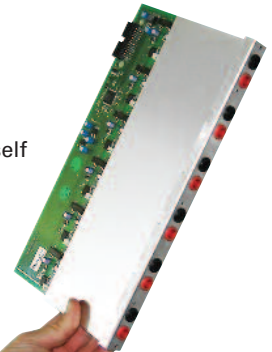

REAL TIME ACQUISITION ON HARD DISK

For long recording, the DAS1400 provides direct acquisition onto the internal hard disk – up to 100kHz for 6 channels simultaneously. Various trigger modes simplify the capture of complex signals: edge, date, alarms, Go-No-Go,...

DATA ANALYSIS

The DAS1400 provides 17 automatic measurements that can be setup to suit your application. Cursors can be associated to zoom mode (zoom in and out) to get the best analysis of your graphs, with exceptional accuracy.

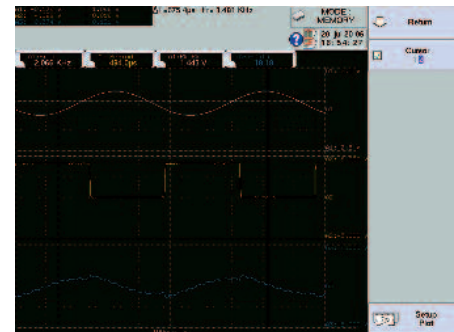

DATA STORAGE AND INTERFACE

The DAS1400 offers various storage options: internal hard disk (40GB), external USB flash memory (USB key), USB storage devices (CD/DVD writer, external hard disk,...). You can save your records and the recorder parameters (setup).

The Ethernet interface provides fast and efficient remote control of the recorder and will allow very fast transfer of data files to personal computers.

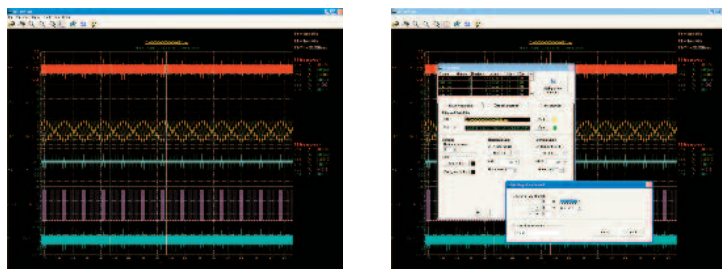

COMPLETE SOFTWARE

SEFRAM View displays graphs on your personal computer as well as export to a spreadsheet (Excel®) or word processor (Word®).

Data Acquisition & Recorders

Specifications		model
		DAS 1400
UNIVERSAL INPUT BOARD		
Channels	6 per board	
VOLTAGE		
DC voltage ranges	1mV to 1000 V	
Max offset	± 5 ranges (except 1000V)	
Accuracy	± 0,1% ± 10 mV ± 0,2% offset	
TRMS AC+DC	200 mV to 500 V	
Bandwidth (-3dB)	5Hz to 500Hz	
Crest factor	2,2	
FREQUENCY		
Sensitivity	300mV rms min.	
Duty cycle	10%	
Frequency range	10Hz to 100 kHz	
Basic accuracy	0,2% of full scale	
Maximum input voltage	± 500VDC or 440V AC (sine)	
TEMPERATURE		
Sensor	Using environnement	Ranges
J	-20°C to 1200°C	20°C to 2000°C
K	-250°C to 1370°C	20°C to 2000°C
T	-200°C to 400°C	20°C to 500°C
S	-50°C to 1760°C	50°C to 2000°C
B	-200°C to 1820°C	50°C to 2000°C
E	-250°C to 1000°C	20°C to 1000°C
N	-250°C to 1300°C	20°C to 1000°C
W5	0 to 2320°C	50°C to 2000°C
Accuracy	Cold junction compensation : ± 1,25°C	
SAMPLING		
Resolution	14 bits	
Sampling rate	1M sample/sec per channel	
Memory length	32M word in segments of up to 128 Blocks	
Triggering	Positive edge, negative edge, on logical input, delay, Go No Go.	
Pre trigger	-100% à +100%	
BANDWIDTH		
Analog input bandwidth (-3dB)	range ≥ 1V: 100kHz range ≤ 50mV: 20kHz min	
Programmable digital filters	10Hz, 100Hz, 1kHz, 10kHz	
Input impedance (DC)	>25M W for range < 1V 1M W for upper ranges	
Input capacitance	150pF typ.	
Maximum input voltage	between one channel and the frame ground ± 500V between 2 terminals of one channel ± 500V Isolation between frame ground and channel > 100MW at 500VDC	
LOGIC INPUT		
Channels	16	
TTL - Max voltage	24V	
Available functions	triggering acquisition on alarm triggering on logical words acquisition in memory mode 4, 8, 16 channels paper trace	
Sensor supply	12 V DC	
Alarms	3 (2 TTL, 1 relay)	

MORE PRODUCTIVITY WITH THE SOFTWARE

Flexpro® software* :

Powerful analysis software with more than 100 functions.

* option

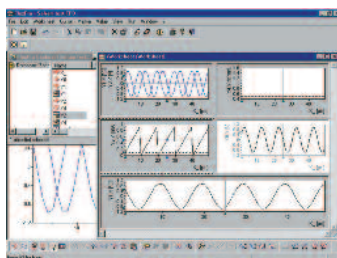

MULTIPLEXED BOARD		
Channels	12 per board	
VOLTAGE		
DC voltage ranges	1mV to 50 V	
Max offset	± 5 ranges	
Accuracy	± 0,1% ± 10µV ± 0,1% offset	
TRMS AC+DC	200mV to 50V.	
Bandwidth (-3dB)	5Hz to 100Hz	
Crest factor	2,2	
TEMPERATURE		
Sensor	Using environnement	Ranges
PT100 (2,3,4 Fils)	-200°C to 850°C	20°C to 1000°C
J	-20°C to 1200°C	20°C to 2000°C
K	-250°C to 1370°C	20°C to 2000°C
T	-200°C to 400°C	20°C to 500°C
S	-50°C to 1760°C	50°C to 2000°C
B	-200°C to 1820°C	50°C to 2000°C
E	-250°C to 1000°C	20°C to 1000°C
N	-250°C to 1300°C	20°C to 1000°C
W5	0 to 2320°C	50°C to 2000°C
Accuracy	Cold junction compensation: ± 1,25°C	
SAMPLING		
Resolution	16 Bits	
Sampling rate	200µs maxi.	
Memory length	32M word in segments of up to 128 Blocks	
Triggering	Positive edge, negative edge, on logical input, delay, Go No Go.	
Pre trigger	-100% à +100%	
BANDWIDTH		
Analog input bandwidth (-3dB)	1kHz à -3dB	
Programmable digital filters	0,1Hz, 1Hz, 10Hz, 100Hz	
Input impedance (DC)	2 M W ranges > 5V	
Input capacitance	10M W (150pF) for other ranges	
Maximum input voltage	between one channel and the frame ground ± 50V between 2 terminals of one channel ± 50V all input are differential, non isolated	
Common mode voltage (max.)	± 5V for ranges < 5V ± 50V for ranges > 5V	
GENERAL SPECIFICATIONS		
DISPLAY		
Display	TFT LCD colored Screen 12 inches f(t) and XY functions Zoom, cursors, dV,dT and zoom between cursors	
Calculation functions	y=ax+b, y=x/+b, y=a√x+b+c, y=ax ² +b, y=(log x)+b, yae ^(x+b) +c +, -, x, / between channels	
Automatic measurements	20 automatic measurements (F, T, Vpp, Tm...)	
STORAGE		
Setup backup	16 named in RAM, unlimited on the hard disk	
Internal hard disk	40 Go.	
Interfaces	4 USB ports, VGA, Ethernet	
MISCELLANEOUS		
Power supply	85VAC to 264 VAC, 47Hz to 63 Hz	
Max. consumption :	60W (non plotting), 230W max.	
Dimensions & weight	384 x 445 x 195 , 7,5 kg	
Operating temperature range	0°C to 40°C	
Storage temperature range :	-20°C to 60°C	
Max. RH	80% (without condensation)	
Safety	IEC1010 CAT III , 600V	

One Year Warranty

Data Acquisition & Recorders

DAS 600 : 6-CHANNELS VALUE-FOR-MONEY RECORDER

Compact, light weight and easy to use, the DAS600 is designed for users requiring a very simple handheld recorder, but without compromising on features. The DAS600 can be your partner for many measurement applications.

- 6 analog channels
- Universal isolated input
- DC, AC+DC RMS voltage measurement
- Frequency, thermocouple
- 16 logical channels
- 14-bit resolution
- 1 Mega sample/s sampling rate
- 100kHz bandwidth
- 17 automatic measurements
- 12" TFT LCD screen
- 32 Mword memory
- 40 GB internal hard disk
- Interfaces: USB, Ethernet, XGA
- IEC 61010 – Cat III 600V



DAS 600 : Design and ergonomy

Specifications		model
		DAS 600
UNIVERSAL INPUT BOARD		
Channels	6	
VOLTAGE		
DC voltage ranges	1 mV to 1000 V	
Max offset	± 5 ranges (except 1000V)	
Accuracy	± 0,1% ± 10 mV ± 0,2% offset	
TRMS AC+DC	200 mV to 500 V	
Bandwidth (-3dB)	5Hz to 500Hz	
Crest factor	2,2	
FREQUENCY		
Sensitivity	300mV rms min.	
Duty cycle	10%	
Frequency range	10Hz to 100kHz	
Basic accuracy	0,2% of full scale	
Maximum input voltage	± 500VDC or 440V AC (sine)	
TEMPERATURE		
Sensor	Using environment	Ranges
J	-20°C to 1200°C	20°C to 2000°C
K	-250°C to 1370°C	20°C to 2000°C
T	-200°C to 400°C	20°C to 500°C
S	-50°C to 1760°C	50°C to 2000°C
B	-200°C to 1820°C	50°C to 2000°C
E	-250°C to 1000°C	20°C to 1000°C
N	-250°C to 1300°C	20°C to 1000°C
W5	0 to 2320°C	50°C to 2000°C
Accuracy	Cold junction compensation : ± 1,25°C	
SAMPLING		
Resolution	14 bits	
Sampling rate	1M sample/sec per channel	
Memory length	32M word in segments of up to 128 Blocks	
Triggering	Positive edge, negative edge, on logical input, delay, Go No Go.	
Pre trigger	-100% à +100%	
BANDWIDTH		
Analog input bandwidth (-3dB)	range ≥ 1V, 100kHz range ≤ 50mV-1V, 50kHz	
Programmable digital filters	10Hz, 100Hz, 1kHz, 10kHz	
Input impedance (DC)	>25M W for range <1V 1M W for upper ranges	
Input capacitance	150pF typ.	
Maximum input voltage	between one channel and the frame ground ± 500V between 2 terminals of one channel ± 500V	
Isolation between frame ground and channel	>100MW at 500VDC	

GENERAL SPECIFICATIONS	
DISPLAY	
Display	TFT LCD colored Screen 12 inches f(t) and XY functions Zoom, cursors, dV,dT and zoom between cursors
Calculation functions	$y=ax+b$, $y=x/+b$, $y=a\sqrt{x+b+c}$, $y=ax^2+b$, $y=(\log x)+b$, $yae^{(k+b)+c}$ + , - , x , / between channels
Automatic measurements	20 automatic measurements (F , T , Vpp , Tm...)
STORAGE	
Setup backup	16 named in RAM, unlimited on the hard disk
Internal hard disk	40 Go.
Interfaces	4 USB ports, VGA, Ethernet
MISCELLANEOUS	
Power supply	85VAC to 264 VAC, 47Hz to 63 Hz
Max. consumption :	60W (non plotting), 230W max.
Dimensions & weight	384 x 445 x 195 , 5 kg
Operating temperature range	0°C to 40°C
Storage temperature range :	-20°C to 60°C
Max. RH	80% (without condensation)
Safety	IEC1010 CAT III , 600V

One Year Warranty

Data Acquisition & Recorders

8440 SERIES : THERMAL RECORDERS WITH 270mm PAPER WIDTH AND UP TO 36 ANALOG CHANNELS.



8440 : new design

- 6 to 36 analog channels
- Universal input
- DC, AC+DC RMS voltage measurement
- Frequency, thermocouple and PT100 measurement
- 16 logical channels
- 16-bit resolution
- 1Mega sample/s sampling rate
- 100kHz bandwidth
- 270mm paper width
- 17 automatic measurements
- 12" TFT LCD screen
- 32Mword memory
- 40 GB internal hard disk
- Go-No-Go mode
- Interfaces: USB, Ethernet, XGA
- IEC 61010 – Cat III 600V

HIGHLY FLEXIBLE PRINTING

The SEFRAM 8440 series built-in printer uses thermal recording paper with 270mm width. To suit your specific and various applications, you can configure and select all printing's parameters, like plotting mode (f(t) or text), paper speed (1mm/h to 200mm/s), number of traces or grid pattern.

For all channels, you can add annotations, specifying the date, the time, the paper speed, the channel names,... It makes your chart more complete and useful, and eases the analysis.

You can plot in real time and memorize simultaneously data and trigger information.

THE CHOICE OF ANALOG INPUT

The new 8440 series can be configured with 2 input boards :

- a universal input board with 6 channels dedicated to DC voltages from 1mV to 1000V, AC voltages, TRMS AC+DC from 200mV to 500 V and temperatures with thermocouples.

- a universal multiplexed board with 12 channels dedicated to temperatures, using thermocouples or PT100 resistor and DC voltages from 0 to 50 V.

With the new "plug-in" system for input boards, you can install your channel extension without factory return of the recorder.



CONVENIENT DATA STOCKAGE AND OFF-LINE ANALYSIS

For long recording, the 8440 series provides direct acquisition onto the internal hard disk up to 100 kHz for 6 channels simultaneously.

Several USB ports are provided for external memory devices (USB memory,...)

The Ethernet interface will allow very fast and easy transfer of your records.

Flexpro® software (optional) offers many possibilities for off-line data analysis and report.

The SeframView software - provided with the recorder - displays graphs on your personal computer as well as export to a spreadsheet (Excel®) or word processor (Word®).

Data Acquisition & Recorders

Specifications		model
		8440
UNIVERSAL INPUT BOARD		
Channels	6 per board	
VOLTAGE		
Direct mode bandwidth	100kHz	
DC voltage ranges	1mV to 1000 V	
Max offset	± 5 ranges (except 1000V)	
Accuracy	± 0,1% ± 10 mV ± 0,2% offset	
TRMS AC+DC	200 mV to 500 V	
Bandwidth (-3dB)	5Hz to 500Hz	
Crest factor	2,2	
FREQUENCY		
Sensitivity	300mV rms min.	
Duty cycle	10%	
Frequency range	10Hz to 100kHz	
Basic accuracy	0,2% of full scale	
Maximum input voltage	± 500VDC or 440V AC (sine)	
TEMPERATURE		
Sensor	Using environnement	Ranges
J	-20°C to 1200°C	20°C to 2000°C
K	-250°C to 1370°C	20°C to 2000°C
T	-200°C to 400°C	20°C to 500°C
S	-50°C to 1760°C	50°C to 2000°C
B	-200°C to 1820°C	50°C to 2000°C
E	-250°C to 1000°C	20°C to 1000°C
N	-250°C to 1300°C	20°C to 1000°C
W5	0 to 2320°C	50°C to 2000°C
Accuracy	Cold junction compensation : ± 1,25°C	
SAMPLING		
Resolution	14 bits	
Sampling rate	1M sample/sec per channel	
Memory length	32M word in segments of up to 128 Blocks	
Triggering	Positive edge, negative edge, on logical	
input, delay, Go No Go.		
Pre trigger	-100% à +100%	
BANDWIDTH		
Analog input bandwidth (-3dB)	range ≥ 1V: 100kHz range 50mV-1V : 50kHz range < 50mV : 20kHz min	
Programmable digital filters	10Hz, 100Hz, 1kHz, 10kHz	
Input impedance (DC)	>25M W for range <1V 1M W for upper ranges	
Input capacitance	150pF typ.	
Maximum input voltage	between one channel and the frame ground ± 500V between 2 terminals of one channel ± 500V	
Isolation between frame ground and channel	> 100MW at 500VDC	
LOGIC INPUT		
Channels	16	
TTL - Max voltage	24V	
Available functions	triggering acquisition on alarm, triggering on logical words acquisition in memory mode, 4, 8, 16 channels paper trace	
Sensor supply	12 V DC	
Alarms	3 (2 TTL , 1 relay)	
RECORDING AND TRACES		
Paper width	270 mm	
Paper speed	direct mode : 1mm/h up to 200 mm/s mixed mode: 1mm/h up to 50 mm/s memory transcription: 10mm/s max, quick advance :100 mm/s external control : 50 mm/s text mode : from 1 line/s to 1line /hour Y axis: 8 dots per mm, X axis: 16 dots per mm up to 50 mm/s and 8 dots for higher speed XY mode: 8 dots per mm	
Resolution and accuracy	Accuracy in relation to graticule: 0,01%	
Graticule	5 pre-programmed graticules	

MULTIPLEXED BOARD		
Channels	12 per board	
VOLTAGE		
DC voltage ranges	1mV to 50 V	
Max offset	± 5 ranges	
Accuracy	± 0,1% ± 10μV ± 0,1% offset	
TRMS AC+DC	200mV to 50V.	
Bandwidth (-3dB)	5Hz to 100Hz	
Crest factor	2,2	
TEMPERATURE		
Sensor	Using environnement	Ranges
PT100 (2,3,4 Fils)	-200°C to 850°C	20°C to 1000°C
J	-20°C to 1200°C	20°C to 2000°C
K	-250°C to 1370°C	20°C to 2000°C
T	-200°C à 400°C	20°C to 500°C
S	-50°C to 1760°C	50°C to 2000°C
B	-200°C to 1820°C	50°C to 2000°C
E	-250°C to 1000°C	20°C to 1000°C
N	-250°C to 1300°C	20°C to 1000°C
W5	0 to 2320°C	50°C to 2000°C
Accuracy	Cold junction compensation: ± 1,25°C	
SAMPLING		
Resolution	16 Bits	
Sampling rate	200μs maxi.	
Memory length	32M word in segments of up to 128 Blocks	
Triggering	Positive edge, negative edge, on logical input, delay, Go No Go.	
Pre trigger	-100% à +100%	
BANDWIDTH		
Analog input bandwidth (-3dB)	1kHz à -3dB	
Programmable digital filters	0,1Hz, 1Hz, 10Hz, 100Hz	
Input impedance (DC)	2 M W calibres > 5V, 10M W for other ranges	
Input capacitance	150pF	
Maximum input voltage	between one channel and the frame ground ± 50V between 2 terminals of one channel ± 50V all input are differential, non isolated	
Common mode voltage (max.)	± 5V for ranges < 5V, ± 50V for ranges > 5V	
GENERAL SPECIFICATIONS		
DISPLAY		
Display	TFT LCD colored Screen 12 inches f(t) and XY functions Zoom, cursors, dV/dT and zoom between cursors	
Calculation functions	y=ax+b , y=x/ +b, y=a√x+b+c, y=ax ² +b, y=(log x)+b, yae ^(a+b) +c +, -, x, / between channels	
Automatic measurements	20 automatic measurements (F, T, Vpp, Tm...)	
STORAGE		
Setup backup	16 named in RAM, unlimited on the hard disk	
Internal hard disk	40 Go.	
Interfaces	RS232, 4 USB ports, VGA, Ethernet	
MISCELLANEOUS		
Power supply	85VAC to 264 VAC, 47Hz to 63 Hz	
Max. consumption :	60W (non plotting), 230W max.	
Dimensions & weight	384 x 445 x 195 , 11 kg	
Operating temperature range	0°C to 40°C	
Storage temperature range :	-20°C to 60°C	
Max. RH	80% (without condensation)	
Safety	IEC 1010 CAT III , 600V	

One Year Warranty

COMPLETE SOFTWARE

SEFRAM View displays graphs on your personal computer as well as export to a spreadsheet (Excel®) or word processor (Word®).

Flexpro® software (option): Powerful analysis software with more than 100 functions.

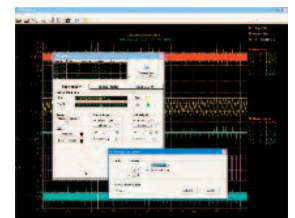

Viewpoint from the President

Managing in the New Global Environment

by Victor E. Tolan

Numerous books and articles address globalization of the economy, but I will specifically address the challenges and methods applied to transform a prototypical "American" test and measurement company that was regionally centered into a modern global market player. Like many companies born in the nineteen fifties (1951), B&K Precision was challenged by the rapid globalization that transformed our industry in the last 25 years. As with other industries, B&K watched its domestic growth as competitors and customers moved operations to Asia. One of the most troubling aspects of this process was watching Asian competitors enter its home market with substantially lower prices.

It's the Customer

The first task for any new manager is to take stock of the situation. Like a poker player, a manager needs to look at the cards dealt before making strategic decisions. The manager examines the situation, evaluates the competitive players, and assesses the markets served. It is vital to understand available assets (financial, employees, patents, brand recognition, channel of distribution, existing products) and liabilities (obsolete equipment, technologies, debt). When this has been accomplished, one is in a position to evaluate the risks for your bets. In other words, a successful company (of any size) must identify its strengths and weaknesses, then decide how to position itself in the market. But, nothing is more important than understanding who are your customers and what are their needs.

B&K Precision had enviable brand recognition, but old designs. Its cost structure was high and, at the time of my acquisition, fewer new products in the pipeline. Over the years, B&K Precision had lost touch with its customers. The company knew how to market and support customers after the sale, but could not keep up with efficient manufacturing and design new products fast enough for the then rapidly changing market.

Have a Roadmap

Once management has a clear understanding of the situation, the next step is to create the vision of where the company will be in 5, 10, 25 years...and chart the roadmap that will take it there. It's like a jigsaw puzzle, but with ever-changing pieces. Therefore, one must start with the clear picture, otherwise it is nearly impossible to put the pieces together. Here is the picture that we formed for B&K Precision: a global company that operates from multiple partner locations, each doing what they do best. Very few companies in the world, regardless of their markets, are good at everything. Companies that are number one in their markets usually excel in only one area. We looked for partners that were strong where we were weak, such as manufacturing and R&D. We found our partners in Taiwan, Romania, India, China, Slovakia and France.

From our roadmap, we had good understanding of the actions necessary to create competitive products and as a result, our global teams worked well together. We conveyed our needs and expectation and our global partners told us what they can do and shared with us their expectations. Our design partners understood the needs we conveyed to them and they produced quality products that were efficient to manufacture. In time, these partners, through outright acquisition or joint venture, joined our group of companies. It is said, "We must walk first before we run."



Once you develop a good relationship and get to know the other company it is easier to combine the teams.

Communications

In any organization, communication is critical. It is essential to have direct and open communication between management and employees, between a company and its customers, between a company and its suppliers, and between the company and its shareholders. In order to communicate effectively managers and employees must all agree to listen (active listening), ask questions, and learn before taking action.

As an international company, we soon discovered that communication and managing went together. Our challenges multiplied with our expansion. We operated in diverse cultures and worked across different time zones. Language barriers were one of the first obstacles that we addressed. Although English is the international language of business, not everyone shares an equal comprehension. Not everyone understands U.S. slang we use in the United States. The internet is a great communication tool, and it is an inherent part of the globalization process. It helped us to communicate with our customers, distributors, and partners around the world. We can share data rapidly at minimal cost. The internet allows introducing a new product faster and offering 24hrs customer support by posting all necessary information on our web site.

Allow Risks

Risk involves the prospect of success or failure. Success is the easy part. Winners have their reward. Failure is another matter. We hear people say that it's OK to make mistakes. Reality often takes another turn. I have found it is important to give permission for people to make mistakes. I encourage people to think out of the box.

An engineer was once asked how he could extend life. He said, "Well, if you cannot make it longer why not make it wider." People have different risk tolerance levels. Calculated risks have a better chance of success than blindly diving into the unknown. The more data is collected before a decision is made better the chances for a desirable outcome. Every opportunity carries risk. The challenge is to minimize the risk through data collection and analysis and in the end take the risk. It is far better to take a risk than to do nothing

Globalization is here

We are a company that does what most companies do, R&D, manufacture, market and service. Unlike other companies our size, our pieces of the puzzle are spread around the globe in one great united B&K family.

Globalization is not a negative word, if you learn how to play the game. Globalization enables businesses to operate more efficiently and at the same time provides the resources to raise the standard of living for employees everywhere. By doing this, we are developing new markets for our products. We are breaking the barriers between countries and people. As the world becomes smaller, it should become a better place for everybody.

B+K PRECISION

has become the preferred choice for thousands of designers, engineers, technicians and service professionals. The reasons are clear; value, function and reliability.

In our latest Catalog, you will find many new products embracing the latest developments in technology. From high current rack mounted power supplies, several new lines of DDS generators and device programmers to our expanding hand held spectrum analyzer family, you can confidently select the instruments and accessories that are just right for you. You can rely on B+K's distributors for their service, assistance and making it easier to buy B+K products. B+K continues setting new standards in performance and value.



22820 Savi Ranch Parkway
Yorba Linda, CA 92887
www.bkprecision.com

