

# Chip resistor networks

## MNR14 (1608×4 size)

### ●Features

- 1) Convex electrodes  
Easy to check the fillet after soldering is finished.
- 2) Small, light, rectangular 4-chip network  
Area ratio is 65% smaller than that of MNR34, while weight ratio has been cut 75%.
- 3) High-density mounting  
Can be mounted even more densely than four 1608 chips (MCR03), and mounting costs are lower.
- 4) Compatible with a wide range of mounting equipment.  
Squared corners make it excellent for mounting using image recognition machines.
- 5) ROHM resistors have approved ISO-9001 certification.  
Design and specifications are subject to change without notice. Carefully check the specification sheet supplied with the product before using or ordering it.

### ●Ratings

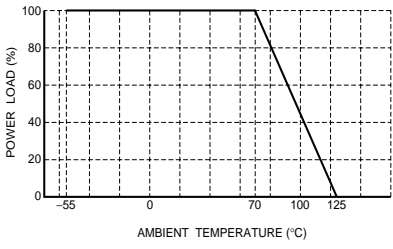
| Item                     | Conditions  | Specifications  |                          |     |
|--------------------------|---|---|--------------------------|-----|
| Rated power              | <p>Power must be derated according to the power derating curve in Figure 1 when ambient temperature exceeds 70°C.</p>  <p style="text-align: center;">Fig.1</p>  | 0.063W (1 / 16W)<br>at 70°C   |                          |     |
| Rated voltage            | <p>The voltage rating is calculated by the following equation. If the value obtained exceeds the limiting element voltage, the voltage rating is equal to the maximum operating voltage.</p> $E = \sqrt{P \times R}$ <p>E: Rated voltage (V)<br/>P: Rated power (W)<br/>R: Nominal resistance (Ω)</p> | <table border="1"> <tr> <td>Limiting element voltage</td> <td>50V</td> </tr> </table> | Limiting element voltage | 50V |
| Limiting element voltage | 50V   |   |                          |     |
| Nominal resistance       | See Table 1.  |   |                          |     |
| Operating temperature    |   | -55°C ~ +125°C  |                          |     |

## Resistors

Jumper type

|                       |                |
|-----------------------|----------------|
| Resistance            | Max. 50mΩ      |
| Rated current         | 1A             |
| Operating temperature | -55°C ~ +125°C |

Table 1

| Resistance tolerance | Resistance range (Ω) | Resistance temperature coefficient (ppm / °C) |
|----------------------|----------------------|---|
| J (±5%)              | 2.2≤R≤10 (E6)        | ±500  |
|                      | 10≤R≤1M (E24)        | ±200  |

●Before using components in circuits where they will be exposed to transients such as pulse loads (short-duration, high-level loads), be certain to evaluate the component in the mounted state. In addition, the reliability and performance of this component cannot be guaranteed if it is used with a steady state voltage that is greater than its rated voltage.

## ●Characteristics

| Item                                     | Guaranteed value   |             | Test conditions (JIS C 5201-1)   |
|--|--|-------------|--|
|  | Resistor type  | Jumper type |  |
| Resistance                               | J : ±5%  | Max. 50mΩ   | JIS C 5201-1 4.5   |
| Variation of resistance with temperature | See Table.1  |             | JIS C 5201-1 4.8<br>Measurement : -55 / +25 / +125°C   |
| Overload                                 | ± (2.0%+0.1Ω)  | Max. 50mΩ   | JIS C 5201-1 4.13<br>Rated voltage (current) ×2.5, 2s.<br>Limiting Element Voltage×2 : 100V                      |
| Solderability                            | A new uniform coating of minimum of 95% of the surface being immersed and no soldering damage. |             | JIS C 5201-1 4.17<br>Rosin-Ethanol (25%WT)<br>Soldering condition : 235±5°C<br>Duration of immersion : 2.0±0.5s. |
| Resistance to soldering heat             | ± (1.0%+0.05Ω)<br>No remarkable abnormality on the appearance.                                 | Max. 50mΩ   | JIS C 5201-1 4.18<br>Soldering condition : 260±5°C<br>Duration of immersion : 10±1s.                             |
| Rapid change of temperature              | ± (1.0%+0.05Ω)   | Max. 50mΩ   | JIS C 5201-1 4.19<br>Test temp. : -55°C~+125°C 5cyc  |
| Damp heat, steady state                  | ± (3.0%+0.1Ω)  | Max. 50mΩ   | JIS C 5201-1 4.24<br>40°C, 93%RH<br>Test time : 1,000h~1,048h  |
| Endurance at 70°C                        | ± (3.0%+0.1Ω)  | Max. 50mΩ   | JIS C 5201-1 4.25.1<br>Rated voltage (current), 70°C<br>1.5h : ON - 0.5h : OFF<br>Test time : 1,000h~1,048h      |
| Endurance                                | ± (3.0%+0.1Ω)  | Max. 50mΩ   | JIS C 5201-1 4.25.3<br>125°C<br>Test time : 1,000h~1,048h  |
| Resistance to solvent                    | ± (1.0%+0.05Ω)   | Max. 50mΩ   | JIS C 5201-1 4.29<br>23±5°C, Immersion cleaning, 5±0.5min.<br>Solvent : 2-propanol                               |
| Bend strength of the end face plating    | ± (1.0%+0.05Ω)<br>Without mechanical damage such as breaks.                                    | Max. 50mΩ   | JIS C 5201-1 4.33  |

Resistors

●External dimensions (Units : mm)

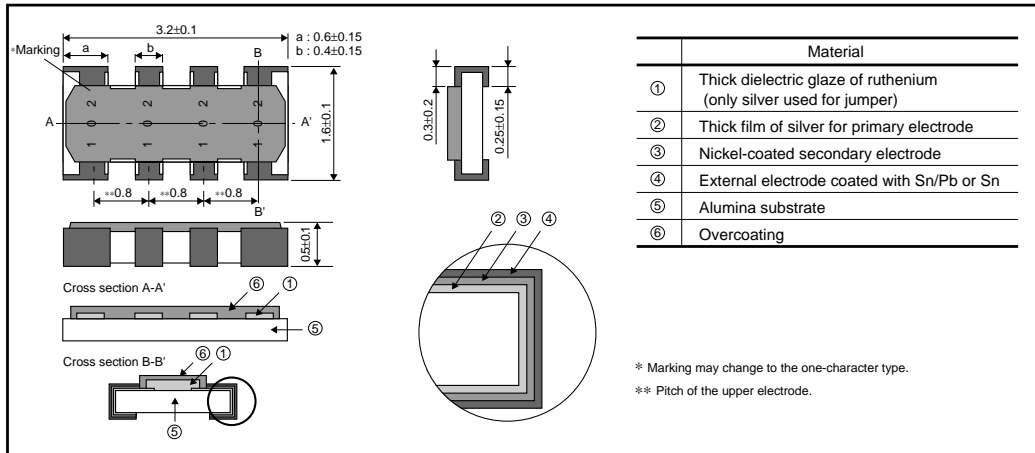

●Equivalent circuit

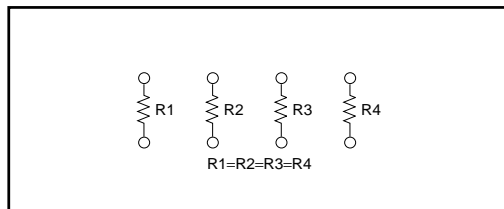

●Packaging

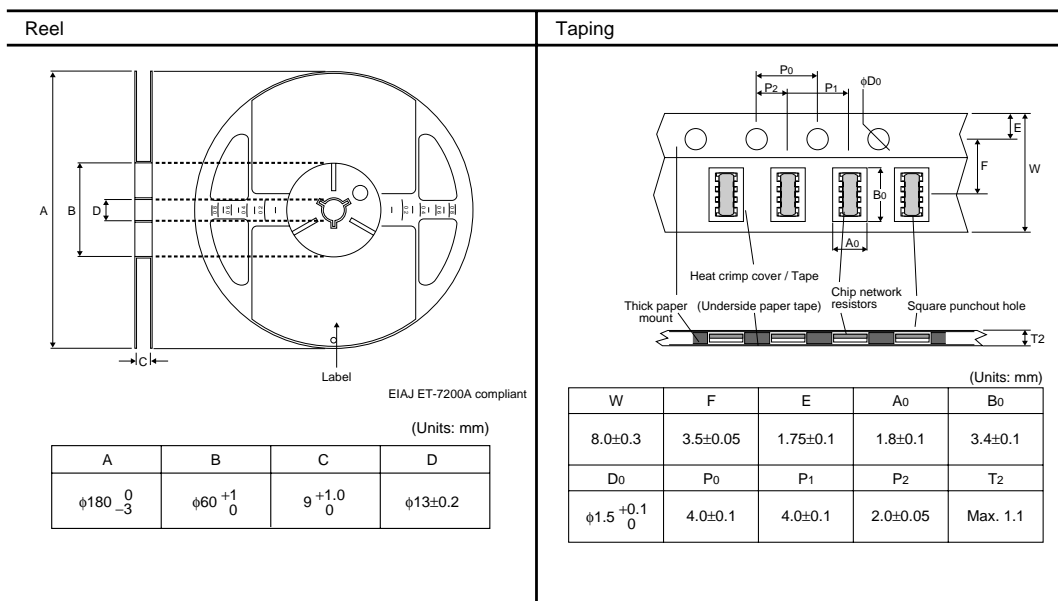

Resistors

● Product designation

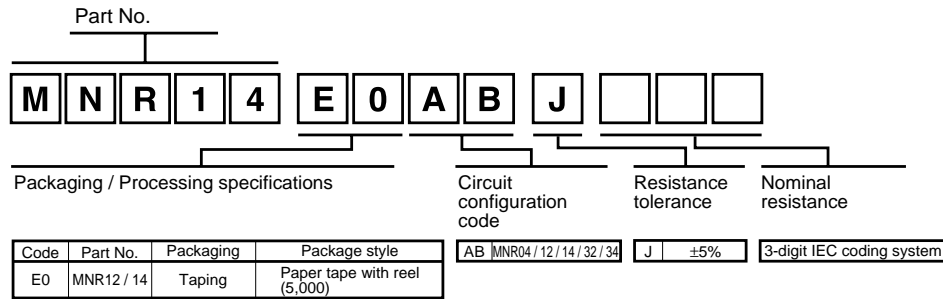

● Electrical characteristics

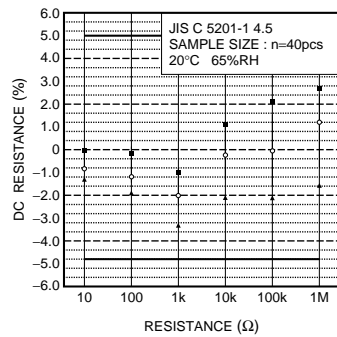

Fig.2 Resistance

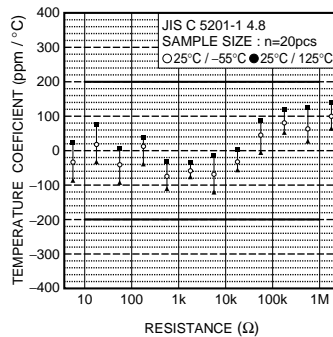

Fig.3 Variation resistance with temperature

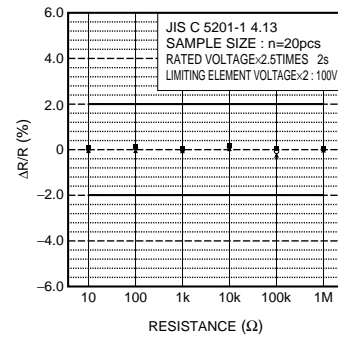

Fig.4 Overload

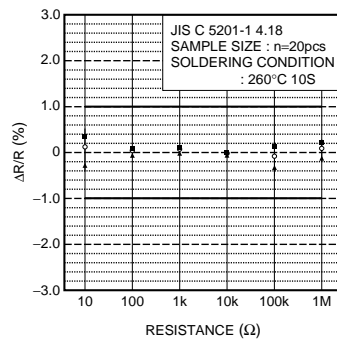

Fig.5 Resistance to soldering heat

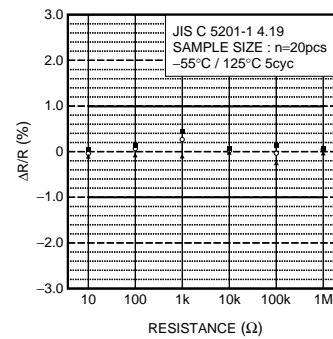

Fig.6 Rapid change of temperature

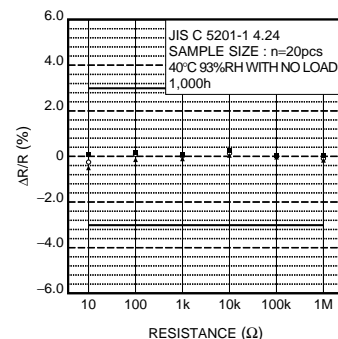

Fig.7 Damp heat, steady state

Resistors

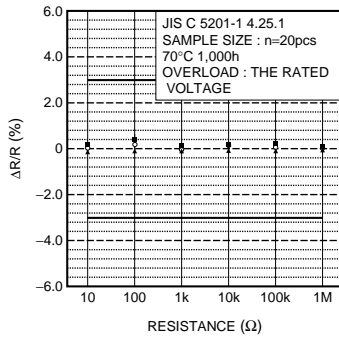

Fig.8 Endurance at 70°C

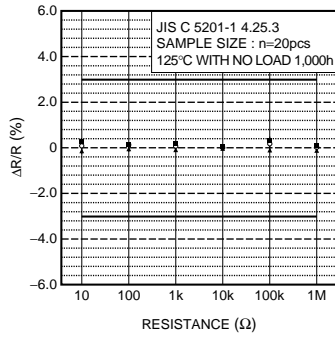

Fig.9 Endurance

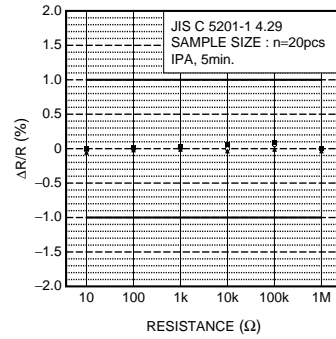

Fig.10 Resistance to solvents