

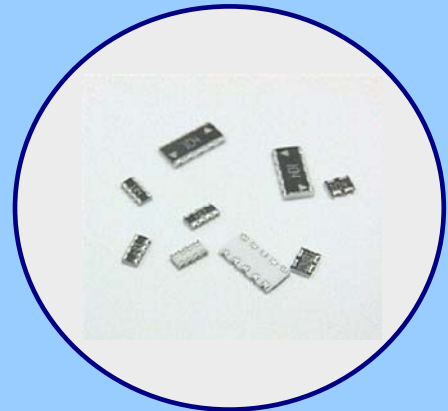

**FEATURES**

- **Low Cost**
- **Thick Film Technology**
- **High Density Packaging**
  - Up to 30% less space per resistor than 0603 chip resistors
  - Up to 75% less space per resistor than 0805 chip resistors
- Low Profile; can be used in PCMCIA cards
- Leadless Surface Mount Construction
- Concave or Convex Terminations
- Solder Coated Nickel Barrier Pads
- Isolated and Bussed Circuits
- Resistor Arrays Require Fewer Placements Than Discrete Components
- Tape and Reel Packaging
- **RoHS Compliant in Accordance with EU Directive 2005/95/EC**
  - Lead-Free Termination Finish
  - Exemption 5 for Pb in glass material and resistor elements



**ORDERING INFORMATION**

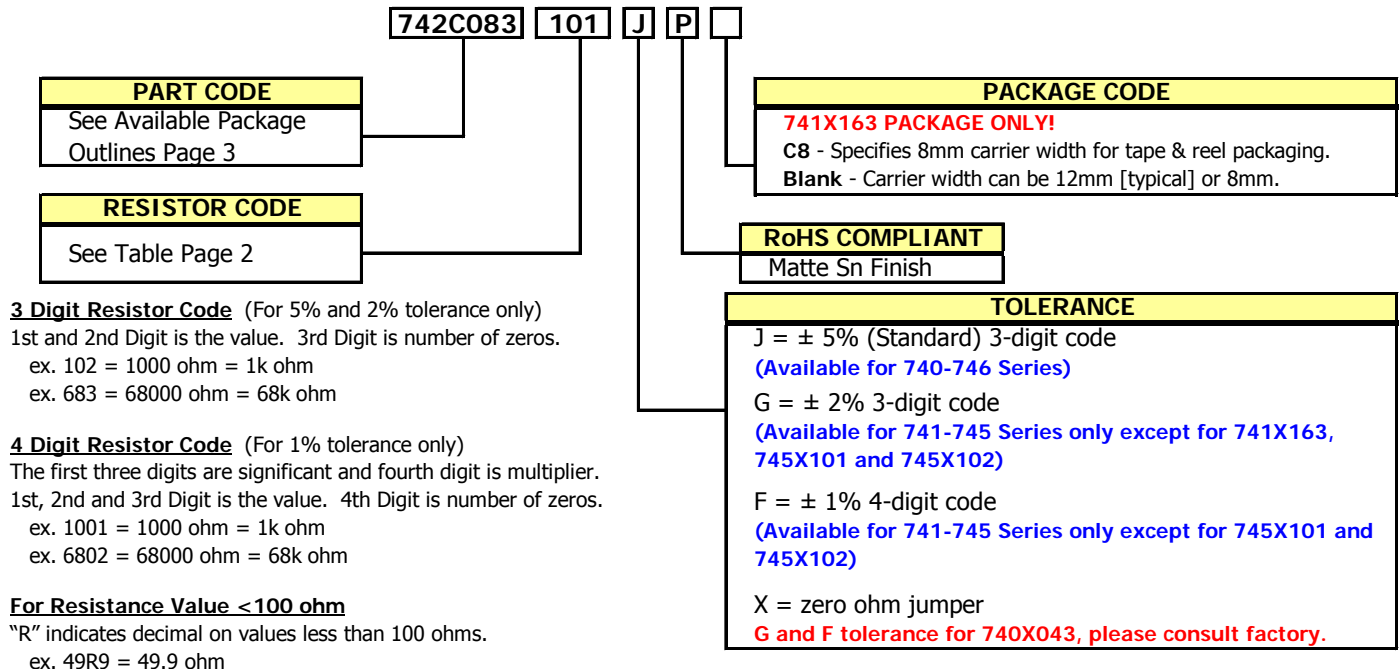

**Part Number Examples**

Value\Tolerance	3-Digit Code		4-Digit Code
	J (±5%)	G (±2%)	F (±1%)
10 Ohm	742C083100JP	742C083100GP	742C08310R0FP
49.9 Ohm	Not Available	Not Available	742C08349R9FP
120 Ohm	742C083121JP	742C083121GP	742C0831200FP
1K Ohm	742C083102JP	742C083102GP	742C0831001FP
68 Kohm	742C083683JP	742C083683GP	742C0836802FP

**Not all performance combinations and resistor values may be available.  
Contact your local CTS Representative or CTS Customer Service for availability.**

**ORDERING INFORMATION**

**AVAILABLE RESISTOR VALUES & EIA CODES**

Ohms	Code	Ohms	Code	Ohms	Code	Ohms	Code	Ohms	Code	Ohms	Code
0	000X	68	680	510	511	3.9K	392	30.0K	303	220K	224
10	100	75	750	560	561	4.3K	432	33.0K	333	240K	244
11	110	82	820	620	621	4.7K	472	36.0K	363	270K	274
12	120	91	910	680	681	5.1K	512	39.0K	393	300K	304
13	130	100	101	750	751	5.6K	562	43.0K	433	330K	334
15	150	110	111	820	821	6.2K	622	47.0K	473	360K	364
16	160	120	121	910	911	6.8K	682	51.0K	513	390K	394
18	180	130	131	1.0K	102	7.5K	752	56.0K	563	430K	434
20	200	150	151	1.1K	112	8.2K	822	62.0K	623	470K	474
22	220	160	161	1.2K	122	9.1K	912	68.0K	683	510K	514
24	240	180	181	1.3K	132	10.0K	103	75.0K	753	560K	564
27	270	200	201	1.5K	152	11.0K	113	82.0K	823	620K	624
30	300	220	221	1.6K	162	12.0K	123	91.0K	913	680K	684
33	330	240	241	1.8K	182	13.0K	133	100K	104	750K	754
36	360	270	271	2.0K	202	15.0K	153	110K	114	820K	824
39	390	300	301	2.2K	222	16.0K	163	120K	124	910K	914
43	430	330	331	2.4K	242	18.0K	183	130K	134	1M	105
47	470	360	361	2.7K	272	20.0K	203	150K	154		
51	510	390	391	3.0K	302	22.0K	223	160K	164		
56	560	430	431	3.3K	332	24.0K	243	180K	184		
62	620	470	471	3.6K	362	27.0K	273	200K	204		

**TAPE & REEL INFORMATION**

Reel Diameter 7"	740X043	741X043 741C083 741X083	742C043 742C083 742X083	741X163	742C163	743C043 744C043	743C083 744C083	745C101 745C102	745X101 745X102	746X101
Parts Per Reel	10,000	10,000	5,000	5,000	4,000	4,000	4,000	4,000	4,000	5,000
Pitch	2mm	2mm	4mm	4mm	4mm	4mm	4mm	4mm	4mm	4mm
Carrier Width	8mm	8mm	8mm	8mm * 12mm	12mm	8mm	12mm	12mm	12mm	8mm
Material	Paper	Paper	Paper	Paper	Plastic	Plastic	Plastic	Plastic	Plastic	Paper

\* See Ordering Information for package code indicator.

**ELECTRICAL & ENVIRONMENTAL CHARACTERISTICS**

Series	PCB Area (in <sup>2</sup> ) Per Resistor	Circuit Type	Resistance Range, Ohms	70°C Power Per Resistor *	Maximum Operating Voltage
740	0.0008	Isolated	10 - 1M	.031W	12.5V
741	0.0015	Isolated	10 - 1M	.063W	25V
742	0.0037	Isolated	10 - 1M	.063W	50V
743	0.0071	Isolated	10 - 1M	.100W	100V
744	0.0094	Isolated	10 - 1M	.125W	200V
745	0.0058	Bussed	33 - 470K	.063W	50V
746	0.0013	Bussed	33 - 100K	.031W	25V

Resistance Tolerance: Std. ±5% or 0.5Ω (whichever is greater).

See Ordering Information for other options available.

Operating Temperature Range: -55°C to +125°C.

Temperature Coefficient: ±200 ppm/°C.

\* Total Rated Package Power equals total number of resistors times rated Power per Resistor

Test	Maximum Delta R			Test Description
	740	741	742-746	
Thermal Cycle	1.00%	1.00%	1.00%	5 Cycles -55°C to +125°C
Short Time Overload	2.00%	2.50%	1.00%	2½ Times Rated Working Voltage for 5 Seconds
Moisture Resistance	2.00%	5.00%	2.00%	240 Hours 10% rated load, -10°C to +65°C, 90% R.H.
High Temperature Exposure	3.00%	1.00%	1.00%	1000 Hours, no load, +125°C
Load Life	3.00%	5.00%	2.00%	1000 Hours @ +70°C, rated load
Resistance to Solder Heat	1.00%	2.50%	1.00%	10 Seconds @ +260°C solder
Resistance to Solvents				Isopropyl alcohol, Freon TMC
Solderability				RMA Flux, +230°C, 5 Seconds dip, 95% coverage

**PACKAGE OUTLINES**

**CONCAVE TERMINATION – TYPE C**

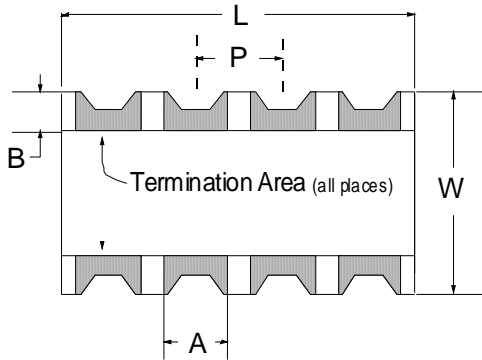

**CONVEX TERMINATION – TYPE X**

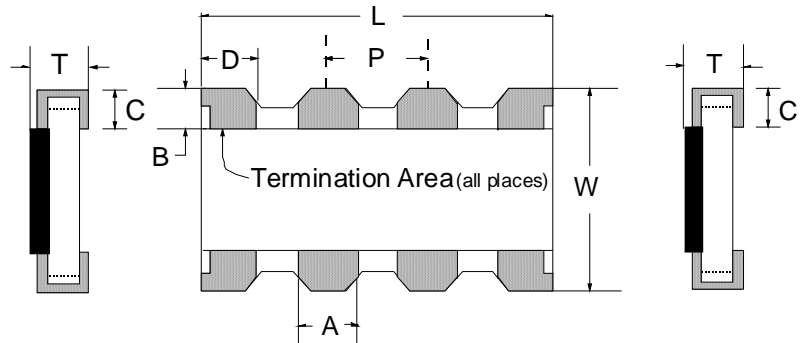

**NOTES**

1. Termination pads (e3). Barrier plating is nickel (Ni) with Matte tin (Sn) finish.
2. Reflow conditions per JEDEC-J-STD-020, +260°C maximum.

Part Code	Configuration	# Pads	# Res.	Circuit	Dimensions [mm/inch]								
					L	W	P	T	A	B	C	D	
740X043	0201 x 2	4	2	Isolated	0.80 ±0.10 0.031 ±0.004	0.60 ±0.10 0.024 ±0.004	0.50 ±0.05 0.020 ±0.002	0.35 ±0.10 0.014 ±0.004	0.35 ±0.10 0.014 ±0.004	0.20 ±0.10 0.008 ±0.004	0.15 ±0.10 0.006 ±0.004	N/A	
741X043	0402 X 2	4	2	Isolated	1.00 ±0.10 0.039 ±0.004	1.00 ±0.10 0.039 ±0.004	0.65 ±0.10 0.026 ±0.004	0.375 ±0.125 0.0147 ±0.005	0.33 ±0.10 0.013 ±0.004	0.20 ±0.10 0.008 ±0.004	0.38 Max. 0.015 Max.	N/A	
741X083	0402 X 4	8	4	Isolated	2.00 ±0.10 0.079 ±0.004		0.50 ±0.10 0.020 ±0.004		0.30 ±0.15 0.012 ±0.006				
741C083	0402 X 4	8	4	Isolated	3.80 ±0.10 0.150 ±0.004	1.60 ±0.10 0.063 ±0.004	0.50 ±0.10 0.020 ±0.004	0.45 ±0.10 0.018 ±0.004	0.29 ±0.12 0.011 ±0.005	0.30 ±0.10 0.012 ±0.004	0.30 ±0.10 0.012 ±0.004	0.30 ±0.10 0.012 ±0.004	
741X163	0402 X 8	16	8	Isolated					0.40 ±0.15 0.016 ±0.006				
742C043	0603 X 2	4	2	Isolated	1.60 ±0.20 0.063 ±0.008	1.60 ±0.20 0.063 ±0.008	0.80 ±0.05 0.032 ±0.002	0.60 ±0.10 -0.25 0.024 +0.004 -0.010	0.50 ±0.15 0.020 ±0.006	0.30 ±0.20 0.012 ±0.008	0.30 ±0.15 0.012 ±0.006	N/A	
742X083	0603 X 4	8	4	Isolated	3.20 ±0.20 0.126 ±0.008						0.40 ±0.15 0.016 ±0.006		
742C083	0603 X 4	8	4	Isolated	6.40 ±0.20 0.252 ±0.008	2.00 ±0.20 0.079 ±0.008	1.27 ±0.05 0.050 ±0.002	0.60 ±0.10 0.024 ±0.004	0.80 ±0.10 0.031 ±0.006	0.40 ±0.20 0.016 ±0.008	0.40 ±0.15 0.016 ±0.006	N/A	
742C163	0603 X 8	16	8	Isolated	2.54 ±0.20 0.100 ±0.008								
743C043	0805 X 2	4	2	Isolated	5.08 ±0.30 0.200 ±0.012	3.20 ±0.20 0.126 ±0.008	1.27 ±0.05 0.050 ±0.002	0.60 ±0.10 0.024 ±0.004	0.80 ±0.10 0.031 ±0.006	0.50 ±0.20 0.020 ±0.008	0.50 ±0.15 0.020 ±0.006	N/A	
743C083	0805 X 4	8	4	Isolated	2.54 ±0.20 0.100 ±0.008								
744C043	1206 X 2	4	2	Isolated	5.08 ±0.30 0.200 ±0.012	3.20 ±0.20 0.126 ±0.008	1.27 ±0.05 0.050 ±0.002	0.60 ±0.10 0.024 ±0.004	0.80 ±0.10 0.031 ±0.006	0.50 ±0.20 0.020 ±0.008	0.50 ±0.15 0.020 ±0.006	N/A	
744C083	1206 X 4	8	4	Isolated	6.40 ±0.20 0.252 ±0.008								
745C101	-	10	8	Bussed	6.40 ±0.20 0.252 ±0.008	3.20 ±0.20	1.27 ±0.05	0.60 ±0.10	0.90 ±0.15	0.50 ±0.20	0.50 ±0.15	1.10 ±0.15	N/A
745C102	-	10	8	Bussed	0.252 ±0.008	0.126 ±0.008	0.050 ±0.002	0.024 ±0.004	0.035 ±0.006	0.020 ±0.008	0.020 ±0.006	0.043 ±0.006	
745X101	-	10	8	Bussed	3.30 ±0.10 0.130 ±0.004	1.65 ±0.15 0.065 ±0.006	0.64 ±0.05 0.025 ±0.002	0.60 ±0.10 0.024 ±0.004	0.35 ±0.05 0.014 ±0.002	0.40 ±0.10 0.016 ±0.004	0.45 ±0.10 0.018 ±0.004	0.50 ±0.05 0.020 ±0.002	

**RECOMMENDED LAND PATTERNS**

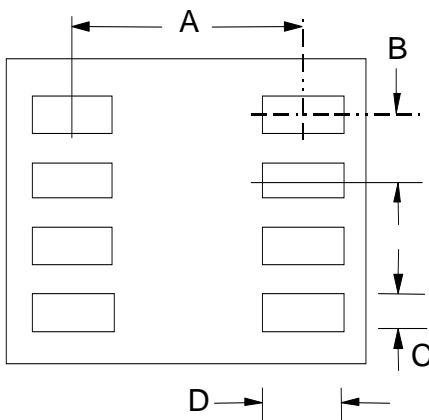

SERIES	DIMENSIONS [mm/in]			
	A	B	C	D
740	0.600	0.500	0.300	0.300
	0.023	0.019	0.012	0.012
741X043	1.000	0.650	0.330	0.500
	0.039	0.026	0.013	0.020
741X083	1.000	0.500	0.300	0.500
	0.039	0.020	0.012	0.020
741C083	1.000	0.500	0.280	0.500
	0.039	0.020	0.011	0.020
741X163	1.600	0.500	0.300	0.800
	0.063	0.020	0.012	0.031
742	1.600	0.800	0.500	0.900
	0.063	0.032	0.020	0.035
743	2.000	1.270	0.800	1.000
	0.079	0.050	0.031	0.039
744	3.200	1.270	0.800	1.300
	0.126	0.050	0.031	0.051
745	3.200	1.270	0.900	1.300
	0.126	0.050	0.035	0.051
746	1.650	0.640	0.350	0.800
	0.065	0.025	0.014	0.032

**CIRCUIT TYPES**



**740X043**  
2 Resistors  
4 Terminations

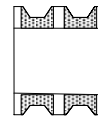

**744C043**  
2 Resistors  
4 Terminations

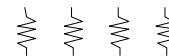
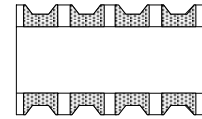

**744C083**  
4 Resistors  
8 Terminations

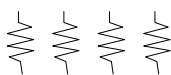
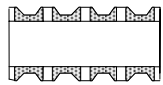

**741C083**  
4 Resistors  
8 Terminations



**741X043**  
2 Resistors  
4 Terminations

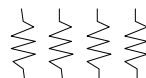
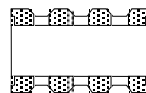

**741X083**  
4 Resistors  
8 Terminations

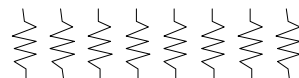
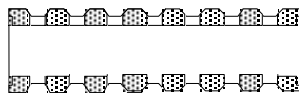

**741X163**  
8 Resistors  
16 Terminations

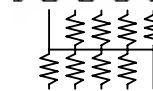

**745C101**  
8 Resistors  
10 Terminations

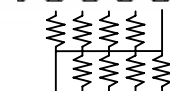
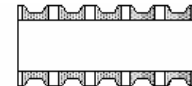

**745C102**  
8 Resistors  
10 Terminations

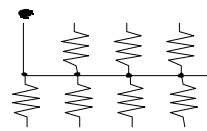
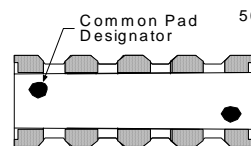

**745X101**  
8 Resistors  
10 Terminations

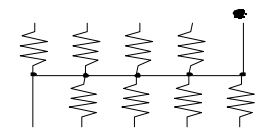
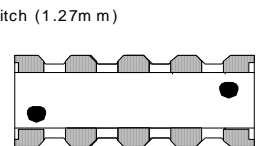

**745X102**  
8 Resistors  
10 Terminations

Note: The Marking Concept for Convex and Concave Series 745 is Different.



**742C043**  
2 Resistors  
4 Terminations

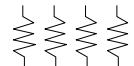
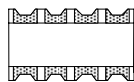

**742C083**  
4 Resistors  
8 Terminations

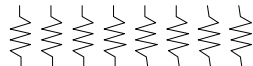
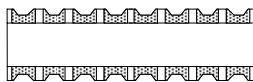

**742C163**  
8 Resistors  
16 Terminations

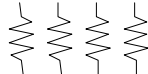
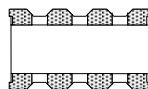

**742X083**  
4 Resistors  
8 Terminations

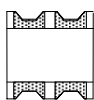

**743C043**  
2 Resistors  
4 Terminations

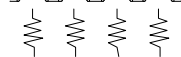
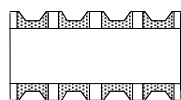

**743C083**  
4 Resistors  
8 Terminations

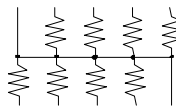
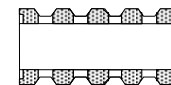

**746X101**  
8 Resistors  
10 Terminations