

## IR21571 Ballast Control IC Design Kit

### Features

- Drives: 1 x 32W T8 Lamp (IRPLLNR2U)  
1 x 36W T8 Lamp (IRPLLNR2)
- Input: 90-140VAC/60Hz (IRPLLNR2U)  
185-265VAC/50Hz (IRPLLNR2)
- High Power Factor/Low THD
- High Frequency Operation (42kHz)
- Lamp Filament Preheating
- Lamp Fault Protection with Auto-Restart
- Brownout Protection
- IR21571 HVIC Ballast Controller

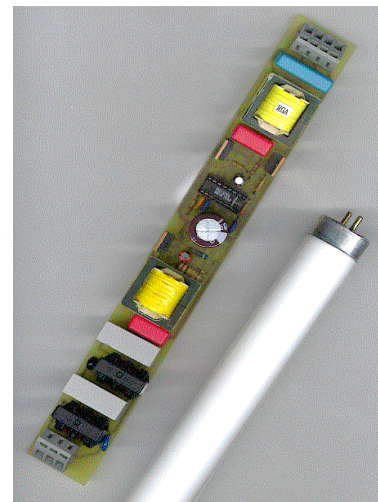

### Description

The IRPLLNR2 is a high efficiency, high power factor, fixed output electronic ballast designed for driving rapid start fluorescent lamp types. The design contains an EMI filter, active power factor correction and a ballast control circuit using the IR21571. This demo board is intended to ease the evaluation of the IR21571 Ballast Control IC, demonstrate PCB layout techniques and serve as an aid in the development of production ballast's using the International Rectifier IR21571.

### Ballast Block Diagram

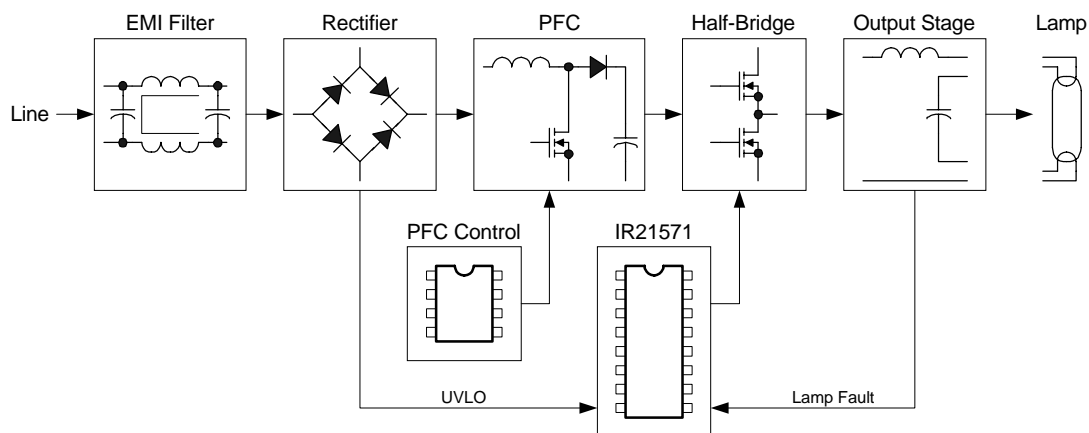

## Electrical Characteristics

Parameter	Units	Value (IRPLLNR2)	Value (IRPLLNR2U)
Lamp Type		36W T8	32W T8
Input Power	[W]	36	32
Input Current	[Arms]	0.300	0.300
Preheat Mode Frequency	[kHz]	44	44
Preheat Mode Lamp Voltage	[Vrms]	220	220
Preheat Time	[s]	0.9	0.6
Ignition Ramp Mode Frequency	[kHz]	38	38
Run Mode Frequency	[kHz]	42	42
Lamp Run Current	[Arms]	0.34	0.34
Input AC Voltage Range	[VACrms]	185..255/50..60Hz	90..140/50..60Hz
Input DC Voltage Range	[VDC]	250..350	100..180
Power Factor		0.98	0.99
Total Harmonic Distortion	[%]	<15	<10
Maximum Output Voltage	[Vpk]	600	600

Note: Measurements performed with input AC line voltage = 120Vrms (IRPLDIM1U)  
230Vrms (IRPLDIM1)

## Fault Protection Characteristics

Fault	Ballast	Restart Operation
Line voltage low	Deactivates	Increase line voltage
Upper filament broken	Deactivates	Lamp exchange
Lower filament broken	Deactivates	Lamp exchange
Failure to ignite	Deactivates	Lamp exchange
Open circuit (no lamp)	Deactivates	Lamp exchange

## Functional Description

### Overview

The IRPLDIM1 Demo Board consists of an EMI filter, an active power factor correction front end, a ballast control section and a resonant lamp output stage. The active power factor correction section is a boost converter operating in critical mode conduction, free-running frequency mode. The ballast control section provides frequency modulation control of a traditional RCL lamp resonant output circuit and is easily adaptable to a wide variety of lamp types. The ballast control section also provides the necessary circuitry to perform closed-loop dimming, lamp fault detection, shutdown and auto-restart. All functional descriptions refer to the IRPLDIM1 schematic diagram.

IRPLLNR2/IRPLLNR2U  
Schematic Diagram

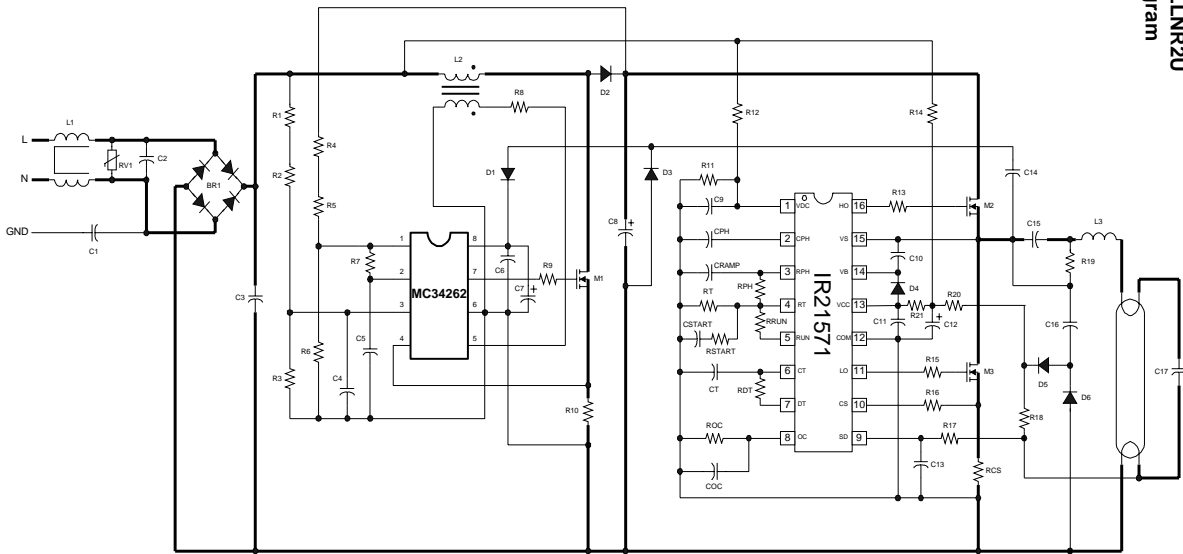

**Note:** Thick traces represent high-frequency, high-current paths. Lead lengths should be minimized to avoid high-frequency noise problems

## IRPLLNR2U Bill Of Materials

Lamp type: T8/32W

Line Input Voltage: 90..140 VAC/50..60 Hz

Note: Different lamp types require different frequency programming components.

Item #	Qt	Manufacturer	Part Number	Description	Reference
1	1	International Rectifier	DF10S	Bridge Rectifier, 1A 1000V	BR1
2	1	Roederstein	WY0222MCMBF0K	Capacitor, 2.2nF 275 VAC Y Cap	C1
3	1	Roederstein	F1772433-2200	Capacitor, 0.33uF 275 VAC	C2
4	1	Wima	MKP10	Capacitor, 0.01uF 400 VDC	C3
5	3	Panasonic	ECU-V1H103KBM	Capacitor, 0.01uF SMT 1206	C4, CRAMP, CSTART
6	3	Panasonic	ECJ-3YB1E474K	Capacitor, 0.47uF SMT 1206	C5, C6, C13
7	5	Panasonic	ECU-V1H104KBM	Capacitor, 0.1uF SMT 1206	C9,CPH, COC, C10, C11
8	1	Panasonic	EEU-EB2V100	Capacitor, 10uF 350VDC 105C	C8
9	1	Panasonic	ECU-V1H471KBM	Capacitor, 470pF SMT 1206	CT
10	1	Panasonic	ECE-A1HGE010	Capacitor, 1uF 50VDC 105C	C12
11	1	Vitramon	1812A152KXE	Capacitor, 1.5nF 1KV SMT 1812	C14
12	1	Wima	MKP10	Capacitor, 0.1uF 400VDC	C15
13	1	Vitramon	1812A102KXE	Capacitor, 1nF 1KV SMT 1812	C16
14	1	Panasonic	ECW-H16103JV	Capacitor, 0.01uF 1.6KV	C17
15	1	Panasonic	ECU-V1H101KBM	Capacitor, 100pF SMT 1206	CCS
16	3	Diodes	LL4148DICT-ND	Diode, 1N4148 SMT DL35	D1, D5, D6
17	2	International Rectifier	10BF60	Diode, SMT SMB	D2, D4
18	1	Diodes	ZMM5250BCT	Diode, Zener , 20V SMT DL35	D3
19	1	Motorola	MC34262	IC, Power Factor Controller	IC1
20	1	International Rectifier	IR21571	IC, Ballast Driver	IC2
21	1	Panasonic	ELF-15N007A	EMI Inductor, 1X10mH 0.7Apk	L1
22	1	RG-Allen		PFC Inductor, 2.0mH 2.0Apk	L2
23	1	RG-Allen		Inductor, 2.0mH 2.0Apk	L3
24	3	International Rectifier	IRF730	Transistor, MOSFET	M1, M2, M3
25	5	Panasonic	ERJ-8GEYJ680K	Resistor, 680K ohm SMT 1206	R1, R2, R4, R5, R17
26	1	Panasonic	ERJ-8GEYJ10K	Resistor, 10K ohm SMT 1206	R3
27	1	Panasonic	ERJ-8GEYJ12K	Resistor, 12K ohm SMT 1206	R6
28	1	Panasonic	ERJ-8GEYJ100K	Resistor, 100K ohm SMT 1206	R7
29	3	Panasonic	ERJ-8GEYJ22K	Resistor, 22K ohm SMT 1206	R8, RSTART, RT
30	3	Panasonic	ERJ-8GEYJ22	Resistor, 22 ohm SMT 1206	R9, R13, R15
31	1	Dale	CW-1/2	Resistor, 0.5 ohm ½ watt	R10
32	1	Panasonic	ERJ-8GEYJ130K	Resistor, 130K ohm SMT 1206	R11
33	1	Yageo	2.2MQBK-ND	Resistor, 2.2megohm ¼ watt	R12
34	1	Dale	CW-1/2	Resistor, 0.68 ohm ½ watt	RCS
35	1	Panasonic	ERJ-8GEYJ5.6K	Resistor, 5.6K ohm SMT 1206	RDT
36	1	Panasonic	ERJ-8GEYJ30K	Resistor, 30K ohm SMT 1206	ROC
37	1	Panasonic	ERJ-8GEYJ91K	Resistor, 91K ohm SMT 1206	RPH
38	1	Panasonic	ERJ-8GEYJ150K	Resistor, 150K ohm SMT 1206	RRUN
39	1	Yageo	390KQBK-ND	Resistor, 390K ohm ¼ watt	R14
40	1	Panasonic	ERJ-8GEYJ1K	Resistor, 1K ohm SMT 1206	R16
41	1	Panasonic	ERJ-8GEYJ2.2M	Resistor, 2.2megohm SMT 1206	R18
42	1	Yageo	100KQBK-ND	Resistor, 100K ohm ¼ watt	R19
43	1	Panasonic	ERZ-V05D471	Transient Suppressor	RV1
44	2	Panasonic	ERJ-8GEYJ10	Resistor, 10 ohm SMT 1206	R20, R21
Total	67				

## IRPLLNR2 Bill Of Materials

Lamp type: T8/36W

Line Input Voltage: 180..255 VAC/50..60 Hz

Note: Different lamp types require different frequency programming components.

Item #	Qt	Manufacturer	Part Number	Description	Reference
1	1	International Rectifier	DF10S	Bridge Rectifier, 1A 1000V	BR1
2	1	Roederstein	WY0222MCMBF0K	Capacitor, 2.2nF 275 VAC Y Cap	C1
3	1	Roederstein	F1772433-2200	Capacitor, 0.33uF 275 VAC	C2
4	1	Wima	MKP10	Capacitor, 0.01uF 400 VDC	C3
5	3	Panasonic	ECU-V1H103KBM	Capacitor, 0.01uF SMT 1206	C4, CRAMP, CSTART
6	3	Panasonic	ECJ-3YB1E474K	Capacitor, 0.47uF SMT 1206	C5, C6, C13
7	5	Panasonic	ECU-V1H104KBM	Capacitor, 0.1uF SMT 1206	C9,CPH, COC, C10, C11
8	1	Panasonic	EEU-EB2V100	Capacitor, 10uF 350VDC 105C	C8
9	1	Panasonic	ECU-V1H471KBM	Capacitor, 470pF SMT 1206	CT
10	1	Panasonic	ECE-A1HGE010	Capacitor, 1uF 50VDC 105C	C12
11	1	Vitramon	1812A152KXE	Capacitor, 1.5nF 1KV SMT 1812	C14
12	1	Wima	MKP10	Capacitor, 0.1uF 400VDC	C15
13	1	Vitramon	1812A102KXE	Capacitor, 1nF 1KV SMT 1812	C16
14	1	Panasonic	ECW-H16103JV	Capacitor, 0.01uF 1.6KV	C17
15	1	Panasonic	ECU-V1H101KBM	Capacitor, 100pF SMT 1206	CCS
16	3	Diodes	LL4148DICT-ND	Diode, 1N4148 SMT DL35	D1, D5, D6
17	2	International Rectifier	10BF60	Diode, SMT SMB	D2, D4
18	1	Diodes	ZMM5250BCT	Diode, Zener 20V SMT DL35	D3
19	1	Motorola	MC34262	IC, Power Factor Controller	IC1
20	1	International Rectifier	IR21571	IC, Ballast Driver	IC2
21	1	Panasonic	ELF-15N007A	EMI Inductor, 1X10mH 0.7Apk	L1
22	1	RG-Allen		PFC Inductor, 2.0mH 2.0Apk	L2
23	1	RG-Allen		Inductor, 2.0mH 2.0Apk	L3
24	3	International Rectifier	IRF830	Transistor, MOSFET	M1, M2, M3
25	5	Panasonic	ERJ-8GEYJ680K	Resistor, 680K ohm SMT 1206	R1, R2, R4, R5, R17
26	1	Panasonic	ERJ-8GEYJ10K	Resistor, 10K ohm SMT 1206	R3
27	1	Panasonic	ERJ-8GEYJ8.2K	Resistor, 8.2K ohm SMT 1206	R6
28	1	Panasonic	ERJ-8GEYJ100K	Resistor, 100K ohm SMT 1206	R7
29	3	Panasonic	ERJ-8GEYJ22K	Resistor, 22K ohm SMT 1206	R8, RSTART, RT
30	3	Panasonic	ERJ-8GEYJ22	Resistor, 22 ohm SMT 1206	R9, R13, R15
31	1	Dale	CW-1/2	Resistor, 1.0 ohm ½ watt	R10
32	1	Panasonic	ERJ-8GEYJ56K	Resistor, 56K ohm SMT 1206	R11
33	1	Yageo	2.2MQBK-ND	Resistor, 2.2megohm ¼ watt	R12
34	1	Dale	CW-1/2	Resistor, 0.68 ohm ½ watt	RCS
35	1	Panasonic	ERJ-8GEYJ5.6K	Resistor, 5.6K ohm SMT 1206	RDT
36	1	Panasonic	ERJ-8GEYJ30K	Resistor, 30K ohm SMT 1206	ROC
37	1	Panasonic	ERJ-8GEYJ75K	Resistor, 75K ohm SMT 1206	RPH
38	1	Panasonic	ERJ-8GEYJ150K	Resistor, 150K ohm SMT 1206	RRUN
39	1	Yageo	390KQBK-ND	Resistor, 390K ohm ¼ watt	R14
40	1	Panasonic	ERJ-8GEYJ1K	Resistor, 1K ohm SMT 1206	R16
41	1	Panasonic	ERJ-8GEYJ2.2M	Resistor, 2.2megohm SMT 1206	R18
42	1	Yageo	100KQBK-ND	Resistor, 100K ohm ¼ watt	R19
43	1	Panasonic	ERZ-V05D471	Transient Suppressor	RV1
44	2	Panasonic	ERJ-8GEYJ10	Resistor, 10 ohm SMT 1206	R20, R21
Total	65				

## Power Factor Correction

The power factor correction section consists of the Motorola Semiconductor MC34262 Power Factor Controller IC (IC1), MOSFET M1, inductor L2, diode D2, capacitor C8 and additional biasing, sensing and compensation components (see schematic diagram). The IC was chosen for its minimal component count, low start-up supply current and robust error amplifier. This is a boost topology designed to step-up and regulate the output DC bus voltage while drawing sinusoidal current from the line (low THD) which is "in phase" with the AC input line voltage (HPF). The design of the power factor correction section was taken from the Motorola Semiconductor MC34262 data sheet and information on the operation and design considerations for the MC34262 are contained therein.

## Ballast Control

The ballast control section is built around the IR21571 Ballast Control IC, IC2 of the Demo board. The IR21571 contains an oscillator, a high voltage half-bridge gate driver and lamp fault protection circuitry. A block diagram of the IR21571 IC is shown in figure 1 and a state diagram of the IR21571 is shown in figure 2. Following is a breakdown of the operation of the ballast in all of the different modes of operation.

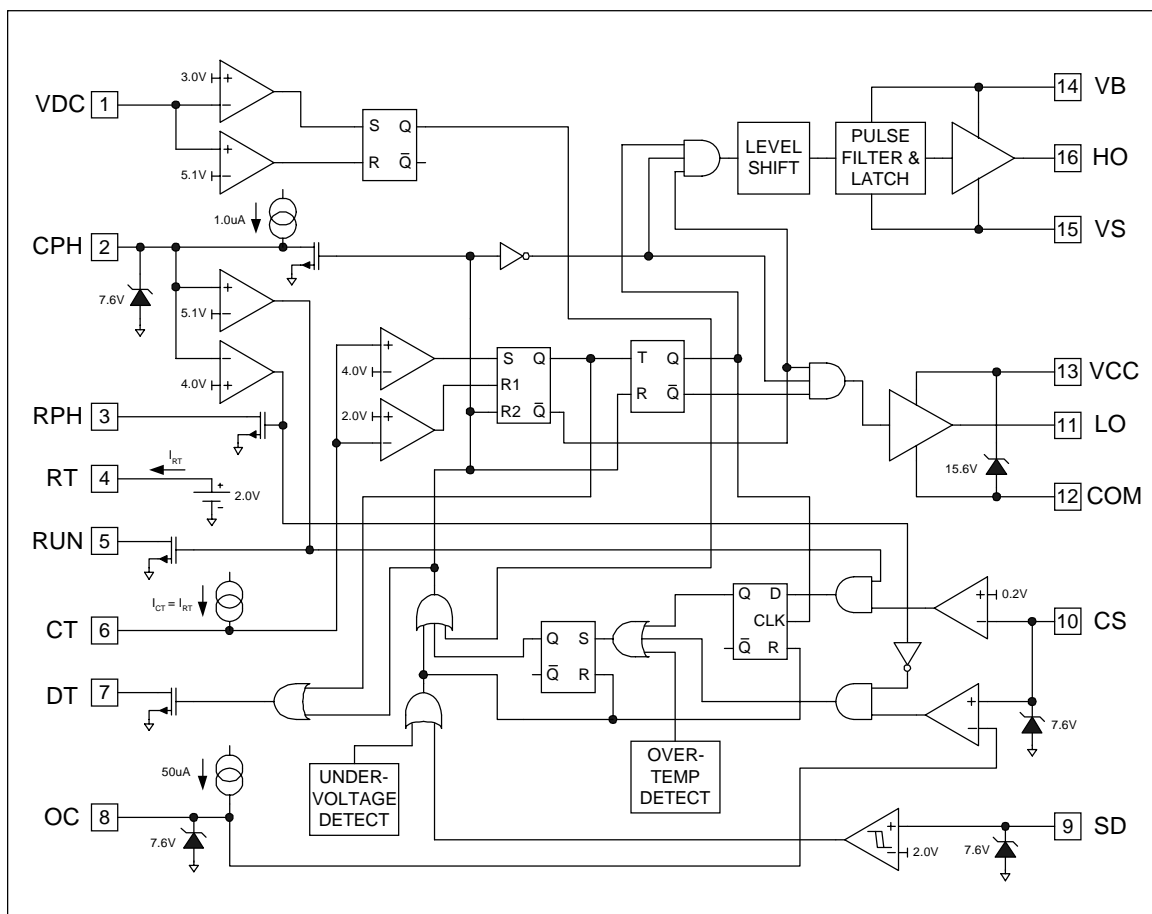

Figure 1: IR21571 Block Diagram

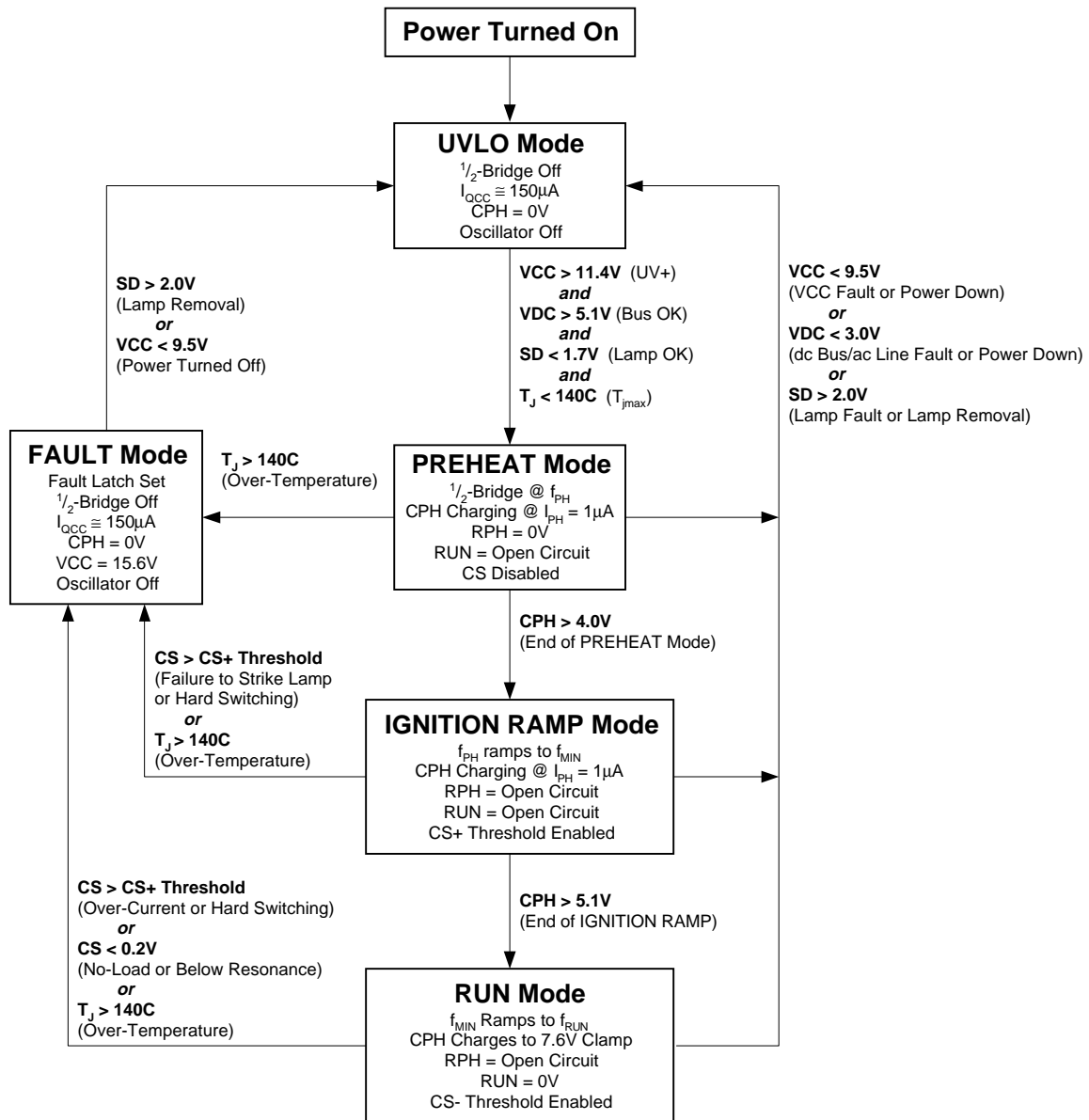
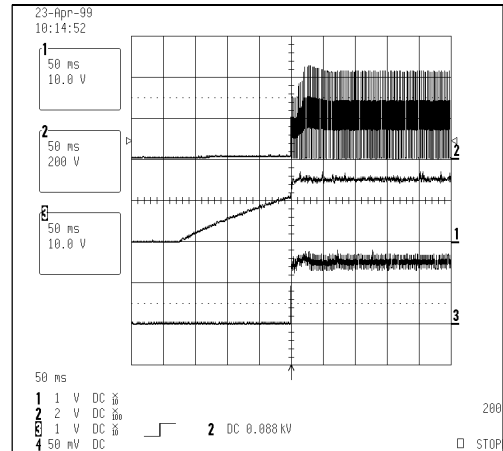

Figure 2: IR21571 State Diagram

## Startup Mode

When power is initially applied to the ballast, the voltage on the VCC pin of IC2 (IR21571) begins to charge up. The voltage for IC2 is derived from the current supplied from the rectified AC line through startup resistor R14. During this initial startup when the VCC voltage of IC2 is below its rising under-voltage lock-out threshold (11.4V), IC2 is in its UVLO and also its micro-power mode. The micro-power mode of the IC2 allows the use of a large value, low wattage startup resistor (R14). When the voltage on IC2 reaches the rising under-voltage lockout threshold, the oscillator is enabled (this assumes that there are no fault conditions) and drives the half-bridge output MOSFETs (M2 and M3). When the half-bridge is oscillating, capacitor C16, diodes D5 and D6 form a snubber /charge pump circuit which limits the rise and fall time at the half-bridge output and also supplies the current to charge capacitor C12 to the VCC clamp voltage (approx. 15.6V) of IC2. The voltage for IC1 is derived from the current supplied from another snubber/charge pump circuit formed by capacitor C14 and diodes D1 and D3. When the rising under-voltage lock-out threshold of IC1 is reached, it starts to oscillate and drive MOSFET M1 to boost and regulate the bus voltage to 400 VDC. An oscillograph of the startup of the VCC of IC1, VCC of IC2 and half-bridge output voltage are shown in Figure 3. (For a complete description of the operation of IC1, refer to the Motorola Semiconductor MC34262 data sheet.)

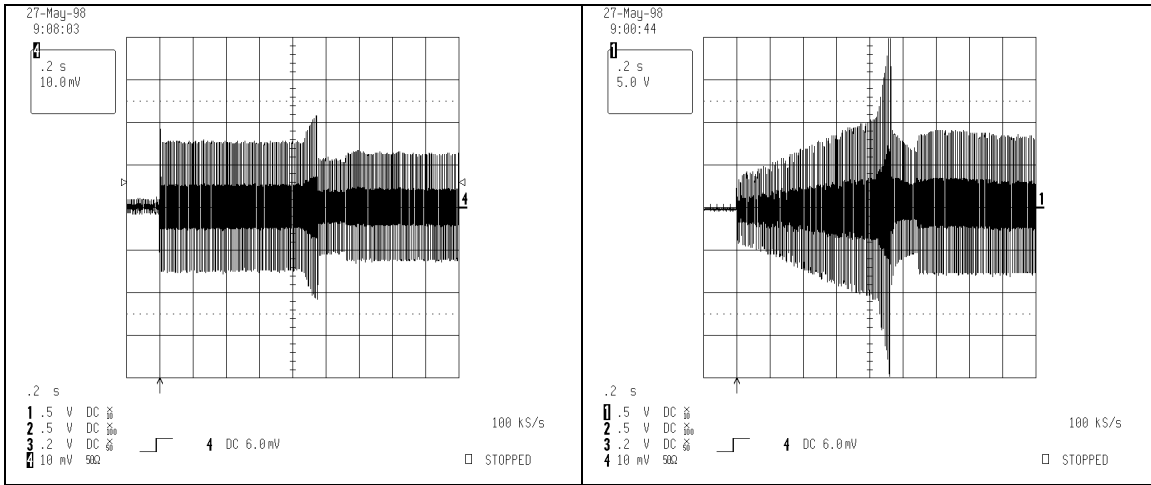

**Figure 3:** Top trace: Half-bridge output voltage  
Middle trace: VCC of IC2  
Bottom trace: VCC of IC1

## Preheat Mode

When the ballast reaches the end of the UVLO mode, the Preheat mode is entered. At this point the oscillator of IC2 has begun to operate and the half-bridge output is driving the resonant load (lamp) circuit. The oscillator section of IC2 is similar to oscillators found in many popular PWM voltage regulator ICs and consists of a timing capacitor and resistor connected to ground. Resistors RT and RPH program a current which determines the ramp up time of capacitor CT and resistor RDT determines the ramp down time. The downward ramping time of CT is the deadtime between the switching off of the LO (HO) and the switching on of the HO (LO) pins on IC2. The Preheat mode frequency of oscillation is selected such that the voltage appearing across the lamp is below the minimum lamp ignition voltage while supplying enough current to preheat the lamp filaments to the correct emission temperature within the Preheat mode period. The preheating of the lamp filaments is performed with a constant current during the Preheat mode. The waveform in Figure 4 shows the lamp filament current while Figure 5 shows lamp filament voltage during the normal Startup, Preheat, Ignition Ramp and Run modes of the ballast.

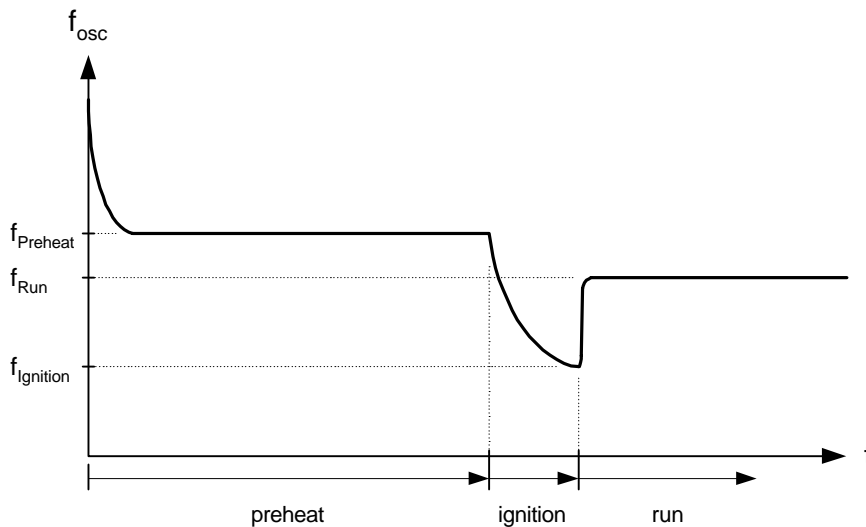



**Figure 4:** Lamp filament current during Startup, Preheat, Ignition Ramp and Run (500mA/div)

**Figure 5:** Lamp filament voltage during Startup, Preheat, Ignition Ramp and Run

Figure 6 shows a plot of the half-bridge oscillation frequency as a function of time for all of the normal modes of operation: Preheat mode, Ignition Ramp mode and Run mode. As shown in Figure 6 there is an initial startup frequency that is much higher than the steady state Preheat mode frequency that lasts for only a short duration. Components CSTART and RSTART are used to program this initial startup frequency. This is done to insure that the initial voltage appearing across the lamp at the startup of oscillation does not exceed the minimum lamp ignition voltage. If, at the initiation of oscillation of the half-bridge, the voltage across the lamp is large enough, a visible flash of the lamp occurs which should be avoided. This in effect is a cold strike of the lamp which could shorten the life of the lamp. An oscillograph of the lamp voltage at startup is shown in Figures 7 and 8 (next page). Figure 7 shows the lamp voltage without the high initial startup frequency while Figure 8 shows the lamp voltage with the high initial frequency startup.



**Figure 6:** Oscillator frequency versus time, Normal operating conditions

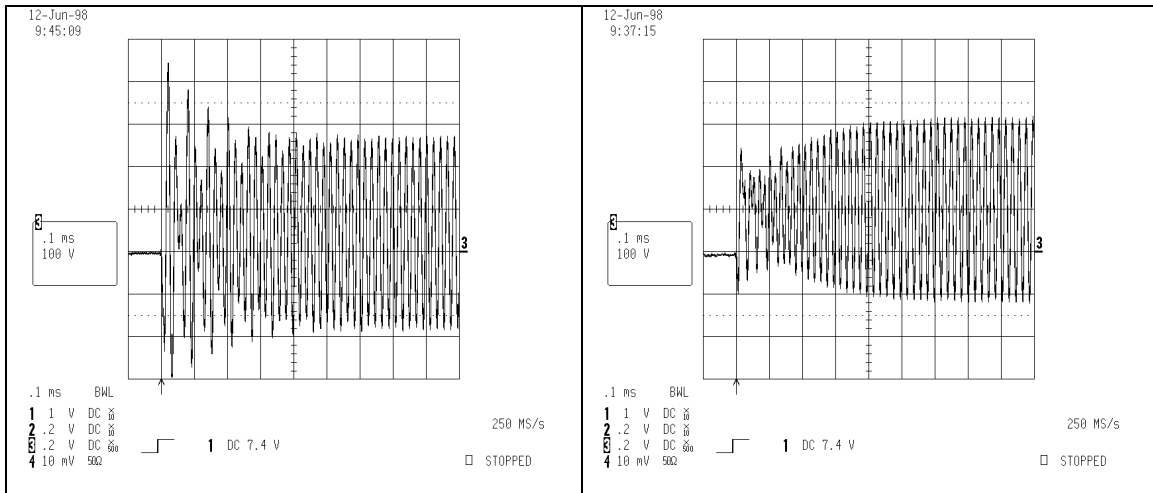

The duration of the Preheat mode as well as which mode of operation the ballast is operating in is determined by the voltage on the CPH pin of IC2. At the completion of the UVLO mode, Preheat mode is entered and an internal current source is activated at the CPH pin of IC2 which begins to charge up capacitor CPH. The ballast remains in the Preheat mode until the voltage on the CPH pin of IC2 exceeds the Ignition Ramp mode threshold (4V).

### Ignition Ramp Mode

At the completion of the Preheat mode ( $4\text{V} < \text{CPH pin} < 5.1\text{V}$ ) the ballast switches to the Ignition Ramp mode and the frequency ramps down to the ignition frequency. The frequency ramping is accomplished by turning off the internal open drain MOSFET on the RPH pin of IC2 (see Figure 1, IR21571 block diagram). Resistor RPH is no longer connected directly in parallel with resistor RT. The shift in frequency does not occur in a step function but rather with an exponential decay because of capacitor CRAMP in series with resistor RPH to ground. The duration of this frequency ramp is determined by the time constant of the RC combination of capacitor CRAMP and resistor RPH. The minimum frequency of oscillation occurs at the end of this ramp and is determined by resistor RT and capacitor CT. During this ramping downward of the frequency, the voltage across the lamp increases in magnitude as the frequency approaches the resonant frequency of the LC load circuit until the lamp ignition voltage

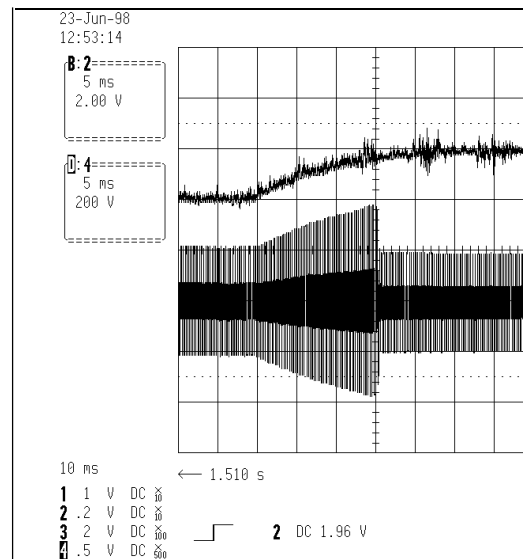

is exceeded and the lamp ignites. Figure 9 shows the ramping of voltage appearing across the lamp and also the voltage on capacitor CRAMP. Note that the sudden drop in lamp voltage indicates that the lamp has ignited. Also note that the voltage on capacitor C12 is still increasing at the point when the lamp has already ignited meaning the frequency is still ramping down to the final minimum ignition frequency. This minimum frequency corresponds to the absolute maximum ignition voltage required by the lamp under all conditions.

During the Ignition Ramp mode the voltage on the CPH pin of IC2 continues to ramp up until the voltage at the CPH pin of IC2 exceeds the Run mode threshold (5.1V). Over-current sensing is also enabled at the beginning of the Ignition Ramp mode. A full explanation of the functionality of the over-current sensing is in the section on Fault Mode.

### Run Mode

At the end of the Ignition Ramp mode (CPH pin > 5.1V) the ballast switches to the Run mode at which point the frequency is shifted to the run frequency. The run frequency is determined by the parallel combination of resistors RT and RRUN and capacitor CT. Resistor RRUN is connected in parallel by turning on the internal open drain MOSFET connected to the RUN pin of IC2 (see Figure 1, IR21571 block diagram). The sensing of under-current conditions is also enabled at the beginning of the Run mode. The full explanation of the functionality of the under-current sensing is in the section on Fault Mode. Figure 10 shows the functionality of the CPH, RPH and RUN pins of IC2 during Startup, Pre-heat, Ignition Ramp and Run modes.

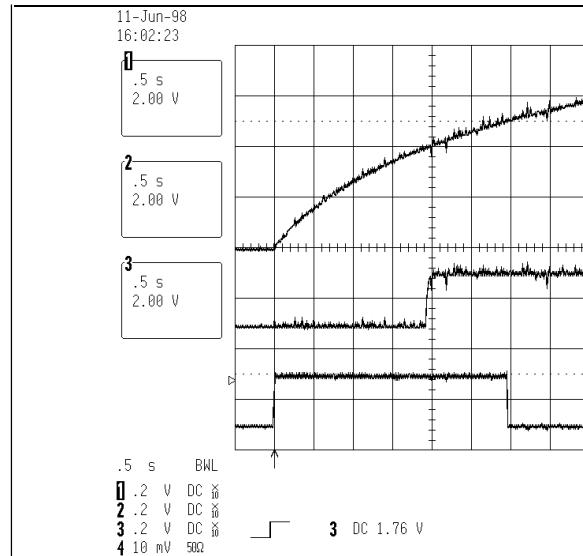

**Figure 10:** Top trace: CPH pin IC2  
Middle trace: RPH pine IC2  
Bottom trace: RUN pin IC2

The Run mode frequency is that at which the lamp is driven to the lamp manufacturer's recommended lamp power rating. The running frequency of the lamp resonant output stage for selected component values is defined as,

$$f_{run} = \frac{1}{2\pi} \sqrt{\frac{1}{LC} - 2\left(\frac{P_{Lamp}}{CV^2_{Lamp}}\right)^2} + \sqrt{\left[\frac{1}{LC} - 2\left(\frac{P_{Lamp}}{CV^2_{Lamp}}\right)^2\right]^2 - 4\frac{1 - \left(\frac{2V_{DCbus}}{V_{Lamp}\pi}\right)^2}{L^2C^2}} \quad (3)$$

where,

$L$	= Lamp resonant circuit inductor (L3)	(H)
$C$	= Lamp resonant circuit capacitor (C14)	(F)
$P_{Lamp}$	= Lamp running power	(W)
$V_{Lamp}$	= Lamp running voltage amplitude	(V)

Figure 11 shows the voltage appearing across the lamp while Figure 12 shows the current flowing through the lamp during Startup, Preheat, Ignition Ramp and Run modes.

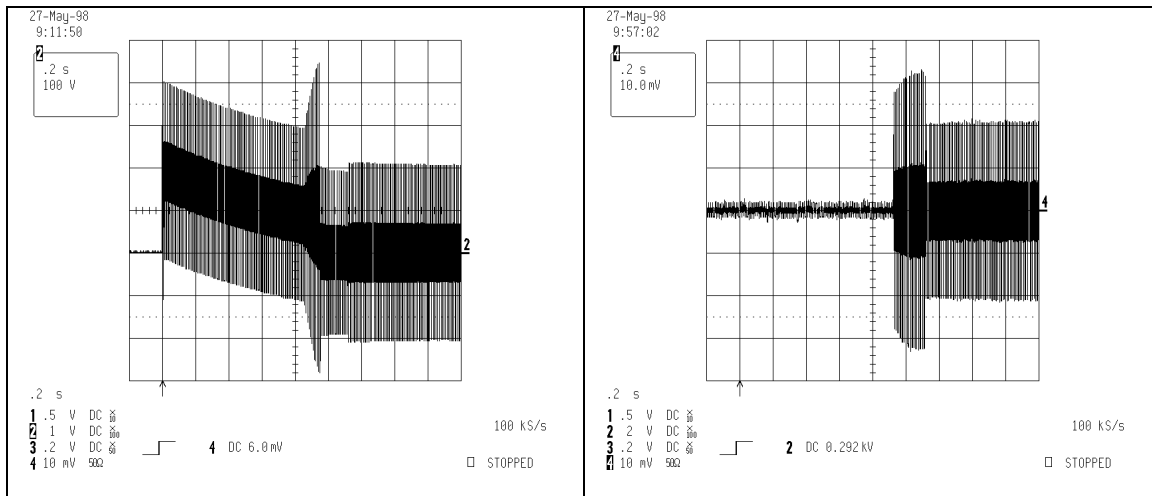

Figure 11: Lamp voltage during Startup, Preheat, Ignition Ramp and Run

Figure 12: Lamp current during Startup, Preheat, Ignition Ramp and Run (100mA/div.)

## Normal Powerdown

A Normal Powerdown occurs when the AC line voltage is disconnected from the ballast. When this occurs the voltage on the VDC pin of IC2 drops below the line fault threshold (3V) and IC2 shuts down in a controlled fashion. The oscillator is stopped, the half-bridge driver outputs (LO and HO) are turned off and capacitors CPH, CRAMP, CSTART and CT are discharged. IC2 also goes into its UVLO/micro-power mode and the bus voltage begins to collapse.

## Fault Mode

Fault mode is when the ballast driver is shutdown due to the detection of a lamp fault. Note that when the ballast is in this Fault mode the power factor correction section of the ballast is also shutdown and the bus voltage will drop to the non-boosted/unregulated level. There are several lamp fault conditions which can put the ballast into the Fault mode. The lamp fault conditions detected include: near/below resonance (under-current) detection, hard-switching detection and over-current detection. Resistor RCS in the source lead of the low side MOSFET (M3) serves as the current sensing point for the half-bridge which is used to detect these lamp fault conditions. In operation when the half-bridge is oscillating, a voltage appears across RCS whenever the low side MOSFET, M3, is

turned on or the high side MOSFET, M2, is turned off. The magnitude of this voltage directly relates to the current in the lamp resonant circuit. Figure 13 shows the voltage which appears across resistor RCS during normal Run mode conditions while Figure 14 shows the voltage appearing across the lamp during the end of Preheat mode, Ignition Ramp mode and the beginning of Run mode. Also shown in Figure 13 are the gate drive signals for the low side MOSFET (LO pin) and the high side MOSFET (HO-VS pin).

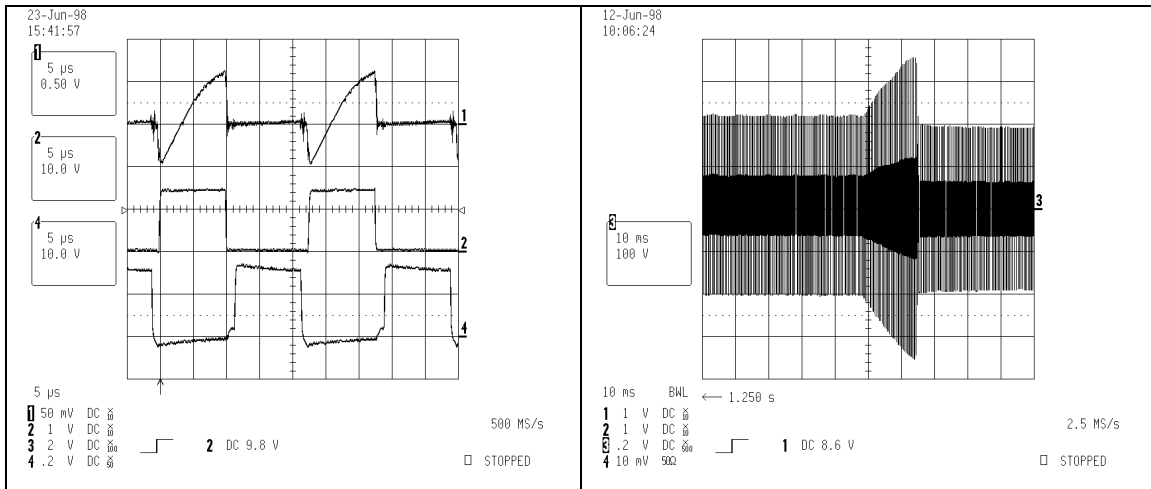

Figure 13: Normal Run mode, Upper trace: voltage across RCS, Middle trace: IC2 LO pin voltage, Lower trace: IC2 HO-VS pin voltage

Figure 14: Normal lamp ignition: Lamp voltage during the end of Preheat mode, Ignition Ramp mode and the beginning of the Run mode

During the Preheat mode the voltage across resistor RCS is not measured. However, at the end of Preheat mode (the beginning of the Ignition Ramp mode) the hard-switching and over-current detection are enabled. If at any time thereafter the voltage magnitude across resistor RCS rises above the over-current (CS+) threshold of the CS pin of IC2, a lamp fault condition is signaled and the half-bridge output MOSFETs', (M2 and M3) are turned off and the ballast goes into Fault mode. This can happen if the lamp fails to ignite or if the upper filament is open. For failure to ignite the lamp, the current in the half-bridge increases and thus the voltage across resistor RCS increases above the over-current threshold signaling a fault. Figure 15 shows the voltage across resistor RCS and the voltage appearing across the lamp when the ballast detects a failure to ignite the lamp and goes into Fault mode. The CS+ threshold is determined by resistor ROC. An internal current source of 50uA is connected to the OC pin of IC2 which when applied to resistor ROC sets a voltage at the OC pin. This voltage is the CS+ threshold of IC2. Figure 16 shows the voltage appearing across the lamp during the tail end of the Preheat mode and the Ignition Ramp mode for a failure of the lamp to ignite condition. If the upper filament is open, the half-bridge output hard-switches and each time the low side MOSFET (M3) is turned on a large current pulse occurs and thus a large voltage pulse occurs across resistor RCS signaling a fault, Figure 17 shows this hard-switching condition. Figure 18 shows the lamp voltage during the Preheat mode and beginning of Ignition Ramp mode for this hard-switching condition when the lamp fault condition is detected. The ballast will remain in Fault mode until either the line voltage is cycled or a lamp replacement is performed.

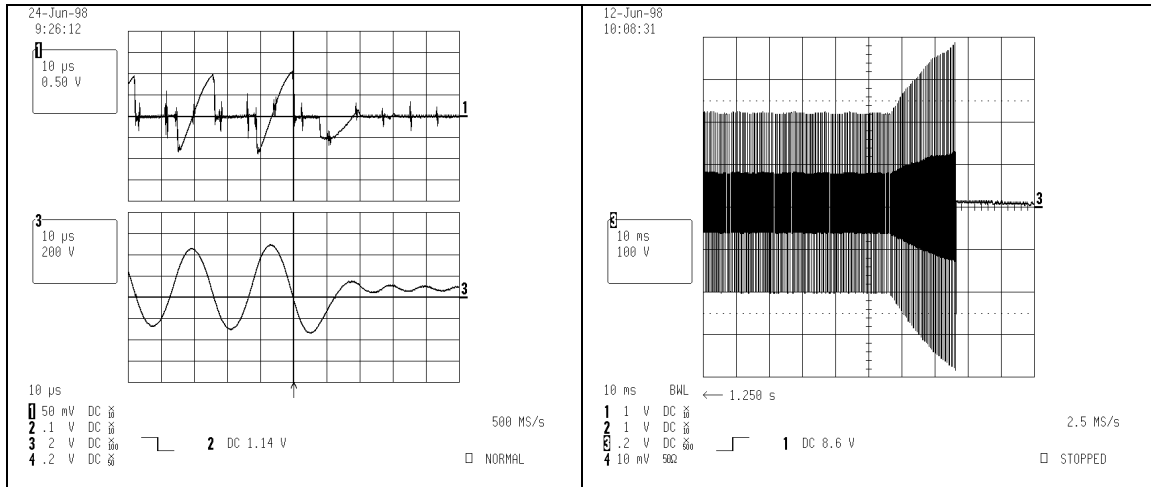

Figure 15: Failure of lamp to ignite condition (lamp filaments good): Upper trace: voltage across RCS, Lower trace: lamp voltage

Figure 16: Failure of lamp to ignite condition (lamp filaments good): Lamp voltage during the end of Preheat and Ignition Ramp modes

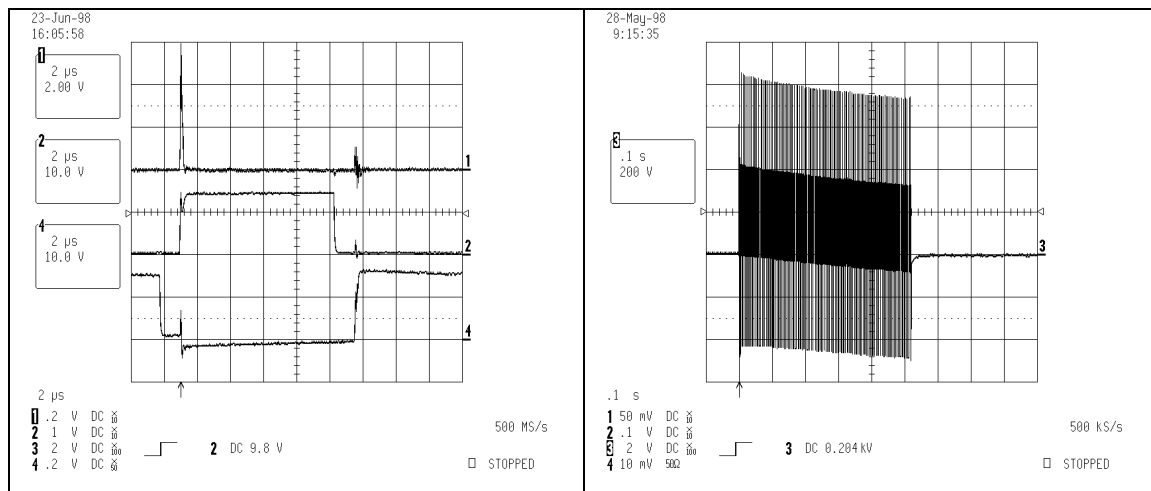

Figure 17: Hard-switching condition (upper filament open): Upper trace: voltage across RCS, Middle trace: IC2 LO pin voltage, Lower trace: IC2 HO-VS pin voltage

Figure 18: Hard-switching condition (upper filament open): Lamp voltage during Preheat mode and beginning of Ignition Ramp mode when lamp fault is detected

At the completion of the Ignition Ramp mode (beginning of the Run mode) the near/below resonance (under-current) detection is also enabled. Near/below resonance detection is performed by synchronously sensing the voltage across resistor RCS, which relates to the current flowing in the low side MOSFET (M3), just prior to the turn off of M3. If this voltage is lower than the near/below resonance threshold (CS- = 0.2V) of the CS pin of IC2, a lamp fault condition is signaled and the ballast goes into Fault mode. This could occur if the frequency of oscillation becomes too close to the resonant

frequency of the load circuit and the current in the load circuit commutates to close to zero. Figure 19 shows a near/below resonance condition where the voltage on resistor RCS falls below the 0.2V threshold on the CS pin of IC2.

Resistors R17, R18 and capacitor C13 form a divider/filter network which is used to detect an open lower lamp filament and/or lamp replacement. Under normal conditions, the voltage across C8 is approximately zero volts. However, if the lower filament becomes open or the lamp is removed, the voltage across C13 increases above the 2V threshold for the SD pin of IC2 and signals a lamp fault condition which in turn puts the ballast into Fault mode. The ballast remains in the Fault mode until the line voltage is cycled or a lamp replacement is performed. If the lamp is replaced with a lamp with a good lower filament, the voltage on the SD pin of IC2 is pulled back below the 2V threshold and the ballast will go through a restart. Line voltage cycling is also used to restart the ballast for all lamp fault conditions. The ballast will go through a full Preheat, Ignition Ramp and Run modes any time a restart is performed. Note that the SD pin of IC2 is active during all modes of operation.

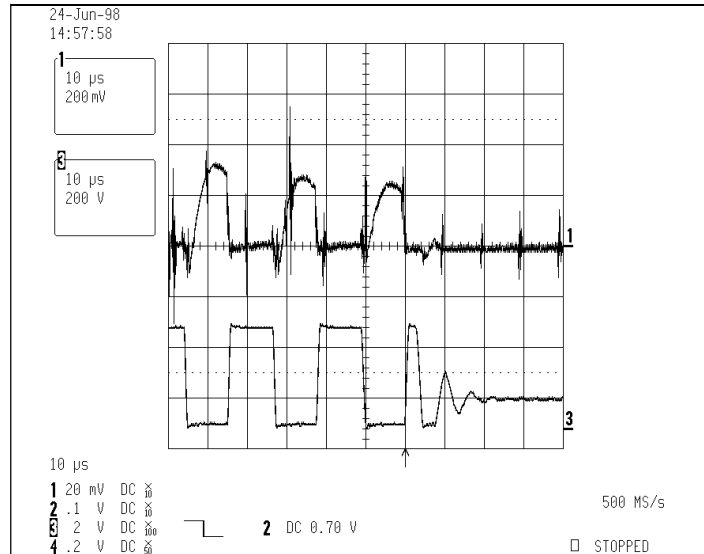

Figure 19: Near/Below Resonance conditions  
Upper trace: voltage across RCS  
Lower trace: half-bridge output voltage

Another way that the ballast can go into Fault mode is if the AC line voltage falls below approximately 170Vrms. Resistors R11, R12 and capacitor C9 form a voltage divider/filter network which is connected to the VDC pin of IC2 and is used to determine if the line voltage falls below permissible levels. This happens when the line voltage is cycled or possibly a brownout condition occurs. The VDC pin of IC2 senses a fault if the voltage at the pin falls below 3 volts and shutdown of the ballast occurs. The ballast remains shutdown until the voltage at the VDC pin rises above 5.1 volts. At this time if there are no other fault conditions the ballast will go through a full Preheat, Ignition Ramp and Run mode. As in the case of the SD pin of IC2, the VDC pin of IC2 is active during all modes of operation of the ballast.

International  
**IR** Rectifier

IR WORLD HEADQUARTERS: 233 Kansas St., El Segundo, California 90245 Tel: (310) 252-7105  
Data and specifications subject to change without notice. 10/28/2000

