

## Multifunction Digital Timer

## H5BR

Easy-to-Use Timer with Batch Counting  
in 72 x 72 mm DIN Size Unit

- Nine field-selectable output modes accommodate a wide variety of applications
- All parameters set by scroll-through menus accessed from the front panel
- Field-selectable time ranges from 0.001 second to 9999 hours
- High-visibility alphanumeric LCD display has 12 mm high characters and built-in backlight
- Batch counting function records the number of completed cycles
- Contact and solid-state outputs available simultaneously
- Precision control possible to 0.001 second
- Four levels of key protection provided
- Selectable elapsed time (UP) and time remaining (DOWN) display



## Ordering Information

### ■ TIMERS

|                  |   |                                   |
|------------------|---|-----------------------------------|
| Timing functions | 9 selectable, including ON-delay, repeat cycle, OFF-delay, and one-shot |                                   |
| Contact type     | One SPDT relay and two NPN open collector transistor outputs            |                                   |
| Terminal form    | 16 terminal screws on rear of case                                      |                                   |
| Supply voltage   | 100 to 240 VAC, 50/60 Hz  | 24 VAC, 50/60 Hz and 12 to 24 VDC |
| Part number      | H5BR-B-AC100-240  | H5BR-B-AC24/DC12-24               |

### ■ ACCESSORIES

| Description   | Part number |
|---|-------------|
| Soft cover with two mounting clips for front panel protection | Y92A-72F1   |
| Shock prevention terminal cover protects wiring connections   | Y92A-72T    |
| NEMA 4 waterproof cover                                       | Y92A-72N    |

■ RANGE AND OPERATION MODE SELECTION

| Range selection | Time unit    | Maximum setting       |
|-----------------|--------------|-----------------------|
| - . - - - s     | 0.001 second | 9.999 seconds         |
| - . . - - s     | 0.01 second  | 99.99 seconds         |
| - - . - - s     | 0.1 second   | 999.9 seconds         |
| - - - - s       | 1 second     | 9999 seconds          |
| - - min - - s   | 1 second     | 99 minutes 59 seconds |
| - - . - min     | 0.1 minute   | 999.9 minutes         |
| - - - - min     | 1 minute     | 9999 minutes          |
| - - hr - - min  | 1 minute     | 99 hours 59 minutes   |
| - - . - hr      | 0.1 hour     | 999.9 hours           |
| - - - - hr      | 1 hour       | 9999 hours            |

| Mode | Operation                           | Output type            |
|------|-------------------------------------|------------------------|
| A    | ON-delay                            | Sustained or one-shot* |
| A-1  | Sustained start signal ON-delay     |                        |
| A-2  | Power ON-delay                      |                        |
| A-3  | Power ON-delay/non-power resettable |                        |
| B    | Repeat cycle                        | Sustained              |
| B-1  | Repeat cycle/non-power resettable   |                        |
| D    | OFF-delay                           |                        |
| E    | One-shot                            |                        |
| F    | Cumulative signal ON-delay          |                        |

\*One-shot output can be set from 0.1 to 99.9 s.

Specifications

| Part number       |  | H5BR-B-AC100-240  | H5BR-B-AC24/DC12-24   |  |
|-------------------|--|---|---|--|
| Supply voltage    |  | 100 to 240 VAC, 50/60 Hz  | 24 VAC, 50/60 Hz and 12 to 24 VDC (permissible ripple: 20% max.)                      |  |
| Operating voltage |  | 85% to 110% of rated voltage  |   |  |
| Power consumption | AC                                     | Approximately 8 VA at 50 Hz, 240 VAC  |   |  |
|                   | DC                                     | Approximately 5 W at 24 VDC   |   |  |
| Inputs            | Types available                        |   | Start, reset, gate, batch count reset, and key protect                                |  |
|                   | Signal, reset, gate, batch count reset | Type  | No-voltage input  |  |
|                   |  | ON impedance  | 1 kΩ max. (Approx. 2 mA when 0Ω)  |  |
|                   |  | Residual voltage  | 2 V max. in ON state  |  |
|                   |  | OFF impedance   | 100 kΩ minimum  |  |
|                   |  | Pulse width   | 1 ms or 20 ms selectable for reset and signal<br>20 ms for gate and batch count reset |  |
|                   | Key protect                            | Type  | No-voltage input  |  |
|                   |  | ON impedance  | 1 kΩ max. (Approx. 2 mA when 0Ω)  |  |
|                   |  | Residual voltage  | 1 V max. in ON state  |  |
|                   |  | OFF impedance   | 100 kΩ minimum  |  |
| Response time     |  | 1 second  |   |  |
| Control output    | Type                                   | Time limit  | SPDT relay output or NPN open collector transistor output                             |  |
|                   |  | Instantaneous   | —   |  |
|                   | Relay                                  | Max. load   | 5 A, 250 VAC resistive load (p.f. = 1)  |  |
|                   |  | Min. load   | 10 mA, 5 VDC  |  |
|                   | Solid-state                            | Max. load   | 100 mA, 30 VDC  |  |
| Residual voltage  |  | 2 V max., 1 V typical   |   |  |
| Batch output      |  | Transistor output (NPN open collector)  |   |  |
| Repeat accuracy   | Power start                            | ±0.01%, ±0.05 second max.   |   |  |
|                   | Signal start                           | ±0.005%, ±0.03 second max. (rate for set value)   |   |  |
| Setting error     |  | —   |   |  |
| Resetting system  |  | Power reset (A, A-1, A-2, B, D and E modes)<br>External, manual, automatic resets (may be internal depending on A-1, B, B-1, D and E operation modes) |   |  |
| Resetting time    | Power reset                            | 0.5 second minimum (A, A-1, A-2, B, D and E modes)  |   |  |
| Indicators        |  | 4-digit LCD alphanumeric display with backlighting<br>12 mm (0.47 in) H present value, 8 mm (0.31 in) H set value                                     |   |  |
| Memory function   |  | Retains preset values for 10 years at 20° C (68° F)   |   |  |
| Materials         |  | Plastic case  |   |  |
| Mounting          |  | Panel   |   |  |
| Connections       |  | Screw terminals   |   |  |
| Weight            |  | 270 g (9.6 oz)  |   |  |

## SPECIFICATIONS continued

|                                     |                        |   |
|-------------------------------------|------------------------|---|
| Approvals                           |                        | UL/ CSA/SEV/CE (EMC)  |
| Operating ambient temperature       |                        | -10° to 55°C (14° to 131°F) with no icing   |
| Humidity                            |                        | 35% to 85% RH   |
| Vibration                           | Mechanical durability  | 10 to 55 Hz with 0.75 mm (0.03 in) single amplitude in 3 directions   |
|                                     | Malfunction durability | 10 to 55 Hz with 0.5 mm (0.02 in) single amplitude in 3 directions  |
| Shock                               | Mechanical durability  | 30 G each in three directions   |
|                                     | Malfunction durability | 10 G each in three directions   |
| Variation due to voltage change     |                        | Included in "Repeat accuracy" specification   |
| Variation due to temperature change |                        | Included in "Repeat accuracy" specification   |
| Insulation resistance               |                        | 100 MΩ min. at 500 VDC between current-carrying terminal and exposed non-current-carrying metal parts, and between non-continuous contacts.   |
| Dielectric strength                 |                        | 2,000 VAC, 50/60 Hz for 1 minute between current-carrying terminal and exposed non-current-carrying metal parts for 100 to 240 VAC type<br>1,000 VAC for both 24 VAC and 12 to 24 VDC types |
| Service life<br>(SPDT relay)        | Mechanical             | 10 million operations minimum   |
|                                     | Electrical             | 100,000 operations minimum at 5 A, 240 VAC, resistive load (p.f. = 1)   |

## Timing Charts

## ■ OPERATION MODES

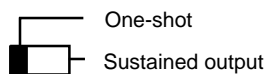
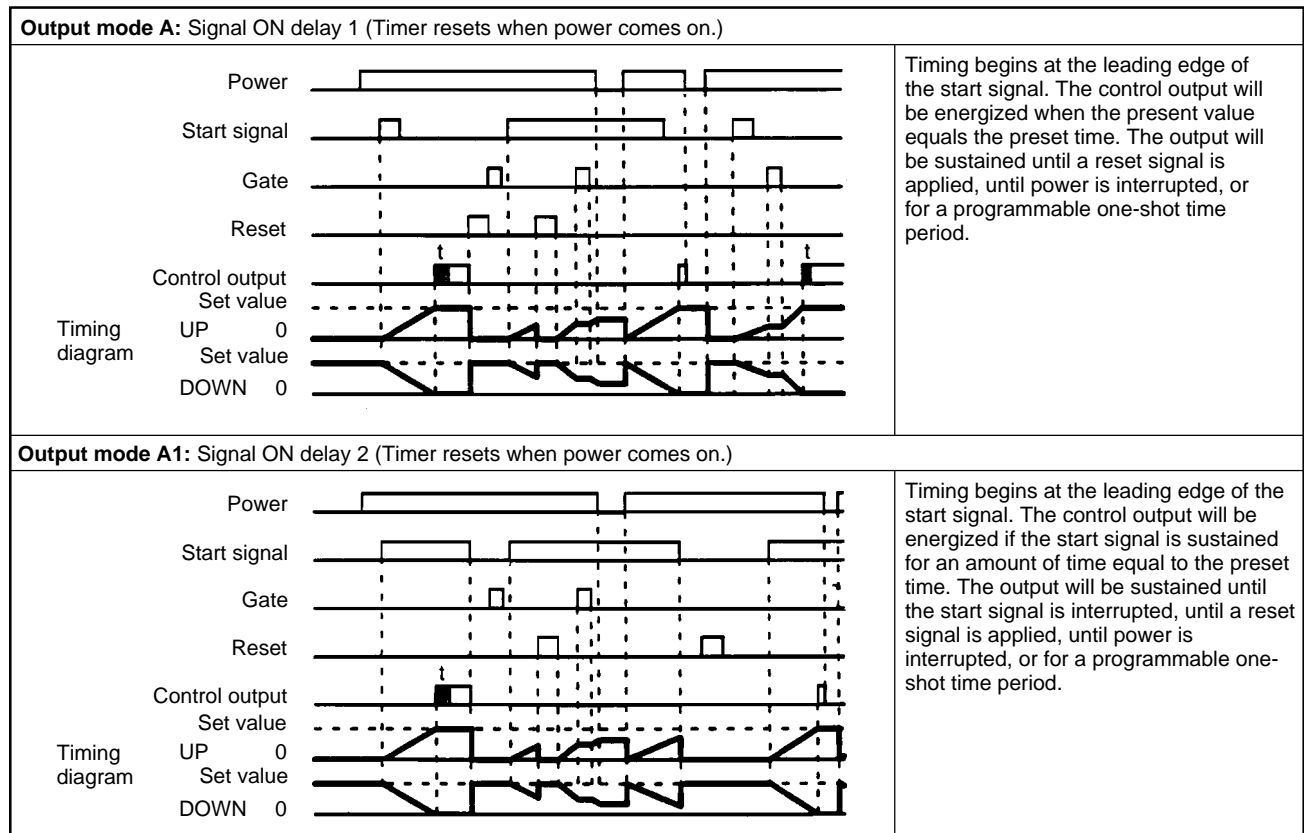

One-shot output can be set from 0.1 s to 99.9 s.

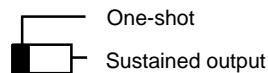
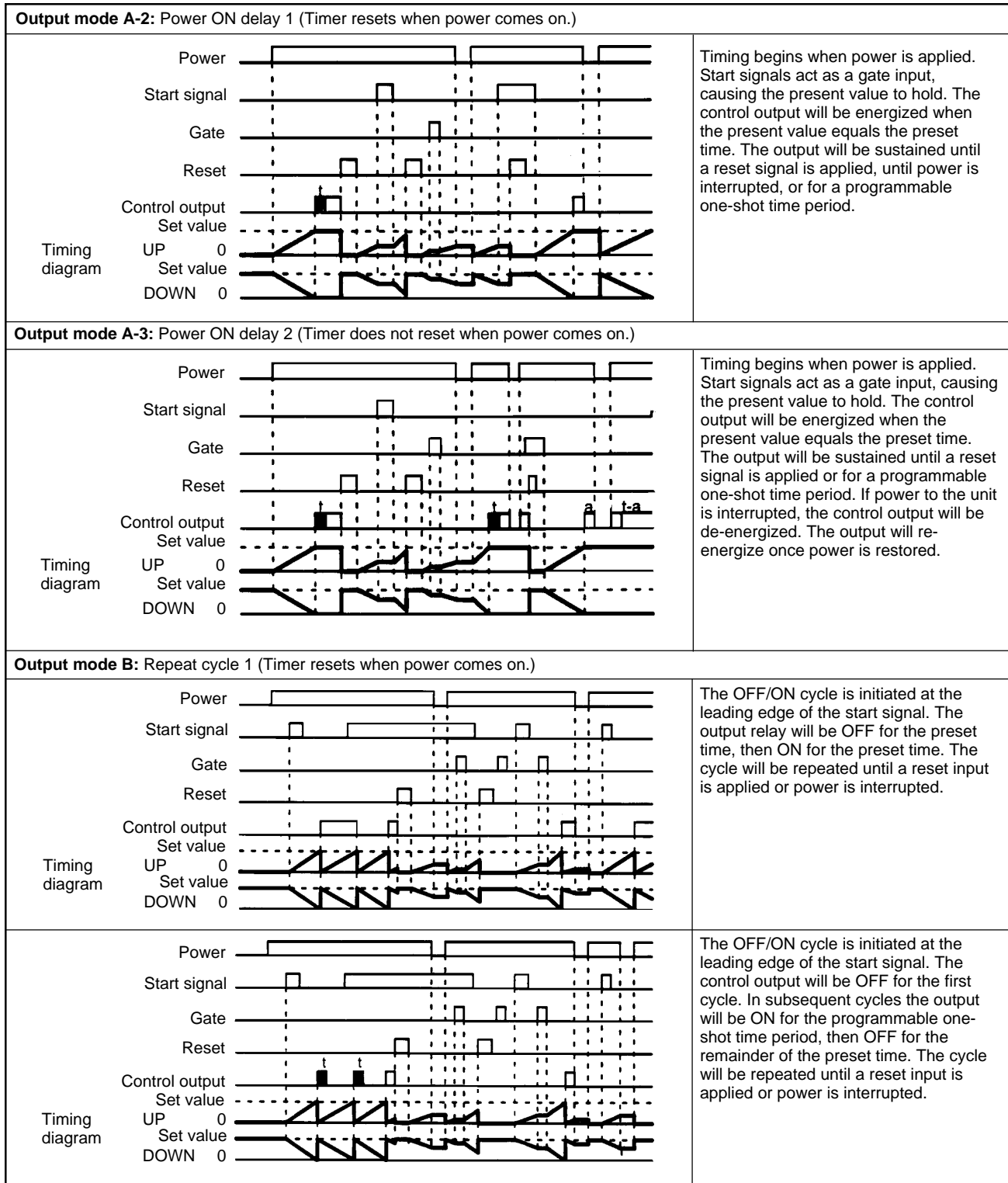

One-shot output can be set from 0.1 s to 99.9 s.  
 a = one-shot time before power interruption  
 t-a = remaining one-shot time after power interruption

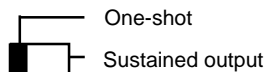
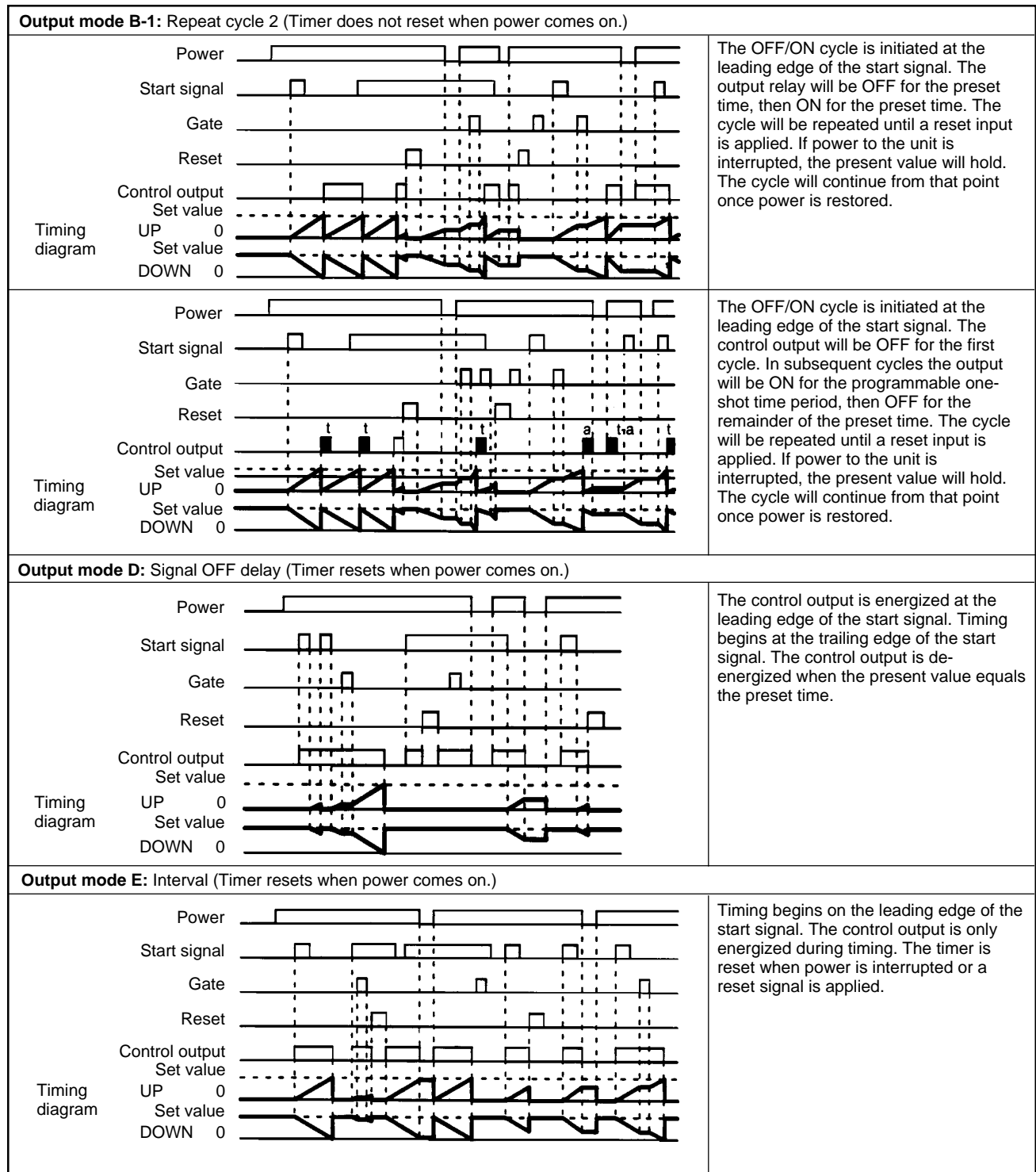

One-shot output can be set from 0.1 s to 99.9 s.

a = one-shot time before power interruption

t-a = remaining one-shot time after power interruption

**Output mode F: Cumulative (Timer does not reset when power comes on.)**

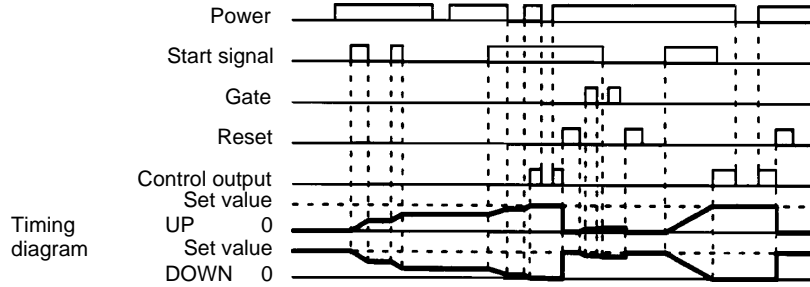

Timing begins on the leading edge of the start signal. The control output is energized when the cumulative elapsed time of the start signal is equal to the preset time. The output is sustained until power is interrupted or a reset signal is applied.

**BATCH COUNTER OPERATION**

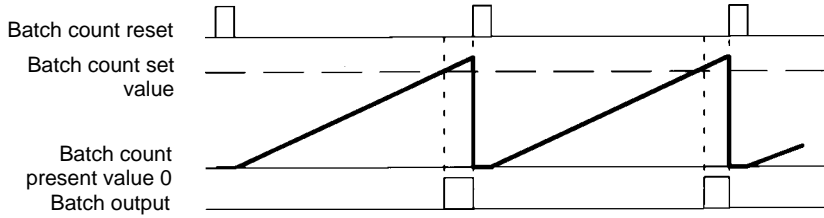

The batch count output holds until reset by the batch count reset. The present value of the batch count advances continuously.

1. The batch count present value remains at 0 while the batch count reset is ON.
2. When the batch count set value is 0, the batch count will proceed, but there will be no output.
3. When the batch count present value exceeds 9999, it returns to 0.
4. The batch count present value and output are not affected by the RESET key or reset input.
5. When power is interrupted and the batch count output is ON, the output will be ON when power returns.
6. When a batch count set value greater than the present value is changed to a set value less than the present value, the output will go ON.
7. If, after the output has gone ON, the set value is changed to a set value that is greater than the present value, the output will remain ON.
8. When utilizing latching outputs in the repeat cycle modes (B and B1), the number of completed timing is double the number of outputs. To control the number of outputs, set the batch count set value at double the desired number of outputs.

**Dimensions**

Unit: mm (inch)

**TIMER**

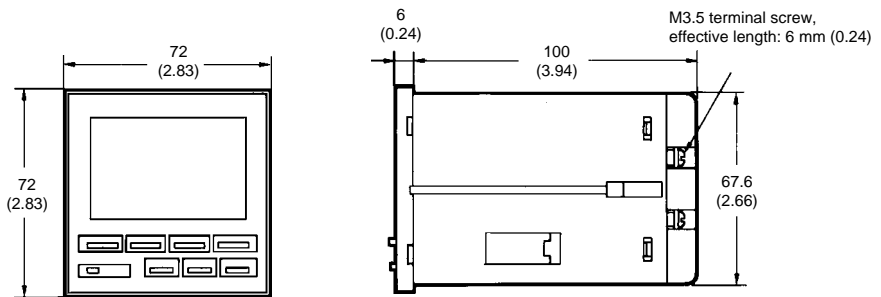
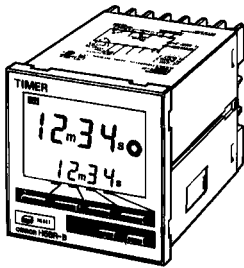

■ PANEL MOUNTING H5BR TIMERS

A pair of panel mounting adapters is included with the timer. The adapters are installed in the slots on the right and left sides of the case, as shown below.

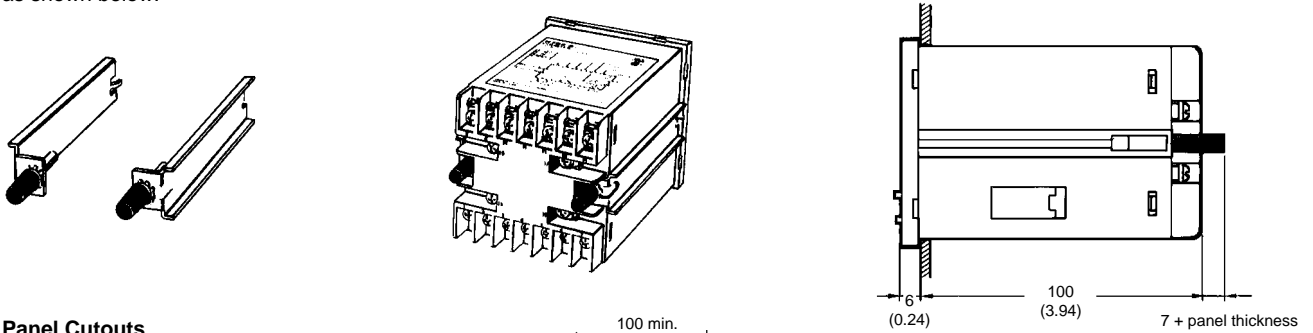

Panel Cutouts

Panel cutouts shown at right conform to DIN 43700.

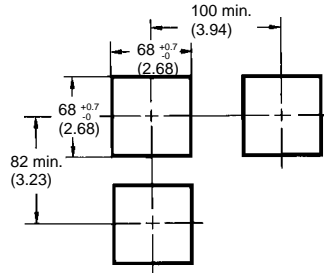

■ ACCESSORIES

Y92A-72F1 Soft plastic cover

Two mounting clips help the soft plastic cover Y92A-72F1 fit snugly over the front of the timer to protect against dirt and water. Timer settings can be changed when the cover is on. The cover is intended for use in areas where unusual service conditions do not exist.

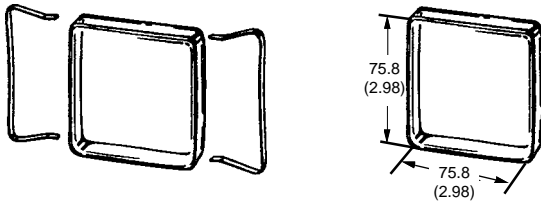

Y92A-72T Terminal cover

The terminal cover protects wiring connections.

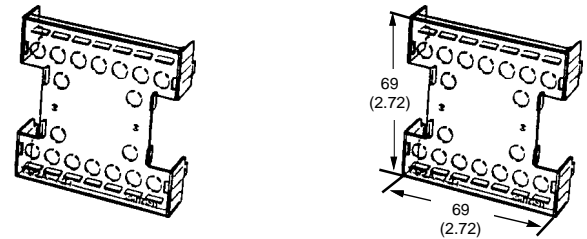

Connections

■ TERMINAL ARRANGEMENT

H5BR-B

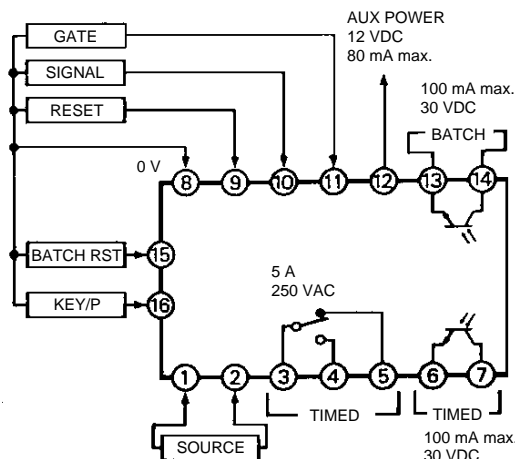

■ INPUTS

The inputs of the H5BR are no-voltage (short circuit or open) inputs.

**No-contact Input (NPN Transistor)**

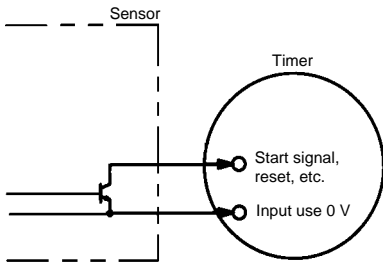

High: transistor ON

**Contact Input**

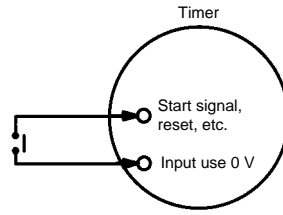

High: contact ON

**No-contact Input**

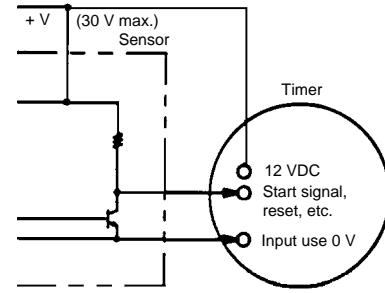

High: transistor ON

**No-voltage Input Signal Levels**

|                  |   |
|------------------|---|
| No-contact input | 1. High level<br>Transistor ON<br>Residual voltage: 2 V max.<br>Impedance when ON:<br>1 kΩ max. |
|                  | 2. Low level<br>Transistor OFF<br>Impedance when OFF:<br>100 kΩ min.                            |
| Contact input    | Use contacts which can adequately switch 2 mA at 5 V.   |

**Terminal Numbers on Power Supply for External Equipment**

|                |     |     |
|----------------|-----|-----|
| Voltage supply | DC- | DC+ |
| 12 VDC, 80 mA  | 8   | 12  |

| Input terminal numbers (no voltage) |       |      |             |             |     | Power supply terminals |               | Output terminal numbers |    |             |     |      |       |      |
|-------------------------------------|-------|------|-------------|-------------|-----|------------------------|---------------|-------------------------|----|-------------|-----|------|-------|------|
| Reset                               | Start | Gate | Batch reset | Key protect | COM | AC (common), DC-       | AC (hot), DC+ | Contact                 |    | Solid-state |     |      |       |      |
|                                     |       |      |             |             |     |                        |               | COM                     | NO | Timed       |     |      | Batch |      |
|                                     |       |      |             |             |     |                        |               |                         |    | NC          | COM | Load | COM   | Load |
| 9                                   | 10    | 11   | 15          | 16          | 8   | 1                      | 2             | 3                       | 4  | 5           | 6   | 7    | 13    | 14   |

Operation

■ NOMENCLATURE

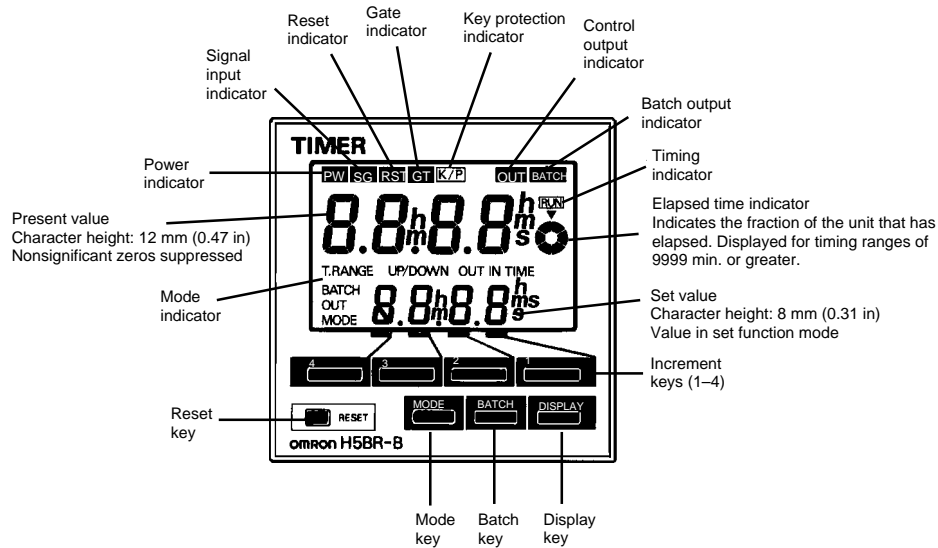



## ■ KEY OPERATIONS

| Key name             | Operation   |
|----------------------|---|
| Increment keys (1-4) | Used to change the corresponding digit of the set value. Used to change data in the set mode. |
| Display key          | Switches to the present value display.  |
| Batch key            | Switches to the batch display.  |
| Mode key             | Switches from run mode to set mode. Changes items in the set mode.                            |
| Reset key            | Resets timing and outputs.  |

## ■ FACTORY SETTINGS

The following table shows the timer settings when it is shipped. Change the settings as necessary to suit the system before operation. Settings and the display receive power from the internal battery and are, therefore, unaffected by external power interruptions. With the initial settings, there will be no output even if the power supply is connected. External inputs and outputs cannot be used without a power supply.

|                     |                        |
|---------------------|------------------------|
| Model               | H5BR-B (Standard)      |
| Time range          | - - - -s               |
| Present value       | 0.00 s                 |
| Presets             | 0.00 s                 |
| Batch present count | 0                      |
| Batch preset        | 0                      |
| UP/DOWN mode        | UP                     |
| Output mode         | A: Signal ON-delay (1) |
| Output time         | Hold                   |
| Input signal time   | 20 ms                  |
| Key protect level   | KP-1                   |

## ■ INPUT/OUTPUT FUNCTIONS

|         |                      |   |
|---------|----------------------|---|
| Inputs  | Start signal         | Stops timing in A-2 and A-3 (power ON-delay) modes. Starts timing in other modes.   |
|         | Reset                | Resets present value (to zero in UP mode, to preset in DOWN mode).<br>Control inputs are not accepted while reset input is ON.<br>Reset indicator lit while reset input is ON.  |
|         | Gate                 | Inhibits timer operation.   |
|         | Batch count reset    | Resets batch count to zero and batch output turns OFF on leading edge.<br>Batch count signals are not accepted while batch count reset is ON.   |
|         | Key protect          | Makes keys inoperative according to key protect level; four levels available.<br>Key protected indicator lit while key protect input is ON.<br>Effective when protect terminals are shorted.<br>Effective if power supply is turned off.  |
| Outputs | Control output (OUT) | Outputs made according to designated output mode when corresponding preset is reached.  |
|         | Batch output         | Outputs made when batch count equals the preset number of batches.<br>Batch output remains ON until batch count reset goes ON.<br>When the number of batches is set to zero, batch counting is performed, but batch outputs are not made. |

## ■ BATCH COUNTER APPLICATION

### Counting the Number of Bottles Filled

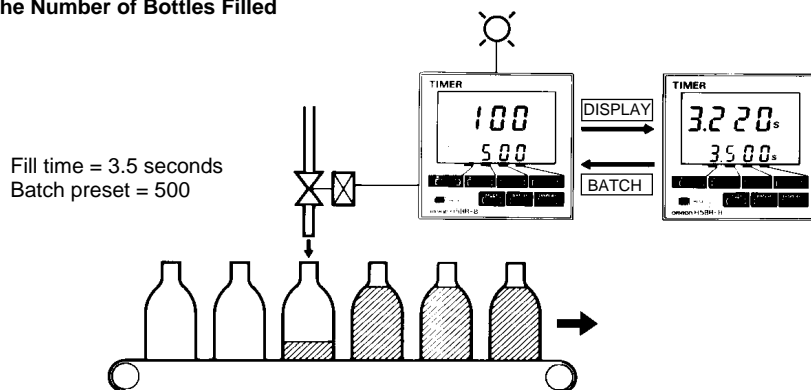

OPERATIONAL OVERVIEW

Refer to the Setting Item Table below for details on the operation of specific modes.

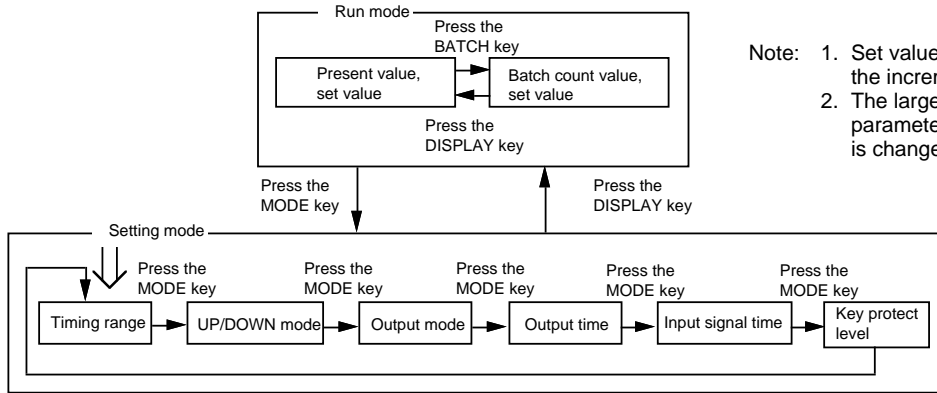

- Note:
1. Set values are changed using the increment keys (1 to 4).
  2. The large arrow indicates the parameter displayed first when the mode is changed with the MODE or DISPLAY key.

SETTING ITEM TABLE

| Mode         | Setting item          | Description  | Setting procedure   |
|--------------|-----------------------|--|---|
| Run mode     | Set value             | Compared to the present value. Determines the timing of the control output according to the output mode.   | Sequence when changing a digit using the increment keys (1 to 4).<br>   |
|              | Batch count set value | Turns ON the batch output when the preset number of cycles have been completed.  | Sequence when changing a digit using the increment keys (1 to 4).<br>   |
| Setting mode | Time range            | Determines the timing range.   | Change the timing range with the increment keys (1 to 4).   |
|              | UP/DOWN mode          | Selects the display that shows elapsed time (UP) or time remaining (DOWN).   | Select UP/DOWN with the increment keys (1 to 4).<br>(UP) U ←→ d (DOWN)  |
|              | Output mode           | Determines the control output type. (Refer to the <i>Operation Modes Timing Charts</i> on pages 18 to 21.)   | Sequence when changing the mode using the increment keys (1 to 4).<br>  |
|              | Output time           | Determines the duration of the control output. Will be displayed when the output mode is A, A-1, A-2, A-3, B, or B-1. Will not be displayed in output modes D, E, or F.  | Use keys 1 to 3 to change the value. Key 1 adjusts the first digit (0.1 digit). Key 2 adjusts the second digit (1 digit). Key 3 adjusts the third digit (10 digit).<br><br>Key 4 selects either hold output or one-shot output.<br>HoLd ←→ 0.0s |
|              | Input signal time     | Changes the duration of the control and reset input signals.   | Change the duration with increment keys (1 to 4).<br>(1 ms) 1 ←→ 20 (20 ms)   |
|              | Key protect level     | Locks certain keys to prevent accidental operation. The key protection level, kP-1 to kP-4, determines which keys are locked when the key protection input is ON. The locked keys are crossed out in the diagram at right. | Sequence when changing the key protect level using the increment keys (1 to 4).<br><br><kP-1><br><br><kP-2><br><br><kP-3><br><br><kP-4><br>   |

- Note:
1. Changes made in setting mode become effective when run mode is entered.
  2. The time range setting appears first when setting mode is entered.

## ■ EXAMPLES

### Run Mode

#### Changing the Set Value

To change the set value from 3 hr 5 min to 4 hr 5 min, press the 3 key so that the number 4 appears in the hour's place.

- Pressing keys 1 through 4 increments the corresponding column by 1.
- The columns can be changed in any order, but the output will be turned ON if the set value is less than the present value.
- Nonsignificant zeros are suppressed on the set value display.

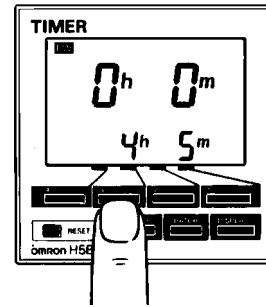

Note: Read *Changing Set Values* in the *Precautions* section before changing the timer set value during operation.

#### Changing the Batch Count Set Value

1. Press the BATCH key to switch from the present value display to the batch count display.

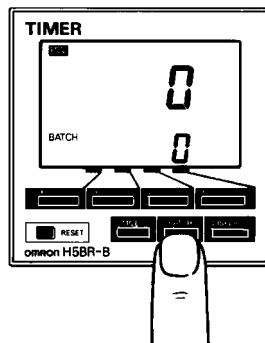

2. Change the set value when the timer is set to the batch count display.

- Nonsignificant zeros are normally suppressed on the batch count set value display.
- Press the DISPLAY key to switch back from the batch count display to the present value display.

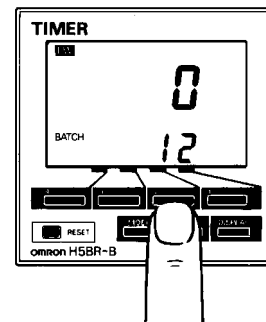

## Setting Mode

### Changing Settings in the Set Mode

- Press the MODE key to switch from run mode to set mode.
  - The timer will continue operation according to existing settings when switched from run mode to set mode during operation.
  - The MODE key will be locked if the key protection function is enabled.
  - Settings changed in the set mode do not take effect until run mode is entered. Because the operating conditions will change once this occurs, always use the RESET key or a reset input to reset operation.

2. Press the MODE key to scroll successively through the items that can be set.

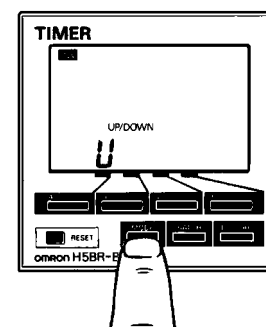
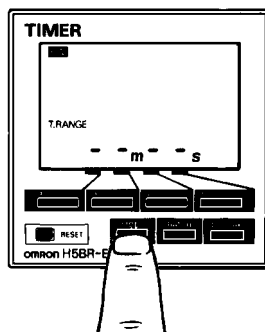

3. To change the selected item,
- Press the MODE key until the desired item appears.

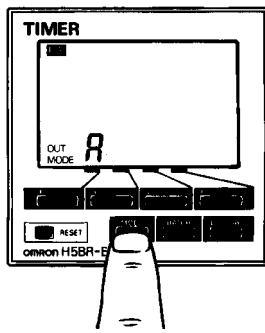

- Change the item setting by pressing keys 1 through 4. (Press the DISPLAY key to switch back from set mode to run mode.)

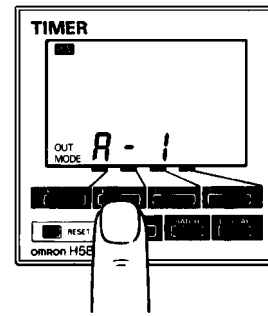

## Precautions

### EXTERNAL POWER SUPPLY

- The capacity of the external power supply is 80 mA at 12 VDC. When using a 24 VAC/12 to 24 VDC power supply, reduce the load with the power supply voltage, as shown in the following diagram (DC power supplies only).

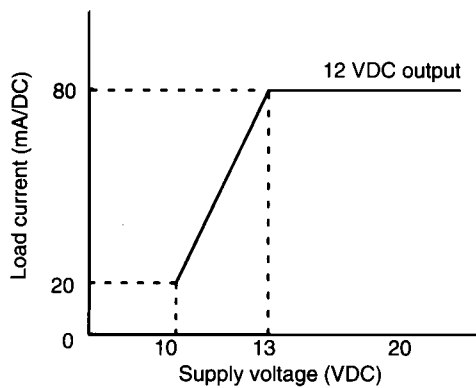

### POWER SUPPLIES

- If power is interrupted for less than 10 ms, operation will continue normally. If power is interrupted for 10 to 500 ms, operation will be inconsistent, and timing may stop or reset, depending on the mode.
- Connect the power supply voltage through a relay or switch in such a way that the voltage reaches a fixed value immediately.
- Depending on switching frequency, current surges may degrade relay contacts; relays with a capacity greater than 10 A are recommended.

### INPUT AND OUTPUT

- Do not use external sources to increase the voltage of input signals (control signal, reset, gate, and key protection).
- Be sure that the load of the control output (contact, transistor) is less than the maximum values indicated in the specifications. If the output load exceeds the recommended value, the life span of the contact output type will be shortened dramatically, and the transistor of the transistor output type will be damaged.
- The transistor output is opto-isolated from the internal circuitry, so either NPN or PNP transistors can be used.

### SELF-DIAGNOSTIC FUNCTION

- The following displays will appear if an error occurs. The present value and output enter the same status as after pressing the RESET key.

| Display | Error  | Output status | Correction         | Set                |
|---------|--------|---------------|--------------------|--------------------|
| E1      | CPU    | OFF           | Press RESET key    | No change          |
| E2      | Memory |               | (batch count to 0) | Set at the factory |

### ■ CHANGING SET VALUES

- The timer set value can be changed while the timer is operating, so a high value can be set temporarily to inactivate the timer, or a low value can be set to activate the timer more quickly. If the set value is changed accidentally during operation, the timed output might be activated. Therefore, turn the key protection input ON unless the set value is being changed.
- To avoid changing the output when changing the set value, it is recommended to begin changing the set value by entering a large number in the higher digit.

### ■ OPERATING ENVIRONMENT

- When using the timer in an area with much electrical noise, separate the timer, wiring, and the equipment which generates the input signals as far as possible from the noise sources. It is also recommended to shield the input signal wiring to prevent electrical interference.
- Organic solvents (such as paint thinner), as well as very acidic or basic solutions, might damage the outer casing of the timer.

### ■ OTHER

- When the timer is installed in a control box and tests are conducted which may damage the timer's internal circuitry (for example, a test measuring the maximum voltage difference between the control circuit and metal components), remove the timer from the control box or short circuit the terminals.

#### CAUTION

This product contains a lithium battery. Lithium batteries explode if incinerated. Dispose of the digital timer as a non-combustible item.

**NOTE: DIMENSIONS ARE SHOWN IN MILLIMETERS. To convert millimeters to inches divide by 25.4.**

# OMRON

## OMRON ELECTRONICS LLC

One East Commerce Drive  
Schaumburg, IL 60173

**1-800-55-OMRON**

Cat. No. GC TMCN1

3/02

## OMRON ON-LINE

Global - <http://www.omron.com>  
USA - <http://www.omron.com/oei>  
Canada - <http://www.omron.com/oci>

Specifications subject to change without notice.

## OMRON CANADA, INC.

885 Milner Avenue  
Scarborough, Ontario M1B 5V8  
**416-286-6465**

Printed in the U.S.A.