

8 PIN DIP 400 V BREAKDOWN VOLTAGE TRANSFER TYPE 2-CH OPTICAL COUPLED MOSFET

PS7141-1C
PS7141L-1C

FEATURES

- **2 CHANNEL TYPE:**
(1a + 1b output)
- **LOW LED OPERATING CURRENT:**
 $I_F = 2 \text{ mA}$
- **DESIGNED FOR AC/DC SWITCHING LINE CHANGER**
- **SMALL PACKAGE:**
8 pin DIP
- **LOW OFFSET VOLTAGE**
- **SURFACE MOUNT AVAILABLE:**
PS7141L-1C

DESCRIPTION

The PS7141-1C and PS7141L-1C are transfer type solid state relays containing normally open (N.O.) contacts and normally closed (N.C.) contacts on the output side. They are suitable for analog signal control because of their low offset and high linearity.

APPLICATIONS

- EXCHANGE EQUIPMENT
- MEASUREMENT EQUIPMENT
- FA/OA EQUIPMENT

ELECTRICAL CHARACTERISTICS ($T_A = 25 \text{ }^\circ\text{C}$)

PART NUMBER			PS7141-1C, PS7141L-1C		
SYMBOLS	PARAMETERS	UNITS	MIN	TYP	MAX
Diode	V_F	Forward Voltage, $I_F = 10 \text{ mA}$		1.2	1.4
	I_R	Reverse Current, $V_R = 5 \text{ V}$	μA		5.0
MOSFET	I_{OFF}	Off-State Leakage Current, N.O.: $I_F = 0 \text{ mA}$, $V_D = 400 \text{ V}$ N.C.: $I_F = 10 \text{ mA}$, $V_D = 400 \text{ V}$	μA	0.03	1.0
	C_{out}	Output Capacitance, N.O.: $V_D = 0 \text{ V}$, $f = 1 \text{ MHz}$ N.C.: $V_D = 0 \text{ V}$, $f = 1 \text{ MHz}$, $I_F = 10 \text{ mA}$	pF/ch	65	185
Coupled	I_{Fon}	LED On-state Current, N.O.: $I_L = 150 \text{ mA}$	mA		2.0
	I_{Foff}	LED Off-state Current, N.C.: $I_L = 150 \text{ mA}$			2.0
	R_{ON1}	On-State Resistance, N.O.: $I_F = 10 \text{ mA}$, $I_L = 10 \text{ mA}$ N.C.: $I_F = 0 \text{ mA}$, $I_L = 10 \text{ mA}$	Ω	20	30
				24	30
	R_{ON2}	N.O.: $I_F = 10 \text{ mA}$, $I_L = 150 \text{ mA}$, $t \leq 10 \text{ ms}$ N.C.: $I_F = 0 \text{ mA}$, $I_L = 150 \text{ mA}$, $t \leq 10 \text{ ms}$		16	25
				16	25
	$t_{\text{ON}}(\text{N.O.})$	Turn-on Time ¹ $I_F = 10 \text{ mA}$, $V_o = 5 \text{ V}$, $PW \geq 10 \text{ ms}$	ms	0.33	1.0
	$t_{\text{ON}}(\text{N.C.})$			0.02	0.2
$t_{\text{OFF}}(\text{N.O.})$	0.03			0.2	
$t_{\text{OFF}}(\text{N.C.})$	0.20			1.0	
$R_{\text{i-o}}$	Isolation Resistance, $V_{\text{i-o}} = 1.0 \text{ kVdc}$	Ω	10^9		
$C_{\text{i-o}}$	Isolation Capacitance, $V = 0 \text{ V}$, $f = 1 \text{ MHz}$	pF/ch		1.1	

Notes:

1. Test Circuit Switching Time:

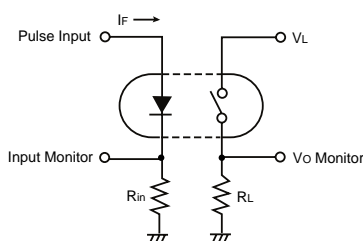

N.O. (between pin 5 and 6)

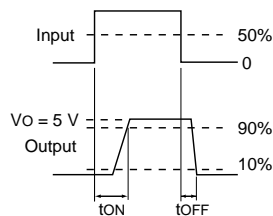

N.C. (between pin 7 and 8)

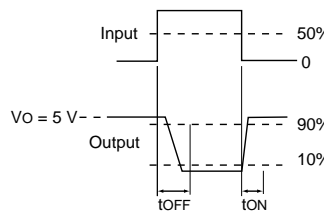

PS7141-1C, PS7141L-1C

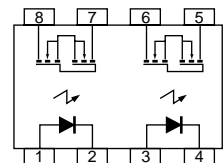

PS7141-1C, PS7141L-1C

ABSOLUTE MAXIMUM RATINGS¹ (T_A = 25°C)

SYMBOLS	PARAMETERS	UNITS	RATINGS
Diode			
I _F	Forward Current (DC)	mA	50
V _R	Reverse Voltage	V	5.0
P _D	Power Dissipation	mW/ch	50
I _{FP}	Peak Forward Current ²	A	1
MOSFET			
V _L	Break Down Voltage	V	400
I _L	Continuous Load Current	mA	150
I _{LP}	Pulse Load Current ³ AC/DC Connection	mA	300
P _D	Power Dissipation	mW/ch	375
BV	Isolation Voltage ⁴	Vr.m.s.	1500
P _T	Total Power Dissipation	mW	850
T _A	Operating Ambient Temp.	°C	-40 to +80
T _{STG}	Storage Temperature	°C	-40 to +100

Notes:

1. Operation in excess of any one of these parameters may result in permanent damage.
2. PW = 100 μs, Duty Cycle = 1 %.
3. PW = 100 ms, 1 shot.
4. AC voltage for 1 minute at T_A = 25 °C, RH = 60 % between input and output.

OUTLINE DIMENSIONS (Units in mm)

PS7141-1C

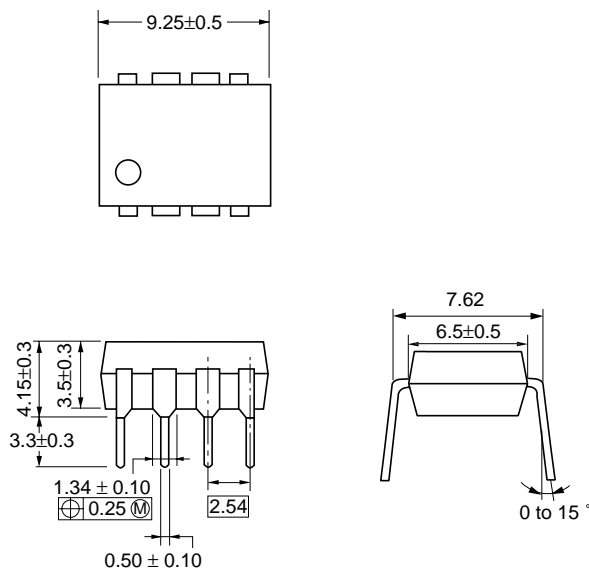

PS7141L-1C

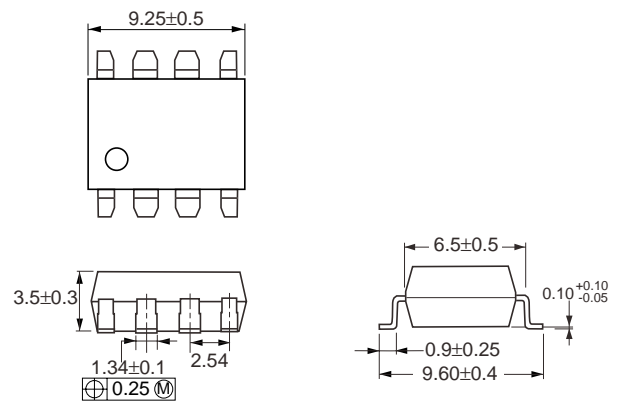

PIN CONNECTION (Top View)

PS7141-1C, PS7141L-1C

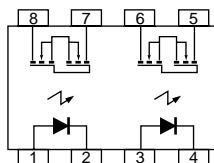

1. LED Anode (N.C.)
2. LED Cathode (N.C.)
3. LED Anode (N.O.)
4. LED Cathode (N.O.)
5. MOSFET (N.O.)
6. MOSFET (N.O.)
7. MOSFET (N.C.)
8. MOSFET (N.C.)

RECOMMENDED OPERATING CONDITIONS (T_A = 25°C)

PART NUMBER		PS7141-1C, PS7141L-1C			
SYMBOLS	PARAMETERS	UNITS	MIN	TYP	MAX
I _F	LED Operating Current	mA	2	10	20
V _F	LED Off Voltage	V	0		0.5

ORDERING INFORMATION

PART NUMBER	PACKAGE	PACKING STYLE
PS7141-1C	8-PIN DIP	Magazine case 50 pcs
PS7141L-1C		
PS7141L-1C-E3		Embossed Tape 1000 pcs/reel
PS7141L-1C-E4		

TYPICAL PERFORMANCE CURVES (TA = 25 °C)

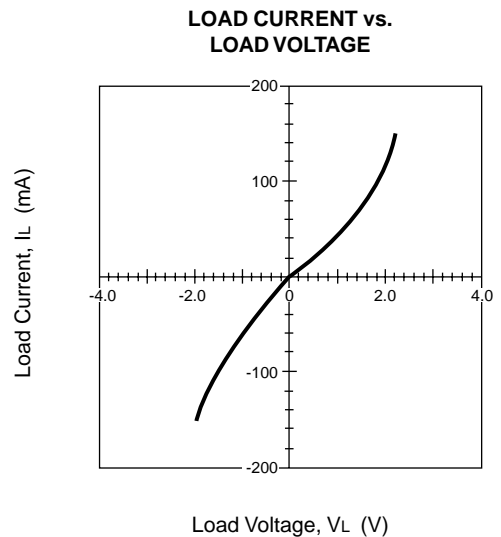
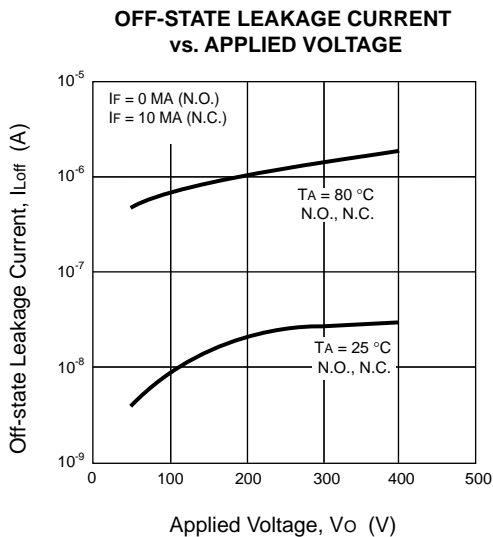
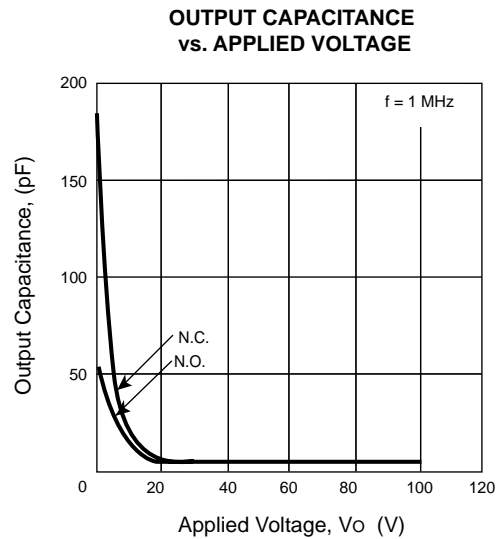
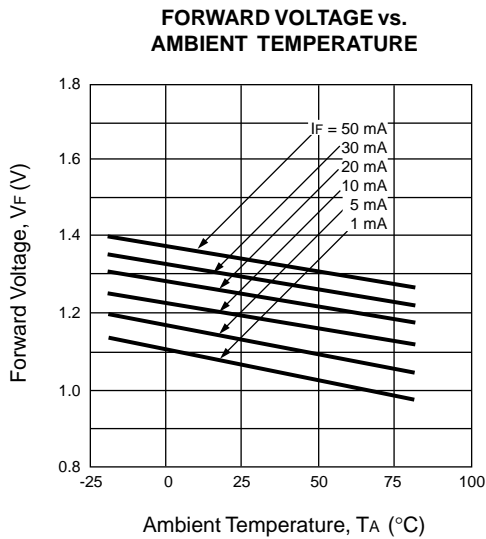
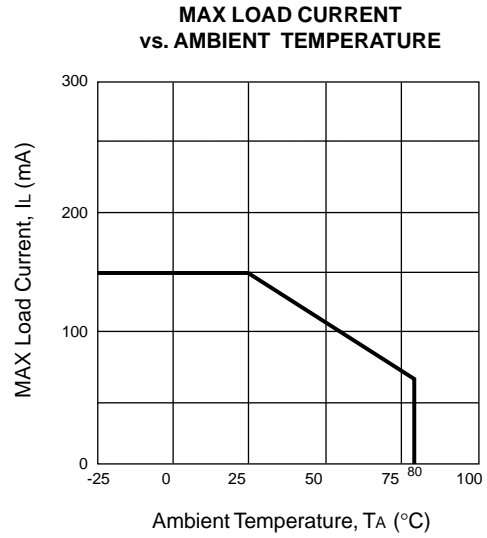
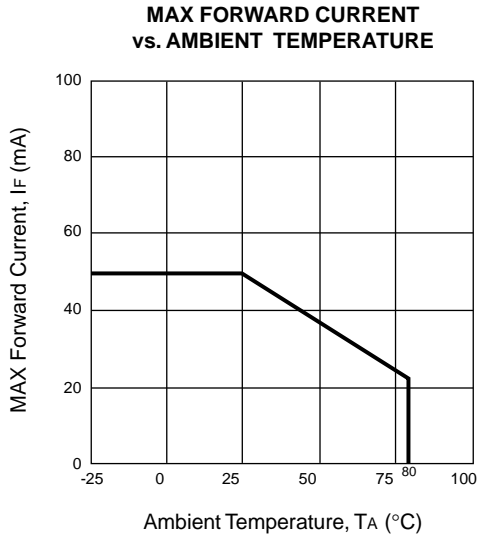

TYPICAL PERFORMANCE CURVES (TA = 25 °C)

TURN-ON TIME vs. FORWARD CURRENT

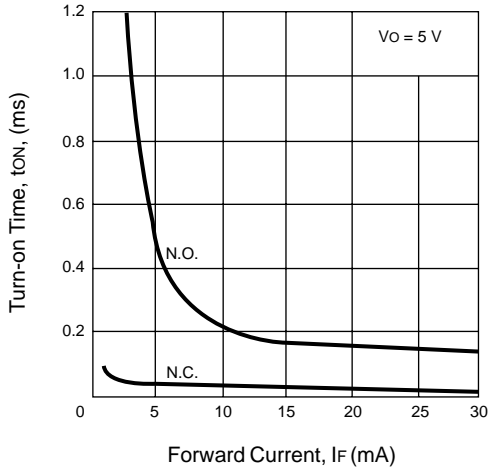

TURN-OFF TIME vs. FORWARD CURRENT

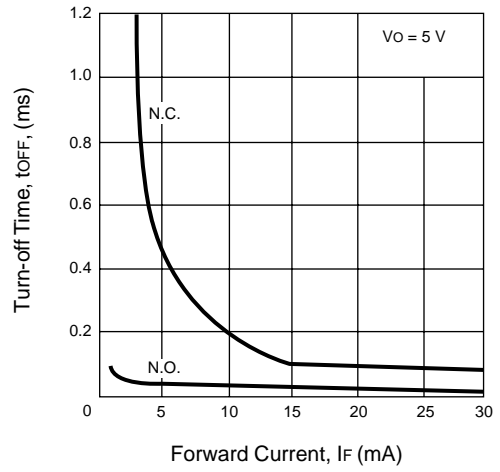

NORMALIZED TURN-ON TIME vs. AMBIENT TEMPERATURE

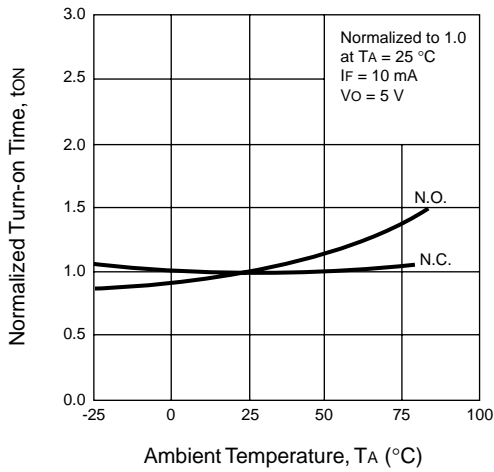

NORMALIZED TURN-OFF TIME vs. AMBIENT TEMPERATURE

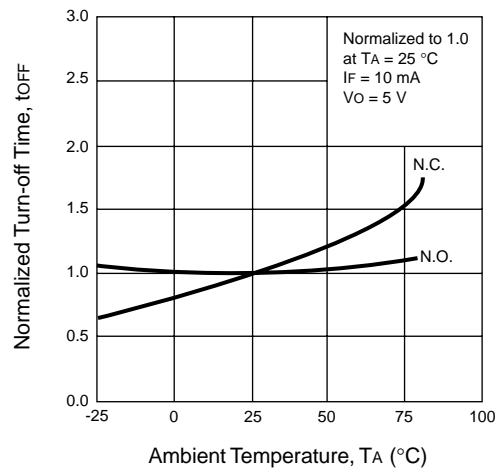

NORMALIZED ON-STATE RESISTANCE vs. AMBIENT TEMPERATURE

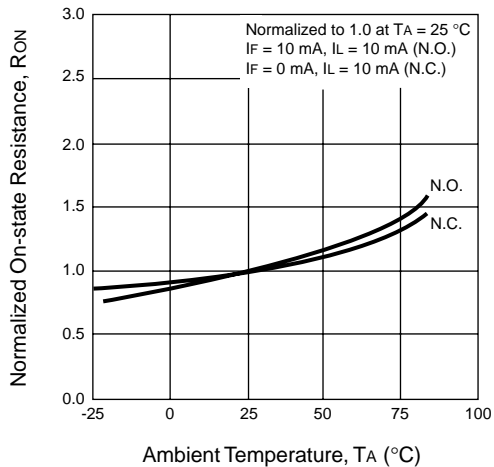

TYPICAL PERFORMANCE CURVES (T_A = 25 °C)

ON-STATE RESISTANCE (N.O.) DISTRIBUTION

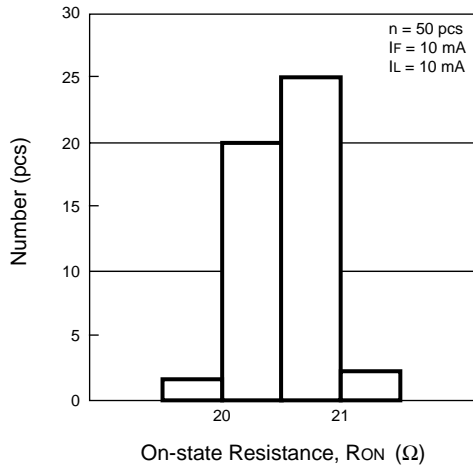

ON-STATE RESISTANCE (N.C.) DISTRIBUTION

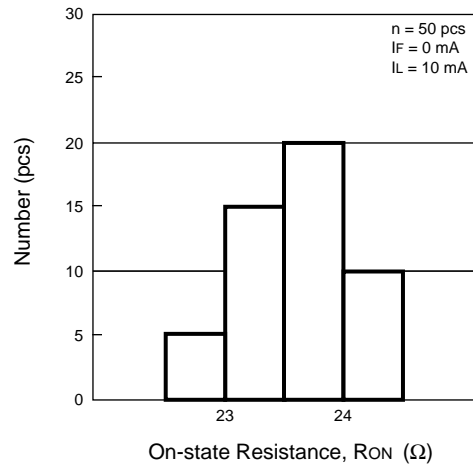

TURN-ON TIME (N.O.) DISTRIBUTION

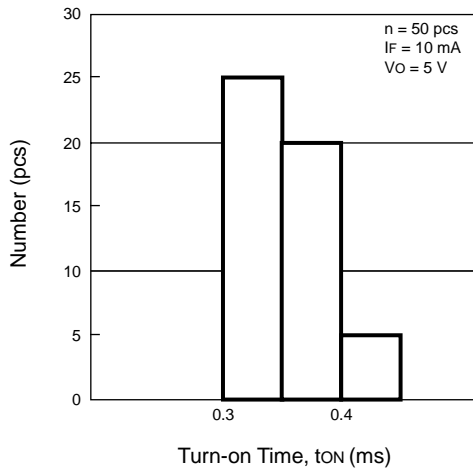

TURN-ON TIME (N.C.) DISTRIBUTION

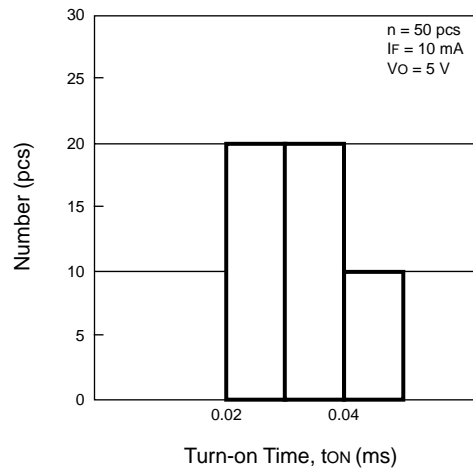

TURN-OFF TIME (N.O.) DISTRIBUTION

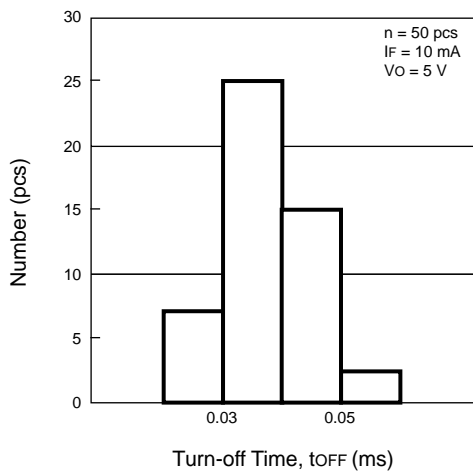

TURN-OFF TIME (N.C.) DISTRIBUTION

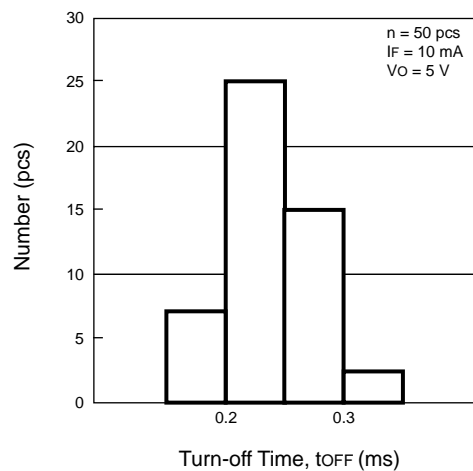

TAPING SPECIFICATIONS (Units in mm)

OUTLINE AND DIMENSIONS (TAPE)

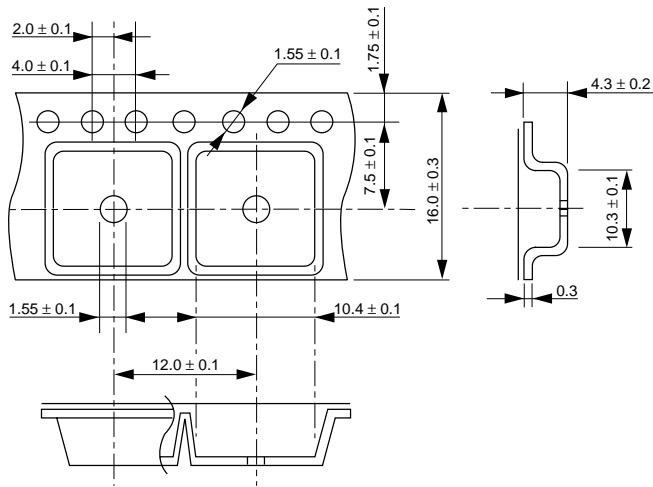

OUTLINE AND DIMENSIONS (REEL)

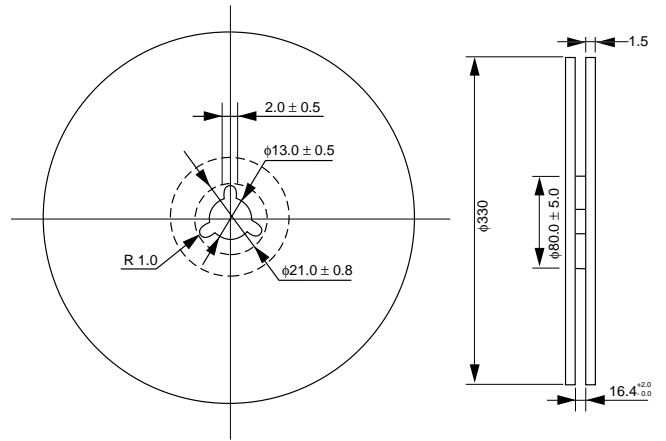

Packaging : 1000 pcs/reel

TAPING DIRECTION

PS7141L-1C-E3

PS7141L-1C-E4

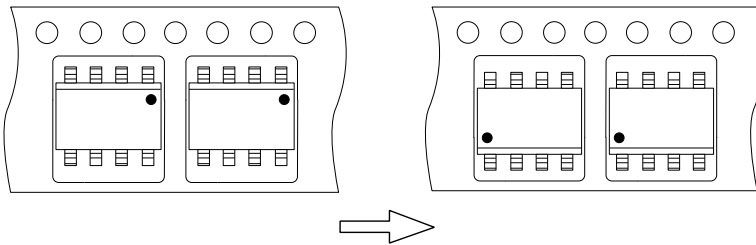

RECOMMENDED SOLDERING CONDITIONS

(1) Infrared reflow soldering

- Peak reflow temperature 235 °C or below (package surface temperature)
- Time of temperature higher than 210 °C 30 seconds or less
- Number of reflows Two
- Flux Rosin flux containing small amount of chlorine
(The flux with a maximum chlorine content of 0.2 Wt % is recommended.)

Recommended Temperature Profile of Infrared Reflow

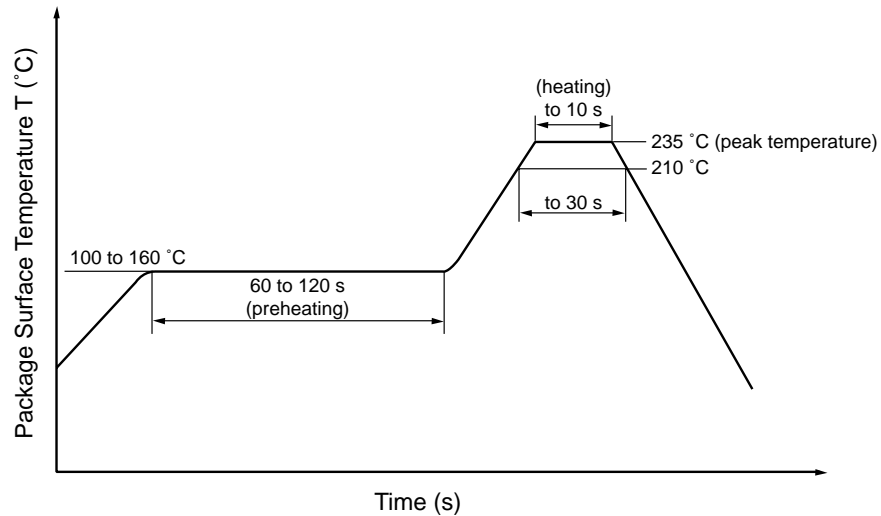

(2) Dip soldering

- Temperature 260 °C or below (molten solder temperature)
- Time 10 seconds or less
- Number of times One
- Flux Rosin flux containing small amount of chlorine
(The flux with a maximum chlorine content of 0.2 Wt % is recommended.)

(3) Cautions

- Fluxes
Avoid removing the residual flux with freon-based cleaning solvent.

EXCLUSIVE NORTH AMERICAN AGENT FOR NEC RF, MICROWAVE & OPTOELECTRONIC SEMICONDUCTORS

CEL CALIFORNIA EASTERN LABORATORIES • Headquarters • 4590 Patrick Henry Drive • Santa Clara, CA 95054-1817 • (408) 988-3500 • Telex 34-6393 • FAX (408) 988-0279

DATA SUBJECT TO CHANGE WITHOUT NOTICE

Internet: <http://WWW.CEL.COM>

10/11/2001