

FEATURES

- **DESIGNED FOR AC/DC SWITCHING APPLICATIONS**
- **IDEAL FOR ANALOG SIGNAL CONTROL APPLICATIONS**
- **LOW LED OPERATING CURRENT:**
 $I_F = 2 \text{ mA}$
- **LOW OFFSET VOLTAGE**
- **SMALL PACKAGE:**
6 Pin DIP

DESCRIPTION

PS7112-1A and PS7112L-1A are solid state relays containing a GaAs LED on the light emitting side (input side) and MOSFETs on the output side.

APPLICATIONS

- **VOICE TELEPHONY**
- **AUDIO EQUIPMENT**
- **AUDIO INSTRUMENTATION**

ELECTRICAL CHARACTERISTICS (T_A = 25 °C)

PART NUMBER			PS7112-1A, PS7112L-1A			
	SYMBOLS	PARAMETERS	UNITS	MIN	TYP	MAX
Diode	V _F	Forward Voltage, I _F = 10 mA	V		1.2	1.4
	I _R	Reverse Current, V _R = 5 V	μA			5.0
MOSFET	I _{LOFF}	Off-State Leakage Current, V _D = 100 V	μA		0.03	1
	C _{OUT}	Output Capacitance, V _D = 0 V, f = 1 MHz			57	
Coupled	I _{Fon}	LED On-state Current, I _L = 200 mA	mA			2.0
	RON1	On-State Resistance, I _F = 10 mA, I _L = 10 mA	Ω		3.0	6.0
	RON2					
	t _{ON}	Turn-on Time I _F = 10 mA, V _O = 5 V, PW ≥ 10 ms	ms		0.1	0.4
	t _{OFF}	Turn-off Time I _F = 10 mA, V _O = 5 V, PW ≥ 10 ms	ms		0.03	0.2
	R _{I-O}	Isolation Resistance, V _{I-O} = 1.0 kVDC	Ω	10 ⁹		
	C _{I-O}	Isolation Capacitance, V = 0 V, f = 1 MHz	pF		1.1	

Note:

1. Test Circuit for Switching Time:

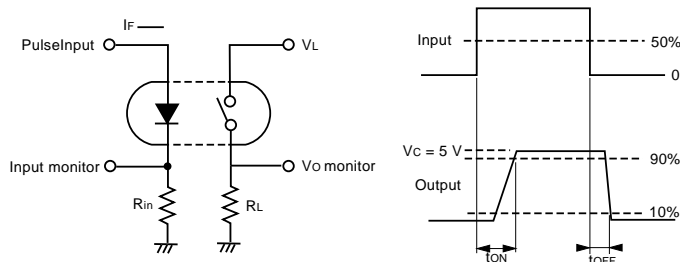

PS7112-1A, PS7112L-1A

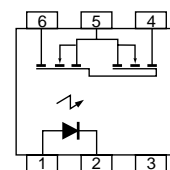

PS7112-1A, PS7112L-1A

ABSOLUTE MAXIMUM RATINGS¹ (T_A = 25°C)

SYMBOLS	PARAMETERS	UNITS	RATINGS
Diode			
I _F	Forward Current (DC)	mA	50
V _R	Reverse Voltage	V	5
P _D	Power Dissipation	mW	50
I _{FP}	Peak Forward Current ²	A	1
MOSFET			
V _L	Break Down Voltage	V	100
I _L	Continuous Load Current ³	mA	200
	Connection A		
	Connection B		
	Connection C		400
I _{LP}	Pulse Load Current ⁴ (AC/DC Connection)	mA	400
P _D	Power Dissipation	mW	560
Coupled			
BV	Isolation Voltage ⁵	V _{R.M.S.}	1500
P _T	Total Power Dissipation	mW	610
T _{OP}	Operating Temperature	°C	-40 to +80
T _{STG}	Storage Temperature	°C	-40 to +100

Notes:

- Operation in excess of any one of these parameters may result in permanent damage.
- PW = 100 μs, Duty Cycle = 1 %
- Conditions: I_F ≥ 2 mA. The following types of load connections are available:

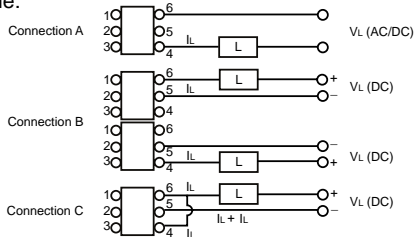

- PW = 100 ms, 1 shot.
- AC voltage for 1 minute at T_A = 25 °C, RH = 60 % between input and output.

RECOMMENDED OPERATING CONDITIONS (T_A = 25°C)

PART NUMBER		PS7112-1A, PS7112L-1A			
SYMBOLS	PARAMETERS	UNITS	MIN	TYP	MAX
I _F	LED Operating Current	mA	2	10	20
V _F	LED Off Voltage	V	0		0.5

ORDERING INFORMATION

PART NUMBER	PACKAGE	PACKING STYLE
PS7112-1A	6-pin DIP	Magazine case 50 pcs
PS7112L-1A		
PS7112L-1A-E3		
PS7112L-1A-E4		Embossed Tape 1000 pcs/reel

OUTLINE DIMENSIONS (Units in mm)

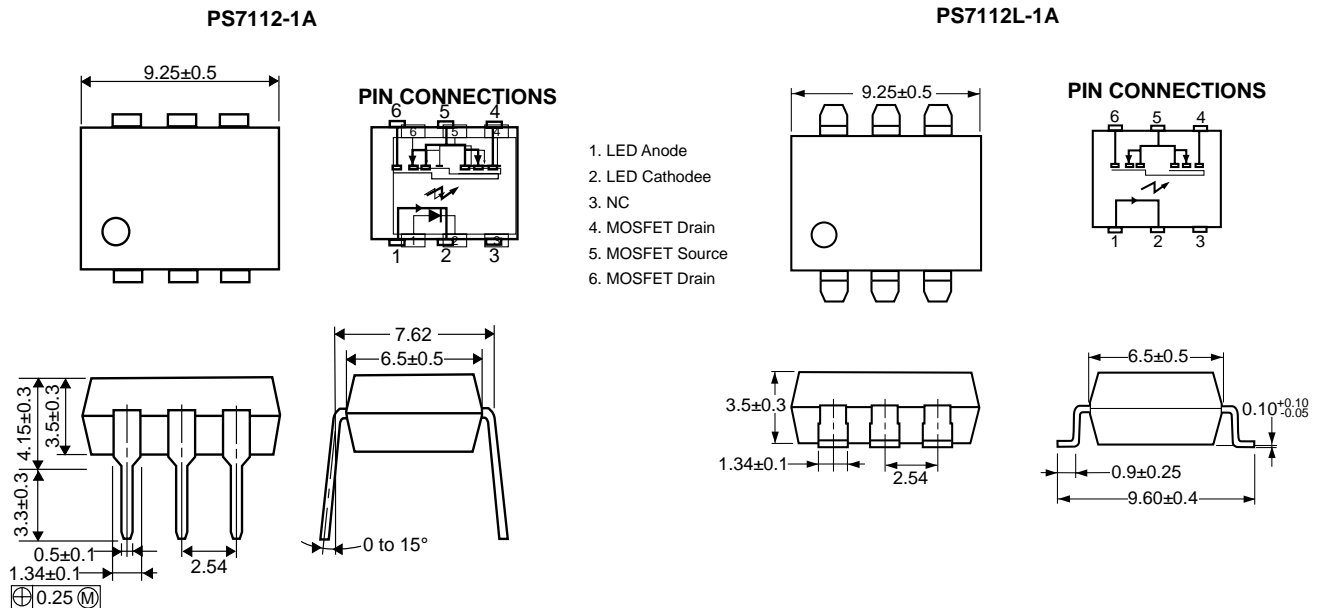

- LED Anode
- LED Cathode
- NC
- MOSFET Drain
- MOSFET Source
- MOSFET Drain

TYPICAL PERFORMANCE CURVES ($T_A = 25\text{ }^\circ\text{C}$)

MAXIMUM FORWARD CURRENT vs. AMBIENT TEMPERATURE

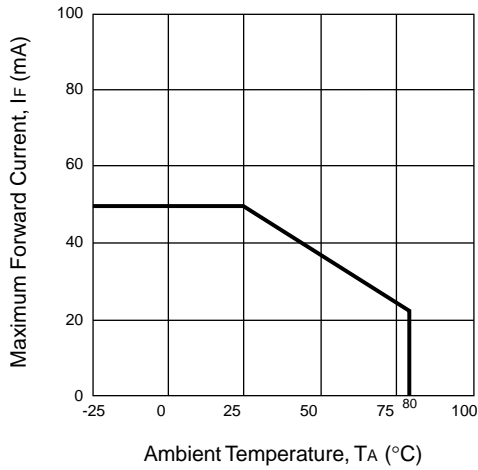

MAXIMUM LOAD CURRENT vs. AMBIENT TEMPERATURE

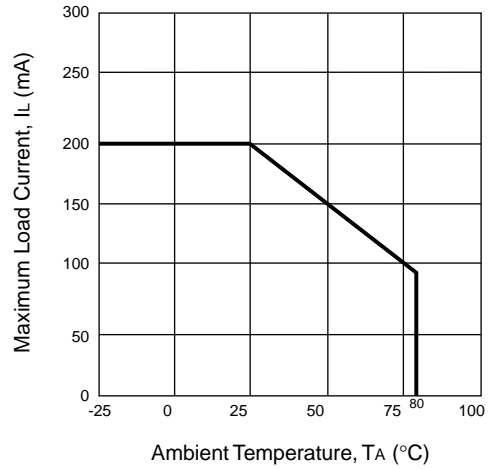

FORWARD VOLTAGE vs. AMBIENT TEMPERATURE

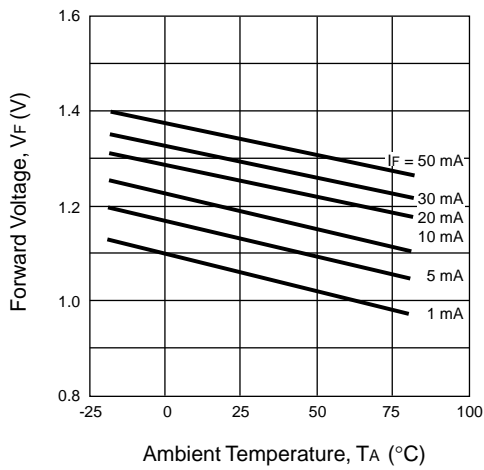

OUTPUT CAPACITANCE vs. SUPPLY VOLTAGE

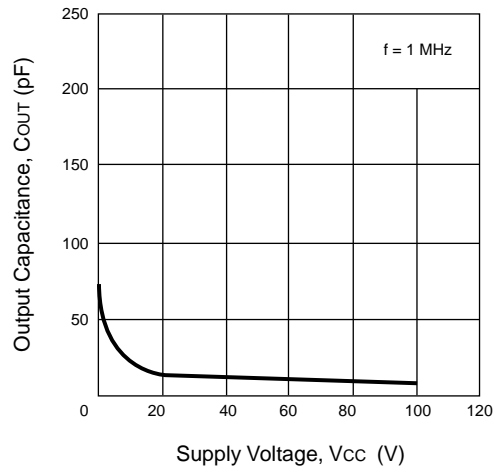

NORMALIZED ON-STATE RESISTANCE vs. AMBIENT TEMPERATURE

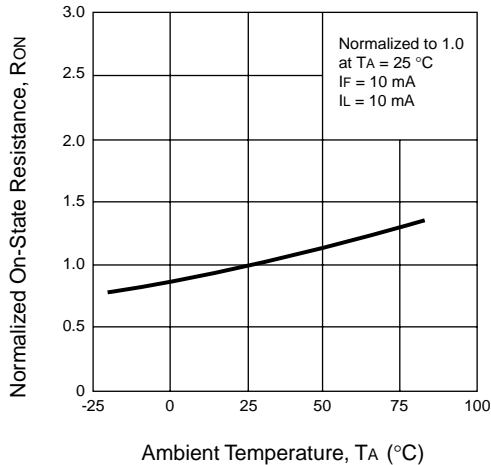

ON-STATE RESISTANCE DISTRIBUTION

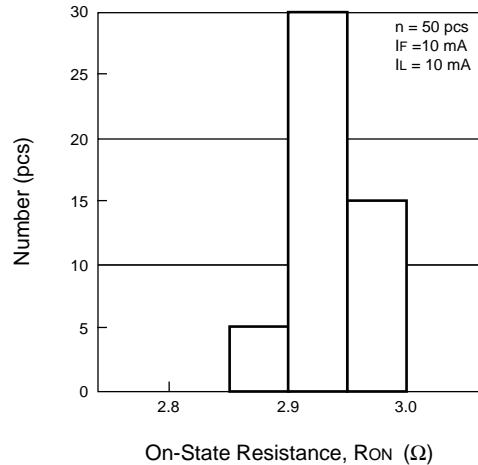

TYPICAL PERFORMANCE CURVES (TA = 25 °C)

OFF-STATE LEAKAGE CURRENT vs. SUPPLY VOLTAGE

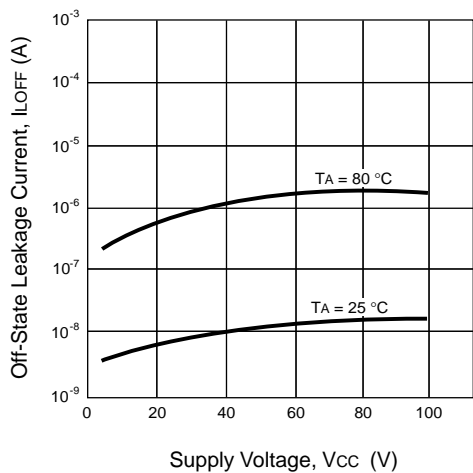

LOAD CURRENT vs. LOAD VOLTAGE

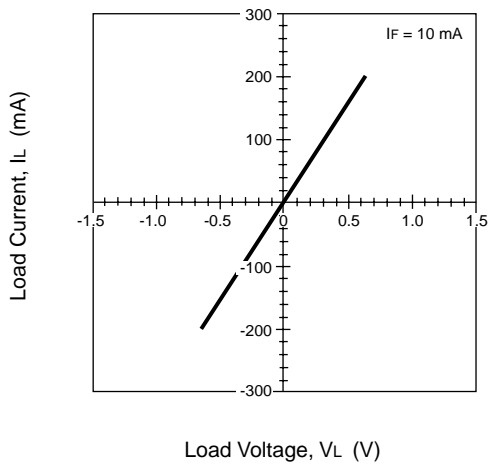

TURN-ON TIME vs. FORWARD CURRENT

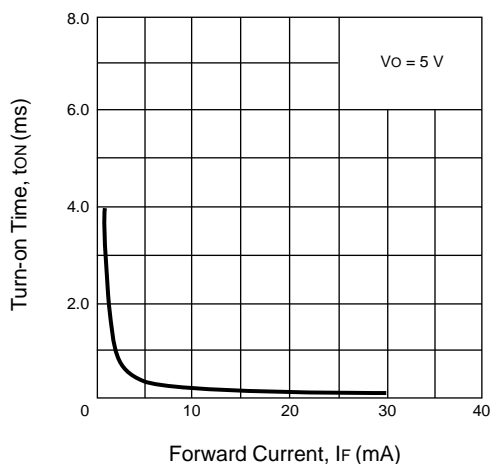

TURN-OFF TIME vs. FORWARD CURRENT

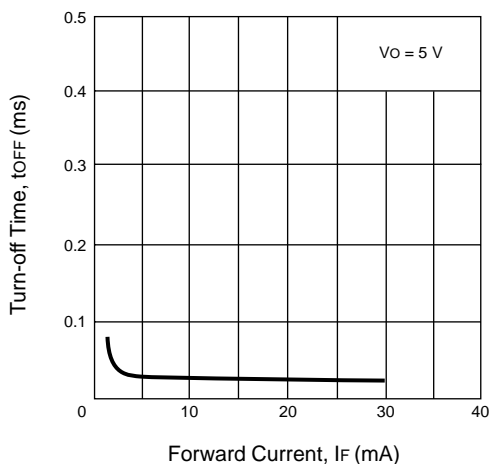

TURN-ON TIME DISTRIBUTION

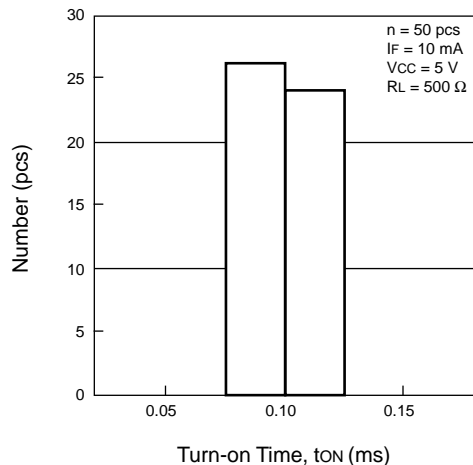

TURN-OFF TIME DISTRIBUTION

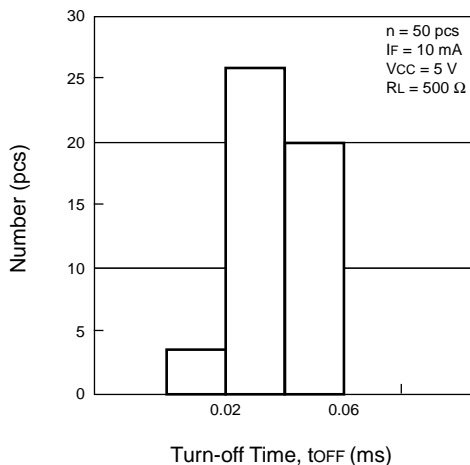

TYPICAL PERFORMANCE CURVES ($T_A = 25\text{ }^\circ\text{C}$)

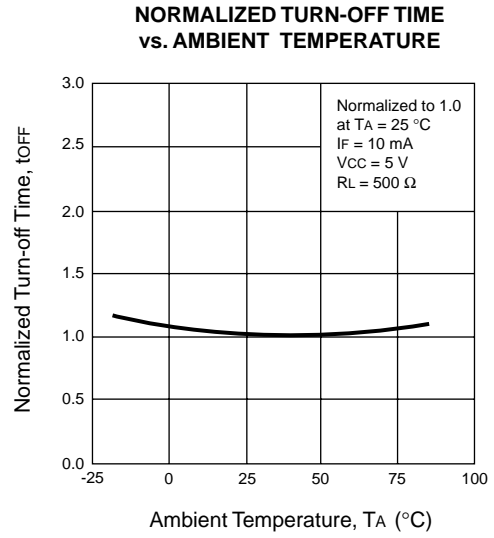
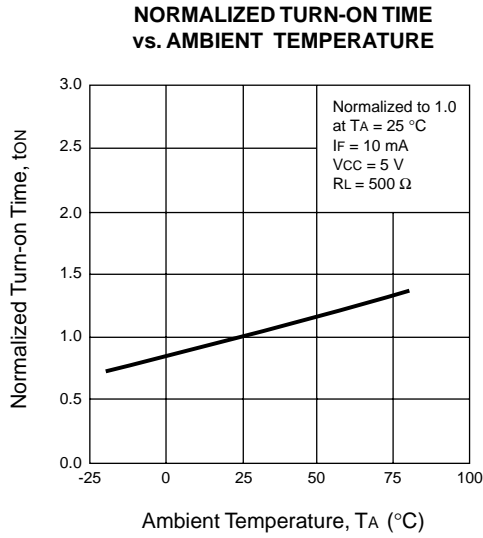

TAPING SPECIFICATIONS (Units in mm)

OUTLINE AND DIMENSIONS (TAPE)

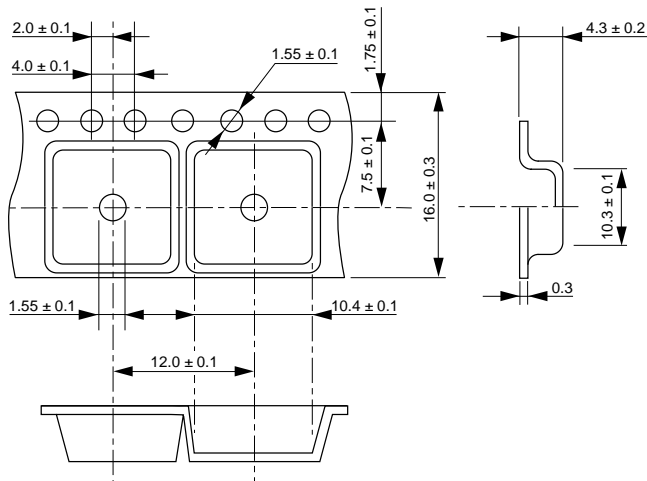

OUTLINE AND DIMENSIONS (REEL)

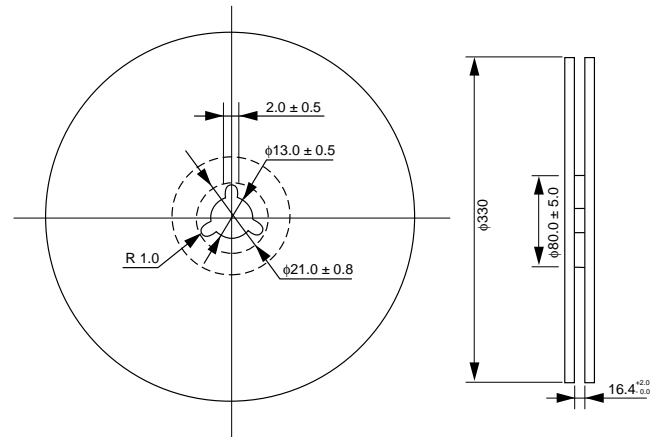

Packaging : 1000 pcs/reel

TAPING DIRECTION

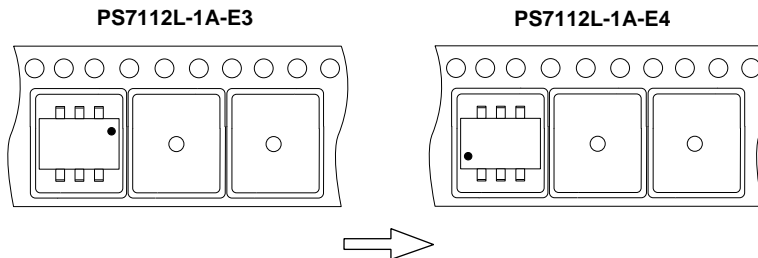

RECOMMENDED SOLDERING CONDITIONS

(1) Infrared reflow soldering

- Peak reflow temperature 235 °C or below (package surface temperature)
- Time of temperature higher than 210 °C 30 seconds or less
- Number of reflows Two
- Flux Rosin flux containing small amount of chlorine
(The flux with a maximum chlorine content of 0.2 Wt % is recommended.)

Recommended Temperature Profile of Infrared Reflow

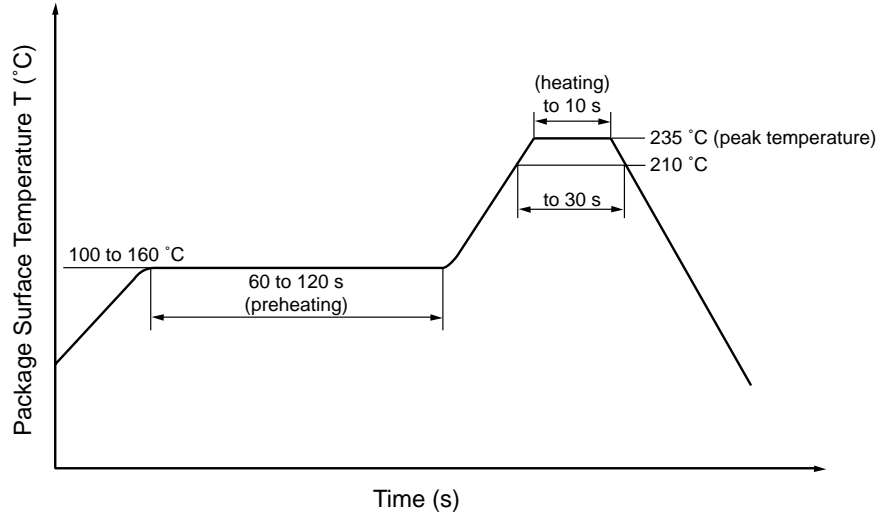

(2) Dip soldering

- Temperature 260 °C or below (molten solder temperature)
- Time 10 seconds or less
- Number of times One
- Flux Rosin flux containing small amount of chlorine
(The flux with a maximum chlorine content of 0.2 Wt % is recommended.)

(3) Cautions

- Fluxes Avoid removing the residual flux with freon-based cleaning solvent.