

# Solid-State Relays

## Panel Mount Package—VAC Input / VAC Output

### OSSRA0007A thru OSSRA0012A



#### Features:

- Molded Epoxy package
- Zero crossing circuit
- High Input/output Optical Isolation 4k Vrms
- Superior heat sink package
- Includes LED indicator
- Fast switching time
- Non-contact switch

#### Approval Agency:

- UL Certification No: E321810



#### Description:

The OSSR Solid State Relay series are electronic controlled switches, they contain no moving parts. When voltage is applied to the input, a Light Emitting Diode or LED illuminates a Photosensor which controls the internal output circuit. The output circuit is utilized to drive high current loads. The input and output are optically isolated. The OSSR series incorporates a zero crossing circuit which minimizes current and noise surges due to resistive and inductive loads. Optek provides three different electrical configurations of the OSSR series: DC input – AC output, AC input – AC output and DC input – DC output. These configurations meet most industry applications.

The **OSSRA000XA** family comes in a standard panel mount package, commonly known as a “hockey puck” package. The package offers a robust molded epoxy body with exceptional thermal dissipation capability for a long reliable operational life.

The input circuit consists of a bridge rectifier circuit which features an AC range from 50 to 250 ADC. The output consists of a Double Triac circuit featuring load current ratings from 10 to 40 Amps and maximum load voltages from 250 to 480VAC with normally open output.

Protective plastic covers are included with shipment of OSSRA series.  
Installation of the protection cover is necessary.

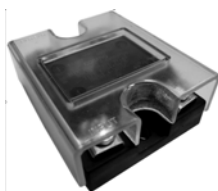

#### Applications:

- Temperature controlled systems
- Office equipment
- Motor controls
- Industrial Equipment
- Light controls systems
- Heater control
- Appliances
- HVAC temperature control
- Plastic molding
- Packaging industry
- Food processing temperature controls



Moisture

OPTEK reserves the right to make changes at any time in order to improve design and to supply the best product possible.

# Solid-State Relays

## Panel Mount Package—VAC Input / VAC Output

### OSSRA0007A thru OSSRA0012A



#### Package Outline Dimensions: Panel Mount

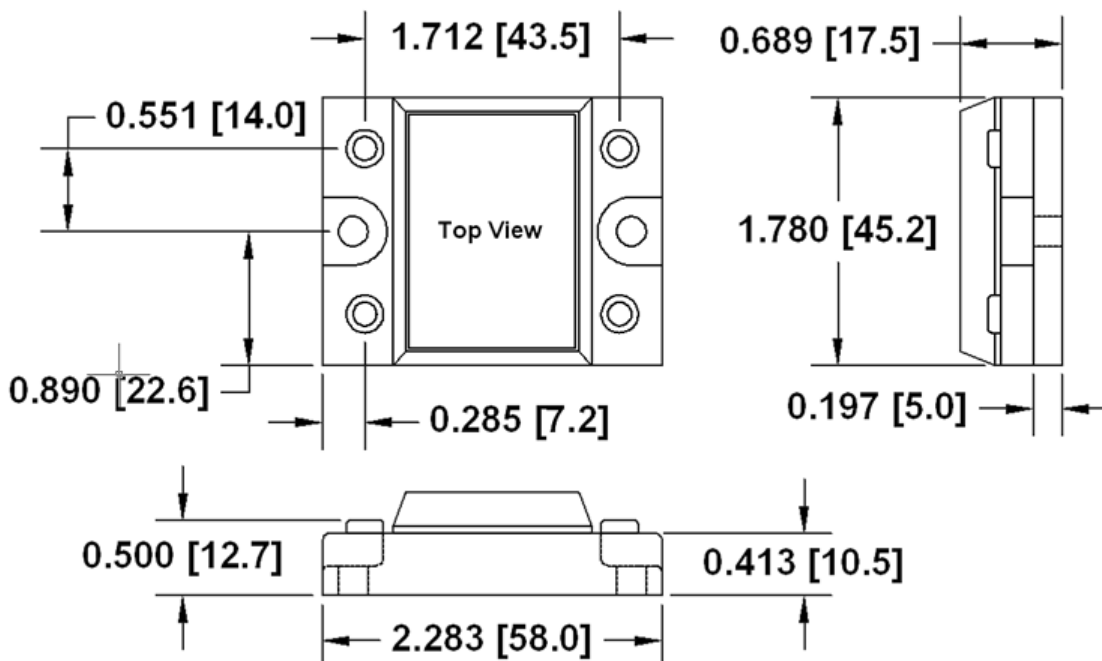

All dimensions in: inches [millimeters]  
Tolerance:  $\pm 0.004$ " [0.10mm]

#### Schematic: Top View

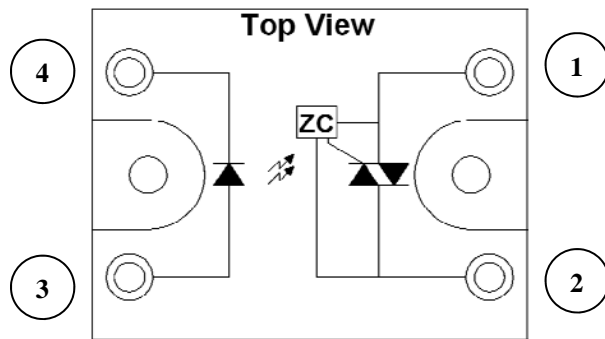

OSSRA0007A thru OSSRA0012A

#### Pin Configuration

Part Number	Pin #			
	1	2	3	4
OSSRA0007A	A (-)	A (+)	A	K
OSSRA0008A	A (-)	A (+)	A	K
OSSRA0009A	A (-)	A (+)	A	K
OSSRA0010A	A (-)	A (+)	A	K
OSSRA0011A	A (-)	A (+)	A	K
OSSRA0012A	A (-)	A (+)	A	K

OPTEK reserves the right to make changes at any time in order to improve design and to supply the best product possible.

# Solid-State Relays

## Panel Mount Package—VAC Input / VAC Output

### OSSRA0007A thru OSSRA0012A



### VAC Input / VAC Output Devices Ordering Information

Part Number	Input	Min. Tgr Current I <sub>T</sub>	Max. Output Current	Min. Ouput Current	Max. Vout	Min. Vout	Output Type	Br. Vol. Input to Output	Configuration
OSSRA0007A	100-240VAC	50mA	10A	0.05A	250VAC	50VAC	AC	4000VAC	A K —A1(+) A2(-)
OSSRA0008A	100-240VAC	50mA	15A	0.05A	250VAC	50VAC	AC	4000VAC	A K —A1(+) A2(-)
OSSRA0009A	100-240VAC	50mA	25A	0.05A	250VAC	50VAC	AC	4000VAC	A K —A1(+) A2(-)
OSSRA0010A	100-240VAC	50mA	40A	0.05A	250VAC	50VAC	AC	4000VAC	A K —A1(+) A2(-)
OSSRA0011A	100-240VAC	50mA	25A	0.05A	480VAC	75VAC	AC	4000VAC	A K —A1(+) A2(-)
OSSRA0012A	100-240VAC	50mA	40A	0.05A	480VAC	75VAC	AC	4000VAC	A K —A1(+) A2(-)

Configuration: Definition of Terms

LED Identification—Sensor Identification

Configuration Information	LED	A = Anode , K = Cathode
	Sensor	A1(+) and A2(-) = Main Terminals of Double Triac

### Part Number Symbolization

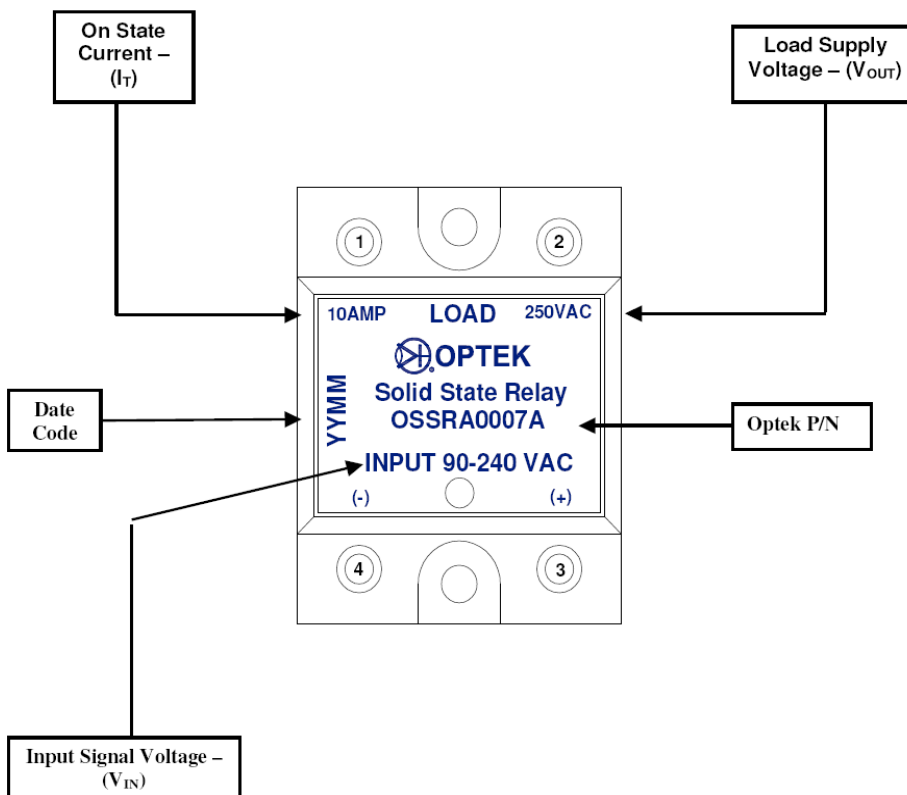

OPTEK reserves the right to make changes at any time in order to improve design and to supply the best product possible.

# Solid-State Relays

## Panel Mount Package—VAC Input / VAC Output

### OSSRA0007A thru OSSRA0012A



#### Absolute Maximum Ratings ( $T_A = 25^\circ\text{C}$ unless otherwise noted)

<b>Storage Temperature</b> OSSRA0007A thru OSSRA0012A	-30° C to +100° C
<b>Operating Temperature</b> OSSRA0007A thru OSSRA0012A	-30° C to +80° C
<b>Isolation Voltage (Input to Output)</b> OSSRA0007A thru OSSRA0012A	4,000 Vrms

#### Input Diode

<b>Input Signal Voltage—(<math>V_{IN}</math>)</b> OSSRA0007A thru OSSRA0012A	100– 240 VAC
<b>Drop-out Voltage—(<math>V_{do}</math>)</b> OSSRA0007A thru OSSRA0012A	10 VAC

#### Output Triac

<b>RMS On-State Current - (<math>I_T</math>)</b> OSSRA0007A OSSRA0008A OSSRA0009A, OSSRA0011A OSSRA0010A, OSSRA0012A	10 Arms 15 Arms 25 Arms 40 Arms
<b>Peak One Cycle Surge Current - (<math>I_{surge}</math>)</b> OSSRA0007A OSSRA0008A OSSRA0009A, OSSRA0011A OSSRA0010A, OSSRA0012A	100 A 150 A 250 A 400 A
<b>Repetitive Peak-Off State Voltage—(<math>V_{DRM}</math>)</b> OSSRA0007A thru OSSRA0010A OSSRA0011A, OSSRA0012A	600 V 800 V
<b>Operating Frequency—(<math>f</math>)</b> OSSRA0007A thru OSSRA0012A	47—70 Hz
<b>Critical Rate of Rise of On-State Current—(<math>di/dt</math>)</b> OSSRA0007A thru OSSRA0012A	50 A/ $\mu\text{S}$ 50 V/ $\mu\text{S}$
<b>Load Supply Voltage—(<math>V_{OUT}</math>)</b> OSSRA0007A thru OSSRA0010A OSSRA0011A, OSSRA0012A	250 Vrms AC 480 Vrms AC

OPTEK reserves the right to make changes at any time in order to improve design and to supply the best product possible.

# Solid-State Relays

## Panel Mount Package—VAC Input / VAC Output

### OSSRA0007A thru OSSRA0012A



#### Electrical Characteristics

SYMBOL	PARAMETER	MIN	TYP	MAX	UNIT	TEST CONDITIONS
--------	-----------	-----	-----	-----	------	-----------------

#### Input Diode

$V_{PU}$	<b>Pick-up Voltage</b> OSSRA0007A thru OSSRA0012A	-	-	100	VAC	$R_{IN} = 11K\Omega$
$R_{IN}$	<b>Input Resistance</b> OSSRA0007A thru OSSRA0012A	-	11	-	K $\Omega$	

#### Output Triac

$V_T$	<b>On-State Voltage</b> OSSRA0007A thru OSSRA0012A	-	-	1.5	Vrms	$I_T = 1Arms$
$I_{OP}$	<b>Operating Current</b> OSSRA0007A thru OSSRA0010A OSSRA0011A, OSSRA0012A	50 50	- -	- -	mArms	$V_{out} = 240Vrms$ $V_{out} = 480Vrms$
$I_{LEAK}$	<b>Leakage Current</b> OSSRA0007A thru OSSRA0010A OSSRA0011A, OSSRA0012A	- -	3.5 -	8 14	mArms	$V_{out} = 240Vrms$ $V_{out} = 480Vrms$
dv/dt	<b>Critical Rate of Rise of Off-State Voltage</b> OSSRA0011A, OSSRA0012A OSSRA0007A thru OSSRA0010A	50 100	150 -	- -	V/ $\mu s$	See Note 1.
-	<b>Zero-Cross Voltage</b> OSSRA0007A thru OSSRA0012A	-	Yes	-	-	-
$V_{OUT}$	<b>Load Voltage Rating</b> OSSRA0007A thru OSSRA0010A OSSRA0011A, OSSRA0012A	50 75	- -	280 480	VAC	$I_T = 50mArms$ MIN
$I_{FT}$	<b>Minimum Trigger Current</b> OSSRA0007A, thru OSSRA0009A OSSRA0010A thru OSSRA0012A	- -	- -	25 25	mA	$V_{DRM} = 600 V$ $V_{DRM} = 800 V$
Riso	<b>Isolation resistance Input to Output</b> OSSRA0007A thru OSSRA0012A	$10^{10}$	-	-	$\Omega$	DC500 V
$T_{ON}$	<b>Turn-on Time</b> OSSRA0007A thru OSSRA0012A	-	-	8.3	mS	60Hz AC
$T_{OFF}$	<b>Turn-off Time</b> OSSRA0007A thru OSSRA0012A	-	-	8.3	mS	60Hz AC
Rth (j-c)	<b>Thermal Resistance (between junction and case)</b>	-	1.3	-	$^{\circ}C/W$	-

**Note1:** Output (dv/dt) protection is provided in all models, and they are designed to switch resistive or inductive loads to 0.2 factor. The dv/dt rating is based on source impedance of 50 ohms.

OPTEK reserves the right to make changes at any time in order to improve design and to supply the best product possible.

# Solid-State Relays

## Panel Mount Package—VAC Input / VAC Output

### OSSRA0007A thru OSSRA0012A



### OSSRA0007A thru OSSRA0010A

#### Characteristic Data Curves

**Fig.1** RMS On-state Current vs. Ambient Temperature

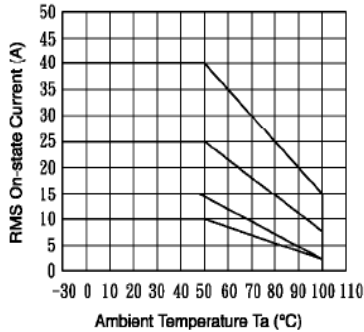

**Fig.2** Surge Current vs. Time  
f=60Hz  
Tj=25°C

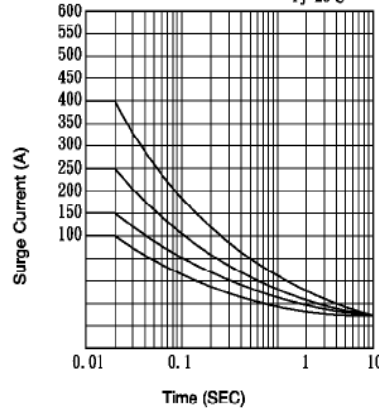

**Fig.3** Open Circuit Leak Current vs. Supply Voltage  
Ta=25°C

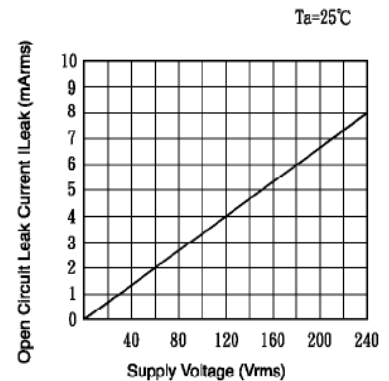

**Fig.4** RMS On-state Current vs. Case Temperature

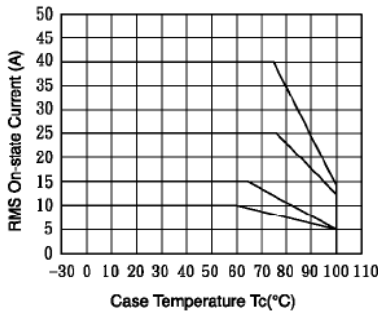

**Fig.5** Input Voltage vs. Ambient Temperature

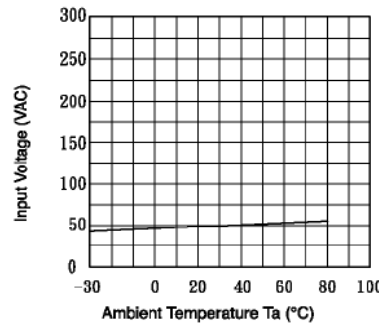

**Fig.6** Input Current vs. Input voltage

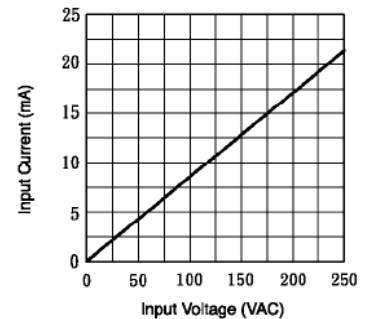

**Fig.7** Action waveform

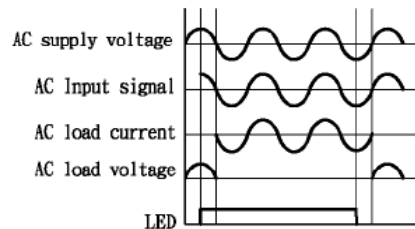

**Fig.8** WIRING DIAGRAM

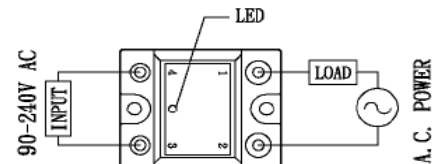

OPTEK reserves the right to make changes at any time in order to improve design and to supply the best product possible.

# Solid-State Relays

## Panel Mount Package—VAC Input / VAC Output

### OSSRA0007A thru OSSRA0012A

### OSSRA0011A

#### Characteristic Data Curves

**Fig.1 RMS On-state Current vs. Ambient Temperature**

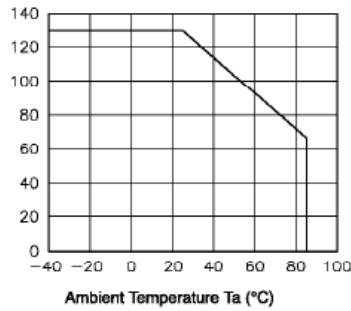

**Fig.2 Surge Current vs. Time**  
f=60Hz  
Tj=25°C

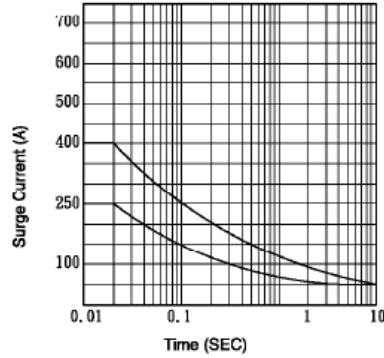

**Fig.3 Open Circuit Leak Current vs. Supply Voltage**

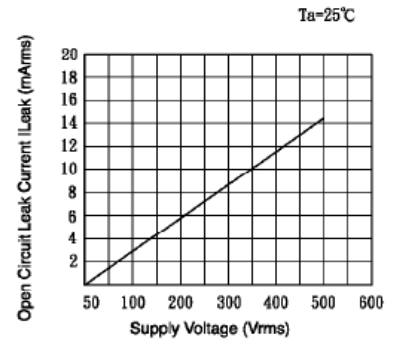

**Fig.4 RMS On-state Current vs. Case Temperature**

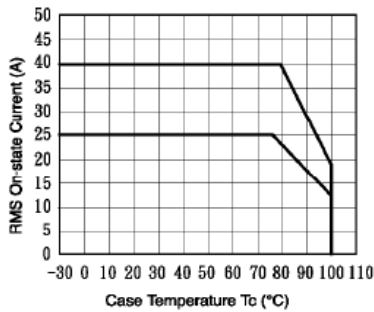

**Fig.5 Input Voltage vs. Ambient Temperature**

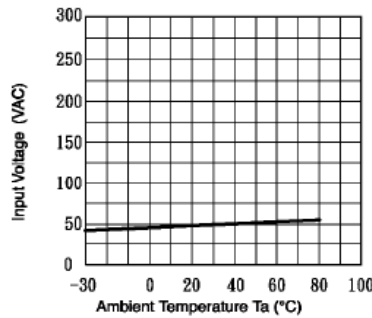

**Fig.6 Input Current vs. Input voltage**

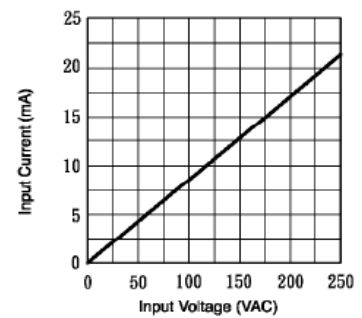

**Fig.7 Action waveform**

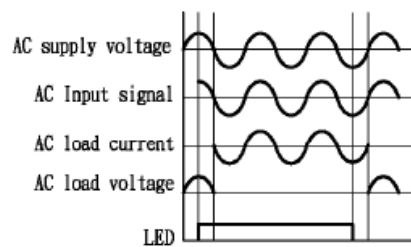

**Fig.8 WIRING DIAGRAM**

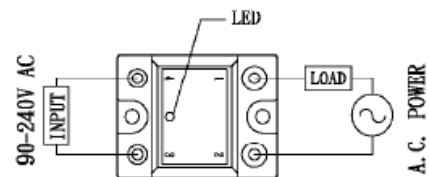

OPTeK reserves the right to make changes at any time in order to improve design and to supply the best product possible.

# Solid-State Relays

## Panel Mount Package—VAC Input / VAC Output

### OSSRA0007A thru OSSRA0012A



## OSSRA0012A

### Characteristic Data Curves

**Fig.1** RMS On-state Current vs. Ambient Temperature

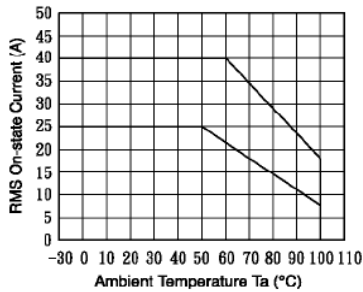

**Fig.2** Surge Current vs. Time

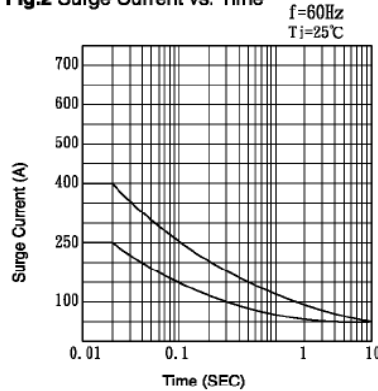

**Fig.3** Open Circuit Leak Current vs. Supply Voltage

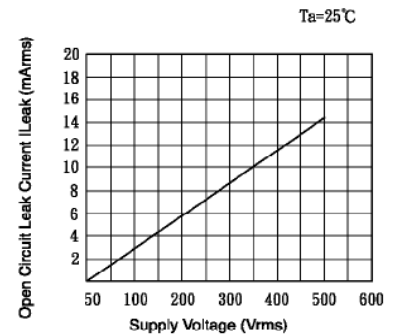

**Fig.4** RMS On-state Current vs. Case Temperature

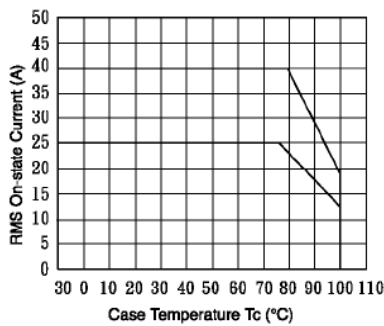

**Fig.5** Input Voltage vs. Ambient Temperature

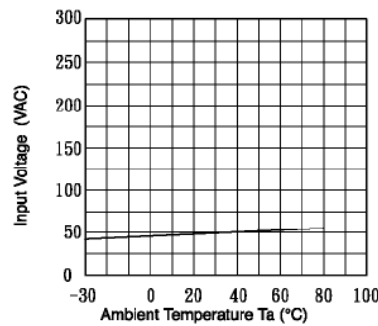

**Fig.6** Input Current vs. Input voltage

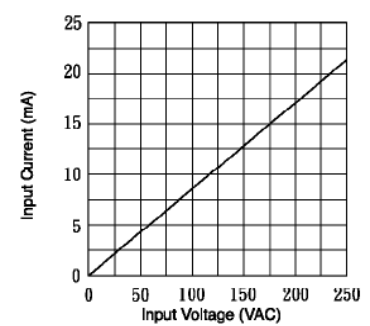

**Fig.7** Action waveform

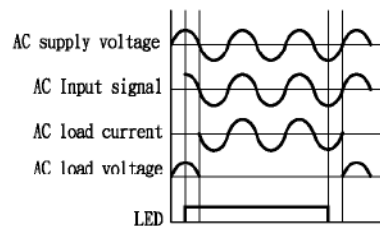

**Fig.8** WIRING DIAGRAM

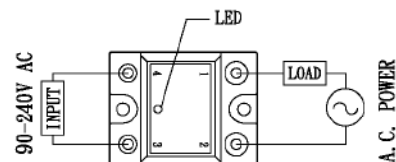

OPTEK reserves the right to make changes at any time in order to improve design and to supply the best product possible.



# Solid-State Relays

## Panel Mount Package—VAC Input / VAC Output

### OSSRA0007A thru OSSRA0012A



#### Quality and Reliability Requirements:

Parameter	Failure Criteria	Test Conditions
Room Temperature Operating Life (for light emitting diodes only)	± 20%	T <sub>A</sub> = 25°C, I <sub>F</sub> = 60mA or max. rated, Time = 1000 hours
High Humidity, High Temperature Reverse Bias	± 20%	JEDEC, Method A101-B T <sub>A</sub> = 85°C, Humidity = 85%RH, Time = 1000 hours,
High Temperature Forward Bias	± 20%	JEDEC, Method A108-A T <sub>A</sub> = 70°C, I <sub>F</sub> = 20mA, Time = 1000 hours
Autoclave	0 Fail	T <sub>A</sub> = 121°C, Pressure = 15psi, Humidity = 100%
IR Reflow / Solderability Test	0 Fail	JEDEC (J-STD-020) / MIL-STD-883E, Method 2003.7
MTTF @ 90% confidence	150,000 Min.	@ 25°C, 25mADC
Moisture Sensitivity Level	MSL 1	per JDEC stnd J-STD-020B
Glass Transition of body	125°C Min.	DSC test method
Temperature Humidity-Bias	± 20%	85°C, 85%RH, 500Hrs, 80% min Iceo
Temperature Cycle	± 20%	per Method 1010.7 of MIL-STD-883E
High Temperature Storage	± 20%	85°C, 500Hrs

#### Label Identification:

#### DESCRIPTION:

Size: 3" (7.4 cm) X 2.2" (5.5 cm)  
 Lettering shall be black on white background.  
 Format shall be as:

#### Notes:

- The DATE CODE is a 4-digit code for date of manufacture where YY is the last two digits of the year, and WW is week number of manufacture.
- The LOT I.D. is the manufacturing location lot identification where Y is the year of manufacture, NNNN is a sequential lot identifier, and DDD is the day of the year of manufacture. – or use equivalent label format.

 Carrollton, TX, USA MADE IN TAIWAN 
OPTEK P/N <u>  OSSRA0007A  </u> 
QTY. <u>  N/A  </u> 
DATE CODE <u>  (Y Y W W)  </u> 
LOT I.D. <u>  (Y - N N N N D D D)  </u> 

OPTEK reserves the right to make changes at any time in order to improve design and to supply the best product possible.

# Solid-State Relays

## Panel Mount Package—VAC Input / VAC Output

### OSSRA0007A thru OSSRA0012A



### Packaging Information:

Optek's Solid-State Relays Part Numbers (4-Pin SIP)		Packaging Quantities	Tubes		Inner		Medium Carton			Large Carton		
			Qty	Weight (g)	Qty	Weight (kg)	Qty	Net Weight (kg)	Gross Weight (kg)	Qty	Net Weight (kg)	Gross Weight (kg)
		Package Type	53.5 x 7.0 x 7.5 cm		55.5 x 30.7 x 16.5 cm			55.5 x 30.7 x 23.5 cm				
SSR	OSSRD2001D, OSSRD2002A	4 Pin SIP (24mm x 37mm)	10	213	80	1.80	640	14.4	15.4	960	21.6	22.9
	OSRRD1001A - OSSRD1006A	4 Pin SIP (32mm x 24mm)	20	421	80	1.90	640	15.2	16.2	960	22.8	24.1

  

Optek's Solid-State Relays Part Numbers (Panel Mounts)		Packaging Quantities	Trays		Small Carton			Medium Carton			Large Carton		
			Qty	Weight (g)	Qty	Net Weight (kg)	Gross Weight (kg)	Qty	Net Weight (kg)	Gross Weight (kg)	Qty	Net Weight (kg)	Gross Weight (kg)
		Package Type	36 x 20 x 37 cm		37 x 21 x 11 cm			37 x 21 x 17 cm			37 x 21 x 32 cm		
SSR	OSSRD0001A - OSSRD0006A OSSRA0007A - OSSRA0012A	Panel Mounts (42.5mm x 58mm)	10	920	30	2.80	3.3	50	4.7	5.4	100	9.5	10.5

### Tray and Carton Packaging Specifications:

#### Tray Packaging Dimensions

All dimensions in centimeters (mm)

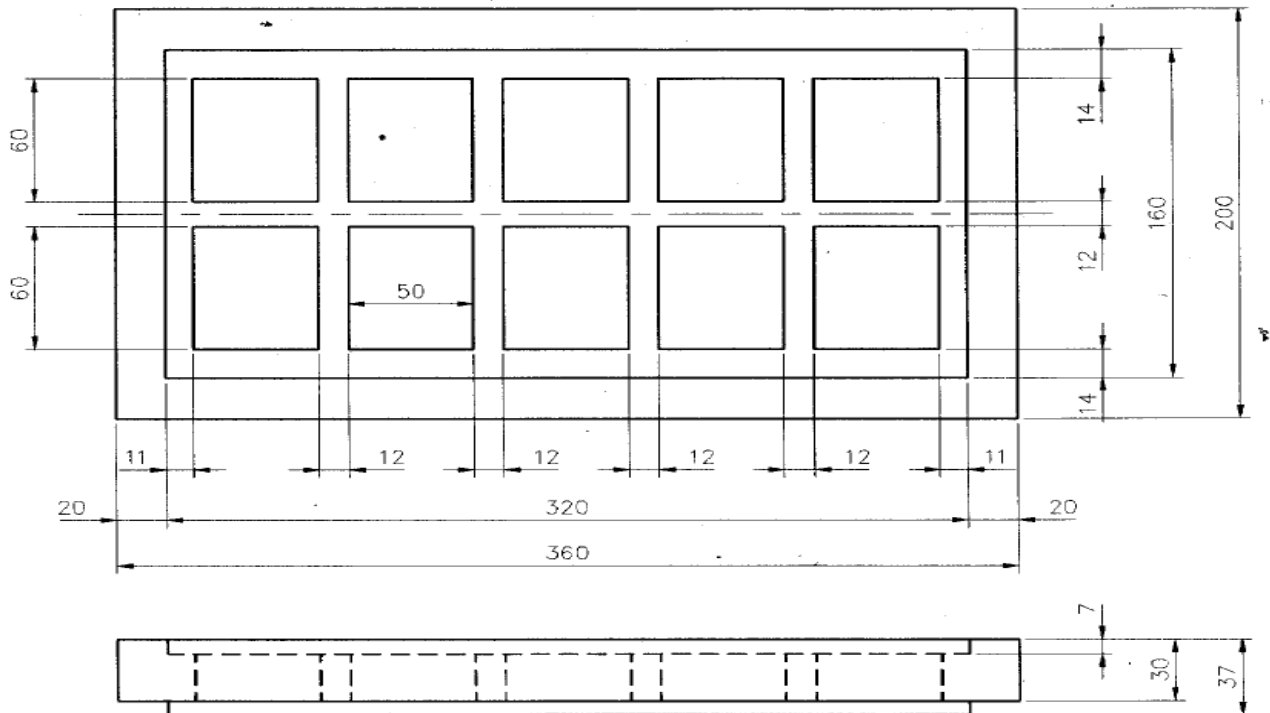

OPTEK reserves the right to make changes at any time in order to improve design and to supply the best product possible.

# Solid-State Relays

## Panel Mount Package—VAC Input / VAC Output

### OSSRA0007A thru OSSRA0012A



### Tray and Carton Packaging Specifications (Cont.):

#### Carton Packaging Dimensions

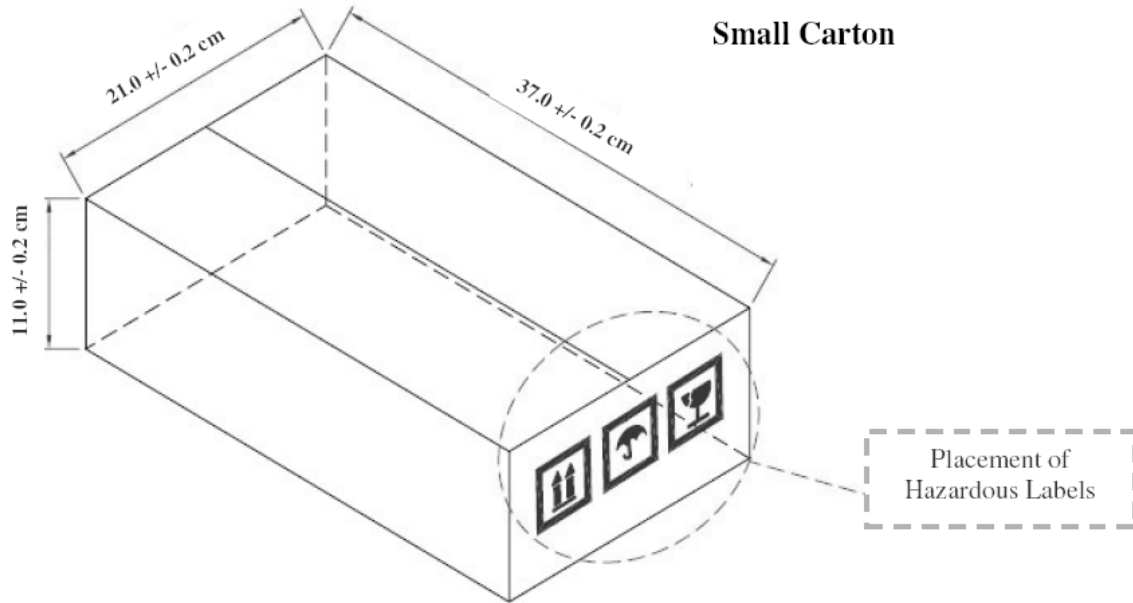

All dimensions in centimeters (cm)

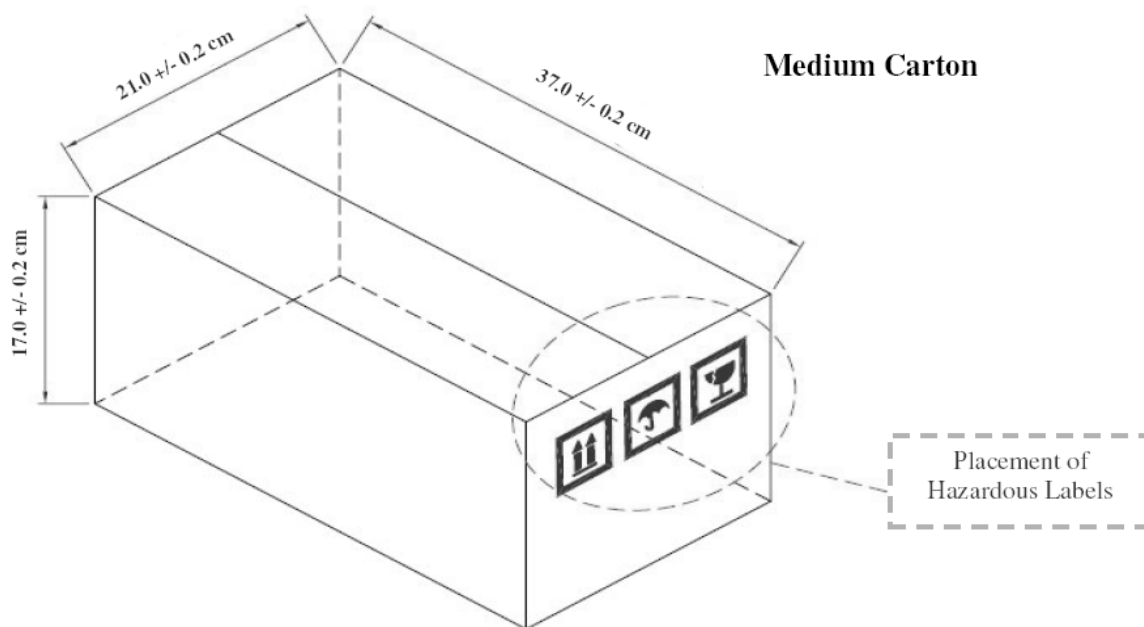

All dimensions in centimeters (cm)

OPTEK reserves the right to make changes at any time in order to improve design and to supply the best product possible.

# Solid-State Relays

## Panel Mount Package—VAC Input / VAC Output

### OSSRA0007A thru OSSRA0012A



### Tray and Carton Packaging Specifications (Cont.):

#### Carton Packaging Dimensions

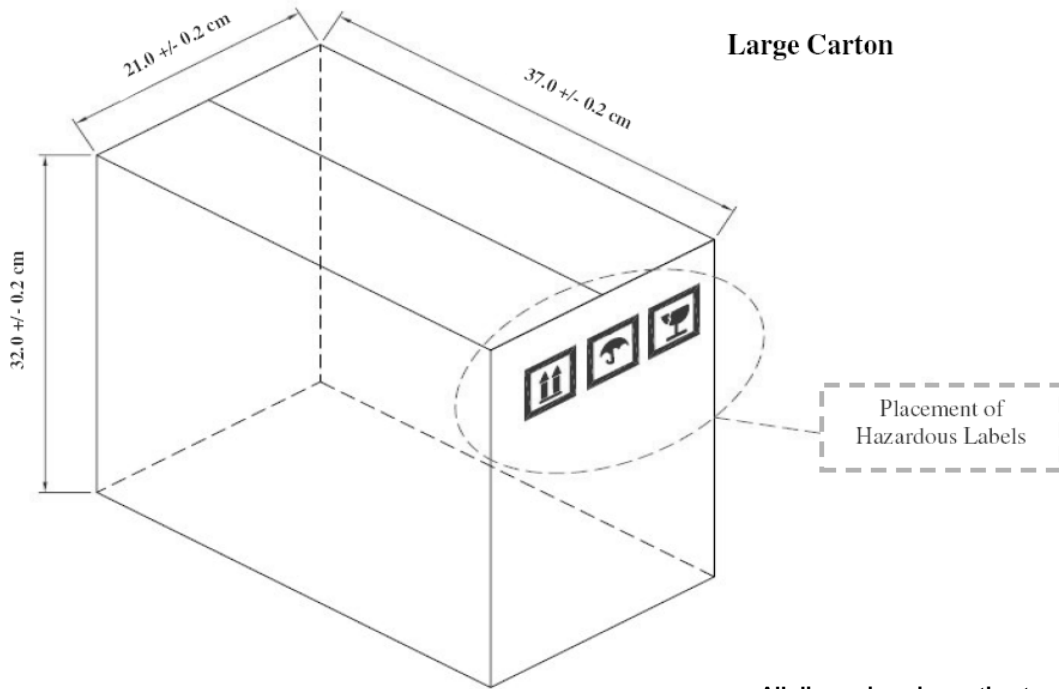

Large Carton

All dimensions in centimeters (cm)

OPTEK reserves the right to make changes at any time in order to improve design and to supply the best product possible.