



	LAA125L	Units
Blocking Voltage	350	V_P
Load Current	150	mA
Max R_{ON}	18	Ω

Features

- Small 8 Pin Packages
- Low Drive Power Requirements (TTL/CMOS Compatible)
- No Moving Parts
- High Reliability
- Arc-Free With No Snubbing Circuits
- 3750V_{RMS} Input/Output Isolation
- No EMI/RFI Generation
- Machine Insertable, Wave Solderable
- Surface Mount and Tape & Reel Versions Available
- Current Limiting
- Flammability classification rating: V-0

Applications

- Telecommunications
 - Telecom Switching
 - Tip/Ring Circuits
 - Modem Switching (Laptop, Notebook, Pocket Size)
- Hook Switch
- Dial Pulsing
- Ground Start
- Ringing Injection
- Instrumentation
 - Multiplexers
 - Data Acquisition
 - Electronic Switching
 - I/O Subsystems
 - Meters (Watt-Hour, Water, Gas)
 - Medical Equipment-Patient/Equipment Isolation
- Security
- Aerospace
- Industrial Controls

Description

LAA125L is a 350V, 150mA, 18 Ω dual 1-Form-A relay. It combines enhanced peak load current capability and current limiting with low on-resistance.

Approvals

- UL Recognized: File Number E76270
- CSA Certified: File Number LR 43639
- Certified to:
 - EN 60950
 - EN 41003

Ordering Information

Part #	Description
LAA125L	8 Pin DIP (50/Tube)
LAA125LS	8 Pin Surface Mount (50/Tube)
LAA125LSTR	8 Pin Surface Mount (1,000/Reel)
LAA125PL	8 Pin Flat Pack (50/Tube)
LAA125PLTR	8 Pin Flat Pack (1,000/Reel)

Pin Configuration

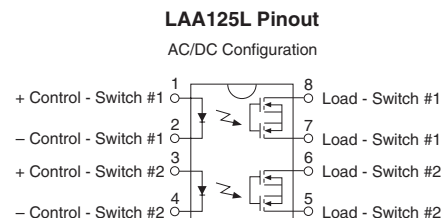

Switching Characteristics of Normally Open (Form A) Devices

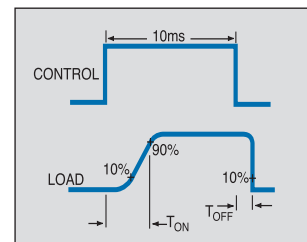

Absolute Maximum Ratings (@ 25° C)

Parameter	Ratings	Units
Blocking Voltage	350	V _p
Reverse Input Voltage	5	V
Input Control Current	50	mA
Peak (10ms)	1	A
Input Power Dissipation ¹	150	mW
Total Power Dissipation ²	800	mW
Isolation Voltage Input to Output	3750	V _{rms}
Operational Temperature	-40 to +85	°C
Storage Temperature	-40 to +125	°C

¹ Derate Linearly 1.33 mw/°C

² Derate Linearly 6.67 mw/°C

Absolute Maximum Ratings are stress ratings. Stresses in excess of these ratings can cause permanent damage to the device. Functional operation of the device at conditions beyond those indicated in the operational sections of this data sheet is not implied.

Electrical Characteristics

Parameter	Conditions	Symbol	Min	Typ	Max	Units
Output Characteristics @ 25°C						
Load Current	Continuous	I _L	-	-	150	mA
Peak Load Current	10ms max	I _{LPK}	-	-	400	mA
Load Current Limiting		I _{CL}	190	235	280	mA
On-Resistance	I _L =Load Current	R _{ON}	-	-	18	Ω
Off-State Leakage Current	V _L =350V	I _{LEAK}	-	-	1	μA
Switching Speeds						
Turn-On	I _F =5mA, V _L =10V	T _{ON}	-	-	5	ms
Turn-Off	I _F =5mA, V _L =10V	T _{OFF}	-	-	5	ms
Output Capacitance	50V; f=1MHz	C _{OUT}	-	50	-	pF
Input Characteristics @ 25°C						
Input Control Current	I _L =170mA	I _F	5	-	-	mA
Input Dropout Current	-	-	0.4	0.7	-	mA
Input Voltage Drop	I _F =5mA	V _F	0.9	1.2	1.4	V
Reverse Input Current	V _R =5V	I _R	-	-	10	μA
Input to Output Capacitance	-	C _{I/O}	-	3	-	pF

PERFORMANCE DATA*

LAA125L
Typical LED Forward Voltage Drop
(N=50 Ambient Temperature = 25°C)
 $I_F = 5\text{mA}_{DC}$

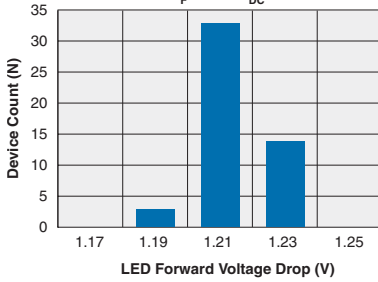

LAA125L
Typical On-Resistance Distribution
(N=50 Ambient Temperature = 25°C)
(Load Current = 150mA_{DC})

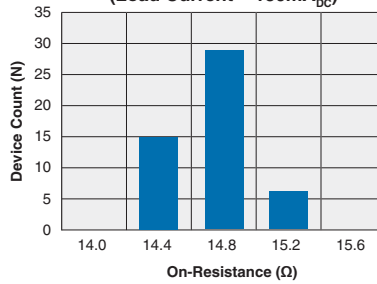

LAA125L
Typical Blocking Voltage Distribution
(N=50 Ambient Temperature = 25°C)

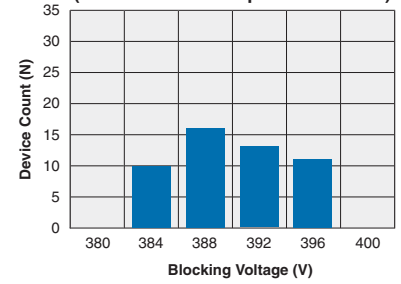

LAA125L
Typical I_F for Switch Operation
(N=50 Ambient Temperature = 25°C)
(Load Current = 150mA_{DC})

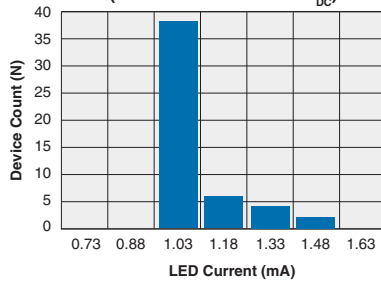

LAA125L
Typical I_F for Switch Dropout
(N=50 Ambient Temperature = 25°C)
(Load Current = 150mA_{DC})

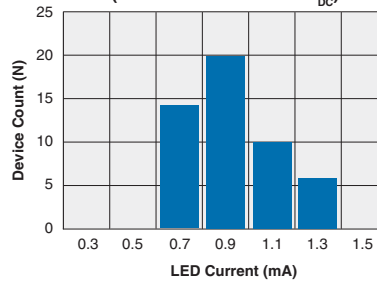

LAA125L
Typical Turn-On Time
(N=50 Ambient Temperature = 25°C)
(Load Current = 150mA_{DC}; $I_F = 5\text{mA}_{DC}$)

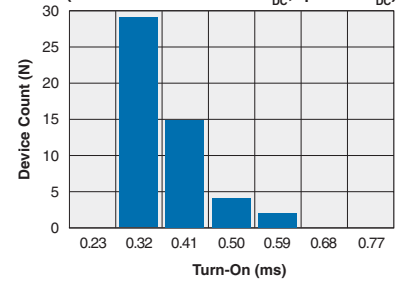

LAA125L
Typical Turn-Off Time
(N=50 Ambient Temperature = 25°C)
(Load Current = 150mA_{DC}; $I_F = 5\text{mA}_{DC}$)

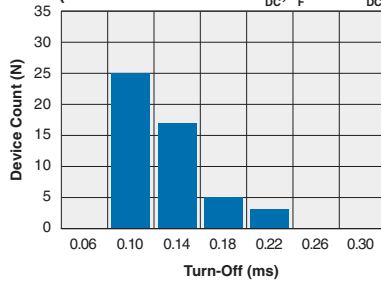

LAA125L
Typical Load Current vs. Temperature

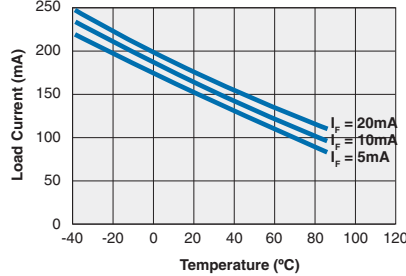

LAA125L
Typical Leakage vs. Temperature
(Measured across Pins 5 & 6 or 7 & 8)

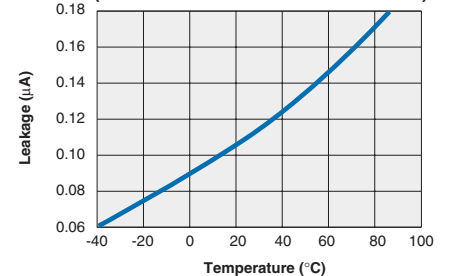

LAA125L
Typical Blocking Voltage vs. Temperature

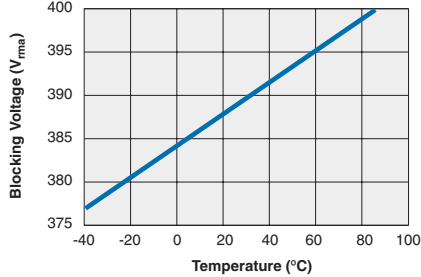

LAA125L
Typical Turn-On vs. Temperature
(Load Current = 150mA_{DC})

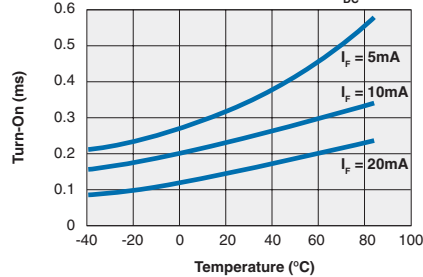

LAA125L
Typical Turn-Off vs. Temperature
(Load Current = 150mA_{DC})

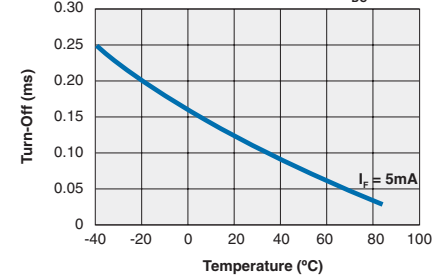

*The Performance data shown in the graphs above is typical of device performance. For guaranteed parameters not indicated in the written specifications, please contact our application department.

PERFORMANCE DATA*

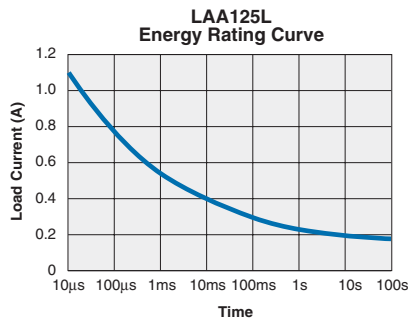
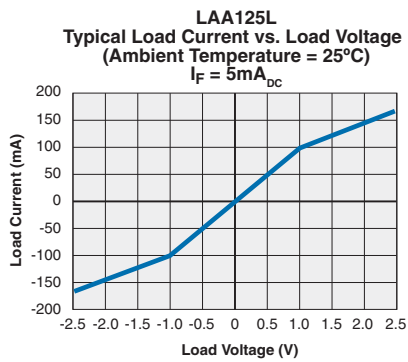
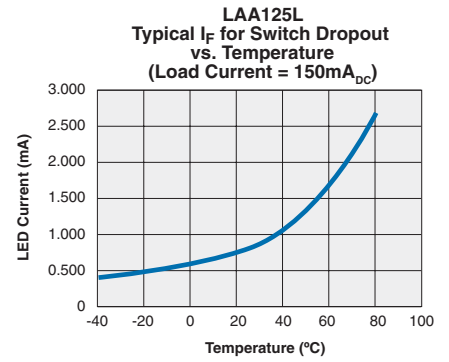
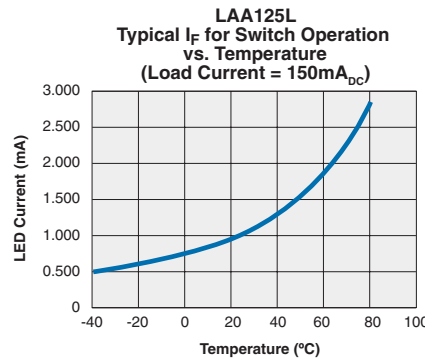
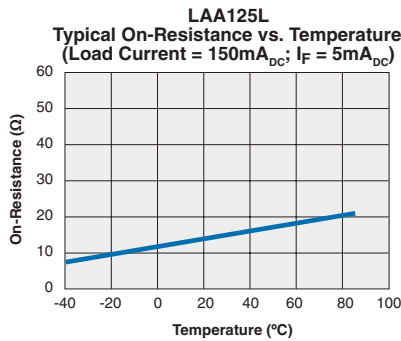
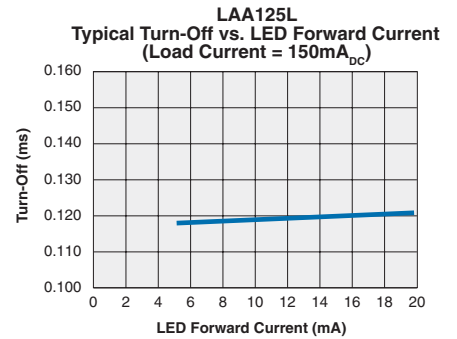
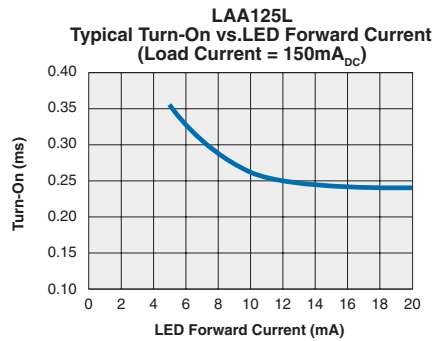
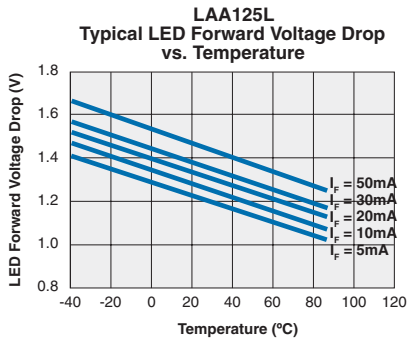

*The Performance data shown in the graphs above is typical of device performance. For guaranteed parameters not indicated in the written specifications, please contact our application department.

Manufacturing Information

Soldering

Recommended soldering processes are limited to 245°C component body temperature for 10 seconds.

Washing

Clare does not recommend ultrasonic cleaning or the use of chlorinated solvents.

MECHANICAL DIMENSIONS

8 Pin DIP Through Hole (Standard)

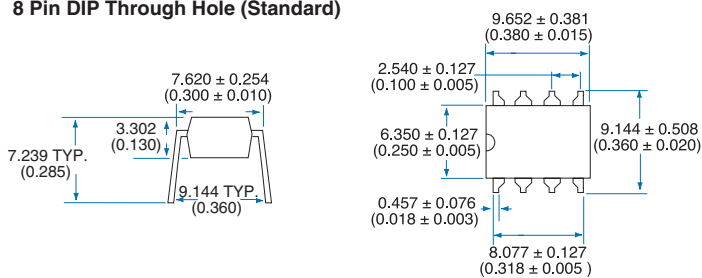

PC Board Pattern (Top View)

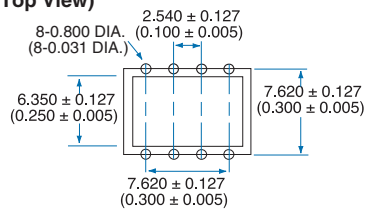

8 Pin Surface Mount ("S" Suffix)

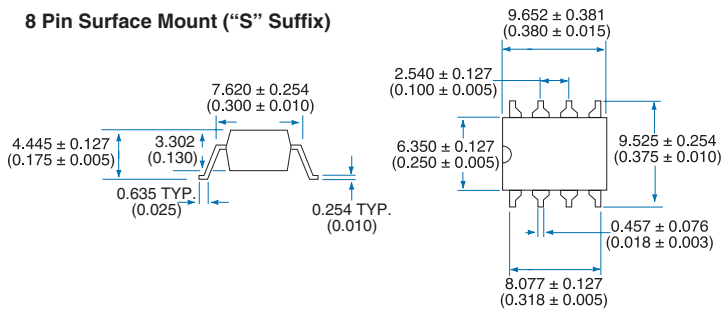

PC Board Pattern (Top View)

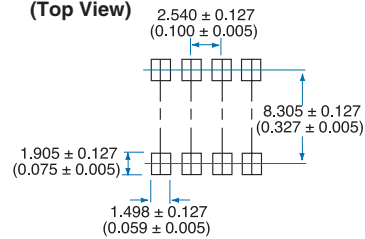

8 Pin Flatpack ("P" Suffix)

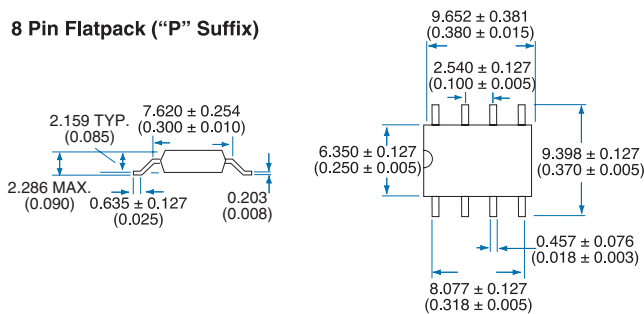

PC Board Pattern (Top View)

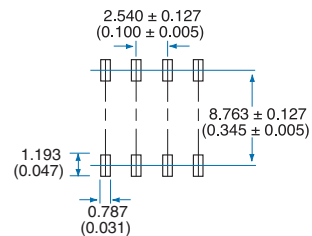

Dimensions
mm
(inches)

MECHANICAL DIMENSIONS

Tape and Reel Packaging for 8 Pin Surface Mount Package

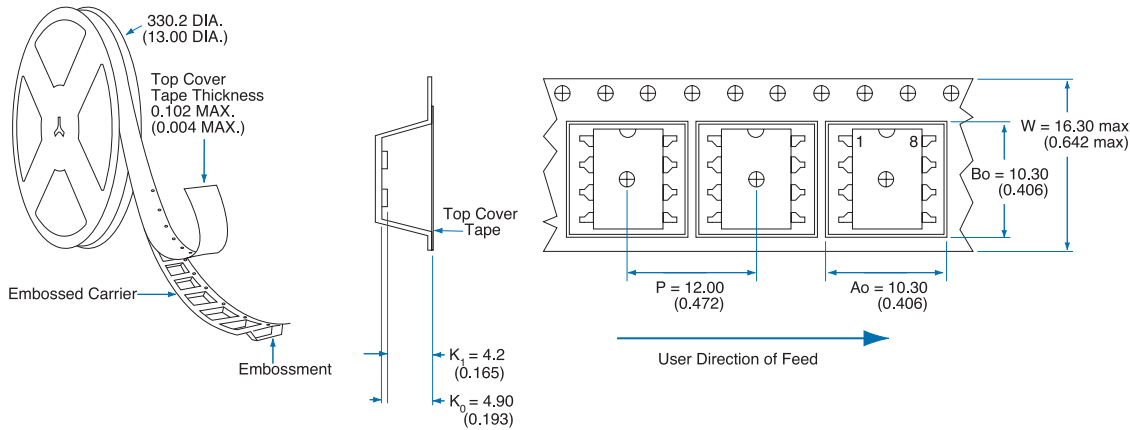

Tape and Reel Packaging for 8 Pin Flatpack Package

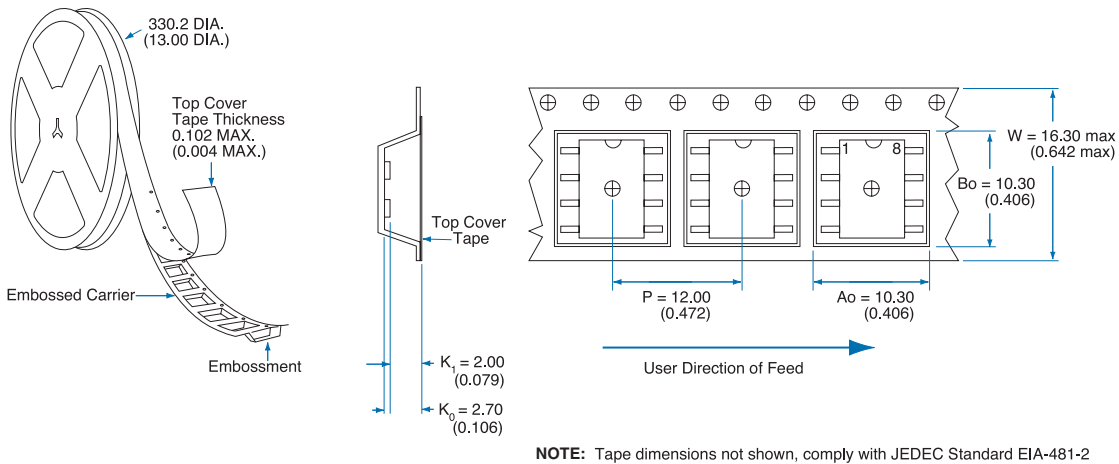

Dimensions
mm
(inches)

For additional information please visit our website at: www.clare.com

Clare, Inc. makes no representations or warranties with respect to the accuracy or completeness of the contents of this publication and reserves the right to make changes to specifications and product descriptions at any time without notice. Neither circuit patent licenses nor indemnity are expressed or implied. Except as set forth in Clare's Standard Terms and Conditions of Sale, Clare, Inc. assumes no liability whatsoever, and disclaims any express or implied warranty, relating to its products including, but not limited to, the implied warranty of merchantability, fitness for a particular purpose, or infringement of any intellectual property right.

The products described in this document are not designed, intended, authorized or warranted for use as components in systems intended for surgical implant into the body, or in other applications intended to support or sustain life, or where malfunction of Clare's product may result in direct physical harm, injury, or death to a person or severe property or environmental damage. Clare, Inc. reserves the right to discontinue or make changes to its products at any time without notice.

Specification: DS-LAA125L-R10
©Copyright 2005, Clare, Inc.
OptoMOS® is a registered trademark of Clare, Inc.
All rights reserved. Printed in USA.
2/23/05