



Parameter	Rating	Units
Maximum Turn-On/Turn-Off Times	50	μs
Blocking Voltage	300	V <sub>p</sub>
Load Current	50	mA
Max On-resistance	100	Ω

### Features

- Fastest Switching OptoMOS Relay, 50μs
- Small 6-Pin DIP Package
- Low Drive Power Requirements (TTL/CMOS Compatible)
- No Moving Parts
- High Reliability
- Arc-Free With No Snubbing Circuits
- 3750V<sub>rms</sub> Input/Output Isolation
- FCC Compatible
- No EMI/RFI Generation
- Machine Insertable, Wave Solderable
- Surface Mount Tape & Reel Version Available
- Flammability Classification Rating of V-0

### Applications

- Instrumentation
  - Multiplexers
  - Data Acquisition
  - Electronic Switching
  - I/O Subsystems
  - Meters (Watt-Hour, Water, Gas)
- Medical Equipment—Patient/Equipment Isolation
- Security Systems
- Aerospace
- Industrial Controls
- Reed Relay Replacement

### Description

PLA160 is a 300V, 50mA, 100Ω 1-Form-A relay. This performance leader features the fastest switching speed (50μs) available in an OptoMOS relay.

### Approvals

- UL Recognized Component: File # E76270
- CSA Certified Component: Certificate # 1175739
- EN/IEC 60950 Compliant

### Ordering Information

Part Number	Description
PLA160	6-Pin DIP (50/Tube)
PLA160S	6-Pin Surface Mount (50/Tube)
PLA160STR	6-Pin Surface Mount (1,000/Reel)

### Pin Configuration

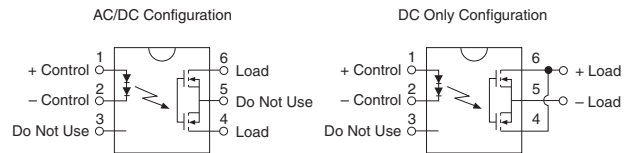

### Switching Characteristics of Normally Open (Form A) Devices

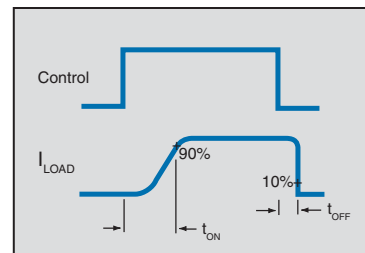

## Absolute Maximum Ratings

Parameter	Ratings	Units
Blocking Voltage	300	$V_P$
Reverse Input Voltage	5	V
Input Control Current	50	mA
Peak (10ms)	1	A
Input Power Dissipation <sup>1</sup>	150	mW
Total Power Dissipation <sup>2</sup>	800	mW
Isolation Voltage, Input to Output	3750	$V_{rms}$
Operational Temperature	-40 to +85	°C
Storage Temperature	-40 to +125	°C

<sup>1</sup> Derate Linearly 1.33 mW/°C

<sup>2</sup> Derate Linearly 6.67 mW/°C

Electrical absolute maximum ratings are at 25°C

*Absolute Maximum Ratings are stress ratings. Stresses in excess of these ratings can cause permanent damage to the device. Functional operation of the device at conditions beyond those indicated in the operational sections of this data sheet is not implied.*

## Electrical Characteristics

Parameter	Conditions	Symbol	Min	Typ	Max	Units
<b>Output Characteristics @ 25°C</b>						
Load Current (Continuous)						
AC/DC Configuration	-	$I_L$	-	-	50	mA
DC Configuration			-	-	80	
Peak Load Current	t=10ms	$I_{LPK}$	-	-	200	mA
On-Resistance						
AC/DC Configuration	$I_F=50mA$	$R_{ON}$	-	60	100	$\Omega$
DC Configuration	$I_F=80mA$		-	15	30	
Off-State Leakage Current						
	$V_L=300V$	$I_{LEAK}$	-	-	25	nA
	$V_L=100V$		-	1	10	
Switching Speeds						
Turn-On	$I_F=10mA, V_L=10V$	$t_{ON}$	-	25	50	$\mu s$
Turn-Off		$t_{OFF}$		42		
Output Capacitance	50V, f=1mHz	$C_{OUT}$	-	3	-	pF
<b>Input Characteristics @ 25°C</b>						
Input Control Current	$I_L=50mA$	$I_F$	-	1.35	10	mA
Input Dropout Current	-	$I_F$	0.4	1.25	-	mA
Input Voltage Drop	$I_F=10mA$	$V_F$	1.8	2.4	2.8	V
Reverse Input Current	$V_R=5V$	$I_R$	-	-	10	$\mu A$
<b>Common Characteristics @ 25°C</b>						
Input to Output Capacitance	-	$C_{I/O}$	-	3	-	pF

**PERFORMANCE DATA\***

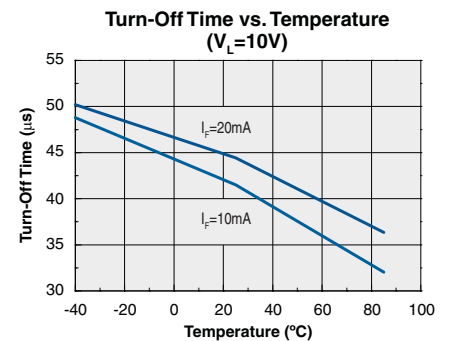
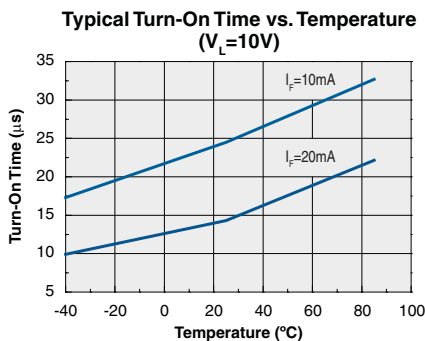
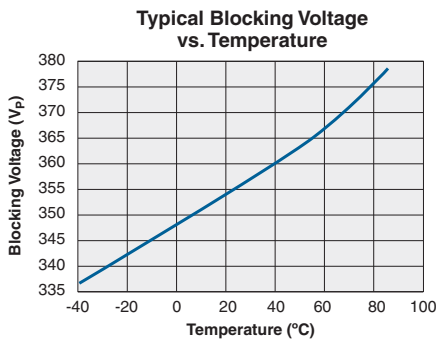
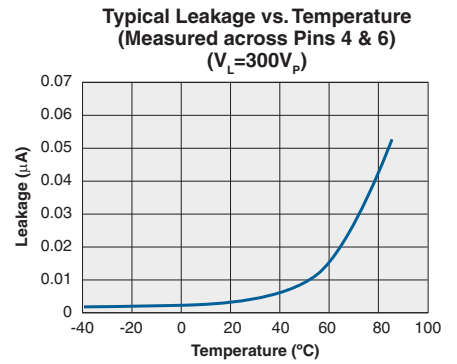
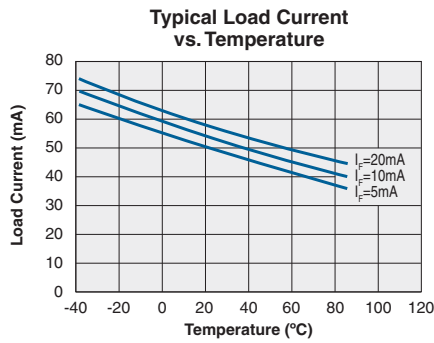
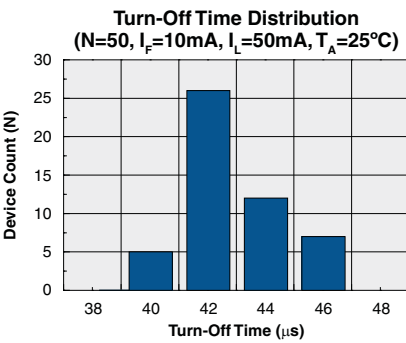
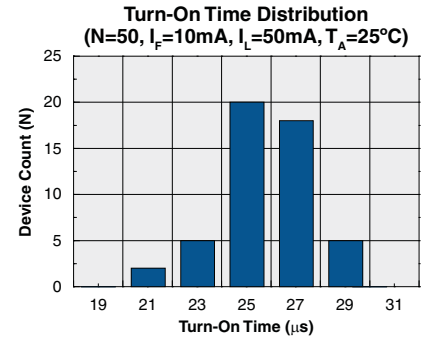
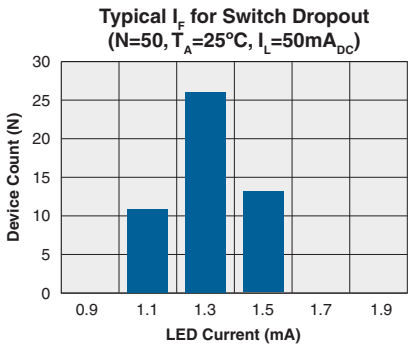
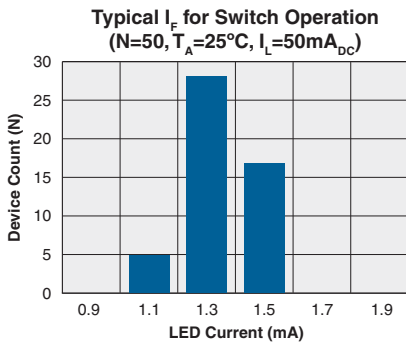
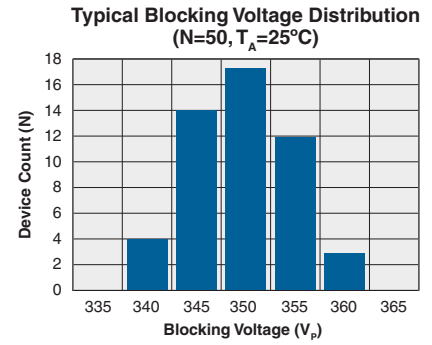
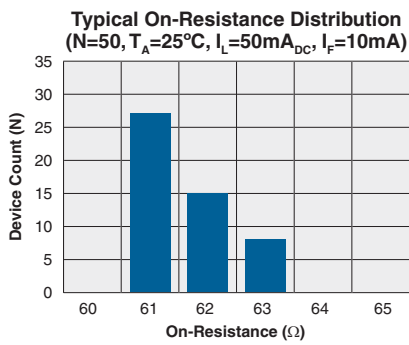
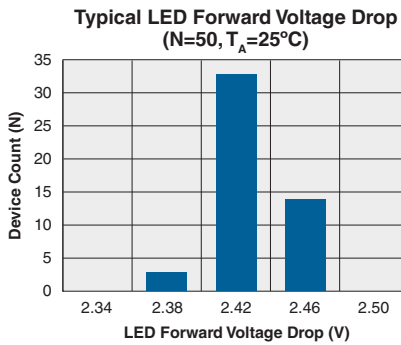

\*The Performance data shown in the graphs above is typical of device performance. For guaranteed parameters not indicated in the written specifications, please contact our application department.

PERFORMANCE DATA\*

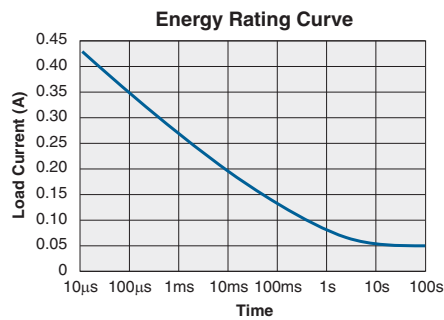
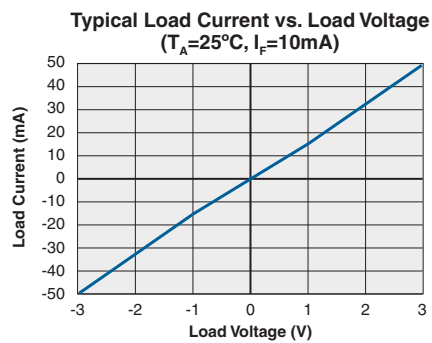
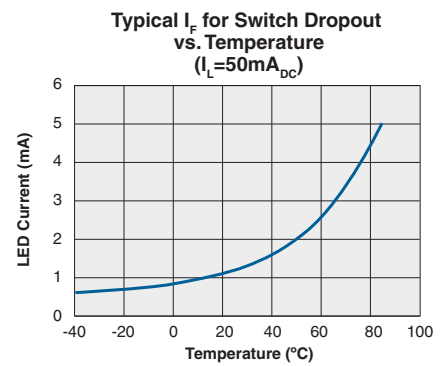
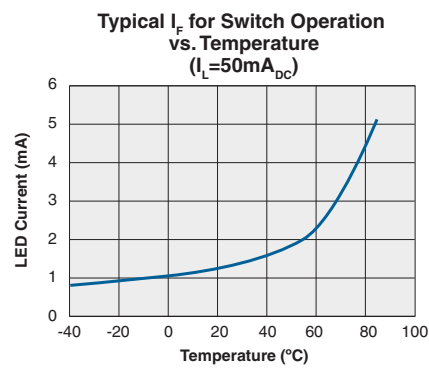
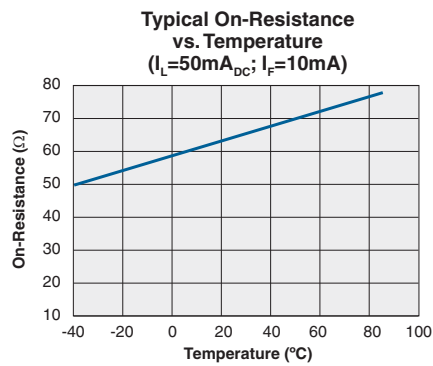
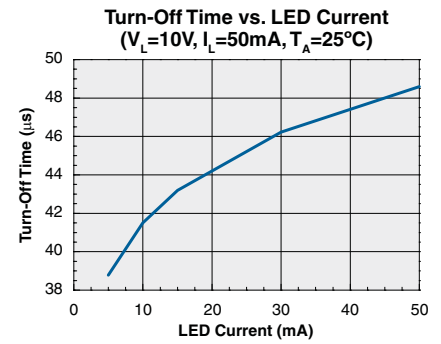
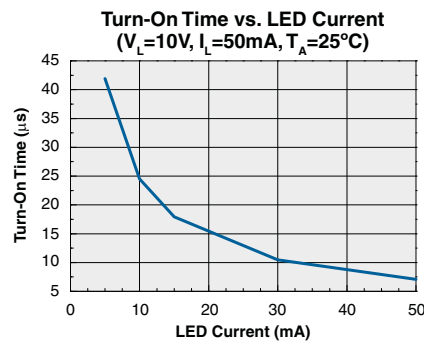
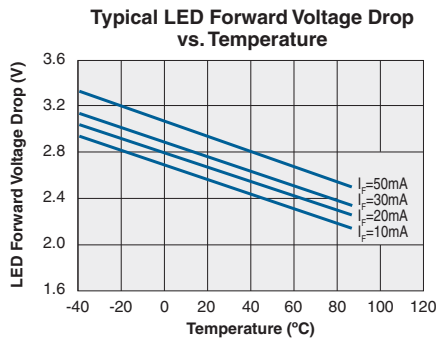

\*The Performance data shown in the graphs above is typical of device performance. For guaranteed parameters not indicated in the written specifications, please contact our application department.

**Manufacturing Information**

**Soldering**

For proper assembly, the component must be processed in accordance with the current revision of IPC/JEDEC standard J-STD-020. Failure to follow the recommended guidelines may cause permanent damage to the device resulting in impaired performance and/or a reduced lifetime expectancy.

**Washing**

Clare does not recommend ultrasonic cleaning or the use of chlorinated solvents.



**MECHANICAL DIMENSIONS**

**6-Pin DIP Thru-Hole Package**

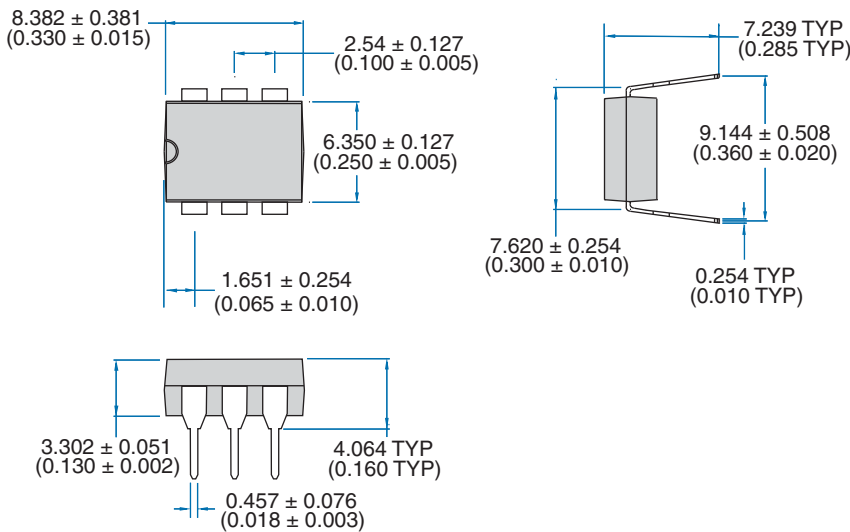

**PC Board Pattern**

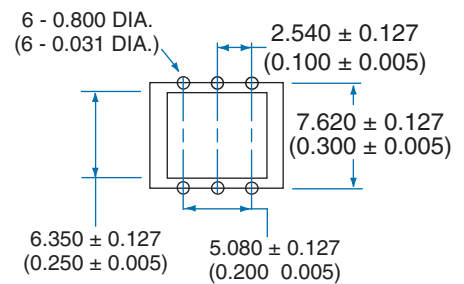

Dimensions  
mm  
(inches)

**6-Pin Surface Mount Package ("S" Suffix)**

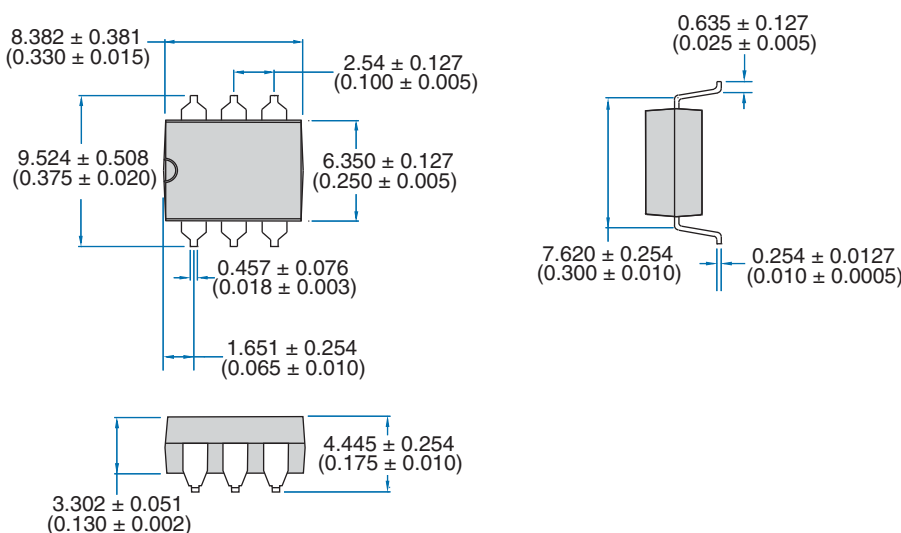

**Recommended PCB Land Pattern**

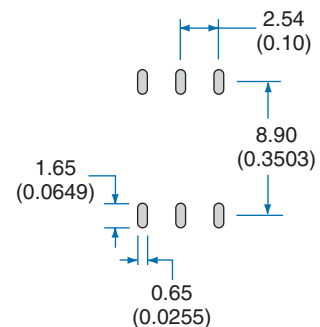

Dimensions  
mm  
(inches)

**Tape and Reel Packaging for 6-Pin “S” Suffix Parts**

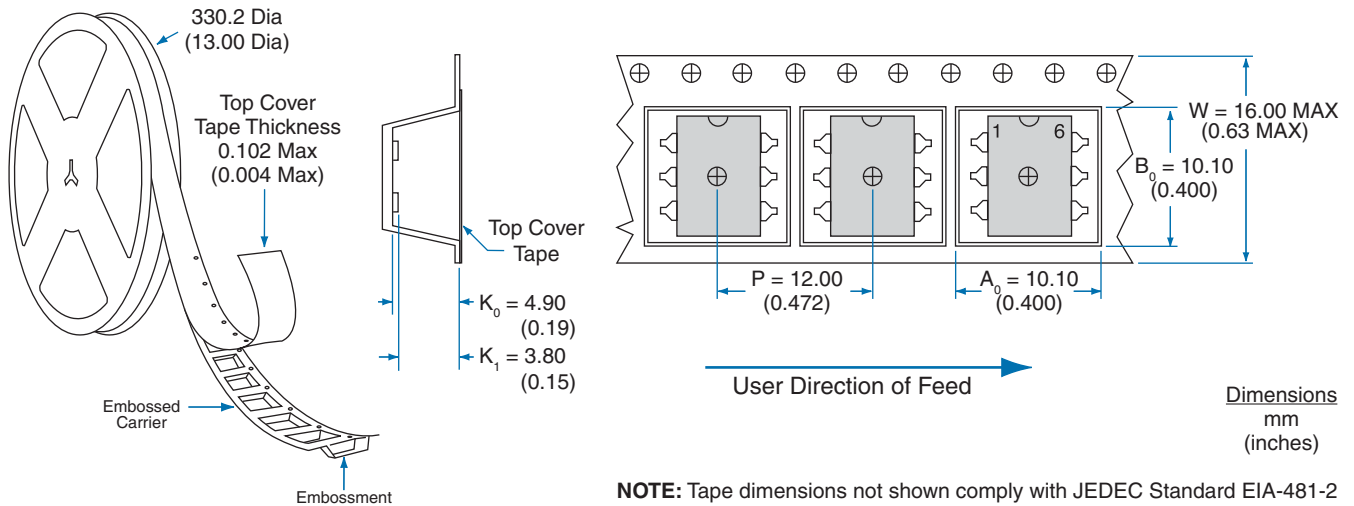

**For additional information please visit our website at: [www.clare.com](http://www.clare.com)**

Clare, Inc. makes no representations or warranties with respect to the accuracy or completeness of the contents of this publication and reserves the right to make changes to specifications and product descriptions at any time without notice. Neither circuit patent licenses nor indemnity are expressed or implied. Except as set forth in Clare's Standard Terms and Conditions of Sale, Clare, Inc. assumes no liability whatsoever, and disclaims any express or implied warranty, relating to its products including, but not limited to, the implied warranty of merchantability, fitness for a particular purpose, or infringement of any intellectual property right.

The products described in this document are not designed, intended, authorized or warranted for use as components in systems intended for surgical implant into the body, or in other applications intended to support or sustain life, or where malfunction of Clare's product may result in direct physical harm, injury, or death to a person or severe property or environmental damage. Clare, Inc. reserves the right to discontinue or make changes to its products at any time without notice.