



Parameter	Rating	Units
Blocking Voltage	400	V_p
Load Current	500	mA_{rms}
On State Voltage Drop	1.4	V_{rms} (at $I_L = 500mA_{rms}$)

Features

- Load Current up to $0.5A_{rms}$
- $400V_p$ Blocking Voltage
- 5mA Sensitivity
- Zero-Crossing Detection
- DC Control, AC Output
- Optically Isolated
- TTL and CMOS Compatible
- Low EMI and RFI Generation
- High Noise Immunity
- Machine Insertable, Wave Solderable
- Flammability classification rating of V-0

Applications

- Programmable Control
- Process Control
- Power Control Panels
- Remote Switching
- Gas Pump Electronics
- Contactors
- Large Relays
- Solenoids
- Motors
- Heaters

Description

The CPC1943 is an AC Solid State Switch using optical coupling with dual power SCR outputs to produce an alternative to optocoupler and Triac circuits. The CPC1943 switches are robust enough to provide a blocking voltage of up to $400V_p$. In addition, tightly controlled zero cross circuitry ensures switching of AC loads without the generation of transients. The input and output circuits are optically coupled to provide $3750V_{rms}$ of isolation and noise immunity between control and load circuits. As a result the CPC1943 is well suited for industrial environments where electromagnetic interference could disrupt the operation of electromechanical relays.

Approvals

- UL 508 Certified Component: File E69938
- CSA Certified Component: Certificate 1172007

Ordering Information

Part #	Description
CPC1943G	6-Pin Dip (50/Tube)
CPC1943GS	6-Pin Surface Mount (50/Tube)
CPC1943GSTR	6-Pin Surface Mount (1000/Reel)

Pin Configuration

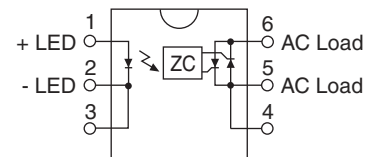

Absolute Maximum Ratings @ 25°C

Parameter	Ratings	Units
Blocking Voltage	400	V _P
Reverse Input Voltage	5	V
Input Control Current Peak (10ms)	100	mA
	1	A
Input Power Dissipation ¹	150	mW
P _{MAX} , Total Package Dissipation ²	800	mW
Isolation Voltage, Input to Output	3750	V _{rms}
Operational Temperature	-40 to +85	°C
Storage Temperature	-40 to +125	°C

Absolute Maximum Ratings are stress ratings. Stresses in excess of these ratings can cause permanent damage to the device. Functional operation of the device at conditions beyond those indicated in the operational sections of this data sheet is not implied.

¹ Derate linearly 1.33 mW / °C

² Derate linearly 6.67 mW / °C

Electrical Characteristics @ 25°C

Parameters	Conditions	Symbol	Min	Typ	Max	Units				
Output Characteristics										
Operating Voltage Range	V _L	-	20	-	120	V _{rms}				
Load Current, Continuous	V _L =120-240V _{rms}	I _L	0.005	-	0.5	A _{rms}				
Off State Leakage Current	V _L =400V _P	I _{LEAK}	-	-	1	mA				
On-State Voltage Drop	I _L =500mA _{rms}	V _{ON}	-	-	1.4	V _{rms}				
Critical Rate of Rise ³	-	dV/dt	1000	-	-	V/μs				
Switching Speeds	I _F =5 mA					cycles				
Turn-on							t _{on}	-	-	0.5
Turn-off							t _{off}	-	-	0.5
Zero-Cross Turn-On Voltage	1st half cycle	-	-	2	10	V				
	Subsequent half cycle	-	-	1	-	V				
Operating Frequency ¹	-		20	-	500	Hz				
Load Power Factor for Guaranteed Turn-On ²	-	PF	0.25	-	-	-				
Input Characteristics										
Input Control Current ⁴	-	I _F	-	0.8	5	mA				
Input Voltage Drop	I _F =5mA	V _F	0.9	1.2	1.4	V				
Input Drop-out Voltage	-		0.8	-	-	V				
Reverse Input Current	V _R =5V	I _R	-	-	10	μA				
Common Characteristics										
Input to Output Capacitance	-	C _{I/O}	-	3	-	pF				

¹ Zero Cross 1st half cycle @ <100Hz

² Snubber circuits may be required at low power factors.

³ Tested in accordance with EIA/NARM standard RS-443.

⁴ For high noise environments, use I_F=10mA.

PERFORMANCE DATA*

Typical LED Forward Voltage Drop
($T_A=25^\circ\text{C}$, $I_F=5\text{mA}$)

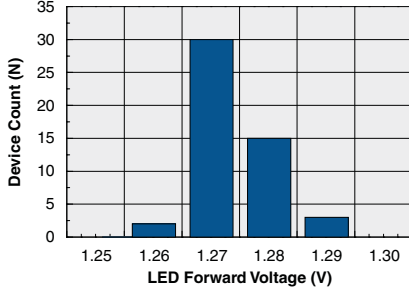

Typical On-State Voltage Distribution
($T_A=25^\circ\text{C}$, $I_L=500\text{mA}_{\text{rms}}$)

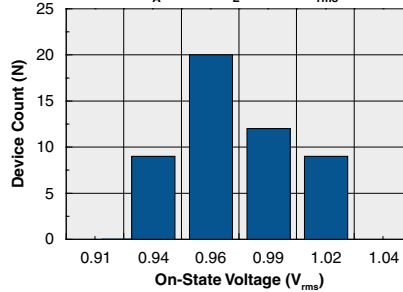

Typical Blocking Voltage Distribution
($T_A=25^\circ\text{C}$)

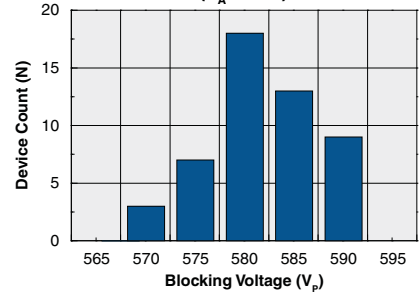

Typical I_F for Switch Operation
($T_A=25^\circ\text{C}$, $I_L=500\text{mA}_{\text{rms}}$)

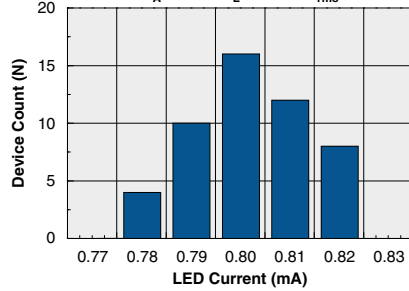

Typical I_F for Switch Operation vs. Temperature
($I_L=250\text{mA}_{\text{rms}}$)

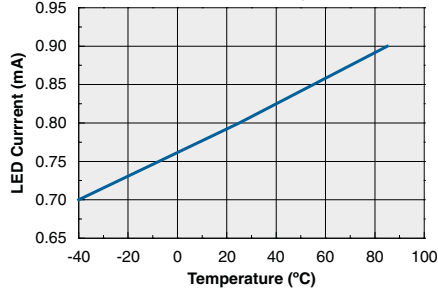

Typical Leakage Current vs. Temperature
($V_L=400\text{V}_p$)

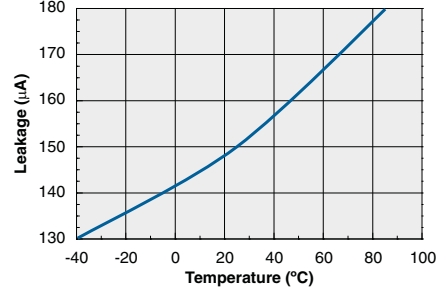

Typical Blocking Voltage vs. Temperature

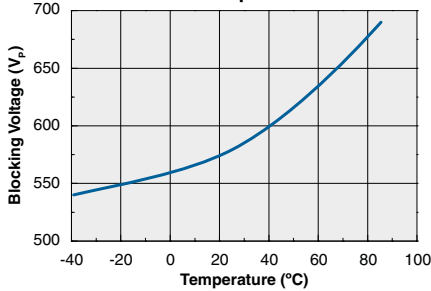

Typical On-State Voltage vs. Temperature
($I_L=250\text{mA}_{\text{rms}}$)

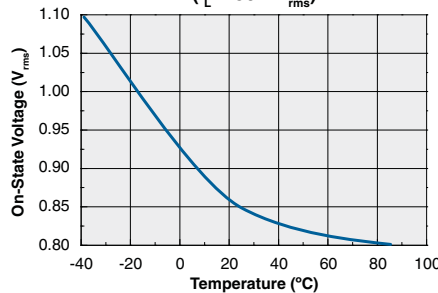

Typical LED Forward Voltage Drop vs. Temperature

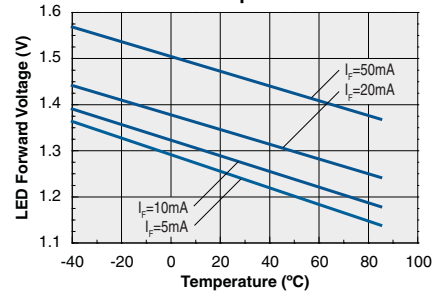

Load Current, Free Air vs. Temperature

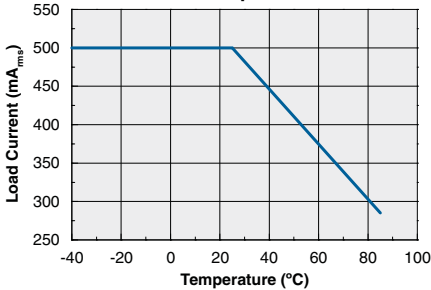

Typical dV/dt vs. Temperature

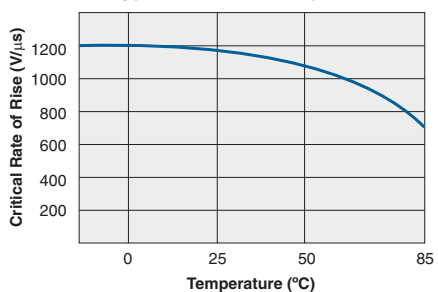

dV/dt Method

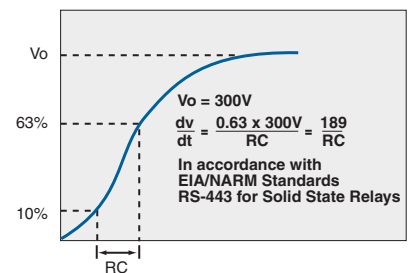

*The Performance data shown in the graphs above is typical of device performance. For guaranteed parameters not indicated in the written specifications, please contact our application department.

Manufacturing Information

Moisture Sensitivity



All plastic encapsulated semiconductor packages are susceptible to moisture ingress. Clare classified all of its plastic encapsulated devices for moisture sensitivity according to the latest version of the joint industry standard, **IPC/JEDEC J-STD-020**, in force at the time of product evaluation. We test all of our products to the maximum conditions set forth in the standard, and guarantee proper operation of our devices when handled according to the limitations and information in that standard as well as to any limitations set forth in the information or standards referenced below.

Failure to adhere to the warnings or limitations as established by the listed specifications could result in reduced product performance, reduction of operable life, and/or reduction of overall reliability.

This product carries a **Moisture Sensitivity Level (MSL) rating** as shown below, and should be handled according to the requirements of the latest version of the joint industry standard **IPC/JEDEC J-STD-033**.

Device	Moisture Sensitivity Level (MSL) Rating
CPC1943G / CPC1943GS	MSL 1

ESD Sensitivity



This product is **ESD Sensitive**, and should be handled according to the industry standard **JESD-625**.

Reflow Profile

This product has a maximum body temperature and time rating as shown below. All other guidelines of **J-STD-020** must be observed.

Device	Maximum Temperature x Time
CPC1943G / CPC1943GS	250°C for 30 seconds

Board Wash

Clare recommends the use of no-clean flux formulations. However, board washing to remove flux residue is acceptable. Since Clare employs the use of silicone coating as an optical waveguide in many of its optically isolated products, the use of a short drying bake could be necessary if a wash is used after solder reflow processes. Chlorine- or Fluorine-based solvents or fluxes should not be used. Cleaning methods that employ ultrasonic energy should not be used.



MECHANICAL DIMENSIONS

CPC1943G

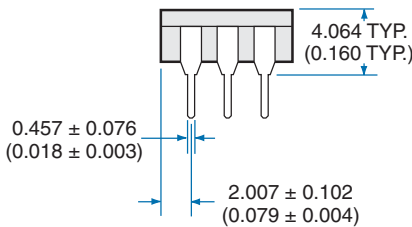
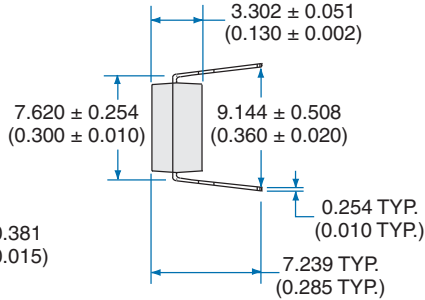
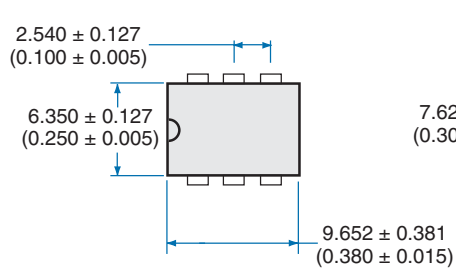

PCB Hole Pattern

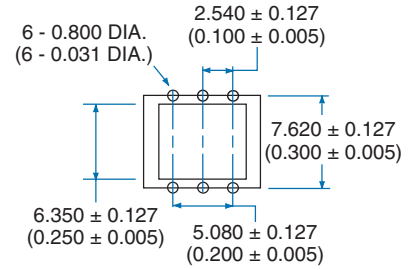

Dimensions
mm
(inches)

CPC1943GS

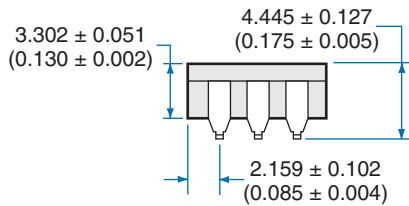
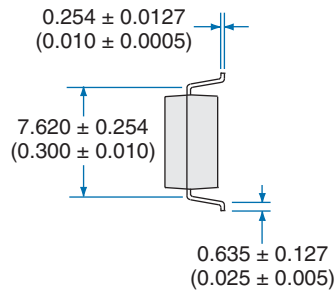
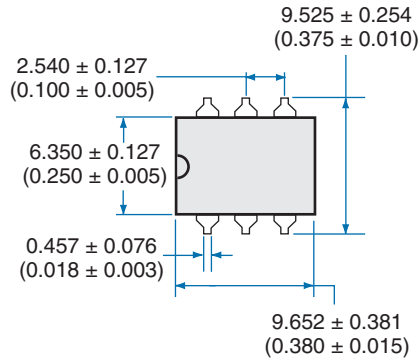

PCB Land Pattern

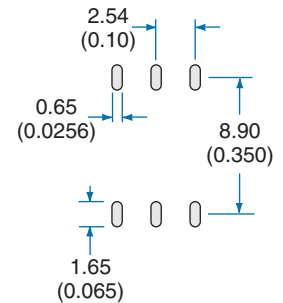

Dimensions
mm
(inches)

CPC1943GS Tape & Reel

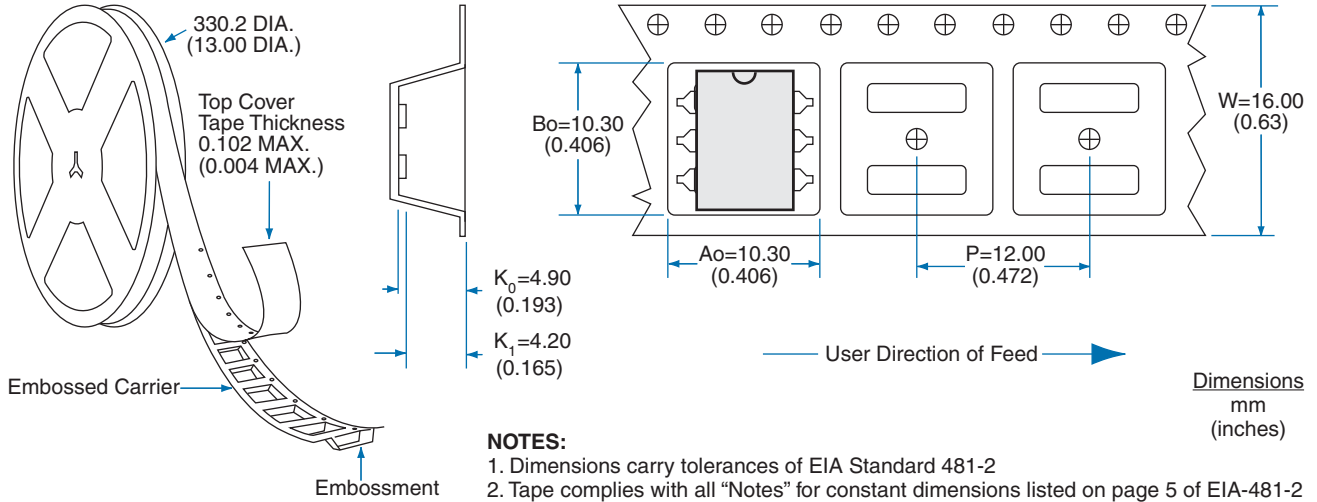

For additional information please visit our website at: www.clare.com

Clare, Inc. makes no representations or warranties with respect to the accuracy or completeness of the contents of this publication and reserves the right to make changes to specifications and product descriptions at any time without notice. Neither circuit patent licenses nor indemnity are expressed or implied. Except as set forth in Clare's Standard Terms and Conditions of Sale, Clare, Inc. assumes no liability whatsoever, and disclaims any express or implied warranty, relating to its products including, but not limited to, the implied warranty of merchantability, fitness for a particular purpose, or infringement of any intellectual property right.

The products described in this document are not designed, intended, authorized or warranted for use as components in systems intended for surgical implant into the body, or in other applications intended to support or sustain life, or where malfunction of Clare's product may result in direct physical harm, injury, or death to a person or severe property or environmental damage. Clare, Inc. reserves the right to discontinue or make changes to its products at any time without notice.

Specification: DS-CPC1943-R06
©Copyright 2010, Clare, Inc.
OptoMOS® is a registered trademark of Clare, Inc.
All rights reserved. Printed in USA.
11/18/2010