

# MOS FET Relays G3VM-21LR11

High-power, 0.9-A Switching with SSOP Package in a 20-V Load Voltage Model.

- RoHS compliant

## Application Examples

- Semiconductor inspection tools
- Measurement devices
- Broadband systems
- Data loggers



**NEW**

**Note:** The actual product is marked differently from the image shown here.

## List of Models

Contact form	Terminals	Load voltage (peak value)	Model	Number per tape
SPST-NO	Surface-mounting terminals	20 V	G3VM-21LR11	---
			G3VM-21LR11(TR05)	500
			G3VM-21LR11(TR)	1,500

**Note:** Use "TR05" instead of "TR" in the part number, to obtain reels with 500 pc/reel. (e.g., G3VM-21LR11(TR05))

## Dimensions

**Note:** All units are in millimeters unless otherwise indicated.

### G3VM-21LR11

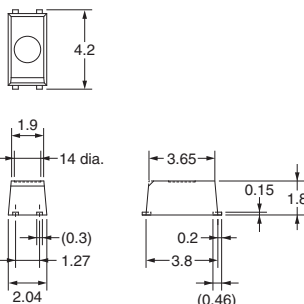
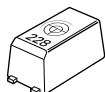

**Note:** A tolerance of  $\pm 0.1$  mm applies to all dimensions unless otherwise specified.

Weight: 0.03 g

**Note:** The actual product is marked differently from the image shown here.

## Terminal Arrangement/Internal Connections (Top View)

### G3VM-21LR11

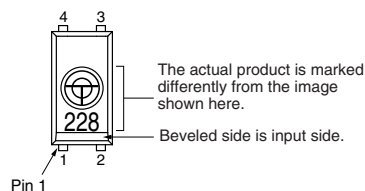
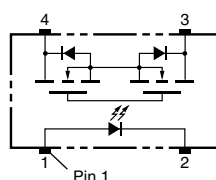

## Actual Mounting Pad Dimensions (Recommended Value, Top View)

### G3VM-21LR11

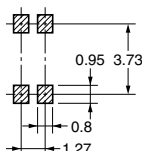

■ Absolute Maximum Ratings (Ta = 25°C)

Item		Symbol	Rating	Unit	Measurement Conditions
Input	LED forward current	$I_F$	50	mA	
	LED forward current reduction rate	$\Delta I_F/^\circ\text{C}$	-0.5	mA/°C	$T_a \geq 25^\circ\text{C}$
	LED reverse voltage	$V_R$	5	V	
	Connection temperature	$T_j$	125	°C	
Output	Load voltage (AC peak/DC)	$V_{OFF}$	20	V	
	Continuous load current (AC peak/DC)	$I_O$	900	mA	
	ON current reduction rate	$\Delta I_O/^\circ\text{C}$	-12	mA/°C	$T_a \geq 50^\circ\text{C}$
	Connection temperature	$T_j$	125	°C	
Dielectric strength between input and output (See note 1.)		$V_{I-O}$	1,500	$V_{rms}$	AC for 1 min
Ambient operating temperature		$T_a$	-20 to +85	°C	With no icing or condensation
Storage temperature		$T_{stg}$	-40 to +125	°C	With no icing or condensation
Soldering temperature		---	260	°C	10 s

Note: 1. The dielectric strength between the input and output was checked by applying voltage between all pins as a group on the LED side and all pins as a group on the light-receiving side.

■ Electrical Characteristics (Ta = 25°C)

Item		Symbol	Minimum	Typical	Maximum	Unit	Measurement conditions
Input	LED forward voltage	$V_F$	1.0	1.15	1.3	V	$I_F = 10 \text{ mA}$
	Reverse current	$I_R$	---	---	10	$\mu\text{A}$	$V_R = 5 \text{ V}$
	Capacity between terminals	$C_T$	---	15	---	pF	$V = 0, f = 1 \text{ MHz}$
	Trigger LED forward current	$I_{FT}$	---	---	3.0	mA	$I_O = 100 \text{ mA}$
Output	Maximum resistance with output ON	$R_{ON}$	---	0.18	0.22	$\Omega$	$I_F = 5 \text{ mA}, I_O = 900 \text{ mA}, t < 1 \text{ s}$
	Current leakage when the relay is open	$I_{LEAK}$	---	0.2	1.0	nA	$V_{OFF} = 20 \text{ V}$
	Capacity between terminals	$C_{OFF}$	---	40	80	pF	$V = 0, f = 100 \text{ MHz}, t < 1 \text{ s}$
Capacity between I/O terminals		$C_{I-O}$	---	0.3	---	pF	$f = 1 \text{ MHz}, V_s = 0 \text{ V}$
Insulation resistance between I/O terminals		$R_{I-O}$	1,000	---	---	M $\Omega$	$V_{I-O} = 500 \text{ VDC}, R_{OH} \leq 60\%$
Turn-ON time		$t_{ON}$	---	0.3	2.0	ms	$I_F = 5 \text{ mA}, R_L = 200 \Omega, V_{DD} = 10 \text{ V}$ (See note 2.)
Turn-OFF time		$t_{OFF}$	---	0.2	1.0	ms	

Note: 2. Turn-ON and Turn-OFF Times

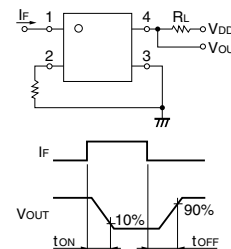

■ Recommended Operating Conditions

Use the G3VM under the following conditions so that the Relay will operate properly.

Item	Symbol	Minimum	Typical	Maximum	Unit
Load voltage (AC peak/DC)	$V_{DD}$	---	---	20	V
Operating LED forward current	$I_F$	---	---	20	mA
Continuous load current (AC peak/DC)	$I_O$	---	---	900	mA
Operating temperature	$T_a$	-20	---	65	°C

■ Engineering Data

**LED forward current vs. Ambient temperature**  
IF - Ta

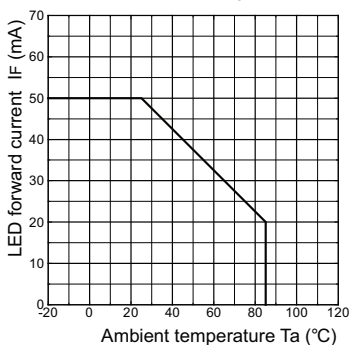

**Continuous load current vs. Ambient temperature**  
IO - Ta

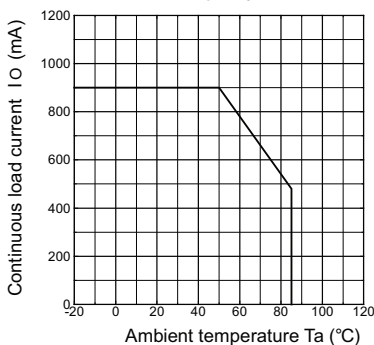

**LED forward current vs. LED forward voltage**  
IF - VF

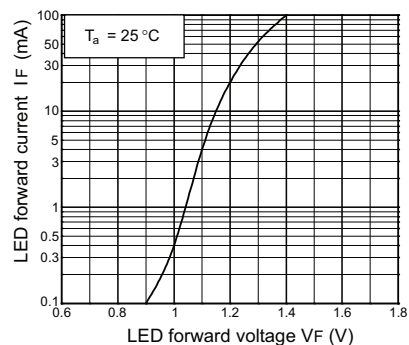

**Continuous load current vs. On-state voltage**  
IO - VON

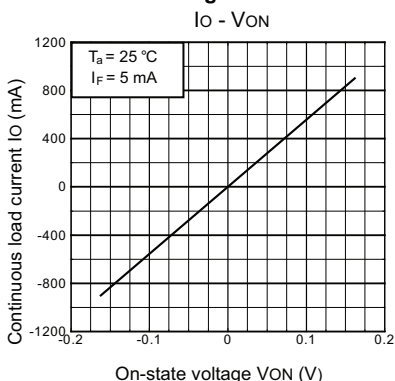

**On-state resistance vs. Ambient temperature**  
RON - Ta

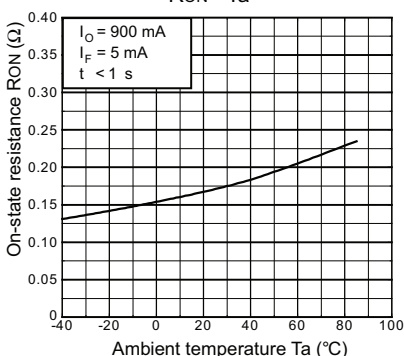

**Trigger LED forward current vs. Ambient temperature**  
IFT - Ta

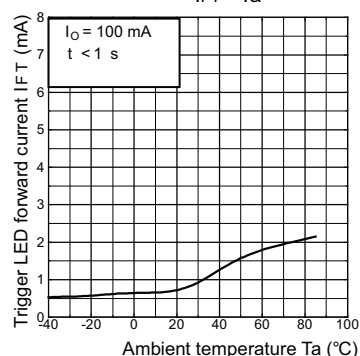

**Turn ON, Turn OFF time vs. LED forward current**  
tON, tOFF - IF

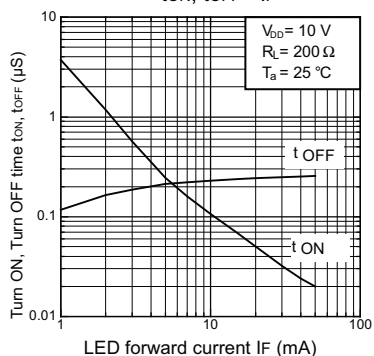

**Turn ON, Turn OFF time vs. Ambient temperature**  
tON, tOFF - Ta

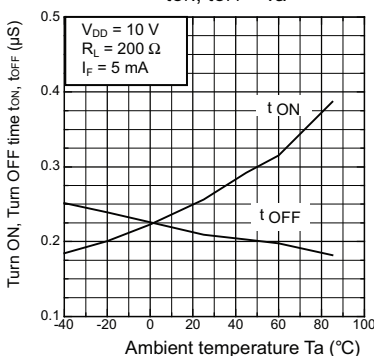

**Current leakage vs. Load voltage**  
ILEAK - VOFF

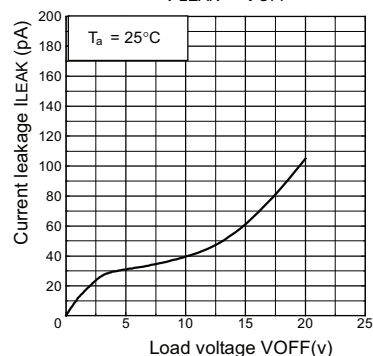

**Output terminal capacitance COFF/COFF(ov) vs. Load voltage**  
COFF - VOFF

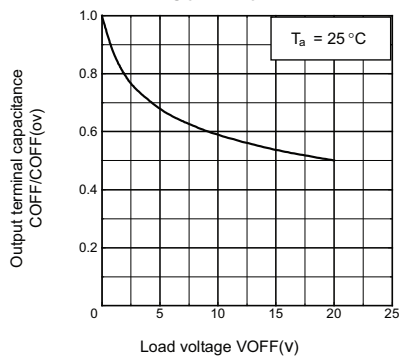

All sales are subject to Omron Electronic Components LLC standard terms and conditions of sale, which can be found at [http://www.components.omron.com/components/web/webfiles.nsf/sales\\_terms.html](http://www.components.omron.com/components/web/webfiles.nsf/sales_terms.html)

**ALL DIMENSIONS SHOWN ARE IN MILLIMETERS.**  
To convert millimeters into inches, multiply by 0.03937. To convert grams into ounces, multiply by 0.03527.

---

**OMRON**<sup>®</sup>

**OMRON ELECTRONIC  
COMPONENTS LLC**

55 E. Commerce Drive, Suite B  
Schaumburg, IL 60173

**847-882-2288**

**OMRON ON-LINE**

Global - <http://www.omron.com>

USA - <http://www.components.omron.com>

Cat. No. X302-E-1

12/10

Specifications subject to change without notice

Printed in USA

---

MOS FET Relays **G3VM-21LR11**