



Parameter	Rating	Units
Load Voltage	60	V
Load Current	1	A
Max On-resistance	0.4	Ω

### Features

- 3750V<sub>rms</sub> Input/Output Isolation
- Small 8-Pin Package
- Low Drive Power Requirements (TTL/CMOS Compatible)
- Arc-Free With No Snubbing Circuits
- No EMI/RFI Generation
- Machine Insertable, Wave Solderable
- Surface Mount Version
- Tape & Reel available

### Applications

- Telecommunications
- Instrumentation
  - Multiplexers
  - Data Acquisition
  - Electronic Switching
  - I/O Subsystems
  - Utility Meters (gas, oil, electric and water)
- Medical Equipment-Patient/Equipment Isolation
- Security
- Aerospace
- Industrial Controls

### Pin Configuration

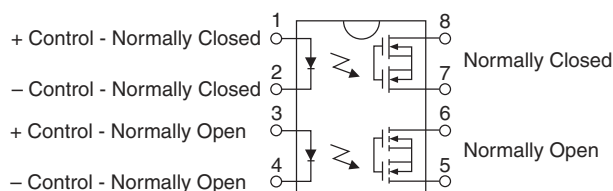

### Description

LBA716 is a 60V, 1A, 0.4Ω dual Solid State Relay integrating independent normally open (1-Form-A) and normally closed (1-Form-B) relays into a single package. It features a superior combination of low on-resistance and enhanced peak load current (5A max.) handling capability.

### Approvals

- UL Recognized Component: File # E76270
- CSA Certified Component: Certificate # 1175739
- EN/IEC 60950-1 Certified Component  
TUV Certificate B 09 07 49410 004

### Ordering Information

Part #	Description
LBA716	8-Pin DIP (50/Tube)
LBA716S	8-Pin Surface Mount (50/Tube)
LBA716STR	8-Pin Surface Mount (1000/Reel)

Switching Characteristics of Normally Open Devices

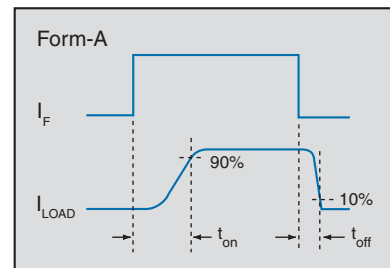

Switching Characteristics of Normally Closed Devices

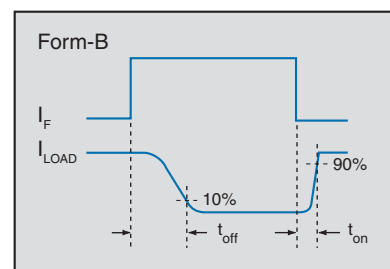

## Absolute Maximum Ratings @ 25°C

Parameter	Ratings	Units
Blocking Voltage	60	V <sub>P</sub>
Reverse Input Voltage	5	V
Input Control Current	50	mA
Peak (10ms)	1	A
Input Power Dissipation <sup>1</sup>	150	mW
Total Power Dissipation <sup>2</sup>	800	mW
Isolation Voltage, Input to Output	3750	V <sub>rms</sub>
Operational Temperature	-40 to +85	°C
Storage Temperature	-40 to +125	°C

<sup>1</sup> Derate Linearly 1.33 mW/°C

<sup>2</sup> Derate Linearly 6.67 mW/°C

Absolute Maximum Ratings are stress ratings. Stresses in excess of these ratings can cause permanent damage to the device. Functional operation of the device at conditions beyond those indicated in the operational sections of this data sheet is not implied.

## Electrical Characteristics @ 25°C

Parameter	Conditions	Symbol	Min	Typ	Max	Units
<b>Characteristics: Form-A (Normally Open)</b>						
Load Current						
Continuous	-	I <sub>L</sub>	-	-	1	A
Peak	t ≤ 10ms	I <sub>LPK</sub>	-	-	5	
On-resistance	I <sub>L</sub> =1A	R <sub>ON</sub>	-	0.21	0.4	Ω
Off-State Leakage Current	V <sub>L</sub> =60V	I <sub>LEAK</sub>	-	-	1	μA
Output Capacitance	50V, f=1MHz	C <sub>OUT</sub>	-	105	-	pF
Switching Speeds						
Turn-On	I <sub>F</sub> =5mA, V <sub>L</sub> =10V	t <sub>ON</sub>	-	0.7	5	ms
Turn-Off		t <sub>OFF</sub>	-	0.09	5	
Input Control Current	I <sub>L</sub> =1A	I <sub>F</sub>	-	-	2	mA
Input Dropout Current	-	I <sub>F</sub>	0.1	-	-	mA
<b>Characteristics: Form-B (Normally Closed)</b>						
Load Current						
Continuous	-	I <sub>L</sub>	-	-	0.5	A
Peak	t ≤ 10ms	I <sub>LPK</sub>	-	-	1.2	
On-resistance	I <sub>L</sub> =0.5A	R <sub>ON</sub>	-	1.63	2	Ω
Off-State Leakage Current	V <sub>L</sub> =60V, I <sub>F</sub> =5mA	I <sub>LEAK</sub>	-	-	1	μA
Output Capacitance	I <sub>F</sub> =5mA, 50V, f=1MHz	C <sub>OUT</sub>	-	280	-	pF
Switching Speeds						
Turn-On	I <sub>F</sub> =5mA, V <sub>L</sub> =10V	t <sub>ON</sub>	-	0.58	5	ms
Turn-Off		t <sub>OFF</sub>	-	0.76	5	
Input Control Current	-	I <sub>F</sub>	-	-	2	mA
Input Dropout Current	I <sub>L</sub> =0.5A	I <sub>F</sub>	0.1	-	-	mA
<b>Common Characteristics: Form-A and Form-B</b>						
Input Voltage Drop	I <sub>F</sub> =5mA	V <sub>F</sub>	0.9	1.2	1.4	V
Reverse Input Current	V <sub>R</sub> =5V	I <sub>R</sub>	-	-	10	μA
Capacitance, Input to Output	-	C <sub>I/O</sub>	-	3	-	pF

\*NOTE: If both poles operate simultaneously load current must be derated so as not to exceed the package power dissipation value.

**PERFORMANCE DATA\***

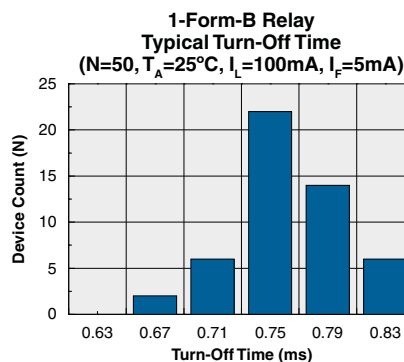
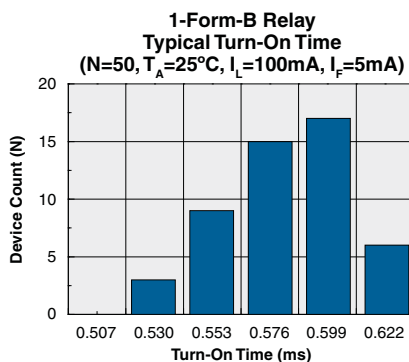
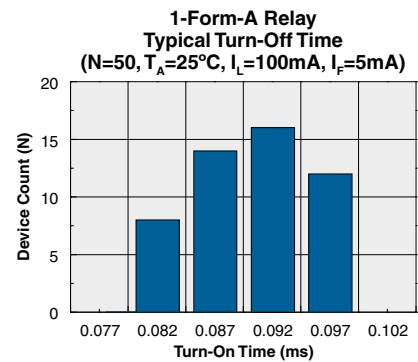
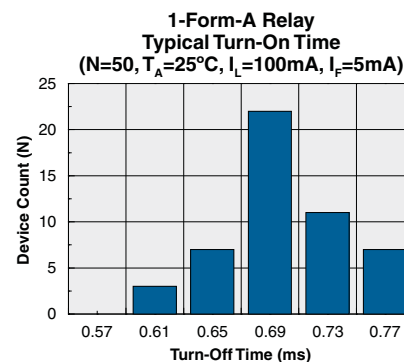
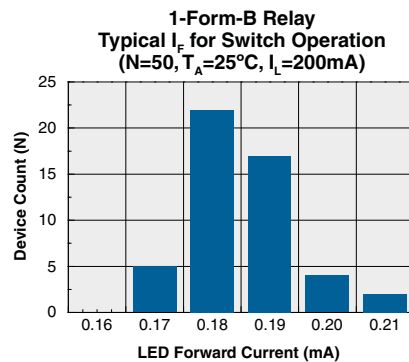
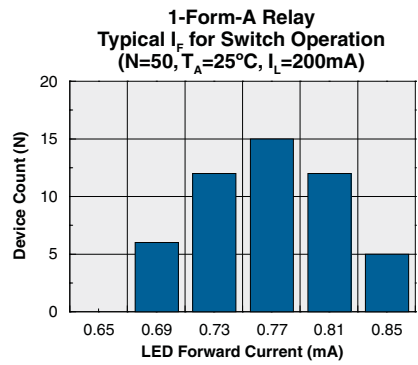
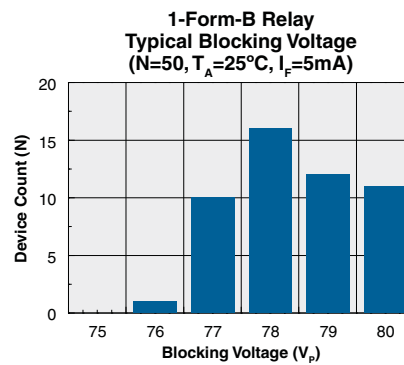
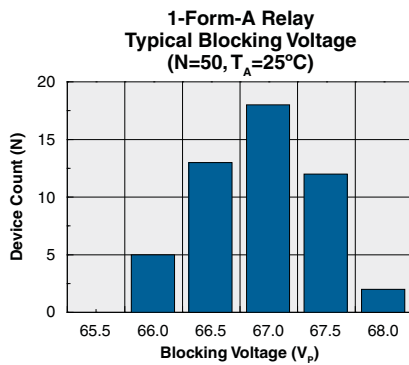
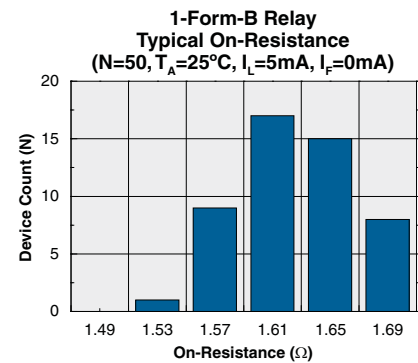
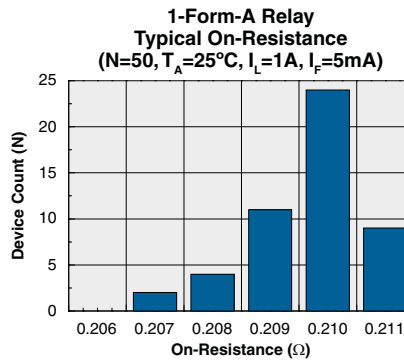
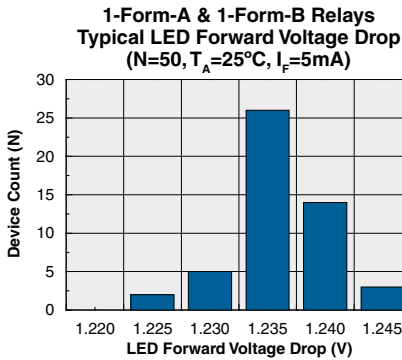

\*The Performance data shown in the graphs above is typical of device performance. For guaranteed parameters not indicated in the written specifications, please contact our application department.

**PERFORMANCE DATA\***

**Form-A Relay**  
Typical Load Current vs. Temperature  
( $I_F=5mA$ )

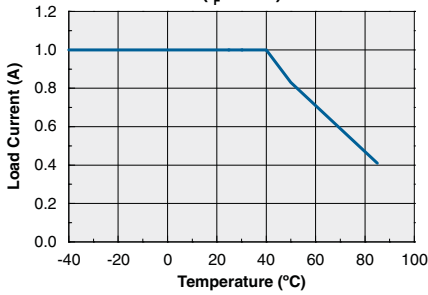

**1-Form-A Relay**  
Typical Leakage vs. Temperature  
Measured Across Pins 5 & 6  
( $V_L=60V$ )

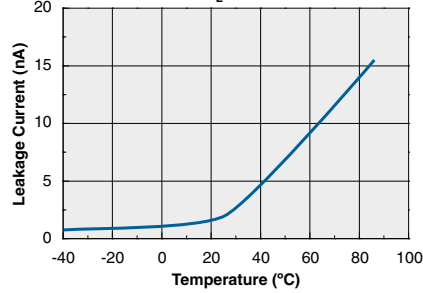

**1-Form-A Relay**  
Typical Blocking Voltage vs. Temperature

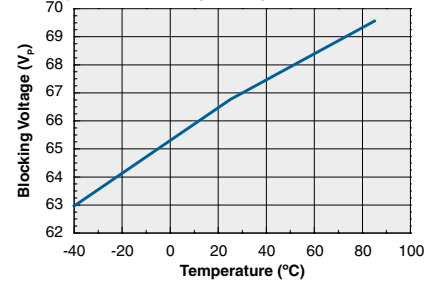

**1-Form-A Relay**  
Typical Turn-On vs. Temperature  
( $I_L=100mA$ )

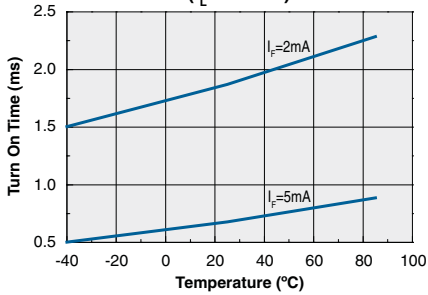

**1-Form-A Relay**  
Typical Turn-Off vs. Temperature  
( $I_L=100mA$ )

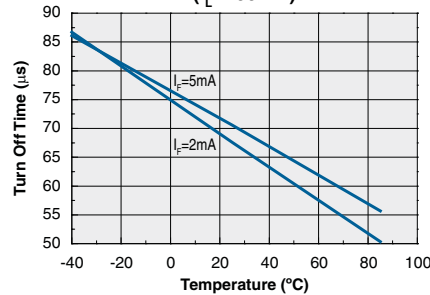

**1-Form-A Relay**  
Typical Turn-On vs. LED Forward Current  
( $I_L=100mA$ )

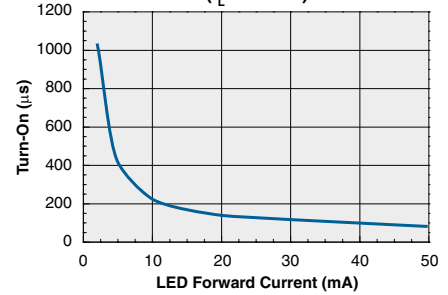

**1-Form-A Relay**  
Typical Turn-Off vs. LED Forward Current  
( $I_L=100mA$ )

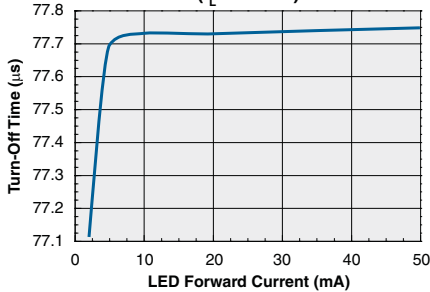

**1-Form-A Relay**  
Typical On-Resistance (AC)  
vs. Temperature  
( $I_L=500mA, I_F=5mA$ )

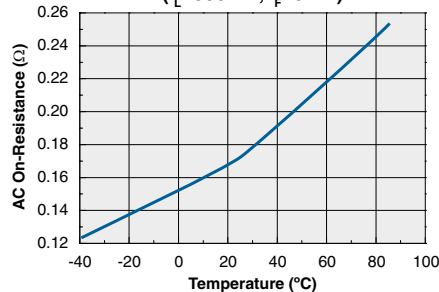

**1-Form-A Relay**  
Typical  $I_F$  for Switch Operation  
vs. Temperature  
( $I_L=200mA$ )

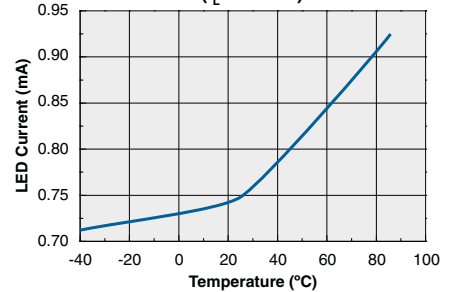

**1-Form-A Relay**  
Typical Load Current vs. Load Voltage  
( $T_A=25°C, I_F=5mA$ )

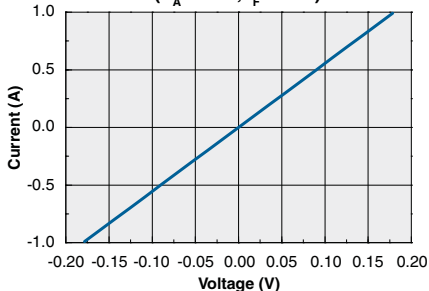

**1-Form-A Relay**  
Energy Rating Curve

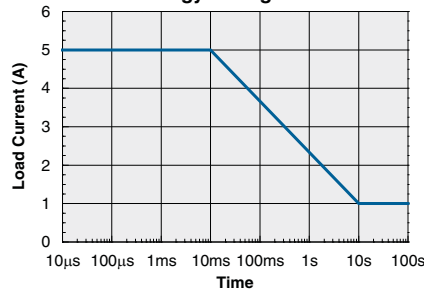

\*The Performance data shown in the graphs above is typical of device performance. For guaranteed parameters not indicated in the written specifications, please contact our application department.

**PERFORMANCE DATA\***

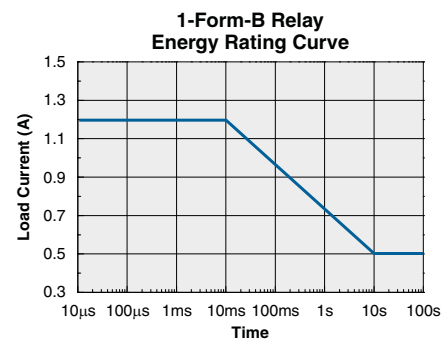
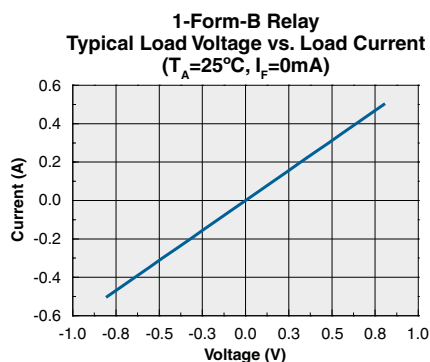
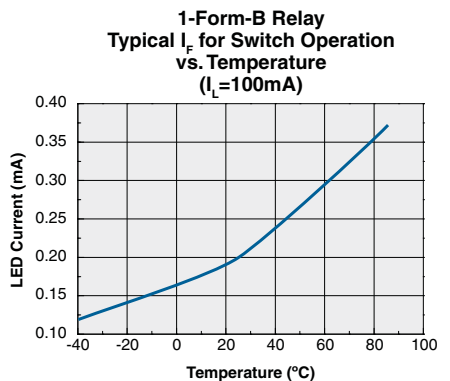
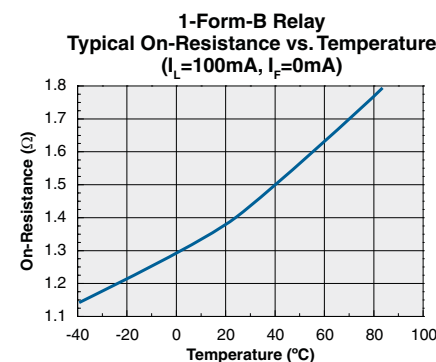
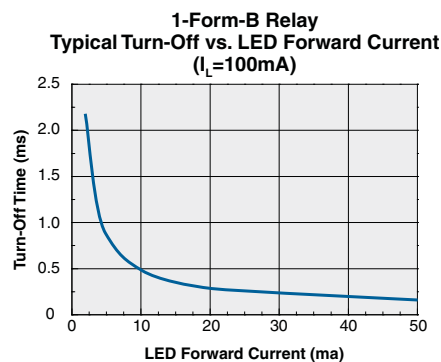
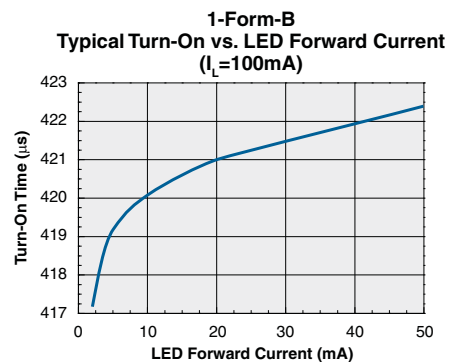
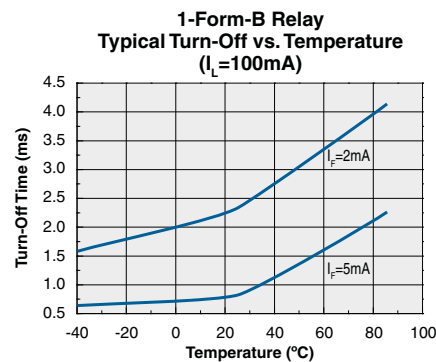
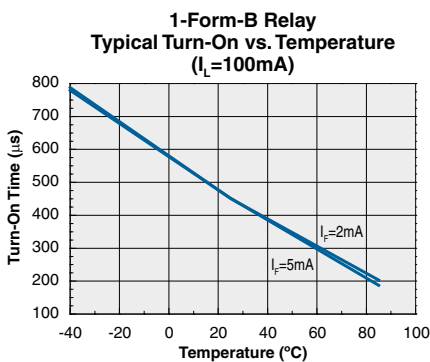
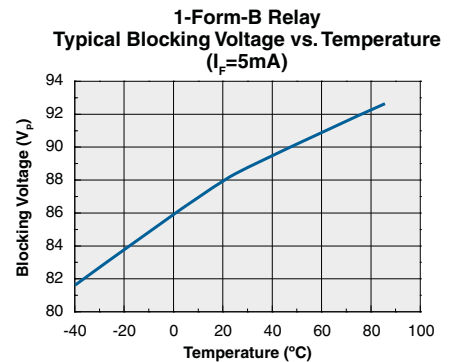
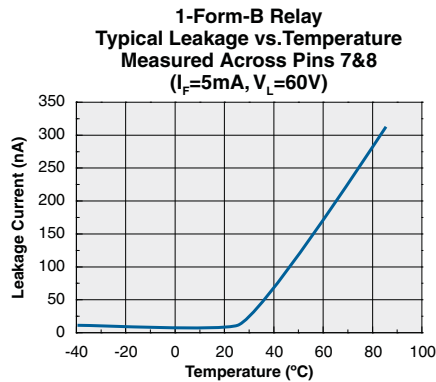
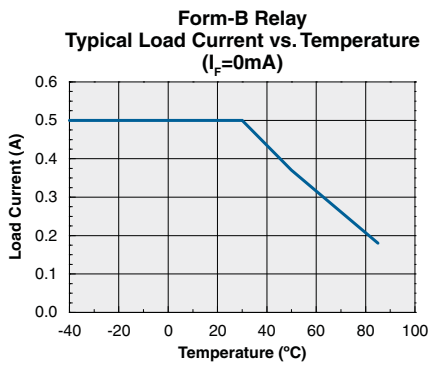

\*The Performance data shown in the graphs above is typical of device performance. For guaranteed parameters not indicated in the written specifications, please contact our application department.

## Manufacturing Information

### Moisture Sensitivity



All plastic encapsulated semiconductor packages are susceptible to moisture ingress. Clare classified all of its plastic encapsulated devices for moisture sensitivity according to the latest version of the joint industry standard, **IPC/JEDEC J-STD-020**, in force at the time of product evaluation. We test all of our products to the maximum conditions set forth in the standard, and guarantee proper operation of our devices when handled according to the limitations and information in that standard as well as to any limitations set forth in the information or standards referenced below.

Failure to adhere to the warnings or limitations as established by the listed specifications could result in reduced product performance, reduction of operable life, and/or reduction of overall reliability.

This product is rated **Moisture Sensitivity Level 1 (MSL 1)**, and should be handled according to the requirements of the latest version of the joint industry standard **IPC/JEDEC J-STD-033**.

### ESD Sensitivity



This product is **ESD Sensitive**, and should be handled according to the industry standard **JESD-625**.

### Reflow Profile

This product has a maximum body temperature rating of **250°C for a maximum of 30 seconds**. All other guidelines of **J-STD-020** must be observed.

### Board Wash

Clare recommends the use of no-clean flux formulations. However, board washing to remove flux residue is acceptable. Since Clare employs the use of silicone coating as an optical waveguide in many of its optically isolated products, the use of a short drying bake could be necessary if a wash is used after solder reflow processes. Chlorine- or Fluorine-based solvents or fluxes should not be used. Cleaning methods that employ ultrasonic energy should not be used.



**Mechanical Dimensions**

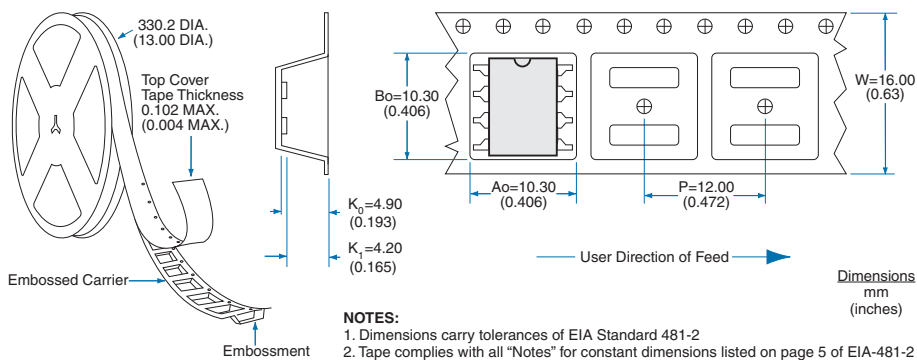
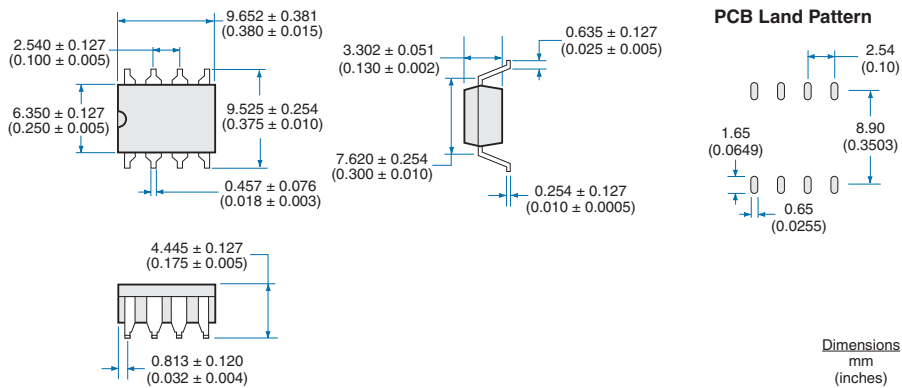
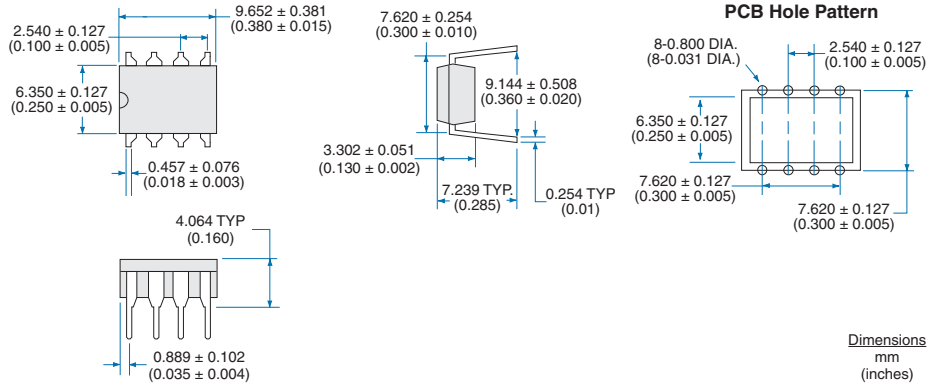

For additional information please visit our website at: [www.clare.com](http://www.clare.com)

Clare, Inc. makes no representations or warranties with respect to the accuracy or completeness of the contents of this publication and reserves the right to make changes to specifications and product descriptions at any time without notice. Neither circuit patent licenses nor indemnity are expressed or implied. Except as set forth in Clare's Standard Terms and Conditions of Sale, Clare, Inc. assumes no liability whatsoever, and disclaims any express or implied warranty, relating to its products including, but not limited to, the implied warranty of merchantability, fitness for a particular purpose, or infringement of any intellectual property right.

The products described in this document are not designed, intended, authorized or warranted for use as components in systems intended for surgical implant into the body, or in other applications intended to support or sustain life, or where malfunction of Clare's product may result in direct physical harm, injury, or death to a person or severe property or environmental damage. Clare, Inc. reserves the right to discontinue or make changes to its products at any time without notice.

Specification: DS-LBA716-R02  
©Copyright 2010, Clare, Inc.  
OptoMOS® is a registered trademark of Clare, Inc.  
All rights reserved. Printed in USA.  
6/7/2010