



Parameter	Rating	Units
Blocking Voltage	30	V <sub>P</sub>
Load Current	1.2	A <sub>DC</sub>
On-resistance, Max	0.25	Ω

### Features

- 1500V<sub>rms</sub> Input/Output Isolation
- Small 4-Lead SOP Package
- Low Drive Power Requirements (TTL/CMOS Compatible)
- No Moving Parts
- High Reliability
- Arc-Free With No Snubbing Circuits
- No EMI/RFI Generation
- Machine Insertable, Wave Solderable
- Tape & Reel Version Available

### Applications

- Sensor Circuitry
- Instrumentation
- Multiplexers
- Data Acquisition
- Electronic Switching
- I/O Subsystems
- Meters (Watt-Hour, Water, Gas)
- Medical Equipment—Patient/Equipment Isolation
- Aerospace
- Industrial Controls

### Description

The CPC1020N is a 30V, single-pole, normally open (1-Form-A) Solid State Relay. The ultra-low on-resistance, 0.25Ω, of this relay allows for high-current operation.

Clare's patented OptoMOS architecture makes available the optically coupled technology necessary to activate the output's efficient MOSFET switches while providing 1500V<sub>rms</sub> input to output isolation. Control of the isolated output is accomplished by means of the highly effective GaAlAs infrared LED at the input.

### Approvals

- UL Recognized Component: File E76270
- CSA Certified Component: Certificate 1175739
- EN/IEC 60950-1 Certified Component:  
TUV Certificate B 09 07 49410 004

### Ordering Information

Part #	Description
CPC1020N	4-Lead SOP (100/tube)
CPC1020NTR	4-Lead SOP (2000/reel)

### Pin Configuration

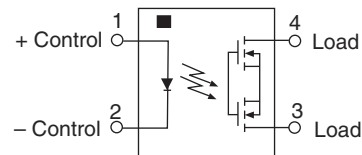

### Switching Characteristics of Normally Open Devices

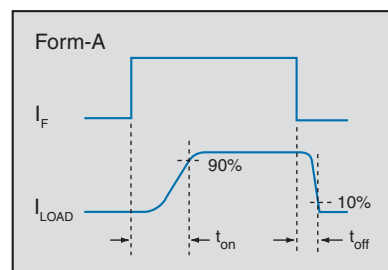

**Absolute Maximum Ratings @ 25°C**

Parameter	Ratings	Units
Blocking Voltage	30	V <sub>P</sub>
Input Power Dissipation <sup>1</sup>	75	mW
Input Control Current	50	mA
Peak (10ms)	1	A
Reverse Input Voltage	5	V
Total Power Dissipation <sup>2</sup>	400	mW
Isolation voltage, Input to Output	1500	V <sub>rms</sub>
Operational Temperature	-40 to +85	°C
Storage Temperature	-40 to +125	°C

*Absolute Maximum Ratings are stress ratings. Stresses in excess of these ratings can cause permanent damage to the device. Functional operation of the device at conditions beyond those indicated in the operational sections of this data sheet is not implied.*

<sup>1</sup> Derate linearly 1.33 mW / °C

<sup>2</sup> Derate linearly 3.33 mW / °C

**Electrical Characteristics @ 25°C**

Parameter	Conditions	Symbol	Min	Typ	Max	Units
<b>Output Characteristics</b>						
Load Current						
Continuous <sup>1</sup>	I <sub>F</sub> =2mA	I <sub>L</sub>	-	-	1.2	A <sub>DC</sub>
Peak	t ≤ 10ms	I <sub>LPK</sub>	-	-	3	A
On-Resistance <sup>2</sup>	I <sub>L</sub> =1A	R <sub>ON</sub>	-	0.116	0.25	Ω
Off-State Leakage Current	V <sub>L</sub> =30V <sub>P</sub>	I <sub>LEAK</sub>	-	-	1	μA
Switching Speeds						
Turn-On	I <sub>F</sub> =5mA, V <sub>L</sub> =10V	t <sub>on</sub>	-	0.48	3	ms
Turn-Off		t <sub>off</sub>	-	0.65	3	
Output Capacitance	V <sub>L</sub> =15V, f=1MHz	C <sub>OUT</sub>	-	70	-	pF
<b>Input Characteristics</b>						
Input Control Current	I <sub>L</sub> =1A	I <sub>F</sub>	-	0.13	2	mA
Input Dropout Current	-	I <sub>F</sub>	0.1	-	-	mA
Input Voltage Drop	I <sub>F</sub> =5mA	V <sub>F</sub>	0.9	1.2	1.4	V
Reverse Input Current	V <sub>R</sub> =5V	I <sub>R</sub>	-	-	10	μA
<b>Input/Output Characteristics</b>						
Capacitance, Input to Output	-	C <sub>I/O</sub>	-	3	-	pF

<sup>1</sup> Load current derates linearly from 1.2A @ 25°C to 0.58A @ 85°C.

<sup>2</sup> Measurement taken within 1 second of on-time.

**ESD Rating**

<b>ESD Rating (Human Body Model)</b>
1000 Volts

**PERFORMANCE DATA\***

**Typical Turn-On Time Distribution**  
(N=50,  $I_F=5\text{mA}$ ,  $I_L=5\text{mA}$ ,  $T_A=25^\circ\text{C}$ )

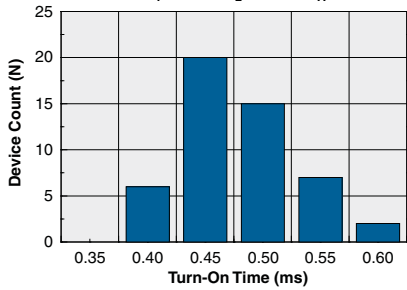

**Typical Turn-Off Time Distribution**  
(N=50,  $I_F=5\text{mA}$ ,  $I_L=5\text{mA}$ ,  $T_A=25^\circ\text{C}$ )

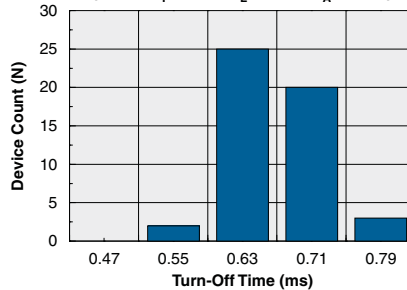

**Typical On-Resistance Distribution**  
(N=50,  $I_F=2\text{mA}$ ,  $I_L=1\text{A}$ ,  $T_A=25^\circ\text{C}$ )

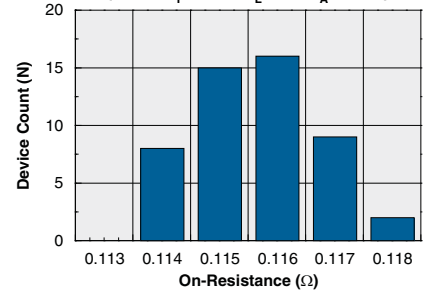

**Typical  $I_F$  for Switch Operation**  
(N=50,  $I_L=100\text{mA}$ ,  $T_A=25^\circ\text{C}$ )

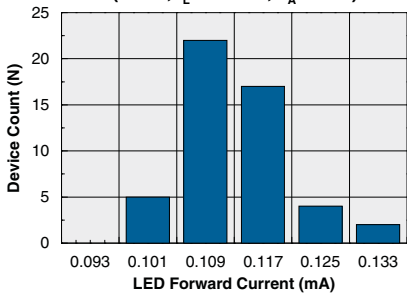

**Typical Blocking Voltage Distribution**  
(N=50,  $T_A=25^\circ\text{C}$ )

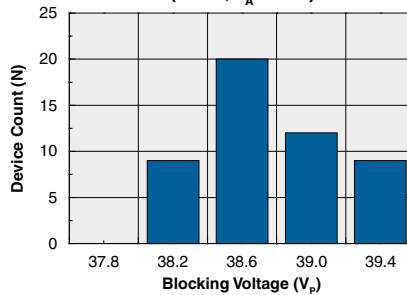

**Typical LED Forward Voltage Drop**  
(N=50,  $I_F=5\text{mA}$ ,  $T_A=25^\circ\text{C}$ )

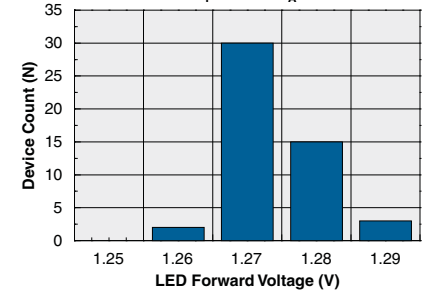

**Typical LED Forward Voltage Drop vs. Temperature**

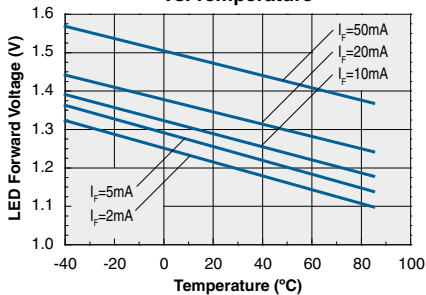

**Typical Turn-On Time vs. LED Forward Current**  
( $I_L=100\text{mA}$ )

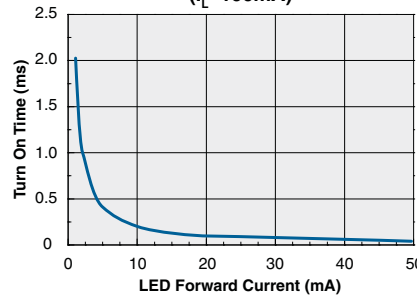

**Typical Turn-Off Time vs. LED Forward Current**  
( $I_L=100\text{mA}$ )

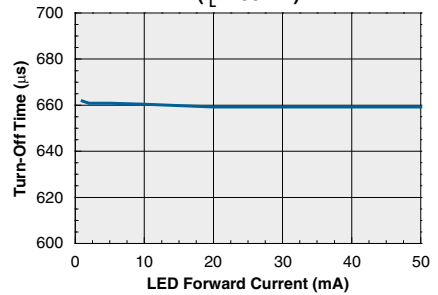

**Typical  $I_F$  for Switch Operation vs. Temperature**  
( $I_L=1\text{A}$ )

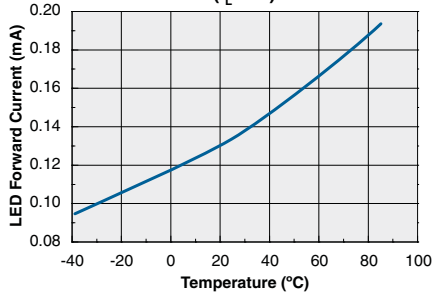

**Typical Turn-On Time vs. Temperature**  
( $I_L=100\text{mA}$ )

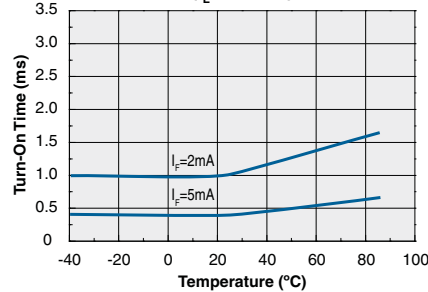

**Typical Turn-Off Time vs. Temperature**  
( $I_L=100\text{mA}$ )

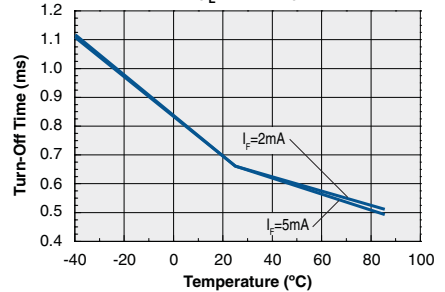

\*The Performance data shown in the graphs above is typical of device performance. For guaranteed parameters not indicated in the written specifications, please contact our application department.

**PERFORMANCE DATA\***

**Typical Load Voltage vs. Load Current**  
( $I_F=2\text{mA}$ ,  $T_A=25^\circ\text{C}$ )

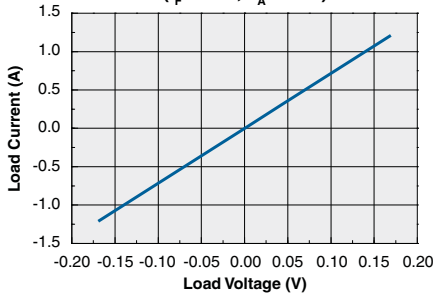

**Typical On-Resistance vs. Temperature**  
( $I_F=2\text{mA}$ ,  $I_L=0.5\text{A}$ )

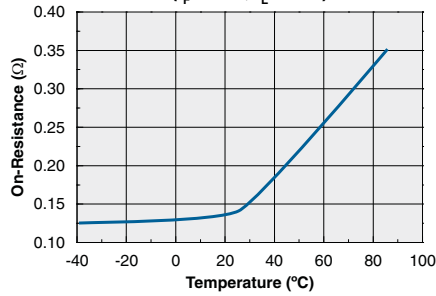

**Typical Load Current vs. Temperature**  
( $I_F=2\text{mA}$ )

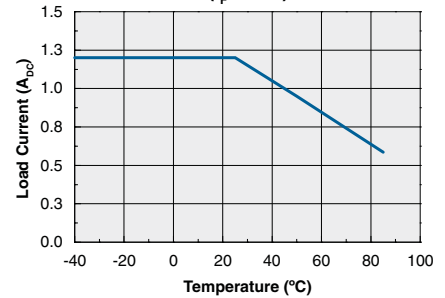

**Typical Blocking Voltage vs. Temperature**  
( $I_L=1\mu\text{A}$ )

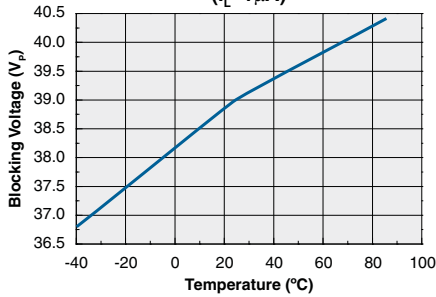

**Typical Leakage Current vs. Temperature Measured Across Pins 3&4**  
( $I_F=0\text{mA}$ ,  $V_L=30\text{V}$ )

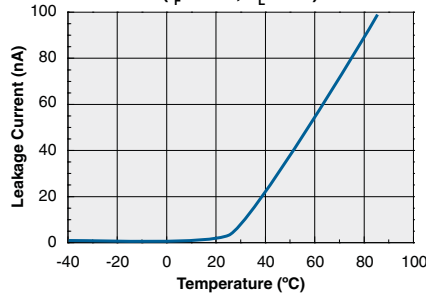

**Energy Rating Curve**

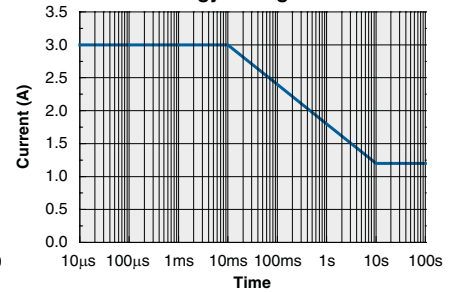

\*The Performance data shown in the graphs above is typical of device performance. For guaranteed parameters not indicated in the written specifications, please contact our application department.

**Manufacturing Information**

**Moisture Sensitivity**



All plastic encapsulated semiconductor packages are susceptible to moisture ingress. Clare classified all of its plastic encapsulated devices for moisture sensitivity according to the latest version of the joint industry standard, **IPC/JEDEC J-STD-020**, in force at the time of product evaluation. We test all of our products to the maximum conditions set forth in the standard, and guarantee proper operation of our devices when handled according to the limitations and information in that standard as well as to any limitations set forth in the information or standards referenced below.

Failure to adhere to the warnings or limitations as established by the listed specifications could result in reduced product performance, reduction of operable life, and/or reduction of overall reliability.

This product carries a **Moisture Sensitivity Level (MSL) rating** as shown below, and should be handled according to the requirements of the latest version of the joint industry standard **IPC/JEDEC J-STD-033**.

Device	Moisture Sensitivity Level (MSL) Rating
CPC1020N	MSL 3

**ESD Sensitivity**



This product is **ESD Sensitive**, and should be handled according to the industry standard **JESD-625**.

**Reflow Profile**

This product has a maximum body temperature and time rating as shown below. All other guidelines of **J-STD-020** must be observed.

Device	Maximum Temperature x Time
CPC1020N	260°C for 30 seconds

**Board Wash**

Clare recommends the use of no-clean flux formulations. However, board washing to remove flux residue is acceptable. Since Clare employs the use of silicone coating as an optical waveguide in many of its optically isolated products, the use of a short drying bake could be necessary if a wash is used after solder reflow processes. Chlorine- or Fluorine-based solvents or fluxes should not be used. Cleaning methods that employ ultrasonic energy should not be used.



**MECHANICAL DIMENSIONS**

**CPC1020N**

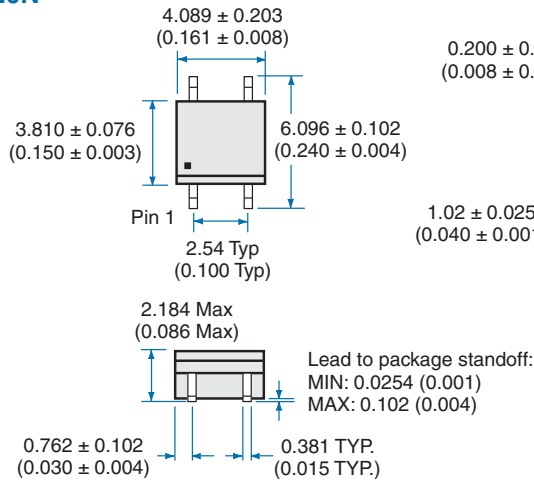

**Recommended PCB Land Pattern**

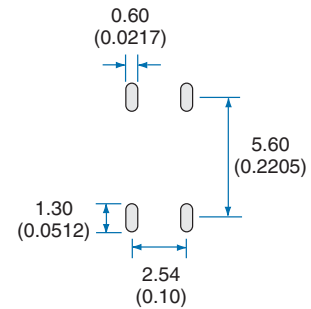

Dimensions  
mm  
(inches)

**CPC1020N Tape & Reel**

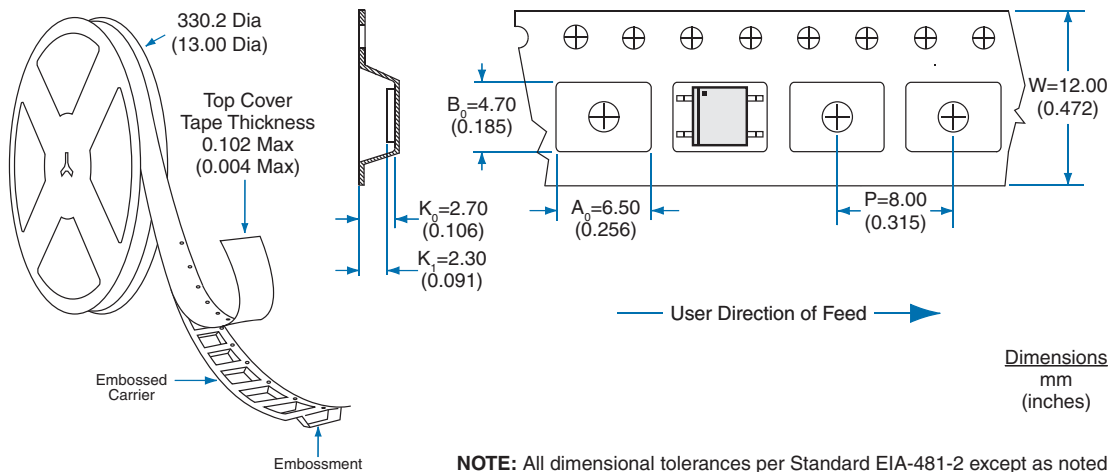

Dimensions  
mm  
(inches)

**NOTE:** All dimensional tolerances per Standard EIA-481-2 except as noted

**For additional information please visit our website at: [www.clare.com](http://www.clare.com)**

Clare, Inc. makes no representations or warranties with respect to the accuracy or completeness of the contents of this publication and reserves the right to make changes to specifications and product descriptions at any time without notice. Neither circuit patent licenses nor indemnity are expressed or implied. Except as set forth in Clare's Standard Terms and Conditions of Sale, Clare, Inc. assumes no liability whatsoever, and disclaims any express or implied warranty, relating to its products including, but not limited to, the implied warranty of merchantability, fitness for a particular purpose, or infringement of any intellectual property right.

The products described in this document are not designed, intended, authorized or warranted for use as components in systems intended for surgical implant into the body, or in other applications intended to support or sustain life, or where malfunction of Clare's product may result in direct physical harm, injury, or death to a person or severe property or environmental damage. Clare, Inc. reserves the right to discontinue or make changes to its products at any time without notice.

Specification: DS-CPC1020N-R02  
©Copyright 2010, Clare, Inc.  
OptoMOS® is a registered trademark of Clare, Inc.  
All rights reserved. Printed in USA.  
8/27/2010