



Parameter	Rating	Units
Blocking Voltage	350	V _P
Load Current	120	mA
Max On-resistance	50	Ω

Features

- 1500V_{rms} Input/Output Isolation
- Small 4-Pin SOP Package
- Low Drive Power Requirements (TTL/CMOS Compatible)
- No Moving Parts
- High Reliability
- Arc-Free With No Snubbing Circuits
- No EMI/RFI Generation
- Machine Insertable, Wave Solderable
- Tape & Reel Version Available

Applications

- Telecommunications
 - Telecom Switching
 - Tip/Ring Circuits
 - Modem Switching (Laptop, Notebook, Pocket Size)
 - Hook Switch
 - Dial Pulsing
 - Ground Start
 - Ringing Injection
- Instrumentation
 - Multiplexers
 - Data Acquisition
 - Electronic Switching
 - I/O Subsystems
 - Meters (Watt-Hour, Water, Gas)
- Medical Equipment-Patient/Equipment Isolation
- Security
- Aerospace
- Industrial Controls

Description

The CPC1150N is a miniature single-pole, normally open (1-Form-B) solid state relay that uses optically coupled MOSFET technology to provide 1500V_{rms} of input to output isolation. The efficient MOSFET switches and photovoltaic die use Clare's patented OptoMOS architecture while the optically coupled output is controlled by a highly efficient GaAIAs infrared LED.

Clare's state of the art double-molded vertical construction packaging enables the CPC1150N to be one of the world's smallest 4-pin solid state relays. It offers board space savings over the competitor's larger 4-pin SOP relay.

Approvals

- UL 1577 Approved Component: File E76270
- CSA Certified Component: Certificate 1172007
- EN 60950 Certified Component:
TUV Certificate B 10 05 49410 006

Ordering Information

Part #	Description
CPC1150N	4-Pin SOP (100/tube)
CPC1150NTR	4-Pin SOP (2000/reel)

Pin Configuration

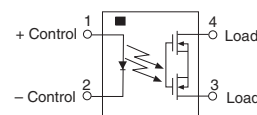

Switching Characteristics of Normally Closed Devices

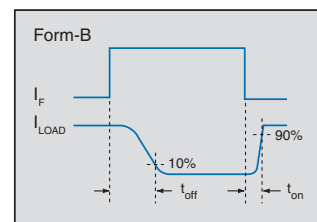

Absolute Maximum Ratings @ 25°C

Parameter	Ratings	Units
Blocking Voltage	350	V _P
Reverse Input Voltage	5	V
Input Control Current Peak (10ms)	50	mA
	1	A
Input Power Dissipation	70	mW
Total Power Dissipation ¹	400	mW
Isolation Voltage, Input to Output	1500	V _{rms}
Operational Temperature	-40 to +85	°C
Storage Temperature	-40 to +125	°C

¹ Derate linearly 3.33 mW / °C

Absolute Maximum Ratings are stress ratings. Stresses in excess of these ratings can cause permanent damage to the device. Functional operation of the device at conditions beyond those indicated in the operational sections of this data sheet is not implied.

Electrical Characteristics @ 25°C

Parameter	Conditions	Symbol	Min	Typ	Max	Units
Output Characteristics						
Load Current Continuous ¹	-	I _L	-	-	120	mA
	t = 10ms	I _{LPK}	-	-	350	
On-Resistance	I _L =120mA	R _{ON}	-	-	50	Ω
Off-State Leakage Current	I _F =2mA, V _L =350V _P	I _{LEAK}	-	-	5	μA
Switching Speeds Turn-On	I _F =5mA, V _L =10V	t _{on}	-	-	1	ms
		t _{off}	-	-	2	
Output Capacitance	I _F =2mA, V _L =50V, f=1MHz	C _{OUT}	-	25	-	pF
Input Characteristics						
Input Control Current ²	I _L =120mA	I _F	-	0.6	2	mA
Input Dropout Current	-	I _F	0.3	0.55	-	mA
Input Voltage Drop	I _F =5mA	V _F	0.9	1.2	1.4	V
Reverse Input Current	V _R =5V	I _R	-	-	10	μA
Common Characteristics						
Capacitance, Input to Output	-	C _{IO}	-	1	-	pF

¹ Load current derates linearly from 120mA @ 25°C to 85mA @ 85°C.

² For applications requiring high temperature operation (greater than 60°C) a LED drive current of 4mA is recommended.

PERFORMANCE DATA*

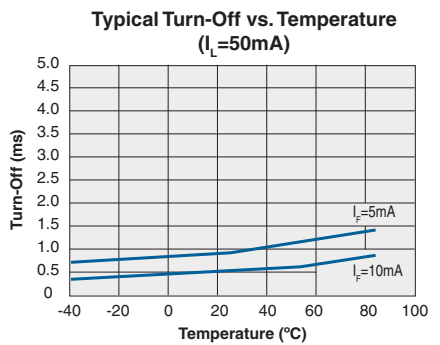
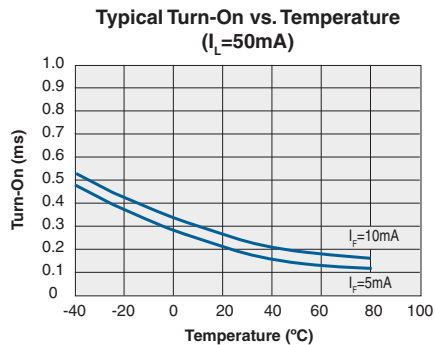
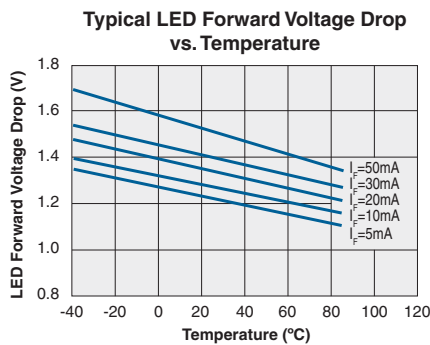
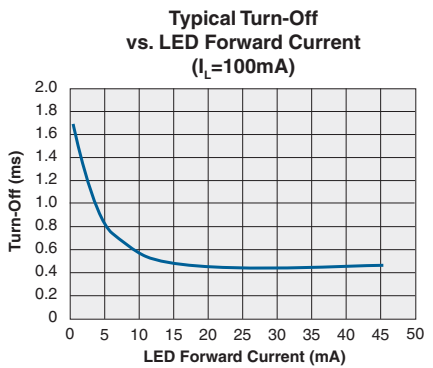
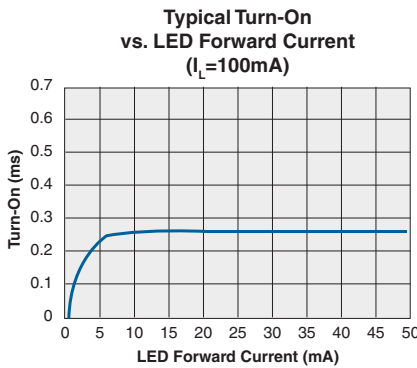
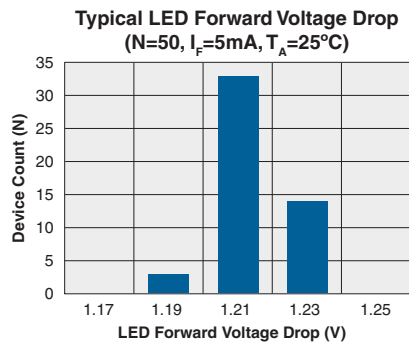
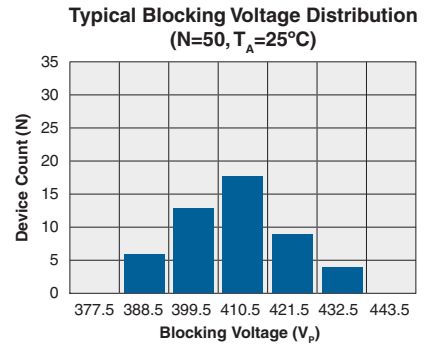
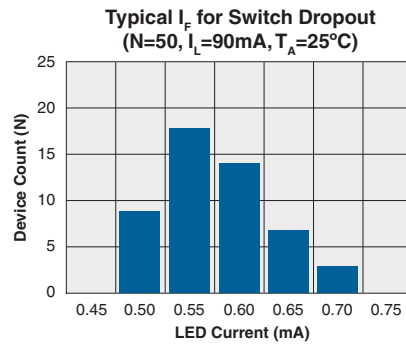
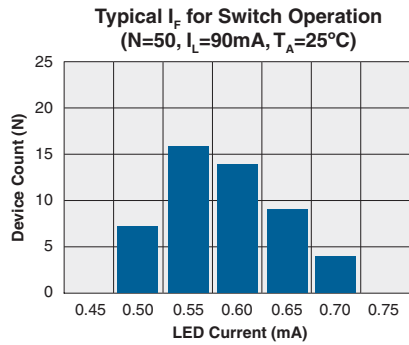
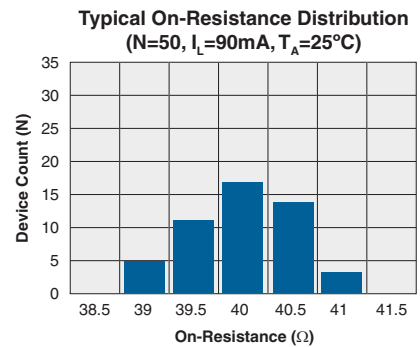
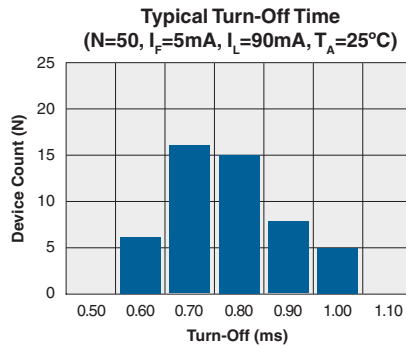
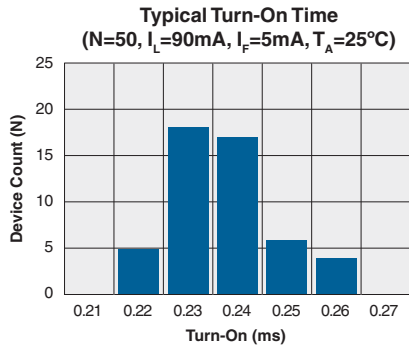

*The Performance data shown in the graphs above is typical of device performance. For guaranteed parameters not indicated in the written specifications, please contact our application department.

PERFORMANCE DATA*

Typical I_F for Switch Operation vs. Temperature ($I_L=50\text{mA}$)

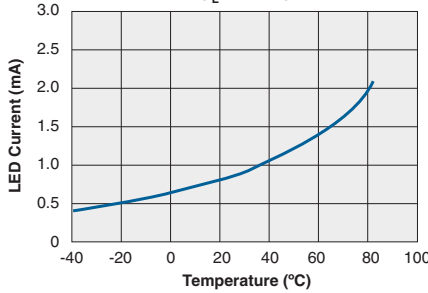

Typical On-Resistance vs. Temperature ($I_F=0\text{mA}$, $I_L=\text{Max Rated}$)

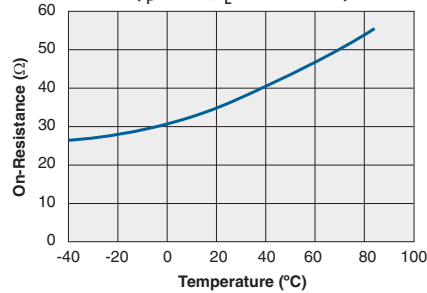

Typical Load Current vs. Load Voltage ($I_F=0\text{mA}$, $T_A=25^\circ\text{C}$)

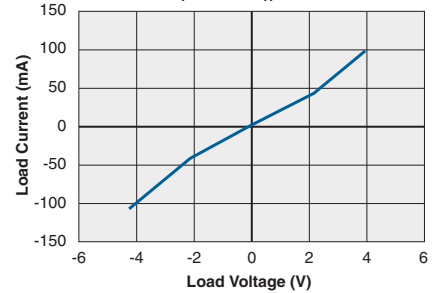

Typical Load Current vs. Temperature ($I_F=0\text{mA}$)

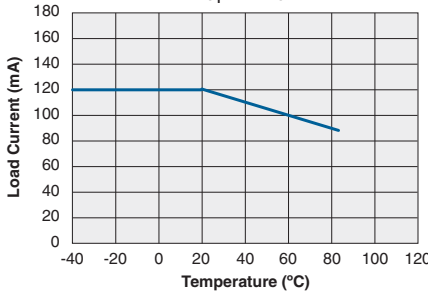

Typical Blocking Voltage vs. Temperature

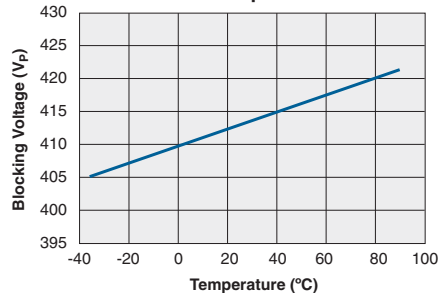

Typical Leakage vs. Temperature Measured Across Pins 3&4 ($V_L=350\text{V}$)

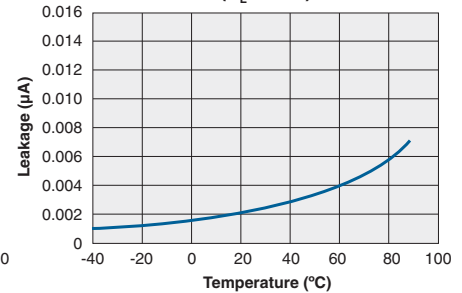

Energy Rating Curve

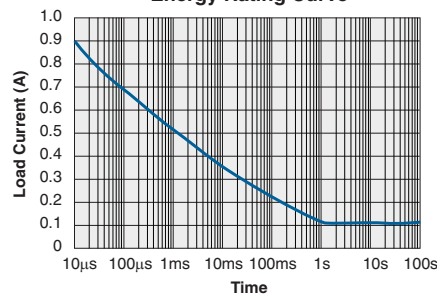

*The Performance data shown in the graphs above is typical of device performance. For guaranteed parameters not indicated in the written specifications, please contact our application department.

Manufacturing Information

Moisture Sensitivity



All plastic encapsulated semiconductor packages are susceptible to moisture ingress. Clare classified all of its plastic encapsulated devices for moisture sensitivity according to the latest version of the joint industry standard, **IPC/JEDEC J-STD-020**, in force at the time of product evaluation. We test all of our products to the maximum conditions set forth in the standard, and guarantee proper operation of our devices when handled according to the limitations and information in that standard as well as to any limitations set forth in the information or standards referenced below.

Failure to adhere to the warnings or limitations as established by the listed specifications could result in reduced product performance, reduction of operable life, and/or reduction of overall reliability.

This product carries a **Moisture Sensitivity Level (MSL) rating** as shown below, and should be handled according to the requirements of the latest version of the joint industry standard **IPC/JEDEC J-STD-033**.

Device	Moisture Sensitivity Level (MSL) Rating
CPC1150N	MSL 3

ESD Sensitivity



This product is **ESD Sensitive**, and should be handled according to the industry standard **JESD-625**.

Reflow Profile

This product has a maximum body temperature and time rating as shown below. All other guidelines of **J-STD-020** must be observed.

Device	Maximum Temperature x Time
CPC1150N	260°C for 30 seconds

Board Wash

Clare recommends the use of no-clean flux formulations. However, board washing to remove flux residue is acceptable. Since Clare employs the use of silicone coating as an optical waveguide in many of its optically isolated products, the use of a short drying bake could be necessary if a wash is used after solder reflow processes. Chlorine- or Fluorine-based solvents or fluxes should not be used. Cleaning methods that employ ultrasonic energy should not be used.



MECHANICAL DIMENSIONS

CPC1150N

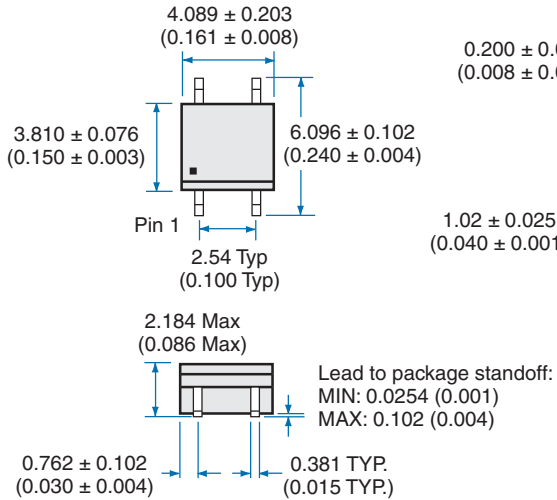

Recommended PCB Land Pattern

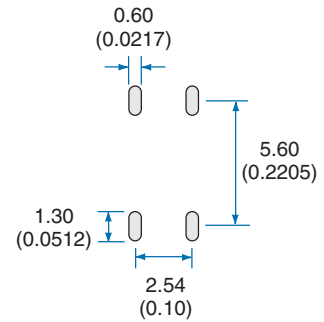

Dimensions
mm
(inches)

CPC1150N Tape & Reel

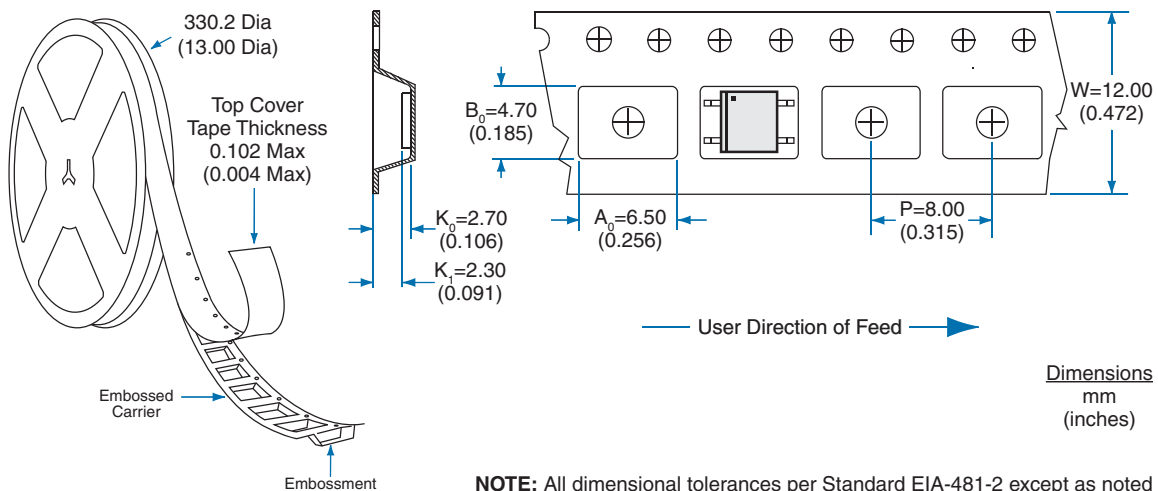

NOTE: All dimensional tolerances per Standard EIA-481-2 except as noted

For additional information please visit our website at: www.clare.com

Clare, Inc. makes no representations or warranties with respect to the accuracy or completeness of the contents of this publication and reserves the right to make changes to specifications and product descriptions at any time without notice. Neither circuit patent licenses nor indemnity are expressed or implied. Except as set forth in Clare's Standard Terms and Conditions of Sale, Clare, Inc. assumes no liability whatsoever, and disclaims any express or implied warranty, relating to its products including, but not limited to, the implied warranty of merchantability, fitness for a particular purpose, or infringement of any intellectual property right.

The products described in this document are not designed, intended, authorized or warranted for use as components in systems intended for surgical implant into the body, or in other applications intended to support or sustain life, or where malfunction of Clare's product may result in direct physical harm, injury, or death to a person or severe property or environmental damage. Clare, Inc. reserves the right to discontinue or make changes to its products at any time without notice.

Specification: DS-CPC1150N-R07
©Copyright 2010, Clare, Inc.
OptoMOS® is a registered trademark of Clare, Inc.
All rights reserved. Printed in USA.
10/18/2010