



# CLARE

# CPC1008N 4 Pin SOP OptoMOS® Relay



|                     | CPC1008N | Units |
|---------------------|----------|-------|
| Load Voltage        | 100      | V     |
| Load Current        | 150      | mA    |
| Max R <sub>ON</sub> | 8        | Ω     |

### Features

- Small 4 Pin SOP Package
- Low Drive Power Requirements (TTL/CMOS Compatible)
- No Moving Parts
- High Reliability
- Arc-Free With No Snubbing Circuits
- 1500V<sub>RMS</sub> Input/Output Isolation
- No EMI/RFI Generation
- Machine Insertable, Wave Solderable
- Tape & Reel Version Available

### Applications

- Instrumentation
  - Multiplexers
  - Data Acquisition
  - Electronic Switching
  - I/O Subsystems
  - Meters (Watt-Hour, Water, Gas)
- Medical Equipment—Patient/Equipment Isolation
- Security Systems
- Aerospace
- Industrial Controls
- Reed Relay Replacement

### Description

CPC1008N is a miniature low voltage, low on resistance 1-Form-A solid state relay in a 4 pin SOP package. The relay uses optically coupled MOSFET technology to provide 1500V of input to output isolation. The efficient MOSFET switches and photovoltaic die use Clare's patented OptoMOS® architecture. The optically-coupled input is controlled by a highly efficient GaAlAs infrared LED. The CPC1008N uses Clare's state of the art double molded vertical construction packaging to produce the world's smallest relay. The CPC1008N is ideal for replacing larger less reliable reed and electromechanical relays.

### Approvals

- UL Recognized Component  
File #: E76270
- Certified to: EN60950

### Ordering Information

| Part #     | Description            |
|------------|------------------------|
| CPC1008N   | 4 Pin SOP (100/tube)   |
| CPC1008NTR | 4 Pin SOP (2,000/reel) |

### Pin Configuration

CPC1008N Pinout

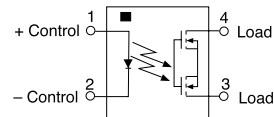

### Switching Characteristics of Normally Open (Form A) Devices

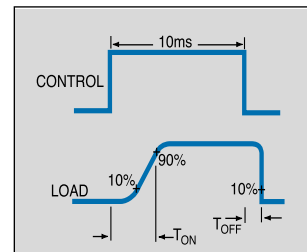

**Absolute Maximum Ratings (@ 25° C)**

| Parameter                                  | Min  | Typ | Max              | Units            |
|--------------------------------------------|------|-----|------------------|------------------|
| Input Power Dissipation                    | -    | -   | 70               | mW               |
| Input Control Current                      | -    | -   | 50               | mA               |
| Peak (10ms)                                | -    | -   | 1                | A                |
| Reverse Input Voltage                      | -    | -   | 5                | V                |
| Total Power Dissipation                    | -    | -   | 400 <sup>1</sup> | mW               |
| Capacitance                                |      |     |                  |                  |
| Input to Output                            | -    | 1   | -                | pF               |
| Isolation Voltage                          |      |     |                  |                  |
| Input to Output                            | 1500 | -   | -                | V <sub>RMS</sub> |
| Operational Temperature                    | -40  | -   | +85              | °C               |
| Storage Temperature                        | -40  | -   | +125             | °C               |
| Soldering Temperature<br>(10 Seconds Max.) | -    | -   | +220             | °C               |

<sup>1</sup> Derate Linearly 3.33 mw / °C

*Absolute Maximum Ratings are stress ratings. Stresses in excess of these ratings can cause permanent damage to the device. Functional operation of the device at these or any other conditions beyond those indicated in the operational sections of this data sheet is not implied. Exposure of the device to the absolute maximum ratings for an extended period may degrade the device and effect its reliability.*

**Electrical Characteristics**

| Parameter                              | Conditions                               | Symbol            | Min | Typ | Max | Units |
|----------------------------------------|------------------------------------------|-------------------|-----|-----|-----|-------|
| <b>Output Characteristics @ 25°C</b>   |                                          |                   |     |     |     |       |
| Load Voltage (Peak)                    | -                                        | V <sub>L</sub>    | -   | -   | 100 | V     |
| Load Current (Continuous) <sup>1</sup> |                                          | I <sub>L</sub>    | -   | -   | 150 | mA    |
| Peak Load Current                      | 10ms                                     | I <sub>LPK</sub>  | -   | -   | 350 | mA    |
| On-Resistance <sup>2</sup>             | I <sub>L</sub> =150mA                    | R <sub>ON</sub>   | -   | -   | 8   | Ω     |
| Off-State Leakage Current              | V <sub>L</sub> =100V                     | I <sub>LEAK</sub> | -   | -   | 1   | μA    |
| Switching Speeds                       |                                          |                   |     |     |     |       |
| Turn-On                                | I <sub>F</sub> =5mA, V <sub>L</sub> =10V | T <sub>ON</sub>   | -   | -   | 2   | ms    |
| Turn-Off                               | I <sub>F</sub> =5mA, V <sub>L</sub> =10V | T <sub>OFF</sub>  | -   | -   | 0.5 | ms    |
| Output Capacitance                     | 50V; f=1MHz                              | C <sub>OUT</sub>  | -   | 25  | -   | pF    |
| <b>Input Characteristics @ 25°C</b>    |                                          |                   |     |     |     |       |
| Input Control Current                  | I <sub>L</sub> =150mA                    | I <sub>F</sub>    | 2   | -   | 50  | mA    |
| Input Dropout Current                  | -                                        | I <sub>F</sub>    | 0.3 | 0.9 | -   | mA    |
| Input Voltage Drop                     | I <sub>F</sub> =5mA                      | V <sub>F</sub>    | 0.9 | 1.2 | 1.4 | V     |
| Reverse Input Voltage                  | -                                        | V <sub>R</sub>    | -   | -   | 5   | V     |
| Reverse Input Current                  | V <sub>R</sub> =5V                       | I <sub>R</sub>    | -   | -   | 10  | μA    |

<sup>1</sup> Load current derates linearly from 150mA @ 25°C to 120mA @ 85°C.

<sup>2</sup> Measurement taken within 1 second of on time.

PERFORMANCE DATA\*

**CPC1008N**  
Typical LED Forward Voltage Drop  
(Ambient Temperature = 25°C)  
 $I_F = 5\text{mA}$

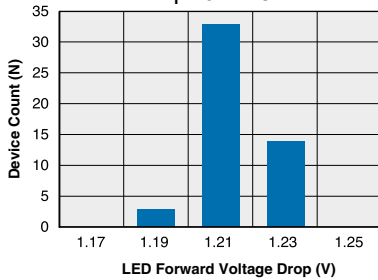

**CPC1008N**  
Typical On-Resistance Distribution  
(Ambient Temperature = 25°C)  
(Load Current = 150mA)

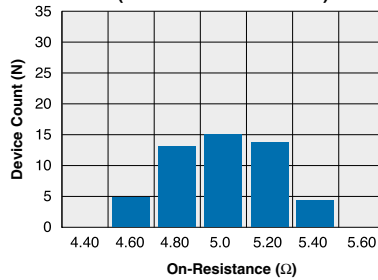

**CPC1008N**  
Typical Blocking Voltage Distribution  
(Ambient Temperature = 25°C)

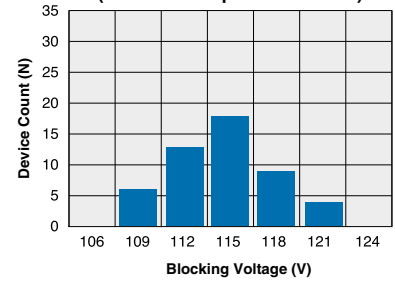

**CPC1008N**  
Typical  $I_F$  for Switch Operation  
(Ambient Temperature = 25°C)  
(Load Current = 100mA)

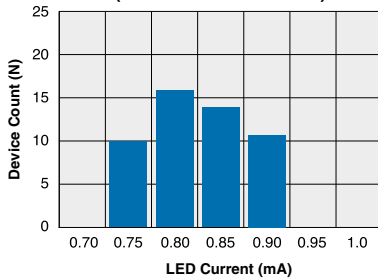

**CPC1008N**  
Typical  $I_F$  for Switch Dropout  
(Ambient Temperature = 25°C)  
(Load Current = 100mA)

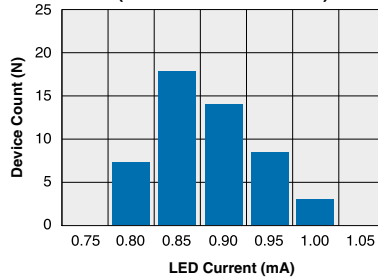

**CPC1008N**  
Typical Turn-On Time  
(Ambient Temperature = 25°C)  
(Load Current = 150mA;  $I_F = 5\text{mA}$ )

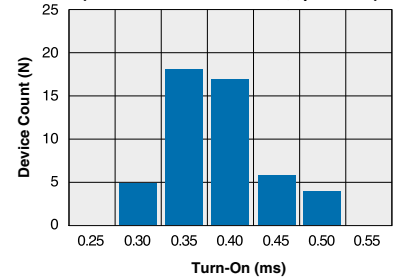

**CPC1008N**  
Typical Turn-Off Time  
(Ambient Temperature = 25°C)  
(Load Current = 150mA;  $I_F = 5\text{mA}$ )

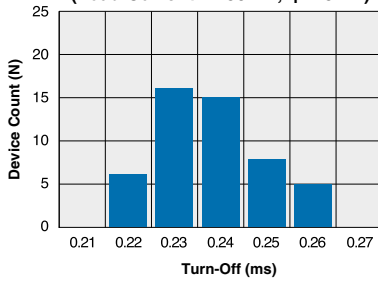

**CPC1008N**  
Typical Maximum Load Current vs. Temperature

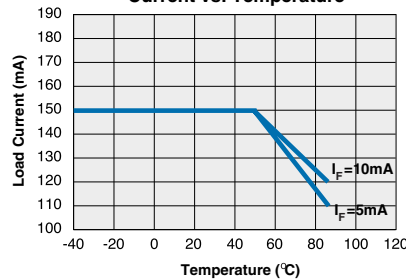

**CPC1008N**  
Typical Leakage vs. Temperature  
(Measured across Pins 3 & 4)  $I_L = \text{max rated}$

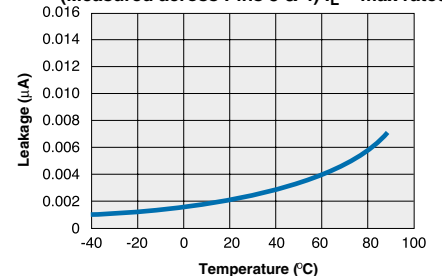

**CPC1008N**  
Typical Blocking Voltage vs. Temperature

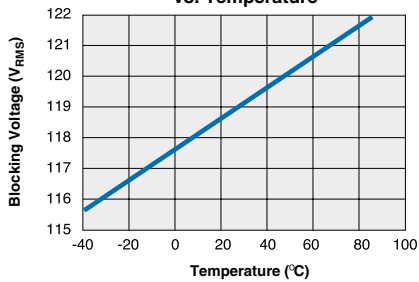

**CPC1008N**  
Typical Turn-On vs. Temperature  
(Load Current = 100mA)

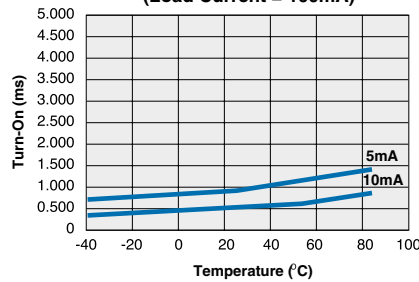

**CPC1008N**  
Typical Turn-Off vs. Temperature  
(Load Current = 100mA)

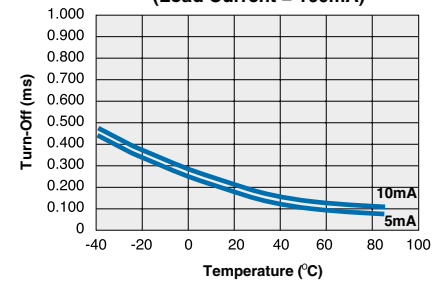

\*The Performance data shown in the graphs above is typical of device performance. For guaranteed parameters not indicated in the written specifications, please contact our application department.

PERFORMANCE DATA\*

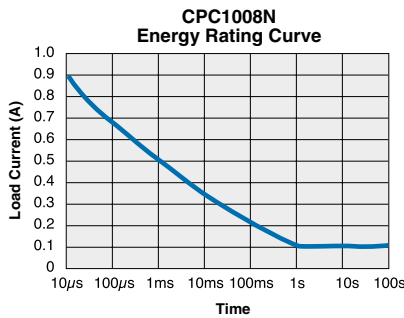
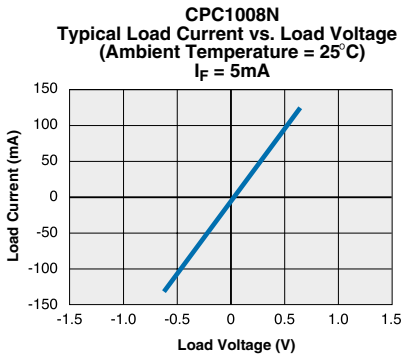
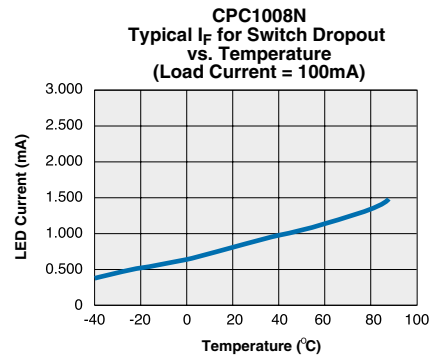
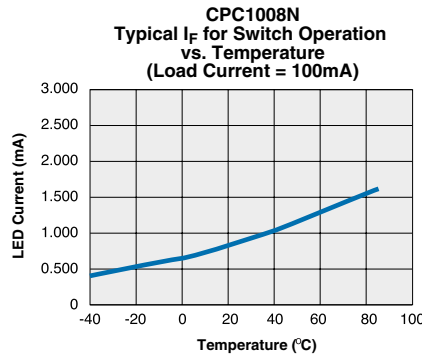
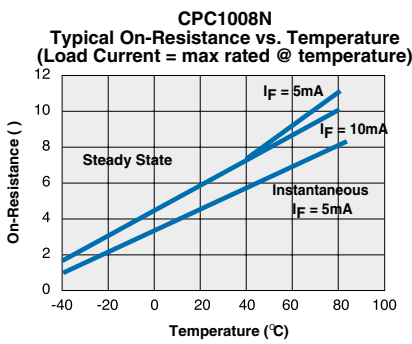
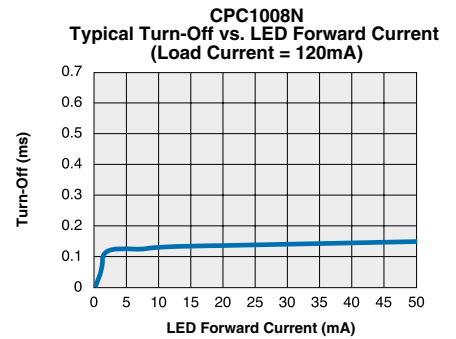
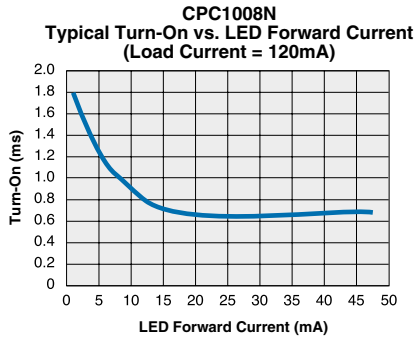
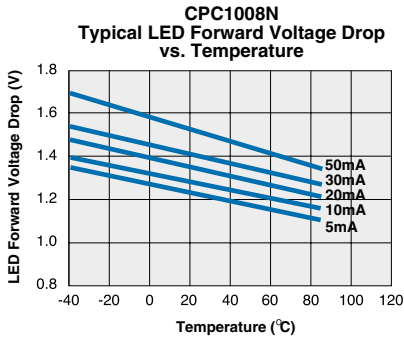

\*The Performance data shown in the graphs above is typical of device performance. For guaranteed parameters not indicated in the written specifications, please contact our application department.

MECHANICAL DIMENSIONS

4 Pin SOIC Narrow ("N" Suffix)

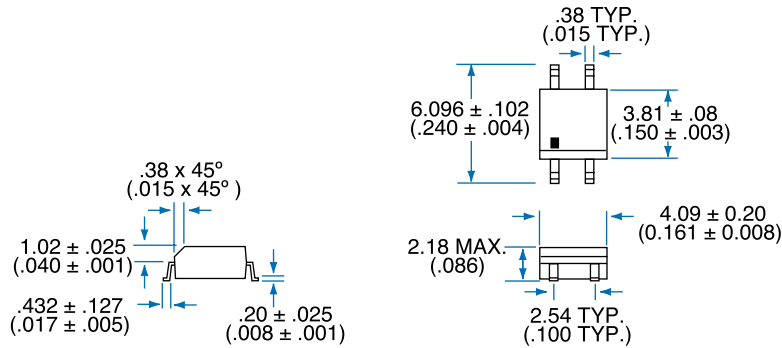

PC Board Pattern (Top View)

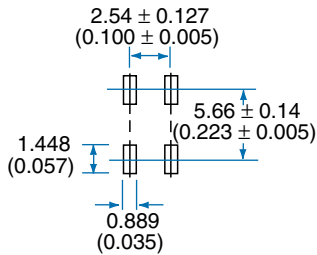

Tape and Reel Packaging for 4 pin SOIC package

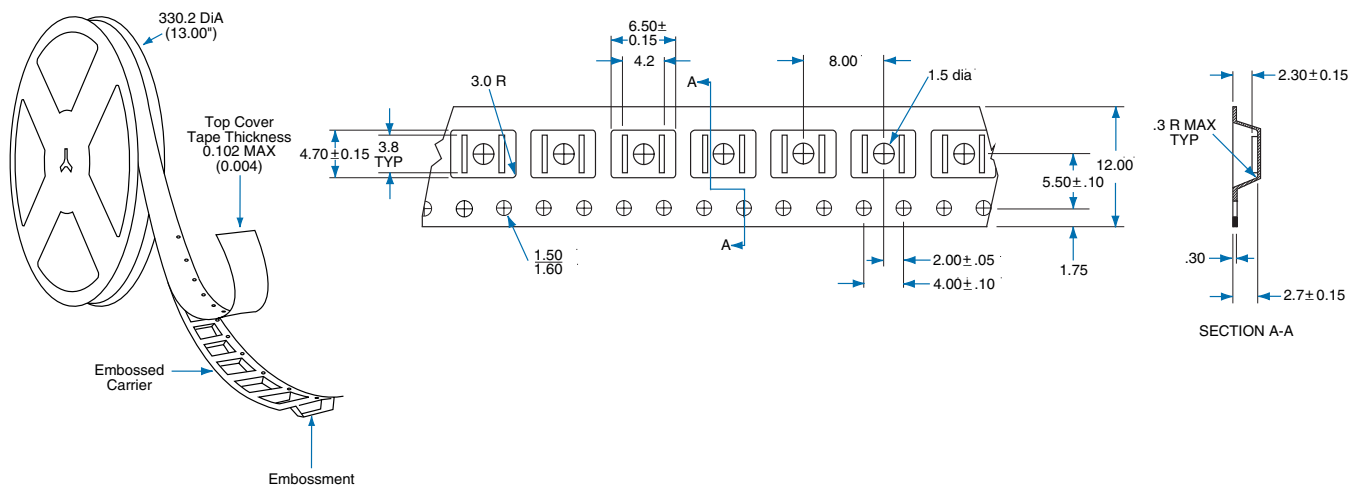

Dimensions  
mm  
(inches)



# CLARE

---

**For additional information please visit our website at: [www.clare.com](http://www.clare.com)**

*Clare, Inc. makes no representations or warranties with respect to the accuracy or completeness of the contents of this publication and reserves the right to make changes to specifications and product descriptions at any time without notice. Neither circuit patent licenses nor indemnity are expressed or implied. Except as set forth in Clare's Standard Terms and Conditions of Sale, Clare, Inc. assumes no liability whatsoever, and disclaims any express or implied warranty, relating to its products including, but not limited to, the implied warranty of merchantability, fitness for a particular purpose, or infringement of any intellectual property right.*

*The products described in this document are not designed, intended, authorized or warranted for use as components in systems intended for surgical implant into the body, or in other applications intended to support or sustain life, or where malfunction of Clare's product may result in direct physical harm, injury, or death to a person or severe property or environmental damage. Clare, Inc. reserves the right to discontinue or make changes to its products at any time without notice.*

Specification: DS-CPC1008N-R2.0  
©Copyright 2001, Clare, Inc.  
OptoMOS® is a registered trademark of Clare, Inc.  
All rights reserved. Printed in USA.  
1/9/02