

New

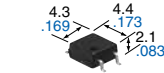

mm inch

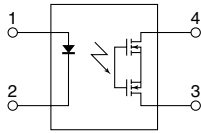

Compliance with RoHS Directive

FEATURES

1. High sensitivity (Low current-consumption)

HS type PhotoMOS relays need less than half LED forward current of other types. This contributes to energy-saving working of equipment and longer operating life for battery.

Sensitivity comparison between HS type and GU type

In case of load voltage 60V type, SOP4-pin

		HS type (AQY232S)	GU type (AQY212S)
LED operate current	Typical	0.35 mA	0.9 mA
	Maximum	0.5 mA	3 mA
Recommended LED forward current		2 mA	5 mA

- 2. Small package (SOP4-pin)
- 3. 60 V, 350 V and 400 V load voltage types available

TYPICAL APPLICATIONS

Ideal for battery-powered devices that need to lengthen operating life. Also recommended for power-economizing of testing equipment that uses many relays.

1. Security equipment
 - Crime-preventing system: Surveillance camera, burglar alarm
 - Disaster-preventing system: Fire alarm, heat/smoke sensor
2. Measuring instruments
3. Meters (watt-hour, gas, etc.)
4. Telecommunication equipment
5. Industrial equipment

TYPES

	Output rating*		Package	Part No.			Packing quantity	
	Load voltage	Load current		Tube packing style	Tape and reel packing style		Tube	Tape and reel
					Picked from the 1/2-pin side	Picked from the 3/4-pin side		
AC/DC dual use	60V	500mA	SOP4-pin	AQY232S	AQY232SX	AQY232SZ	1 tube contains: 100 pcs. 1 batch contains: 2,000 pcs.	1,000 pcs.
	350V	120mA		AQY230S	AQY230SX	AQY230SZ		
	400V	100mA		AQY234S	AQY234SX	AQY234SZ		

Note: For space reasons, the three initial letters of the part number "AQY", the surface mount terminal indicator "S" and the packing style indicator "X" or "Z" are not marked on the relay. (Ex. the label for product number AQY232SX is 232.)

* Indicate the peak AC and DC values.

Ratings and packages other than those given above are available by special order. Please contact our sales office in your area.

RATING

1. Absolute maximum ratings (Ambient temperature: 25°C 77°F)

Item		Symbol	AQY232S	AQY230S	AQY234S	Remarks
Input	LED forward current	I _F	50 mA			
	LED reverse voltage	V _R	5 V			
	Peak forward current	I _{FP}	1 A			f = 100 Hz, Duty factor = 0.1%
	Power dissipation	P _{in}	75 mW			
Output	Load voltage (peak AC)	V _L	60 V	350 V	400 V	
	Continuous load current	I _L	0.5 A	0.12 A	0.1 A	Peak AC, DC
	Peak load current	I _{peak}	1.5 A	0.3 A	0.24 A	100ms (1 shot), V _L = DC
	Power dissipation	P _{out}	300 mW			
Total power dissipation		P _T	350 mW			
I/O isolation voltage		V _{iso}	1,500 V AC			
Operating temperature		T _{opr}	-40°C to +85°C -40°F to +185°F			Non-condensing at low temperatures
Storage temperature		T _{stg}	-40°C to +100°C -40°F to +212°F			

HS SOP 1 Form A (AQY2)

2. Electrical characteristics (Ambient temperature: 25°C 77°F)

Item			Symbol	AQY232S	AQY230S	AQY234S	Remarks
Input	LED operate current	Typical	I_{Fon}	0.35 mA			$\Delta I_F/\Delta t \geq \text{Min. } 100 \mu\text{A/s}$ $I_L = \text{Max.}$
		Maximum		0.5 mA			
	LED turn off current	Minimum	I_{Foff}	0.1 mA			$\Delta I_F/\Delta t \geq \text{Min. } 100 \mu\text{A/s}$ $I_L = \text{Max.}$
		Typical		0.3 mA			
LED dropout voltage	Typical	V_F	1.25 V (1.1 V at $I_F = 2 \text{ mA}$)			$I_F = 50 \text{ mA}$	
	Maximum		1.5 V				
Output	On resistance	Typical	R_{on}	0.85 Ω	19 Ω	27 Ω	$I_F = 2 \text{ mA}$ $I_L = \text{Max.}$ Within 1 s on time
		Maximum		2.5 Ω	25 Ω	35 Ω	
	Off state leakage current	Maximum	I_{Leak}	1 μA			$I_F = 0 \text{ mA}$ $V_L = \text{Max.}$
Transfer characteristics	Turn on time*	Typical	T_{on}	1.5 ms	1.2 ms	0.8 ms	$I_F = 2 \text{ mA}$ $I_L = \text{Max.}$
		Maximum		5 ms			
	Turn off time*	Typical	T_{off}	0.15 ms	0.1 ms	0.1 ms	$I_F = 2 \text{ mA}$ $I_L = \text{Max.}$
		Maximum		2 ms			
	I/O capacitance	Typical	C_{iso}	0.8 pF			$f = 1 \text{ MHz}$ $V_B = 0 \text{ V}$
Maximum		1.5 pF					
Initial I/O isolation resistance	Minimum	R_{iso}	1,000 M Ω			500 V DC	

Note: Please refer to the schematic and wiring diagram for connection method.

*Turn on/Turn off time

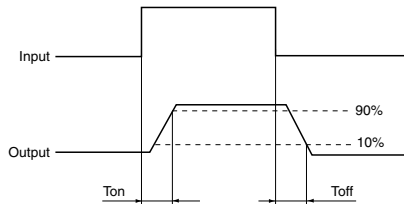

RECOMMENDED OPERATING CONDITIONS

Please obey the following conditions to ensure proper relay operation (turn on) and resetting (turn off).

Item	Symbol	Recommended value	Unit
Input LED current	I_F	2	mA

REFERENCE DATA

1. Load current vs. ambient temperature characteristics

Allowable ambient temperature: -40°C to $+85^\circ\text{C}$
 -40°F to $+185^\circ\text{F}$

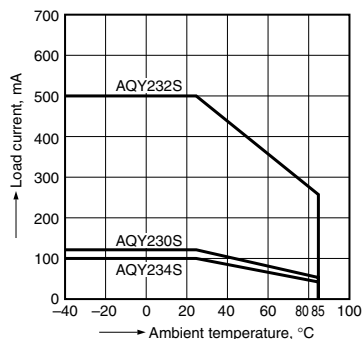

2. On resistance vs. ambient temperature characteristics

Measured portion: between terminals 3 and 4;
LED current: 2 mA; Load voltage: Max. (DC);
Continuous load current: Max. (DC)

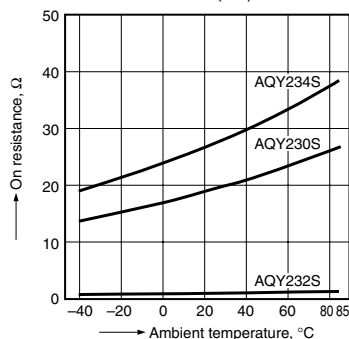

3. Turn on time vs. ambient temperature characteristics

LED current: 2 mA; Load voltage: Max. (DC);
Continuous load current: Max. (DC)

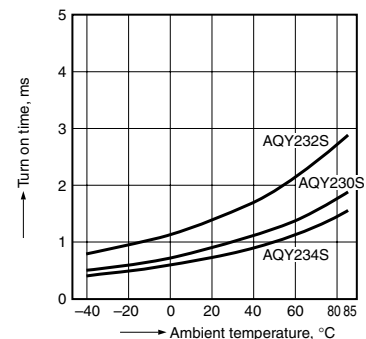

4. Turn off time vs. ambient temperature characteristics

LED current: 2 mA; Load voltage: Max. (DC); Continuous load current: Max. (DC)

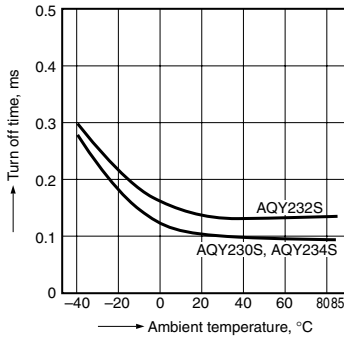

5. LED operate current vs. ambient temperature characteristics

Sample: All types; Load voltage: Max. (DC); Continuous load current: Max. (DC)

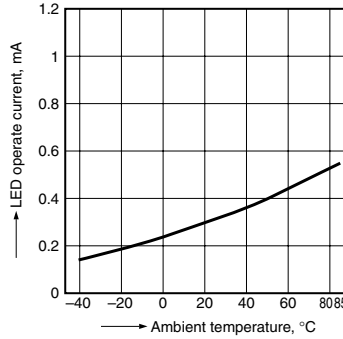

6. LED turn off current vs. ambient temperature characteristics

Sample: All types; Load voltage: Max. (DC); Continuous load current: Max. (DC)

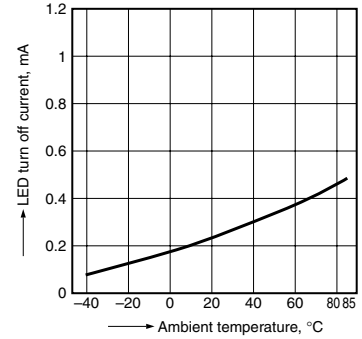

7. LED dropout voltage vs. ambient temperature characteristics

Sample: All types; LED current: 2 to 50 mA

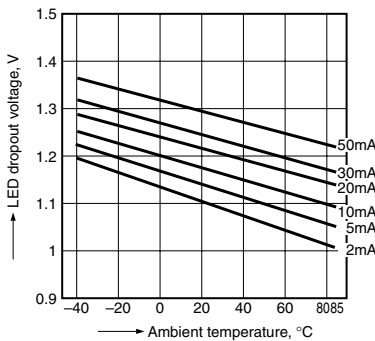

8-(1). Current vs. voltage characteristics of output at MOS portion

Measured portion: between terminals 3 and 4; Ambient temperature: 25°C 77°F

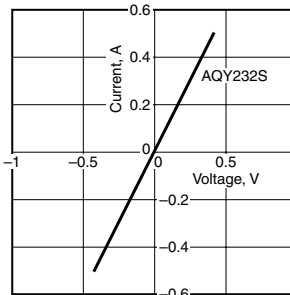

8-(2). Current vs. voltage characteristics of output at MOS portion

Measured portion: between terminals 3 and 4; Ambient temperature: 25°C 77°F

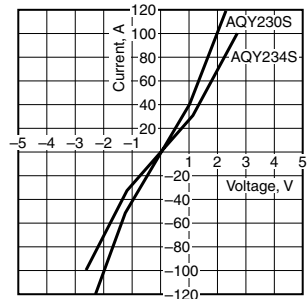

9. Off state leakage current vs. load voltage characteristics

Measured portion: between terminals 3 and 4; Ambient temperature: 25°C 77°F

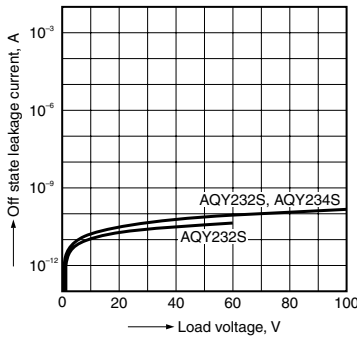

10. Turn on time vs. LED forward current characteristics

Measured portion: between terminals 3 and 4; Load voltage: Max. (DC); Continuous load current: Max. (DC); Ambient temperature: 25°C 77°F

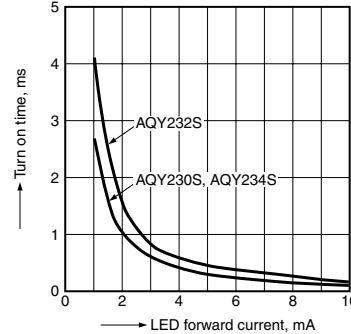

11. Turn off time vs. LED forward current characteristics

Measured portion: between terminals 3 and 4; Load voltage: Max. (DC); Continuous load current: Max. (DC); Ambient temperature: 25°C 77°F

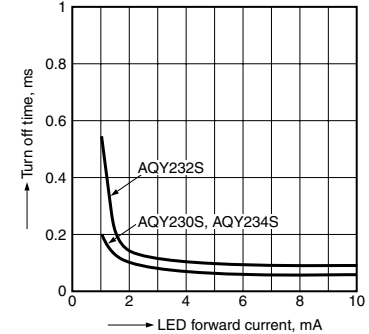

12. Output capacitance vs. applied voltage characteristics

Measured portion: between terminals 3 and 4; Frequency: 1 MHz (30 mVrms); Ambient temperature: 25°C 77°F

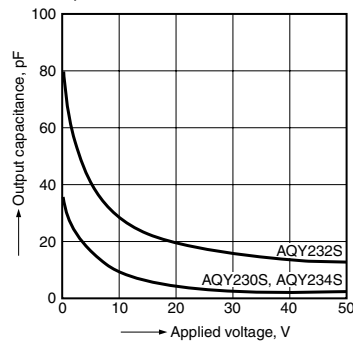

HS SOP 1 Form A (AQY2)

DIMENSIONS (Unit: mm inch)



External dimensions

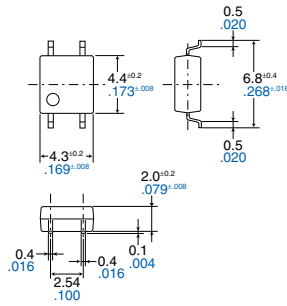

Terminal thickness $t = \pm 0.15 \pm .006$
 General tolerance: $\pm 0.1 \pm .004$

Recommended mounting pad (Top view)

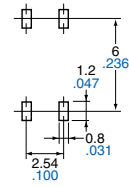

Tolerance: $\pm 0.1 \pm .004$

SCHEMATIC AND WIRING DIAGRAMS

E_1 : Power source at input side; I_F : LED forward current; V_L : Load voltage; I_L : Load current

Schematic	Output configuration	Load	Wiring diagram
	1a	AC/DC	

PhotoMOS RELAYS CAUTIONS FOR USE

SAFETY WARNINGS

- Do not use the product under conditions that exceed the range of its specifications. It may cause overheating, smoke, or fire.
- Do not touch the recharging unit while the power is on. There is a danger of electrical shock. Be sure to turn off the power when performing mounting, maintenance, or repair operations on the relay (including connecting parts such as the terminal board and socket).
- Check the connection diagrams in the catalog and be sure to connect the terminals correctly. Erroneous connections could lead to unexpected operating errors, overheating, or fire.

1. Applying stress that exceeds the absolute maximum rating

If the voltage or current value for any of the terminals exceeds the absolute maximum rating, internal elements will deteriorate because of the overvoltage or overcurrent. In extreme cases, wiring may melt, or silicon P/N junctions may be destroyed.

Therefore, the circuit should be designed in such a way that the load never exceed the absolute maximum ratings, even momentarily.

2. Derating design

Derating is essential in any reliable design and a significant factor in consideration of product life. Sufficient derating is needed against maximum rating when designing a system. And also, relays should be examined using a measurement equipment. Derated voltages must be considered according to operating and environmental conditions the relay will be subjected to.

3. Short across terminals

Do not short circuit between terminals when relay is energized, since there is possibility of breaking of the internal IC.

4. LED forward input current

Use with an LED forward input current increase and decrease rate, $\Delta I_F / \Delta t$, of at least 100 $\mu A/s$.

5. Ripple in the input power supply

If ripple is present in the input power supply, observe the following:

- For LED operate current at E_{min} , please maintain 2 mA.
- Please make sure for E_{max} is no higher the LED operate current at than 50 mA.

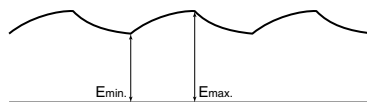

6. Output spike voltages

1) If an inductive load generates spike voltages which exceed the absolute maximum rating, the spike voltage must be limited. Typical circuits are shown below.

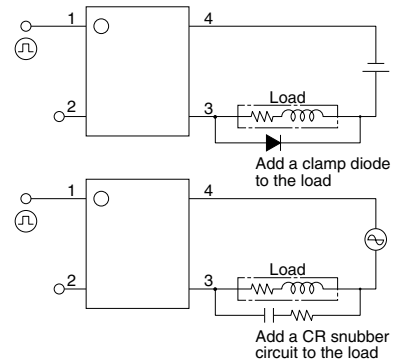

2) Even if spike voltages generated at the load are limited with a clamp diode or snubber circuit if the circuit wires are long, spike voltages will occur by inductance. Keep wires as short as possible to minimize inductance.

7. Cleaning

We recommend cleaning with an organic solvent. If you cannot avoid using ultrasonic cleansing, please ensure that the following conditions are met, and check beforehand for defects.

- Frequency: 27 to 29 kHz
- Ultrasonic output: No greater than 0.25W/cm²
- Cleaning time: No longer than 30 s
- Cleanser used: Asahiklin AK-225
- Other: Submerge in solvent in order to prevent the PC board and elements from being contacted directly by the ultrasonic vibrations.

Note: Applies to unit area ultrasonic output for ultrasonic baths.

8. Notes for mounting

- 1) If many different packages are combined on a single substrate, then lead temperature rise is highly dependent on package size. For this reason, please make sure that the temperature of the terminal solder area of the PhotoMOS relay falls within the temperature conditions of item 10 before mounting.
- 2) If the mounting conditions exceed the recommended solder conditions in item 10, resin strength will fall and the nonconformity of the heat expansion coefficient of each constituent material will increase markedly, possibly causing cracks in the package, severed bonding wires, and the like. For this reason, please inquire with us about whether this use is possible.

3) We recommend cleaning with an organic solvent.

If you cannot avoid using ultrasonic cleaning, check beforehand for defects.

9. Input wiring pattern

With AQY series avoid installing the input (LED side) wiring pattern to the bottom side of the package if you require the specified I/O isolation voltage (V_{iso}) after mounting the PC board. Since part of the frame on the output side is exposed, it may cause fluctuations in the I/O isolation voltage.

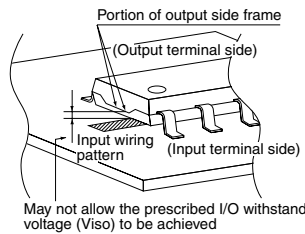

10. Soldering

Example of recommended soldering conditions

(1) IR (Infrared reflow) soldering method

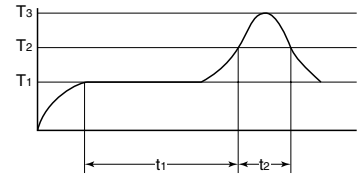

T₁ = 150 to 180°C 302 to 356°F
 T₂ = 230°C 446°F
 T₃ = 245°C 473°F or less
 t₁ = 60 to 120 s or less
 t₂ = 30 s or less

(2) Soldering iron method

Tip temperature: 350 to 400°C 662 to 752°F

Wattage: 30 to 60 W

Soldering time: within 3 s

(3) Others

Check mounting conditions before using other soldering methods (DWS, VPS, hot-air, hot plate, laser, pulse heater, etc.)

- When using lead-free solder, we recommend a type with an alloy composition of Sn 3.0 Ag 0.5 Cu. Please inquire about soldering conditions and other details.
- The temperature profile indicates the temperature of the soldered terminal on the surface of the PC board. The ambient temperature may increase excessively. Check the temperature under mounting conditions.

11. Packing format

1) Tape and reel

mm inch

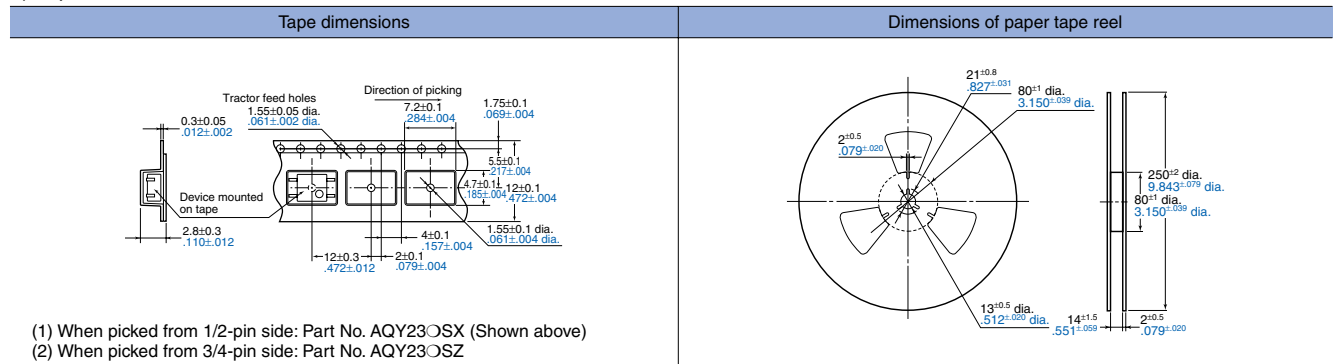

2) Tube

Devices are packaged in a tube so that pin No. 1 is on the stopper B side. Observe correct orientation when mounting them on PC boards.

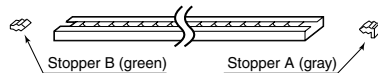

HS SOP 1 Form A (AQY2)

12. Transportation and storage

1) Extreme vibration during transport will warp the lead or damage the relay. Handle the outer and inner boxes with care.

2) Storage under extreme conditions will cause soldering degradation, external appearance defects, and deterioration of the characteristics. The following storage conditions are recommended:

- Temperature: 0 to 45°C **32 to 113°F**
- Humidity: Less than 70% R.H.
- Atmosphere: No harmful gasses such as sulfurous acid gas, minimal dust.

3) Storage method for SOP type PhotoMOS relays implemented in SOP type are sensitive to moisture and come in sealed moisture-proof packages. Observe the following cautions on storage.

- After the moisture-proof package is unsealed, take the devices out of storage as soon as possible (within 1 month, less than 45°C **113°F**/70% R.H.).
- If the devices are to be left in storage for a considerable period after the moisture-proof package has been unsealed, it is recommended to keep them in another moisture-proof bag containing silica gel (within 3 months at the most).