

MOS FET RELAYS

G3VM-21LR10

SSOP Package MOS FET Relay with Low Leakage Current, Output Capacitance and ON Resistance ($C \times R = 2.4 \text{ pF} \cdot \Omega$) in a 20-V Load Voltage Model.

- Output capacitance of 0.8 pF (typical) allows high frequency applications.
- Leakage current of 0.2 nA max. (10 pA typ.) when relay is open
- Turn-on time = 0.026 ms (typ.), turn-off time = 0.045 ms (typ.)
- RoHS compliant

Application Examples

- Semiconductor inspection tools
- Measurement devices and Data loggers
- Broadband systems



NEW

Note: The actual product is marked differently from the image shown here.

List of Models

Contact form	Terminals	Load voltage (peak value)	Model	Number per tape
SPST-NO	Surface-mounting terminals	20 VAC	G3VM-21LR10	---
			G3VM-21LR10(TR05)	500
			G3VM-21LR10(TR)	1,500

Dimensions

Note: All units are in millimeters unless otherwise indicated.

G3VM-21LR10

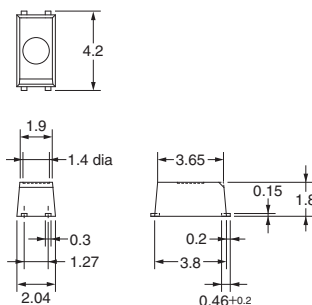

Note: The actual product is marked differently from the image shown here.

Note: A tolerance of ±0.1 mm applies to all dimensions unless otherwise specified.

Weight: 0.03 g

Terminal Arrangement/Internal Connections (Top View)

G3VM-21LR10

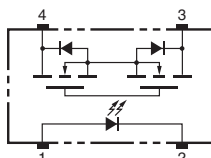

Actual Mounting Pad Dimensions (Recommended Value, Top View)

G3VM-21LR10

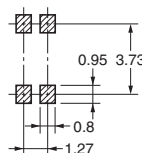

■ Absolute Maximum Ratings (Ta = 25°C)

Item	Symbol	Rating	Unit	Measurement Conditions	
Input	LED forward current	I_F	30	mA	$T_a \geq 25^\circ\text{C}$
	LED forward current reduction rate	$\Delta I_F/^\circ\text{C}$	-0.3	mA/°C	
	LED reverse voltage	V_R	5	V	
	Connection temperature	T_J	125	°C	
Output	Load voltage (AC peak/DC)	V_{OFF}	20	V	$T_a \geq 25^\circ\text{C}$
	Continuous load current	I_O	200	mA	
	ON current reduction rate	$\Delta I_{ON}/^\circ\text{C}$	-2.0	mA/°C	
	Connection temperature	T_J	125	°C	
Dielectric strength between input and output (See note 1.)	V_{I-O}	1,500	V_{rms}	AC for 1 min	
Ambient operating temperature	T_a	-20 to +85	°C	With no icing or condensation	
Storage temperature	T_{stg}	-40 to +125	°C	With no icing or condensation	
Soldering temperature	---	260	°C	10 s	

Note: 1. The dielectric strength between the input and output was checked by applying voltage between all pins as a group on the LED side and all pins as a group on the light-receiving side.

■ Electrical Characteristics (Ta = 25°C)

Item	Symbol	Minimum	Typical	Maximum	Unit	Measurement conditions	
Input	LED forward voltage	V_F	1.15	1.35	1.45	V	$I_F = 5\text{ mA}$
	Reverse current	I_R	---	---	10	μA	$V_R = 5\text{ V}$
	Capacity between terminals	C_T	---	70	---	pF	$V = 0, f = 1\text{ MHz}$
	Trigger LED forward current	I_{FT}	---	---	3	mA	$I_O = 100\text{ mA}$
Output	Maximum resistance with output ON	R_{ON}	---	3	5	Ω	$I_F = 5\text{ mA}, I_O = 200\text{ mA}, t < 1\text{ s}$
	Current leakage when the relay is open	I_{LEAK}	---	10	200	pA	$V_{OFF} = 20\text{ V}, T_a = 25^\circ\text{C}$
	Capacity between terminals	C_{OFF}	---	0.8	1.1	pF	$V = 0, f = 100\text{ MHz}$
Capacity between I/O terminals	C_{I-O}	---	0.3	---	pF	$f = 1\text{ MHz}, V_s = 0\text{ V}$	
Insulation resistance between I/O terminals	R_{I-O}	1,000	---	---	$M\Omega$	$V_{I-O} = 500\text{ VDC}, R_{OH} \leq 60\%$	
Turn-ON time	t_{ON}	---	0.026	0.2	ms	$I_F = 5\text{ mA}, R_L = 200\ \Omega, V_{DD} = 10\text{ V}$ (See note 2.)	
Turn-OFF time	t_{OFF}	---	0.045	0.2	ms		

Note: 2. Turn-ON and Turn-OFF Times

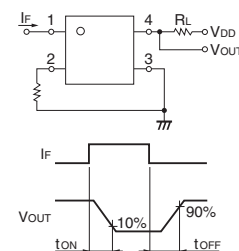

■ Recommended Operating Conditions

Use the G3VM under the following conditions so that the Relay will operate properly.

Item	Symbol	Minimum	Typical	Maximum	Unit
Load voltage (AC peak/DC)	V_{DD}	---	---	20	V
Operating LED forward current	I_F	---	---	20	mA
Continuous load current (AC peak/DC)	I_O	---	---	200	mA
Operating temperature	T_a	25	---	60	°C

■ Engineering Data

LED forward current vs. Ambient temperature

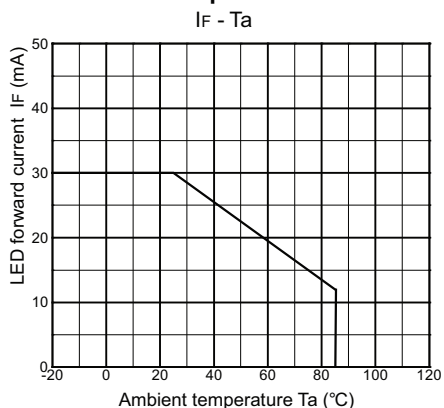

Continuous load current vs. Ambient temperature

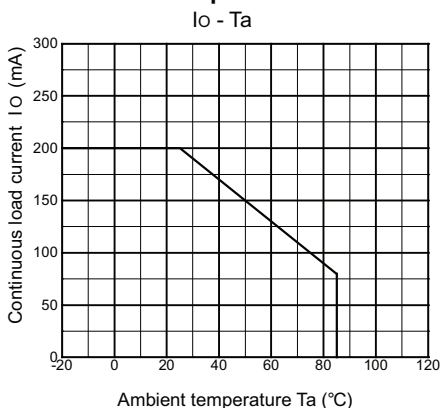

LED forward current vs. LED forward voltage

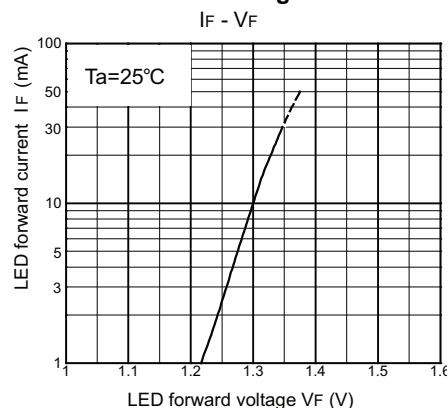

Continuous load current vs. On-state voltage

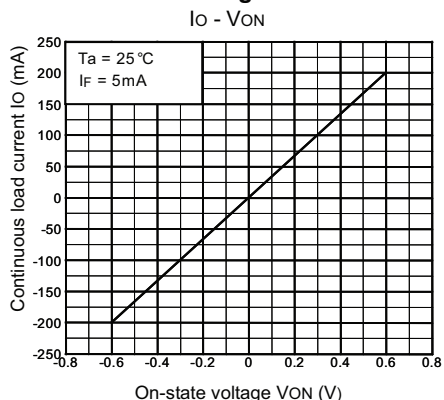

On-state resistance vs. Ambient temperature

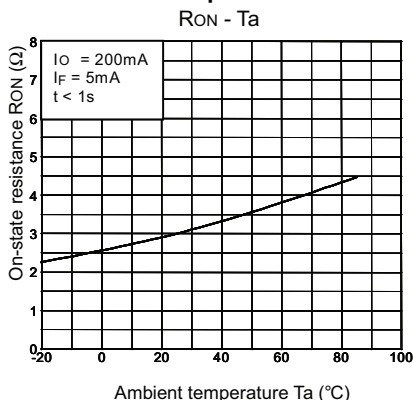

Trigger LED forward current vs. Ambient temperature

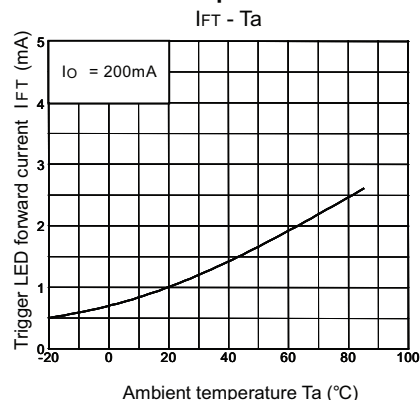

Turn ON, Turn OFF time vs. LED forward current

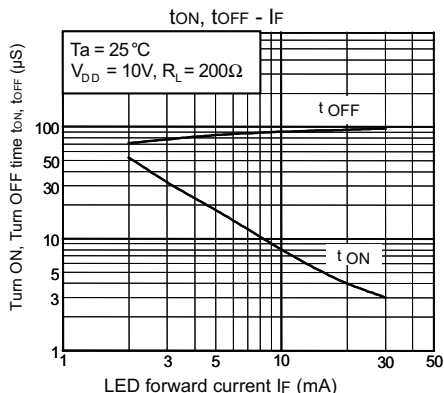

Turn ON, Turn OFF time vs. Ambient temperature

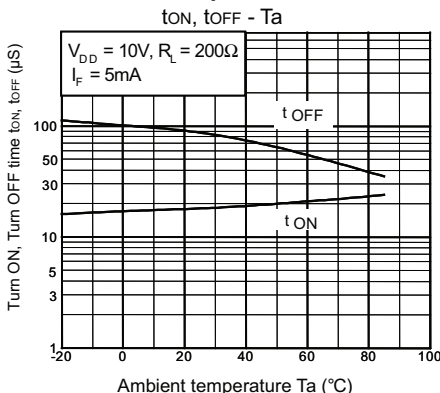

Current leakage vs. Ambient temperature

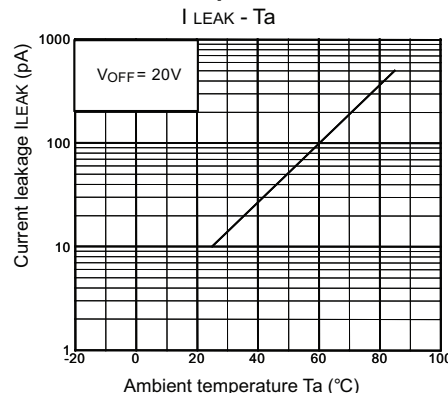

All sales are subject to Omron Electronic Components LLC standard terms and conditions of sale, which can be found at http://www.components.omron.com/components/web/webfiles.nsf/sales_terms.html

ALL DIMENSIONS SHOWN ARE IN MILLIMETERS.
To convert millimeters into inches, multiply by 0.03937. To convert grams into ounces, multiply by 0.03527.

OMRON[®]

**OMRON ELECTRONIC
COMPONENTS LLC**

55 E. Commerce Drive, Suite B
Schaumburg, IL 60173

847-882-2288

OMRON ON-LINE

Global - <http://www.omron.com>

USA - <http://www.components.omron.com>

Cat. No. X302-E-1

12/10

Specifications subject to change without notice

Printed in USA

MOS FET RELAYS **G3VM-21LR10**