

DESCRIPTION

SRC Devices offers a large selection of molded SIP relays to meet customer applications. The DSS4 was developed several years ago and continues to be the relay of choice for hook switch applications in modems and general purpose applications. The SIL4 is the first of a series of new molded products ideally suited for use in high reliability requirements. Its design centers on a new patent pending process aimed at protecting the hermetically sealed reed switch. When properly protected, the reed switch outperforms most other electromechanical switching devices for operating life (at low signal levels), isolation, low resistance and low operating power.

The high performance MVS4 and MSS4 models provide bounce free operation and offer a more durable contact when switching capacitive or inductive loads. Both are capable of switching loads up to 50 watts.

FEATURES

- Patent pending process (SIL4)
- High reliability switching
- 3V operate option available
- Quality defect levels <50 PPM (SIL4)
- Long operating life at low levels (>1 billion operations)
- Capable of switching up to 1000V
- High isolation between input and output (2500V)
- Optional internal diode & N.C. option
- High density board mounting
- Automatic insertion design
- State-of-the-art capsule designs
- Epoxy molded single-in-line package
- FCC68 compatible on MSS4 model

AGENCY APPROVALS

- UL recognized DSS4 model

APPLICATIONS

- ATE
- Functional board testers
- Integrated circuit testers
- Bare board testers
- Telecom
- Matrix requirements
- Instrumentation
- Data acquisition

RATINGS (@ 25° C)

Parameter	Min	Typ	Max	Unit
Switching voltage				
SIL4/DSS4			200	Volts
MSS4			500	Volts
MVS4			1000	Volts
Switching current				
SIL4/DSS4			0.5	Amps
MVS4/MSS4			2	Amps
Carry current				
SIL4			1.5	Amps
DSS4			2	Amps
MSS4/ MVS4			3	Amps
Switching frequency				
SIL4/DSS4			500	Hz
MVS4/MSS4			200	Hz
Contact resistance				
SIL4			120	mΩ
MVS4/MSS4			100	mΩ

(See detailed specifications for more information.)

SPECIFICATIONS

Dry Reed Relay Specifications

All parameters at 25°C unless otherwise stated.
Operate voltage, release voltage, and coil resistance will vary by approximately 0.4%/°C as ambient temperature varies.

SIL4 Instrument-Grade **DSS4** General Purpose

PARAMETER	CONDITIONS	SYMBOL	MIN	TYP	MAX	MIN	TYP	MAX	UNITS
Contact Ratings									
Switching Voltage	Max DC/PeakAC Resistive	V_L	-	-	200	-	-	200	Volts
Switching Current	Max DC/PeakAC Resistive	I_L	-	-	0.5	-	-	0.5	Amps
Carry Current	Max DC/PeakAC Resistive	I_C	-	-	2	-	-	2	Amps
Contact Rating	Max DC/PeakAC Resistive	-	-	-	10	-	-	10	Watts
Life Expectancy	Signal Level 1.0V 10mA Rated Loads ⁽¹⁾	-	-	1000	-	-	500	-	x10 ⁶ Ops
Static Contact Resistance	50mV, 10mA	CR	-	95	120	-	-	150	mΩ
Dynamic Contact Resistance	0.5V, 50mA at 100Hz, 1.5 msec	DCR	-	-	150	-	N/A	N/A	mΩ
Contact Material		-	-	Ru	-	-	Ru	-	-
Relay Specifications									
Insulation Resistance	Between all isolated pins at 100V, 25°C, 40% RH	IR	10 ¹²	10 ¹³	-	10 ¹⁰	10 ¹²	-	Ω
Capacitance	Across Open Contacts	-	-	-	0.8	-	-	1	pF
Open Contact to Coil		-	-	1.2	-	-	-	2	pF
Dielectric Strength	Between Contacts	I/O	250	-	-	250	-	-	VDC/Peak AC
	Contacts to Coil	I/O	2500	-	-	1500	-	-	VDC/Peak AC
Operate Time, including bounce	At Nominal Coil Voltage 10Hz Square Wave	T^{OP}	-	0.2	0.5	-	0.25	0.5	ms
Release Time	Zener-Diode Suppression	T_{REL}	-	0.1	0.5	-	0.15	0.5	-
Environmental Ratings									
Storage Temperature	T	A	-55	-	+125	-40	-	+105	°C
Operating Temperature	T	O	-40	-	+85	-40	-	+85	°C
Soldering Temperature	Applied to pins, 10 sec. max.	-	-	-	+260 ⁽²⁾	-	-	+260	°C
Vibration Resistance ⁽³⁾ (Survival)	5Hz - 2000Hz	G	-	-	20	-	-	20	Gs
Shock Resistance (Survival)	11±1ms, 1/2 Sine Wave	S	-	-	100	-	-	-	-
Weight		-	-	1.8	-	-	1.6	-	grams

⁽¹⁾ Refer to life graphs

⁽²⁾ Capable of surviving infrared solder-reflow process

⁽³⁾ Use caution not to exceed vibration resistance limits while ultrasonically cleaning relays with DYAD switches.
Contact REMtech Engineering for more details/ recommendations

SPECIFICATIONS
Mercury-Wetted Reed Relays

All parameters at 25°C unless otherwise stated.

MVS4
 High Power/Reliability
 Position-Sensitive⁽³⁾
 Hg-Wetted

MSS4
 Non-Position-Sensitive
 Hg-Wetted

PARAMETER	CONDITIONS	SYMBOL	MIN	TYP	MAX	MIN	TYP	MAX	UNITS
Contact Ratings									
Switching Voltage	Max DC/PeakAC Resistive	V_L	-	-	1000 ⁽¹⁾	-	-	500	Volts
Switching Current	Max DC/PeakAC Resistive	I_L	-	-	2	-	-	2	Amps
Carry Current	Max DC/PeakAC Resistive	I_C	-	-	3	-	-	3	Amps
Contact Rating	Max DC/PeakAC Resistive	-	-	-	50 ⁽⁴⁾	-	-	50	Watts
Life Expectancy	Signal Level 1.0V 10mA	-	-	1000	-	-	200	-	x10 ⁶ Ops
	50V, 1A	-	-	2	-	-	-	-	x10 ⁶ Ops
	500V, 100mA	-	-	50	-	-	-	-	x10 ⁶ Ops
	Rated Loads ⁽²⁾	-	-	7	-	-	7	-	x10 ⁶ Ops
Static Contact Resistance	50mV, 10mA	CR	-	-	100	-	-	100	mΩ
Contact Material		-	-	Hg	-	-	Hg	-	
Hg Content		-	-	40	-	-	16	-	mgram
Relay Specifications									
Insulation Resistance	Between all isolated pins at 100V, 25°C, 40% RH	IR	10 ¹⁰	10 ¹²	-	10 ⁸	10 ¹⁰	-	Ω
Capacitance	Across Open Contacts	-	-	0.8	-	-	-	2	pF
	Upper Contact to Coil	-	-	2.2	-	-	-	4	pF
	Closed Contact to Coil	-	-	3.3	-	-	-	-	pF
Dielectric Strength	Between Contacts	I/O	2000	-	-	2000	-	-	VDC/Peak AC
	Contacts to Coil	I/O	2500	-	-	1400	-	-	VDC/Peak AC
Operate Time, no bounce	At Nominal Coil Voltage 10Hz Square Wave	T_{OP}	-	-	2.5	-	-	1.75	ms
Release Time	Zener-Diode Suppression	T_{REL}	-	-	2.5	-	-	1.5	ms
Environmental Ratings									
Storage Temperature	T	T_A	-40	-	+105	-40	-	+105	°C
Operating Temperature	T	T_O	-38	-	+85	-38	-	+75	°C
Soldering Temperature	Applied to pins, 10 sec. max.	-	-	-	+260	-	-	+260	°C
Vibration Resistance (Survival)	10Hz - 500Hz	G	-	-	10	-	-	10	Gs
Shock Resistance (Survival)	11±1ms, 1/2 Sine Wave	S	-	-	30	-	-	30	Gs
Weight		-	-	2.2	-	-	2.4	-	grams

⁽¹⁾ Current limited up to 5mA, typical 20 million operations; for further life information, consult factory.

⁽²⁾ Refer to MH4 (MVS4) & MYAD (MSS4) life graphs.

⁽³⁾ Vertical mounting required. Pin #1 is up.

⁽⁴⁾ Derate to 5 watts when switching voltages >500V.

COIL SPECIFICATIONS

Part #	Contact Form	Coil Voltage			Coil Resistance			Operate Voltage			Release Voltage			Nominal Input Power		
		Min	Typ	Max	Min	Typ	Max	Min	Typ	Max	Min	Typ	Max	Min	Typ	Max
		Volts			Ω			Volts			Volts			mW		
					+/- 10% (25°C)			Must operate by (25°C)			Must release by (25°C)					
		Min	Typ	Max	Min	Typ	Max	Min	Typ	Max	Min	Typ	Max	Min	Typ	Max
SIL41A03(B)	1-Form-A		3	6	135	150	165			2.25	0.3					60
SIL41A05(B)	1-Form-A		5	10	450	500	550			3.75	0.4					50
SIL41A12(B)	1-Form-A		12	16	900	1000	1100			8.6	1.5					144
SIL41A24(B)	1-Form-A		24	30	1800	2000	2200			17.5	2.5					288
SIL41B05(B)	1-Form-B		5	6	450	500	550			3.75	0.8					50
SIL41B12(B)	1-Form-B		12	14	900	1000	1100			9	1.5					144
SIL41B24(B)	1-Form-B		24	29	1800	2000	2200			18	2.5					288
DSS41A05	1-Form-A		5	10	450	500	550			3.75	0.8					50
DSS41A12	1-Form-A		12	16	900	1000	1100			8.6	1.5					144
DSS41A24	1-Form-A		24	30	1800	2000	2200			17.5	2.5					288
DSS41B05	1-Form-B		5	10	450	500	550			3.75	0.8					50
DSS41B12	1-Form-B		12	16	900	1000	1100			9	1					144
DSS41B24	1-Form-B		24	30	1935	2150	2365			18	2					268
MVS41A05(B)	1-Form-A		5	7	94.5	105	116			3.75	0.5					238
MVS41A12(B)	1-Form-A		12	15	450	500	550			9	1					288
MVS41A24(B)	1-Form-A		24	30	1935	2150	2365			18	2.0					268
MSS41A05	1-Form-A		5	10	126	140	154			3.75	0.5					179
MSS41A12	1-Form-A		12	16	450	500	550			9	1					288
MSS41A24	1-Form-A		24	30	1935	2150	2365			18	2					268

MECHANICAL DIMENSIONS

DIMENSIONS
mm
(inches)

SIL4/DSS4

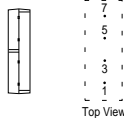
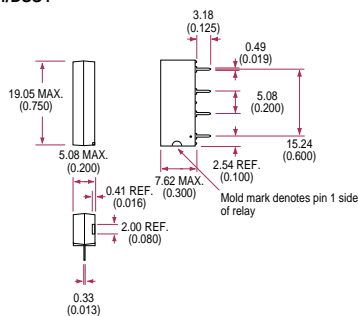

SIL4/DSS4 Pinout

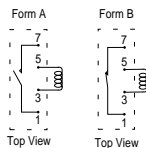

For Form B or diode options, coil polarity (pin #3 positive) must be observed.

MVS4/MSS4

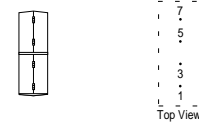
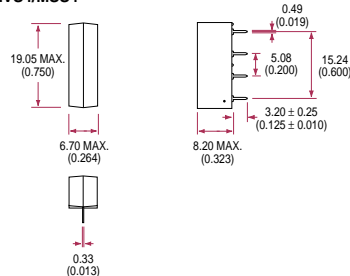

MVS4/MSS4 Pinout

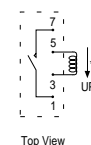

* MVS4 only must be mounted vertically with pin #1 up.

PERFORMANCE GRAPHS

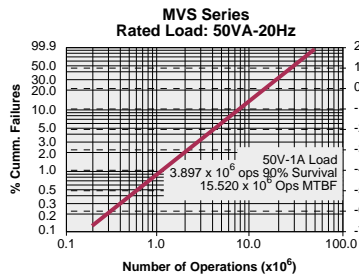
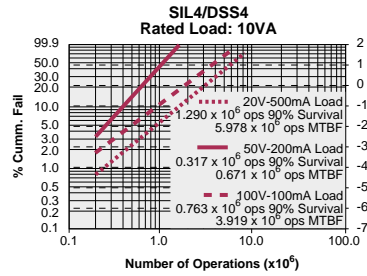
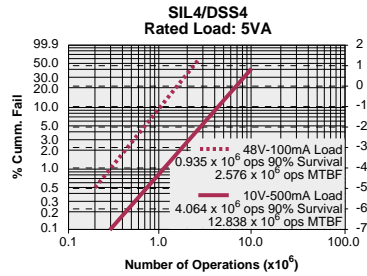

Relay Internal Temperature Rise vs. Power

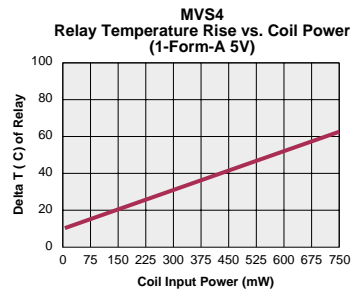
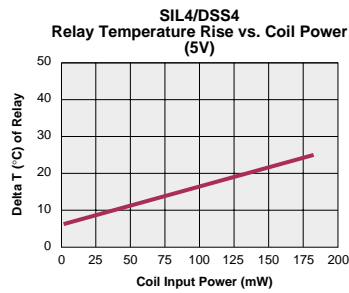

PERFORMANCE GRAPHS

Pull In/Drop Out vs. Temperature

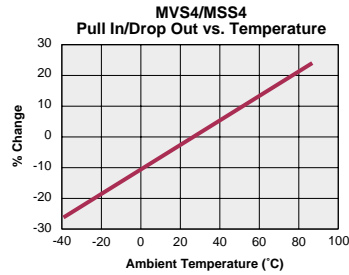

Operate/Release Time Characteristics

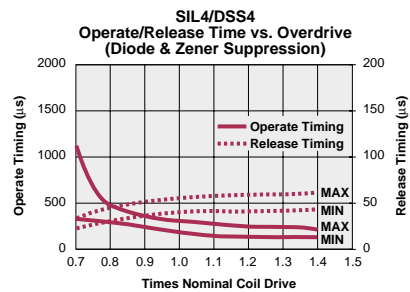
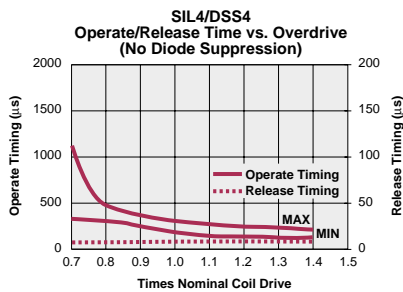
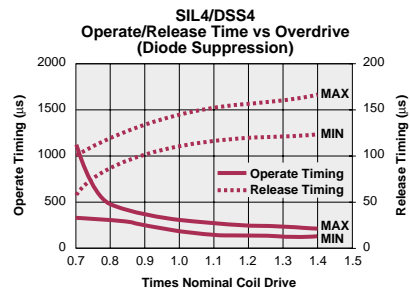
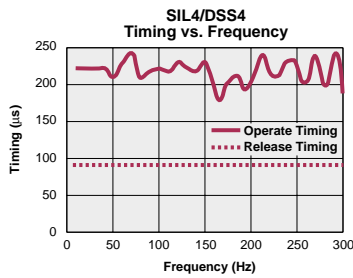

MAGNETIC INTERFERENCE

If relays are inserted in close proximity, the pickup and dropout voltages will be affected by the magnetic flux produced when the coils are energized.

In general, worst-case magnetic interaction conditions for pull-in voltage in a matrix exist when all relay fields have the same polarity and all of the fields are from adjacent relays (See figure).

The direction of the parameter shift is determined by whether the stray flux aids or bucks the flux produced by the coil of the relay under consideration.

To calculate the change in pull-in voltage and dropout voltage, multiply the percent change shown by the relay's nominal voltage. For example, if the percent change in pull-in voltage is 14% for a 5V nominal relay, the pull-in voltage will increase by 0.7 volts.

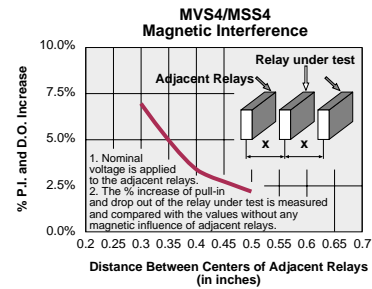
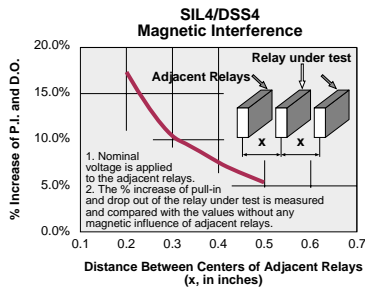

ORDERING INFORMATION

A complete part number is represented by the digits below.

