

Power Relay F4/VF4



Features

- Limiting continuous current 40 A at 85°C
- Pin assignment similar to ISO 7588 part 1
- Plug-in or PCB terminals
- Also available for 42 V applications

Customized Versions on Request

- 24 V versions with contact gap > 0.8 mm
- Integrated components (e.g. resistor, diode)
- Customized marking/color
- Special covers (e.g. notches, release features, brackets)
- Various contact arrangements and materials
- For latching (bistable) version refer to Mini Relay Latching
- For shrouded/weatherproof dust cover versions refer to Shrouded Power Relay F4 A and VF4 A

Typical Applications

Cross carline up to 40 A
for example:

- ABS control
- Blower fans
- Car alarm
- Cooling fan
- Electric Power Steering
- Energy management
- Engine control
- Fuel pump
- Heated front screen
- Ignition
- Immobilizer
- Lamps front, rear, fog light
- Main switch/supply relay
- Seatbelt pretensioner
- Trunk lock
- Valves
- Window lifter
- Wiper control

Please contact Tyco Electronics for relay application support.



134_3Dec_1

Design

- ELV/RoHS/WEEE compliant
- Dustproof: protection class IP54 to IEC 529 (EN 60 529)
- Sealed: protection class IP67 to IEC 529 (EN 60 529)

Weight

Approx. 35 g (1.2 oz.)

Nominal Voltage

12 V or 24 V; other nominal voltages available on request

Terminals

Quick connect terminals similar to ISO 8092-1, coil and load 6.3 x 0.8 mm; surfaces tin plated or PCB terminals

Accessories

Connectors see page 229 ff

Conditions

All parametric, environmental and endurance tests are performed according to EIA Standard RS-407-A at standard test conditions unless otherwise noted:
23°C ambient temperature,
20 - 50% RH, 998.9 ±33.9 hPa.

For general storage and processing recommendations please refer to our Application Notes and especially to *Storage* in the "Glossary" page 23 or at <http://relays.tycoelectronics.com/appnotes/>

Disclaimer

All technical performance data apply to the relay as such, specific conditions of the individual application are not considered. Please always check the suitability of the relay for your intended purpose. We do not assume any responsibility or liability for not complying herewith. We recommend to complete our questionnaire and to request our technical service. Any responsibility for the application of the product remains with the customer only. All specifications are subject to change without notification. All rights of Tyco Electronics are reserved.

Power Relay F4/VF4

Dimensional Drawing

Power Relay F4/VF4 with Quick Connect Terminals

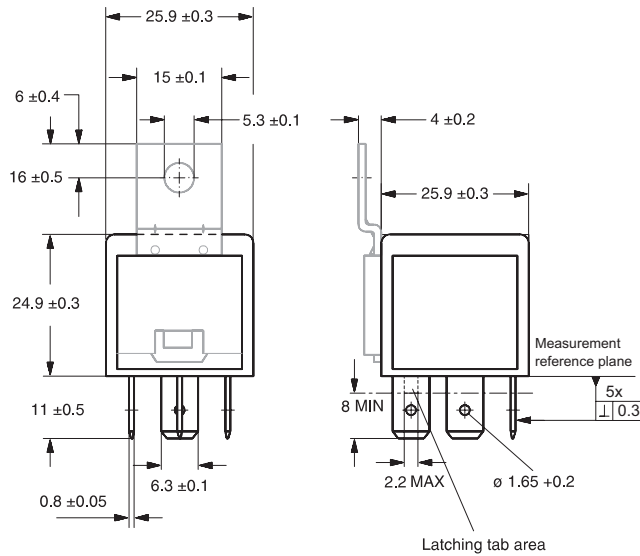

View of the Terminals (bottom view)

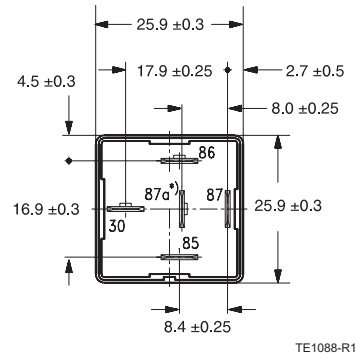

*) For the make contact (2 x 87),
pin 87a = 87
For the double make contact,
pin 87a = 87b

Power Relay F4/VF4 with PCB Terminals

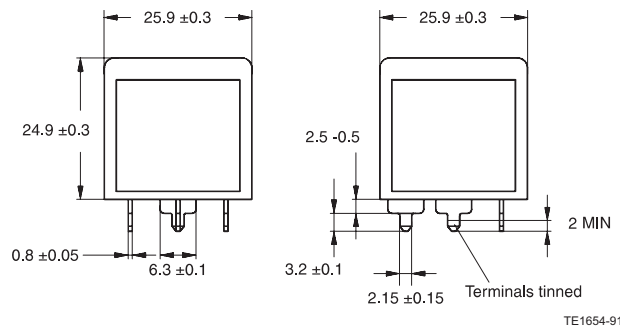

View of the Terminals (bottom view)

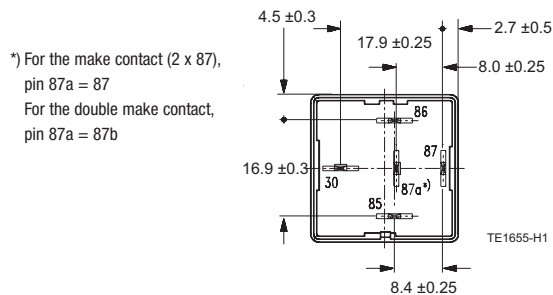

*) For the make contact (2 x 87),
pin 87a = 87
For the double make contact,
pin 87a = 87b

Mounting Holes (bottom view)

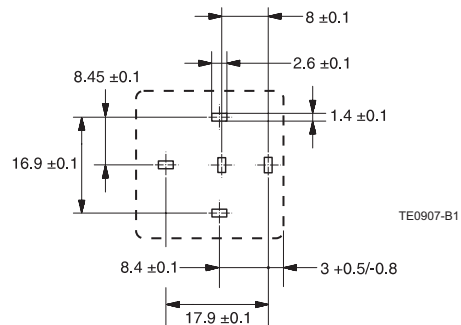

Power Relay F4/VF4

Contact Data									
Contact configuration	1 Make contact/ 1 Form A or 1 Form A (2 x 87)		1 Double make contact/ 1 Form U		1 Changeover contact/ 1 Form C				
Circuit symbol (see also Pin assignment)									
Rated voltage	12 V	24 V	12 V	24 V	12 V	24 V	24 V ³⁾		
Rated current	40 A	20 A	2 x 25 A	2 x 15 A	30/40 A	15/20 A	20/30 A		
Limiting continuous current								NC/NO	
23°C	60 A		2 x 32 A		45/60 A				
85°C	40 A		2 x 35 A		30/40 A				
125°C	17 A		2 x 11 A		12/17 A				
Contact material	Silver based								
Max. switching voltage/power	See load limit curve								
Max. switching current ¹⁾									
On ²⁾	120 A	120 A	2 x 100 A	2 x 100 A	NC/NO 45/120 A	NC/NO 45/120 A	NC/NO 45/120 A		
Off	60 A	20 A	2 x 40 A	2 x 15 A	40/60 A	15/20 A	20/30 A		
Min. recommended load ⁴⁾	1 A at 5 V								
Voltage drop at 10 A (initial)									
NO contact	Typ. 15 mV, 200 mV max.		Typ. 2 x 15 mV, 200 mV max.		Typ. 15 mV, 200 mV max.				
NC contact					Typ. 20 mV, 250 mV max.				
Mechanical endurance (without load)	> 10 ⁷ operations								
Electrical endurance (example of resistive load without component in parallel to the coil)	> 2 x 10 ⁵ operations 40 A, 14 V	> 1 x 10 ⁵ operations 20 A, 28 V	> 2 x 10 ⁵ operations 2 x 25 A, 14 V	> 1 x 10 ⁵ operations 2 x 15 A, 28 V	> 2 x 10 ⁵ operations 40 A, 14 V (NO contact)	> 1 x 10 ⁵ operations 20 A, 28 V (NO contact)	> 1 x 10 ⁵ operations 30 A, 28 V (NO contact) > 5 x 10 ⁵ operations 10 A, 28 V (NC contact)		
Max switching rate at nominal load	6 operations per minute (0.1 Hz)								

- The values apply to a resistive or inductive load with suitable spark suppression and at maximum 14 V for 12 V or 28 V for 24 V load voltages.
- For a load current duration of maximum 3 s for a make/break ratio of 1:10.
- Special high performance 24 V version with contact gap > 0.8 mm, part number V23134-A0056-X432/-X433 (see ordering information).
- See chapter Diagnostics of Relays in our Application Notes page 31 or consult the internet at <http://relays.tycoelectronics.com/appnotes/>

Load Limit Curve

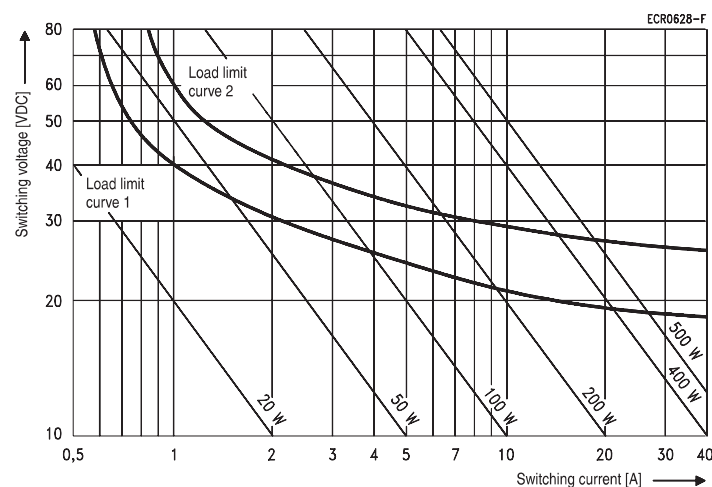

Load limit curve 1 ≙ arc extinguishes during transit time (changeover contact)
Load limit curve 2 ≙ safe shutdown, no stationary arc (make contact)

Power Relay F4/VF4

Circuit Diagram

A0
1 Make contact/1 Form A

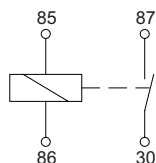

AR
1 Make contact/1 Form A with Resistor

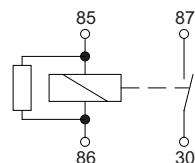

C0
1 Changeover contact/1 Form C

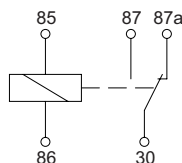

CR
1 Changeover contact/1 Form C with Resistor

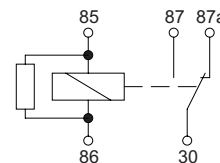

CD
1 Changeover contact/1 Form C with Diode

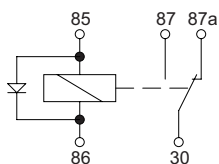

D0
1 Make contact/1 Form A (2 x 87)

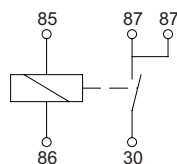

U0
1 Double make contact/1 Form U

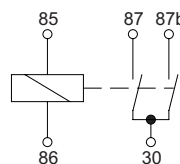

Coil Data

Available for nominal voltages	12 V / 24 V
Nominal power consumption of the unsuppressed coil at nominal voltage	1.6 W
Nominal power consumption at nominal voltage with suppression resistor	1.8 W / 2.1 W (standard/high performance 24 V)
Test voltage winding/contact	500 VAC _{rms}
Ambient temperature range	-40 to +125°C
Operate time at nominal voltage	Typ. 7 ms
Release time at nominal voltage ¹⁾	Typ. 2 ms

¹⁾ For unsuppressed relay coil.

Note:

A low resistive suppression device in parallel to the relay coil increases the release time and reduces the lifetime caused by increased erosion and/or higher risk of contact tack welding.

Operating Voltage Range

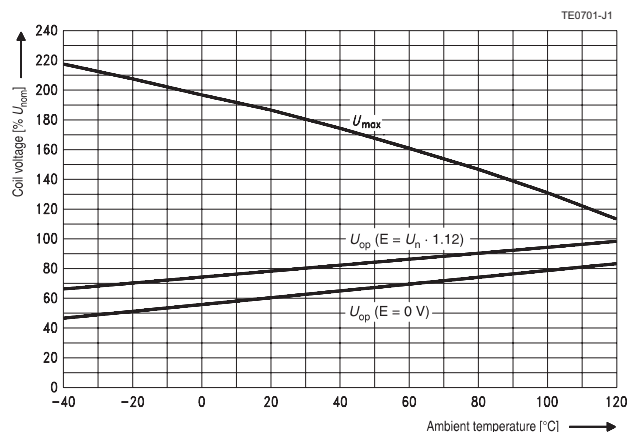

Does not take into account the temperature rise due to the contact current
E = pre-energization

Power Relay F4/VF4

Mechanical Data

Cover retention		
Axial force		150 N
Pull force		150 N
Push force		150 N
Terminals		
Pull force		100 N
Push force		100 N
Resistance to bending, force applied to front		10 N ¹⁾
Resistance to bending, force applied to side		10 N ¹⁾
Torsion		0.3 Nm
Enclosures		
Dust cover	Protects relay from dust. For use in passenger compartment or enclosures	

¹⁾ Values apply 2 mm from the end of the terminal. When the force is removed, the terminal must not have moved by more than 0.3 mm.

Environmental Conditions

Temperature range, storage	Refer to <i>Storage</i> in the "Glossary" catalog page 23 or http://relays.tycoelectronics.com/appnotes/			
Test	Relevant standard	Testing as per	Dimension	Comments
Climatic cycling with condensation	EN ISO 6988		6 cycles	Storage 8/16 h
Temperature cycling	IEC 68-2-14	Nb	10 cycles	-40/+85°C (5°C per min)
Damp heat				
cyclic	IEC 68-2-30	Db, Variant 1	6 cycles	Upper air temperature 55°C
constant	IEC 68-2-3	Ca	56 days	
Corrosive gas	IEC 68-2-42	10 ±2 cm ³ /m ³ SO ₂	10 days	
	IEC 68-2-43	1 ±0.3 cm ³ /m ³ H ₂ S	10 days	
Vibration resistance	IEC 68-2-6 (sine sweep)		10 - 500 Hz min. 5 g	No change in the switching state > 10 μs Valid for NC contacts, NO contact values significantly higher
Shock resistance	IEC 68-2-27 (half sine form single pulses)		min. 20 g 11 ms	
Load dump	ISO 7637-1 (12 V) ISO 7637-2 (24 V)	Test pulse 5 Test pulse 5	Vs = +86.5 V Vs = +200 V	
Jump start	24 V for 5 minutes conducting nominal current at 23°C			
Drop test	Capable of meeting specifications after 1.0 m (3.28 ft) drop onto concrete			
Flammability	UL94-HB or better (meets FMVSS 302) ¹⁾			
Overload current for relays with rated currents as shown in contact data table ²⁾		1.35 x Rated current 1800 s 2.00 x Rated current 5 s 3.50 x Rated current 0.5 s 6.00 x Rated current 0.1 s		

¹⁾ FMVSS: Federal Motor Vehicle Safety Standard.

²⁾ Current and time are compatible with circuit protection by a typical automotive fuse. Relay will make, carry and break the specified current.

Power Relay F4/VF4

Ordering Information

Part Numbers (see table below for coil data)		Part Number	Circuit/Contact Arrangement	Contact Material	Enclosure	Coil Suppression	Bracket
Relay Description	Internal Reference						
6 V Plug-In Relays							
VF4-45D11	V23134-A1051-X826	7-1393305-2	C0/1 Form C	Silver based	Dust cover		Yes
12 V Plug-In Relays							
V23134-A0052-C643		2-1393302-2	C0/1 Form C	Silver based	Dust cover		
V23134-A0052-X205		3-1393302-6	CD/1 Form C	Silver based	Dust cover	Diode (cathode at 86)	
V23134-A0052-X278		4-1393302-1	CR/1 Form C	Silver based	Dust cover	Resistor 560 Ω	
V23134-A1052-C643		5-1393302-8	C0/1 Form C	Silver based	Dust cover		Yes
VF4-45F11-C05	V23134-A1052-X828	7-1393305-5	CR/1 Form C	Silver based	Sealed	Resistor 680 Ω	Yes
V23134-B0052-C642		7-1393302-5	A0/1 Form A	Silver based	Dust cover		
V23134-B0052-X270		1-1414099-0	AR/1 Form A	Silver based	Dust cover	Resistor 680 Ω	
V23134-B1052-C642		3-1393303-4	A0/1 Form A	Silver based	Dust cover		Yes
VF4-41F11-S01	V23134-B1052-X824	6-1393305-9	AR/1 Form A	Silver based	Dust cover	Resistor 680 Ω	Yes
V23134-C0052-C642		3-1393303-9	D0/1 Form A (2 x 87)	Silver based	Dust cover		
V23134-C1052-C642		4-1393303-7	D0/1 Form A (2 x 87)	Silver based	Dust cover		Yes
V23134-M0052-C642		5-1393304-6	U0/1 Form U	Silver based	Dust cover		
V23134-M1052-C642		7-1393304-1	U0/1 Form U	Silver based	Dust cover		Yes
12 V PCB Relays							
V23134-A0052-G243		2-1393302-3	C0/1 Form C	Silver based	Dust cover		
VF4-15F13	V23134-A0052-X811	1393302-6	C0/1 Form C	Silver based	Dust cover		
VF4-15F13-C01	V23134-A0052-X812	4-1393305-5	C0/1 Form C	Silver based	Sealed		
VF4-15F13-C05	V23134-A0052-X813	4-1393305-7	CR/1 Form C	Silver based	Sealed	Resistor 680 Ω	
V23134-B0052-G242		7-1393302-7	A0/1 Form A	Silver based	Dust cover		
VF4-11F13	V23134-B0052-X801	2-1393305-1	A0/1 Form A	Silver based	Dust cover		
VF4-11F13-C01	V23134-B0052-X802	2-1393305-2	A0/1 Form A	Silver based	Sealed		
V23134-C0052-G242		4-1393303-0	D0/1 Form A (2 x 87)	Silver based	Dust cover		
V23134-M0052-G242		5-1393304-7	U0/1 Form U	Silver based	Dust cover		
24 V Plug-In Relays							
V23134-A0053-C643		5-1393302-1	C0/1 Form C	Silver based	Dust cover		
V23134-A0056-X432 ¹⁾		1-1414167-0	CD/1 Form C	Silver based	Dust cover	Diode (cathode at 86)	
V23134-A0056-X433 ¹⁾		1-1414168-0	CR/1 Form C	Silver based	Dust cover	Resistor 1200 kΩ	
VF4-15H11-C05	V23134-A0064-X816	5-1393305-3	CR/1 Form C	Silver based	Sealed	Resistor 2700 kΩ	
V23134-A1053-C643		6-1393302-3	C0/1 Form C	Silver based	Dust cover		Yes
VF4-45H11-C05	V23134-A1064-X829	1432219-1	CR/1 Form C	Silver based	Sealed	Resistor 2700 kΩ	Yes
VF4-15H11-S05	V23134-A1064-X830	8-1393305-4	CD/1 Form C	Silver based	Dust cover	Diode (cathode at 86)	Yes
V23134-B0053-C642		1393303-9	A0/1 Form A	Silver based	Dust cover		
VF4-41H11	V23134-B1064-X825	7-1393305-0	A0/1 Form A	Silver based	Dust cover		Yes
VF4-41H11-S08	V23134-A1064-X831	7-1393305-1	AR/1 Form A	Silver based	Dust cover	Resistor 2700 kΩ	Yes
V23134-B1053-C642		3-1393303-7	A0/1 Form A	Silver based	Dust cover		Yes
V23134-C0053-C642		4-1393303-4	D0/1 Form A (2 x 87)	Silver based	Dust cover		
V23134-C1053-C642		5-1393303-0	D0/1 Form A (2 x 87)	Silver based	Dust cover		Yes
V23134-M0053-C642		6-1393304-7	U0/1 Form U	Silver based	Dust cover		
V23134-M1053-C642		7-1393304-4	U0/1 Form U	Silver based	Dust cover		Yes
24 V PCB Relays							
V23134-A0053-G243		5-1393302-2	C0/1 Form C	Silver based	Dust cover		
VF4-11H13	V23134-B0064-X804	2-1393305-6	A0/1 Form A	Silver based	Dust cover		
VF4-15H13	V23134-A0064-X819	1393302-8	C0/1 Form C	Silver based	Dust cover		
VF4-15H13-C01	V23134-A0064-X820	5-1393305-9	C0/1 Form C	Silver based	Sealed		
V23134-B0053-G242		1-1393303-0	A0/1 Form A	Silver based	Dust cover		
V23134-C0053-G242		4-1393303-5	D0/1 Form A (2 x 87)	Silver based	Dust cover		
V23134-M0053-G242		6-1393304-8	U0/1 Form U	Silver based	Dust cover		

¹⁾ Special feature: contact gap > 0.8 mm.

Power Relay F4/VF4

Coil Versions

Coil Data for Power F4/VF4	Rated Coil Voltage (V)	Coil Resistance $\pm 10\%$ (Ω)	Must Operate Voltage (V)	Must Release Voltage (V)	Allowable Overdrive ¹⁾ Voltage (V)	
					at 23°C	at 85°C
VF4-**D**-**	6	22	3.6	0.6	11	8
VF4-**F**-**	12	90	7.2	1.2	22	17
V23134-**052-****	12	90	7.2	1.6	22	17
VF4-**H**-**	24	360	14.4	2.4	40	30
V23134-**053-****	24	324	14.4	3.2	41	32
V23134-**056-****	24	268	16.0	4.0	38	29
V23134-**064-****	24	360	14.4	2.4	40	30

¹⁾ Allowable overdrive is stated with no load applied and minimum coil resistance.

Standard Delivery Packs (orders in multiples of delivery pack)

Power F4	Quick connect version:	315 pieces
	Quick connect with bracket:	200 pieces
	PCB version:	200 pieces
VF4-1, VF4-4		300 pieces