

# General Purpose Power Relays MKS-X

## MK-S-series Relays with AC and DC Load switching Models

- Models for DC Loads can switch 220 VDC, 10 A (resistive).
- Models for AC Loads can switch 250 VAC, 15 A (resistive).
- Lineup includes models with 1FormA and 1FormA+1FormB contact arrangements.
- Models available with operation indicators and built-in test buttons.
- Standards: UL/CSA, IEC (TÜV certification)
- RoHS compliant.

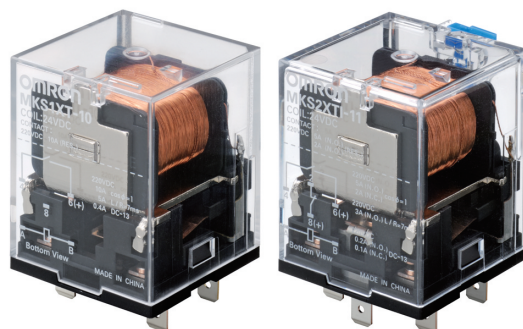

## Ordering Information

### List of Models

Type	Contact form	Models for DC Loads		Models for AC Loads	
		SPST-NO	SPST-NO/SPST-NC	SPST-NO	SPST-NO/SPST-NC
		Model	Model	Model	Model
Standard		MKS1XT-10	MKS2XT-11	MKS1T-10	MKS2T-11
Built-in Operation Indicators		MKS1XTN-10	MKS2XTN-11	MKS1TN-10	MKS2TN-11
Test Button		MKS1XTI-10	MKS2XTI-11	MKS1TI-10	MKS2TI-11
Test Button and Built-in Operation Indicators		MKS1XTIN-10	MKS2XTIN-11	MKS1TIN-10	MKS2TIN-11

**Note:** 1. When ordering, add the rated voltage to the model number. Rated voltages are given in the coil ratings table in the specifications.

Example: MKS2XTIN-11 AC240

Rated voltage

2. Refer to *Terminal Arrangement and Internal Connections* for all wiring diagrams.

### Accessory (Order Separately)

#### Connecting Socket and Hold-down Clips

Classifications		Built-in diode	Socket	Hold-down Clip
Back-connecting Socket	PCB Mount	No	P7M-06P	PYC-A2
Front-connecting Socket	DIN Track or Panel Mount	No	P7MF-06	
		Yes	P7MF-06-D	

**Note:** 1. The P7M-06P, P7MF-06, and P7MF-06-D can be used with models for DC loads with an SPST-NO or SPST-NO/SPST-NC contact form or with models for AC loads with an SPST-NO or SPST-NO/SPST-NC contact form.

2. The P7MF-06-D has a built-in diode and can thus be used only with Relays with DC operating coils. Do not use it with a Relay with an AC operating coil.

3. Refer to *Gang Mounting* in the *Safety Precautions* section for the conditions required to gang mount multiple relays side-by-side.

4. Use the Clips to securely mount the Relay and prevent it from falling due to vibration or shock.

# Specifications

## ■ Contact Ratings

### Models for DC Loads

Contact form Model Load		SPST-NO			SPST-NO/SPST-NC		
		MKS1XT(I)(N)-10			MKS2XT(I)(N)-11		
		Resistive load	Inductive load		Resistive load	Inductive load	
L/R = 7 ms	DC13 class		L/R = 7 ms	DC13 class			
Contact configuration	NO	Double-break			Double-break		
	NC	---			Single-break		
Contact material		AgSnIn			AgSnIn		
Rated load	NO	10 A, 220 VDC	5 A, 220 VDC	0.4 A, 220 VDC	5 A, 220 VDC	3 A, 220 VDC	0.2 A, 220 VDC
	NC	---			2 A, 220 VDC	0.3 A, 220 VDC	0.1 A, 220 VDC
Rated carry current	NO	10 A			5 A		
	NC	---			2 A		
Max. switching voltage	NO	220 VDC			220 VDC		
	NC	---			---		
Max. switching current	NO	10 A			5 A		
	NC	---			2 A		
Max. switching capacity (reference value)	NO	2,200 W	---	---	1,100 W	---	---
	NC	---			440 W	---	---

- Note:** 1. If the L/R of an inductive load exceeds 7 ms with a Model for a DC Load, the arc interruption time must be less than approximately 50 ms to use the Relay. Design the circuit so that the arc interruption time is 50 ms or less.  
 2. These values apply to a switching frequency of 30 times per minute.

### Models for AC Loads

Contact form Model Load		SPST-NO	SPST-NO/SPST-NC
		MKS1T(I)(N)-10	MKS2T(I)(N)-11
		Resistive load	Resistive load
Contact configuration	NO	Double-break	Double-break
	NC	---	Single-break
Contact material		AgSnIn	AgSnIn
Rated load	NO	15 A, 250 VAC	15 A, 250 VAC
	NC	---	5 A, 250 VAC
Rated carry current	NO	15 A	15 A
	NC	---	5 A
Max. switching voltage	NO	250 VAC	250 VAC
	NC	---	
Max. switching current	NO	15 A	15 A
	NC	---	5 A
Max. switching capacity (reference value)	NO	3,750 VA	3,750 VA
	NC	---	1,250 VA

**Note:** These values apply to a switching frequency of 20 times per minute.

## ■ Coil Ratings

Item	Rated voltage (V)	Rated current (mA)		Coil resistance (Ω)	Must operate voltage (V)	Must release voltage (V)	Max. voltage (V)	Power consumption (VA, W)
		50 Hz	60 Hz					
AC	24	110	96.3	48.4	80% max. of rated voltage	30% min. of rated voltage at 60 Hz	110% of rated voltage	Approx. 2.3 VA at 60 Hz
	100	26.6	23.1	760				
	110	24.2	21.0	932				
	120	22.2	19.3	1,130				
	200	13.3	11.6	3,160		25% min. of rated voltage at 50 Hz		
	220	12.1	10.5	3,550				
	230	11.5	10.0	4,250				
	240	11.0	9.6	4,480				
DC	12	126		95	15% min. of rated voltage		Approx. 1.5 W	
	24	63.2		380				
	48	32.0		1,500				
	110	13.6		8,060				
	220	6.8		32,200				

- Note:**
1. The rated current and coil resistance are measured at a coil temperature of 23°C with tolerances of +15%/-20% for AC rated current and ±15% for DC coil resistance.
  2. Performance characteristic data are measured at a coil temperature of 23°C.
  3. The Maximum Voltage is the highest voltage that can be applied to the coil temporarily, not continuously.
  4. The rated current is approximately 5 mA higher for Models with Built-in Operation Indicators (DC operating coils).

## ■ Characteristics

<b>Contact resistance (See note 2)</b>		100 mΩ max.
<b>Operate time (See note 3)</b>		AC: 20 ms max. DC: 30 ms max.
<b>Release time (See note 3)</b>		20 ms max.
<b>Max. operating frequency</b>	<b>Mechanical</b>	18,000 operations/h
	<b>Electrical</b>	Models for DC loads: 1,800 times/hour Models for AC loads: 1,200 times/hour
<b>Insulation resistance (See note 4)</b>		100 MΩ min.
<b>Dielectric strength</b>		2,500 VAC 50/60 Hz for 1 min. between coil and contacts
		2,500 VAC 50/60 Hz for 1 min. between contacts of different polarity
		1,000 VAC 50/60 Hz for 1 min. between contacts of same polarity
<b>Vibration resistance</b>		Destruction: 10 to 55 Hz, 1.0-mm double amplitude Malfunction: 10 to 55 Hz, 1.5-mm double amplitude
<b>Shock resistance</b>		Destruction: 1,000 m/s <sup>2</sup> when relay is properly mounted into P7M-06P PCB socket 500m/s <sup>2</sup> when relay is properly mounted into P7MF-06(-D) socket Malfunction 100 m/s <sup>2</sup>
<b>Life expectancy</b>	<b>Mechanical</b>	1,000,000 operations min. (at 18,000 operations/hr)
	<b>Electrical (See note 5)</b>	100,000 operations min. (at rated load and maximum switching frequency)
<b>Minimum permissible load (Reference value. See note 6)</b>		10 mA at 24 VDC
<b>Ambient operating temperature</b>		-40°C to 60°C (with no icing or condensation) <b>Note:</b> The range is -25°C to 60°C for models with built-in operation indicators.
<b>Ambient operating humidity</b>		5% to 85%
<b>Weight</b>		SPST-NO: Approx. 73 g, SPST-NO/SPST-NC: Approx. 82 g

- Note:**
1. The values given above are initial values.
  2. The contact resistance was measured for 1 A at 5 VDC using the voltage drop method.
  3. The operate time was measured with the rated voltage imposed and any contact bounce ignored at an ambient temperature of 23°C.
  4. The insulation resistance was measured with a 500-VDC insulation resistance tester at the same places as those used for checking the dielectric strength.
  5. The electrical endurance was measured at an ambient temperature of 23°C.
  6. P level:  $\lambda_{60}=0.1 \times 10^{-6}/\text{operations}$

## ■ Approved Standards

UL Recognized  US  
 CSA Certified  US

Model	Coil ratings	Contact ratings		Operations
MKS1XT□-□	12 to 220 VDC 24 to 240 VAC	NO contacts	10 A, 220 VDC (Resistive)	6,000
MKS2XT□-□			5 A, 220 VDC L/R ( $T_{0.632}$ ) = 7 ms	
		0.4 A, 220 VDC L/R ( $T_{0.95}$ ) = 300 ms		
		NO contacts	5 A, 220 VDC (Resistive)	
MKS1T□-□		NO contacts	3 A, 220 VDC L/R ( $T_{0.632}$ ) = 7 ms	
	0.2 A, 220 VDC L/R ( $T_{0.95}$ ) = 300 ms			
MKS2T□-□	NO contacts	2 A, 220 VDC (Resistive)		
		NC contacts	0.3 A, 220 VDC L/R ( $T_{0.632}$ ) = 7 ms	
MKS1T□-□	NO contacts	0.1 A, 220 VDC L/R ( $T_{0.95}$ ) = 300 ms		
		NC contacts	15 A, 250 VAC (Resistive)	
MKS2T□-□	NO contacts	15 A, 250 VAC (Resistive)		
		NC contacts	5 A, 250 VAC (Resistive)	

## IEC Standard/TÜV Certification: IEC61810-1 (Certification No. R50104853)

Model	Coil ratings	Contact ratings		Operations
MKS1XT□-□	12, 24, 48, 110, 220 VDC 24, 100, 110, 120, 200, 220, 230, 240 VAC	NO contacts	DC-1: 10 A, 220 VDC	100,000
MKS2XT□-□			5 A, 220 VDC L/R ( $T_{0.632}$ ) = 7 ms	
		DC-13: 0.4 A, 220 VDC		
		NO contacts	DC-1: 5 A, 220 VDC	
MKS1T□-□		NO contacts	3 A, 220 VDC L/R ( $T_{0.632}$ ) = 7 ms	
	DC-13: 0.2 A, 220 VDC			
MKS2T□-□	NO contacts	DC-1: 2 A, 220 VDC		
		NC contacts	0.3 A, 220 VDC L/R ( $T_{0.632}$ ) = 7 ms	
MKS1T□-□	NO contacts	DC-13: 0.1 A, 220 VDC		
		NC contacts	AC-1: 15 A, 250 VAC 50/60 Hz	
MKS2T□-□	NO contacts	AC-1: 15 A, 250 VAC 50/60 Hz		
		NC contacts	AC-1: 5 A, 250 VAC 50/60 Hz	

# Engineering Data

## Maximum Switching Power

**MKS1XT□-10**

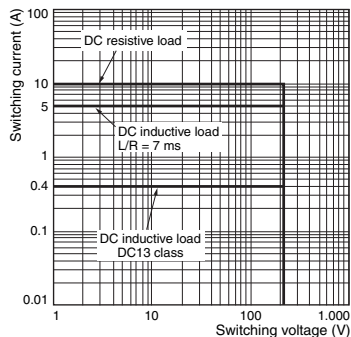

**MKS2XT□-11**

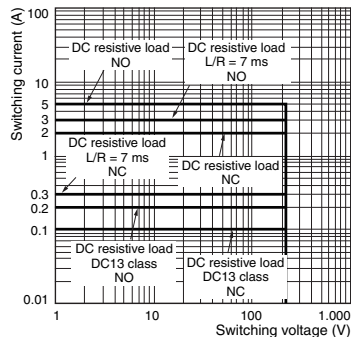

**MKS1T□-10**

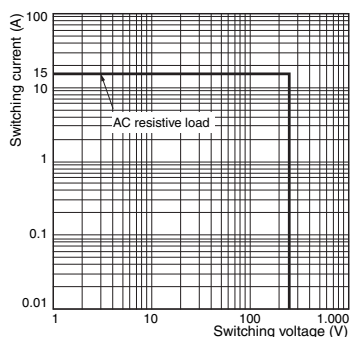

**MKS2T□-11**

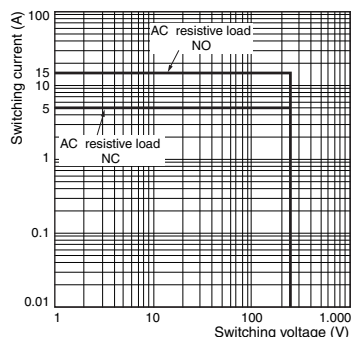

## Ambient Temperature vs. Pick-up and Drop out Voltage

**MKS2XT-11  
AC Specification (60 Hz)**

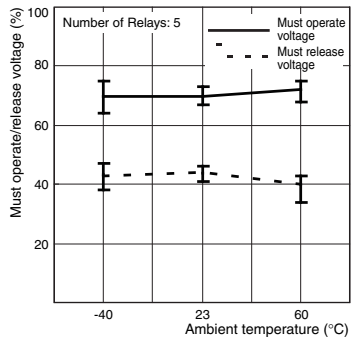

**MKS2XT-11  
DC Specification**

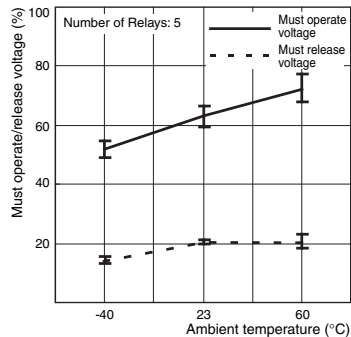

## Inductive Load Switching Power (Models for DC Loads)

**MKS1XT□-10**

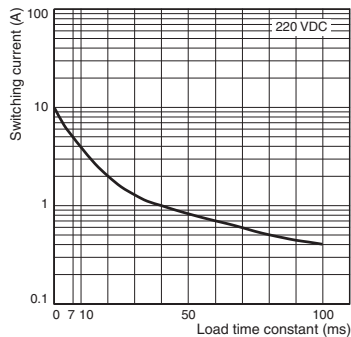

**MKS2XT□-11**

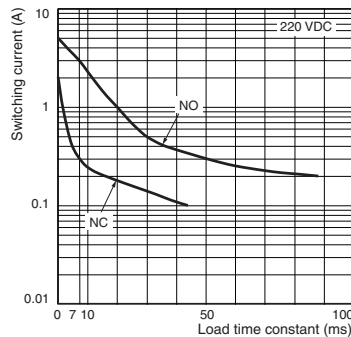

# Dimensions

(Unit: mm)

## Models for DC Loads

### Standard Models

MKS1XT-10      MKS2XT-11

### Models with Built-in Operation Indicators

MKS1XTN-10      MKS2XTN-11

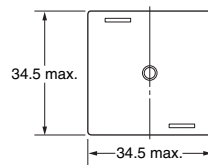

## Models for AC Loads

### Standard Models

MKS1T-10      MKS2T-11

### Models with Built-in Operation Indicators

MKS1TN-10      MKS2TN-11

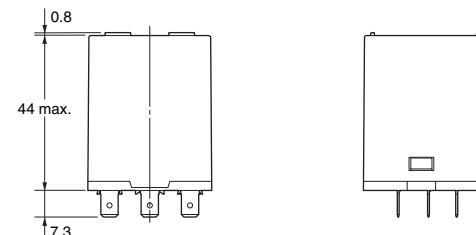

## Models for DC Loads

### Models with Test Button

MKS1XTI-10      MKS2XTI-11

### Models with Test Button and Built-in Operation Indicators

MKS1XTIN-10      MKS2XTIN-11

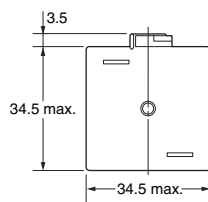
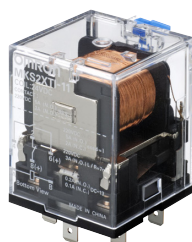

## Models for AC Loads

### Models with Test Button

MKS1TI-10      MKS2TI-11

### Models with Test Button and Built-in Operation Indicators

MKS1TIN-10      MKS2TIN-11

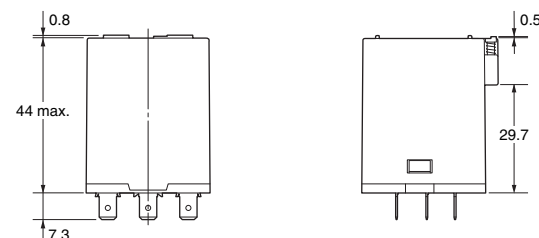

## Terminal Arrangement and Internal Connection (Bottom View)

MKS1XT-10 MKS1XTI-10	MKS1XTN-10 MKS1XTIN-10		MKS2XT-11 MKS2XTI-11	MKS2XTN-11 MKS2XTIN-11	
	DC specification	AC specification		DC specification	AC specification
MKS1T-10 MKS1TI-10	MKS1TN-10 MKS1TIN-10		MKS2T-11 MKS2TI-11	MKS2TN-11 MKS2TIN-11	
	DC specification	AC specification		DC specification	AC specification

- Note:** 1. Wire properly using the correct coil polarity.  
 2. The contact terminals on Models for DC Loads have polarity. Wire properly using the correct polarity.

**Connecting Socket**  
**Back-connecting Socket**  
**P7M-06P**

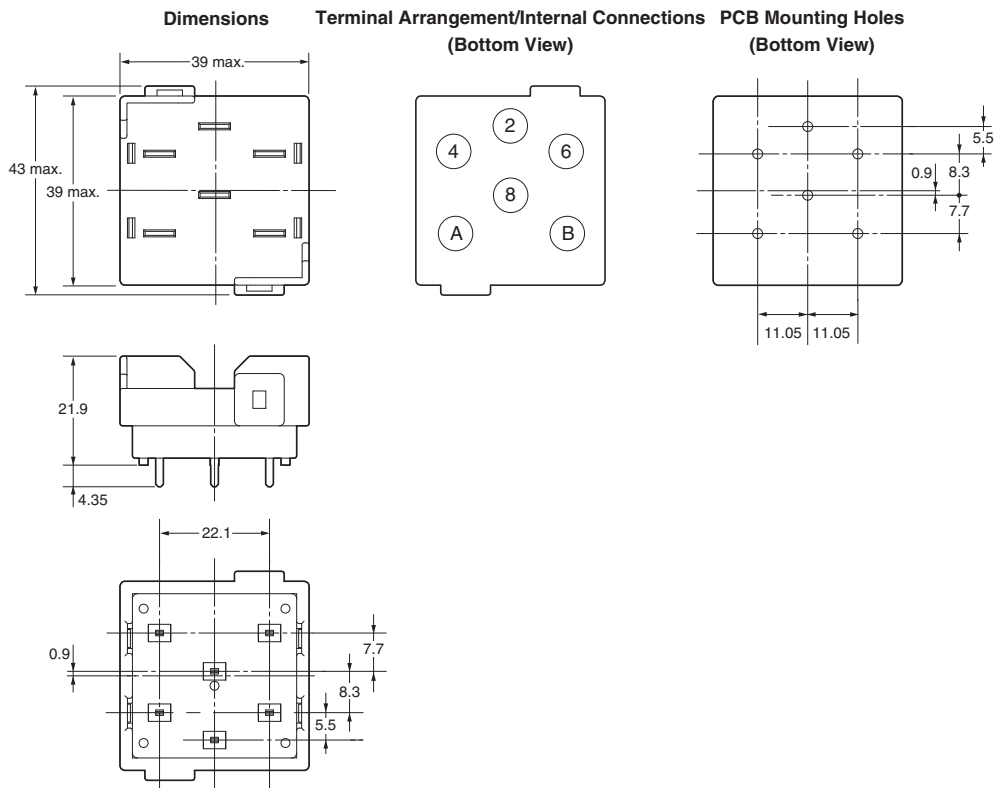
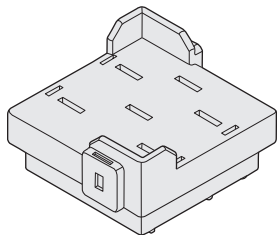

**Front-connecting Socket**  
**P7MF-06**  
**P7MF-06-D**

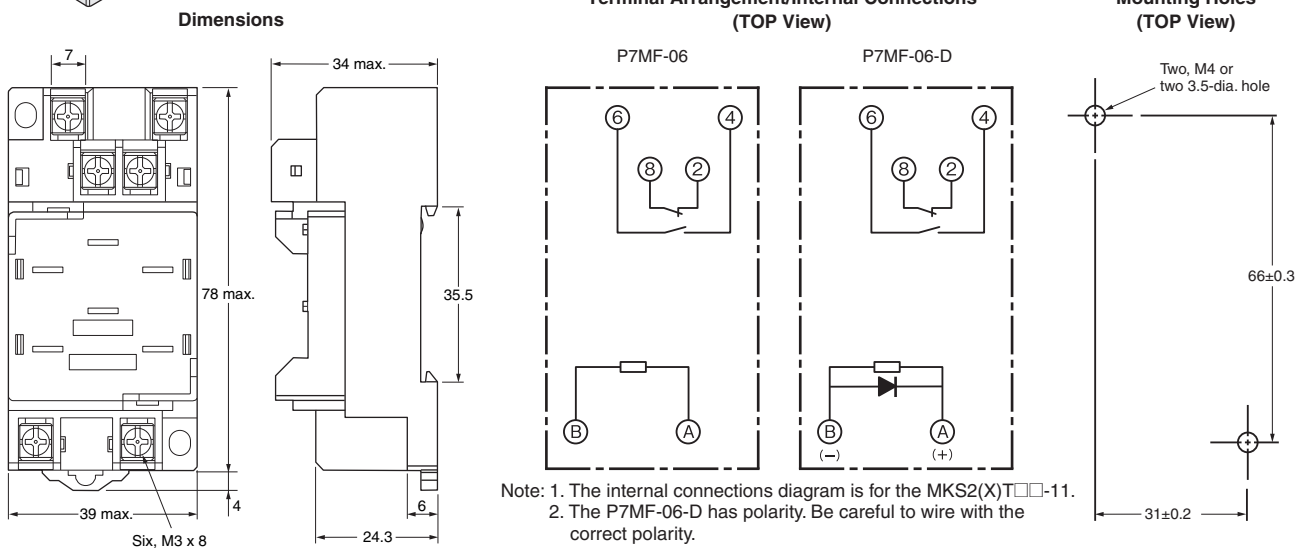
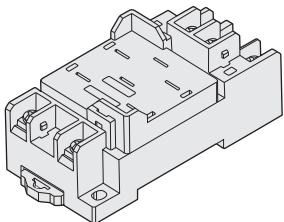

## Hold-down Clip

PYC-A2  
One Set (Two Clips)

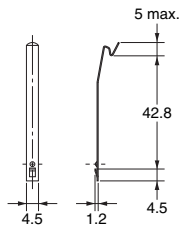

**Note:** The minimum order for the PYC-A2 is ten clips.

## Socket Mounting Height

P7M-06P

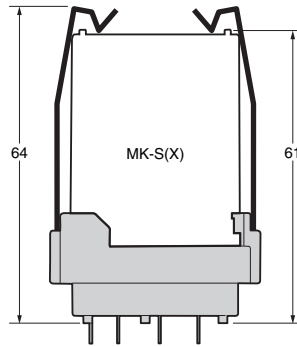
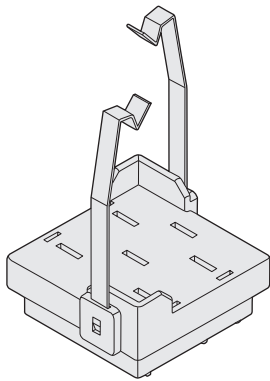

P7MF-06  
P7MF-06-D

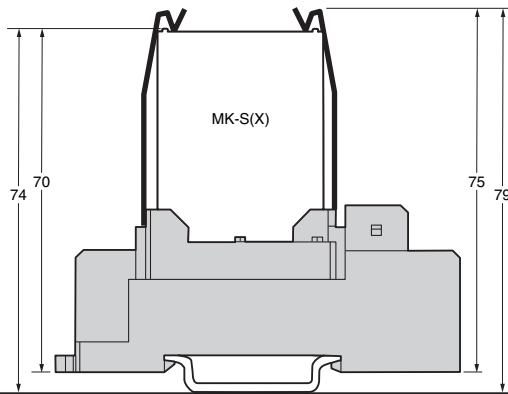
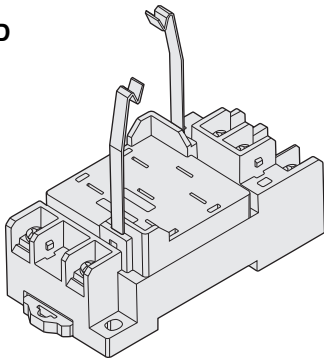



# Safety Precautions

Be sure to read the precautions and information common to all electromechanical relays, contained in the Technical User's Guide, "Electromechanical Relays, Technical Information" for correct use.

## Precautions for Correct Use

### Installation

- Models for DC loads (i.e., models with "X" in the model number) have permanent magnets built into the insulating block. If a permanent magnet or other magnetic body comes near the Relay, magnetic interference will occur with the built-in permanent magnet and the contact switching capacity will be decreased.
- Models for AC loads do not contain a permanent magnet.
- When mounting a P7MF-06(-D) Front-mounting Socket to a DIN Track, attach PFP-M End Plates on both sides of the Socket to prevent it from moving.

### Gang Mounting

Conditions for mounting multiple MKS-X relays on the same DIN rail.

Relay	Rated current of Relay	Socket	
		Back-Connecting Socket	Front-Connecting Socket
Models for DC Loads	10A	○	○
Models for AC Loads	15A	○	*

\* Gang mounting of the Front-Mounting Sockets is not possible if the contact carry current exceeds 10A. Provide space on both the right and left sides of the Sockets. The mounting pitch is given in the following diagram.

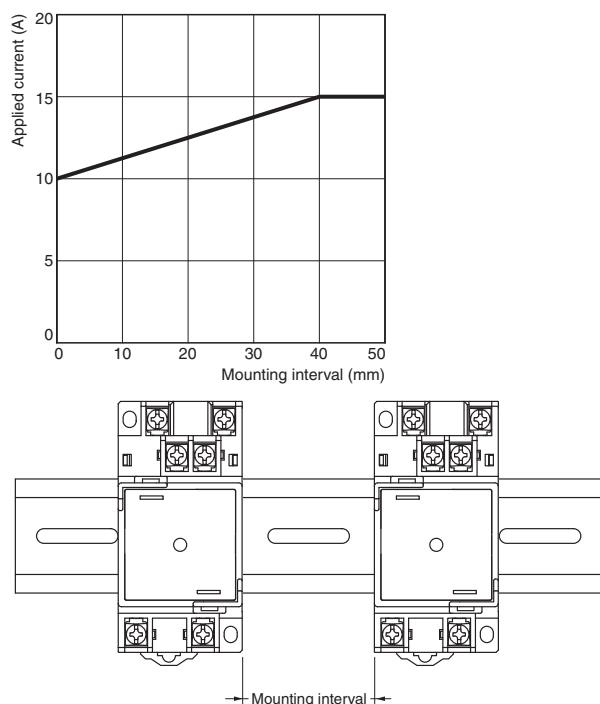

### Wiring

- The contact terminals on Models for DC Loads (i.e., models with "X" in the model number) have polarity. Wiring with incorrect polarity may result in inability to turn OFF the Relay or loss of functionality.
- Be sure to check polarity when wiring DC coil MKS-X relays with built-in operation indicators.

### Operating Environment

Do not use the Relay in environments with combustible gas. Doing so may result in explosion due to arcing.

### Storage

Models for DC Loads (i.e., models with "X" in the model number) are magnetized because they have a built-in magnet to deflect and extinguish the arc. Do not install the Relay near IC cards or other items that may be adversely affected by magnetism.

### Usage

Use the Relay mounted in the P7M-06P or P7MF-06(-D) Socket.

### Test Button

- Turn OFF the power supply before operating the test button. Always return the test button to the original position after you use it.
- Do not use the test button as a switch.
- The durability of the test button is 100 operations minimum.

The circuit can be checked using either of two modes.

#### Test Button

DC specification: Blue  
AC specification: Red

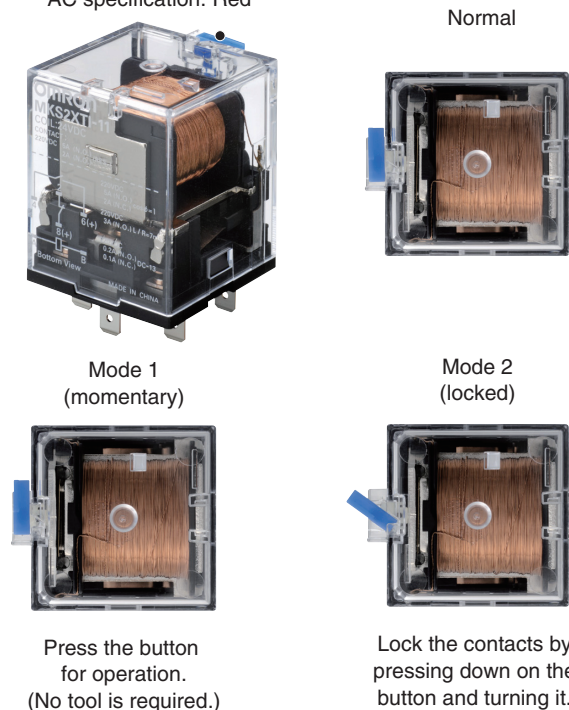

### Test Button Applications

Example: Checking operation of Relays and sequence circuits.

MEMO

A large grid of dashed lines for taking notes, consisting of 20 columns and 30 rows of small squares.

# Omron Electronic Components, LLC

## Terms and Conditions of Sales

### I. GENERAL

- Definitions:** The words used herein are defined as follows.
  - Terms:** These terms and conditions
  - Seller:** Omron Electronic Components LLC and its subsidiaries
  - Buyer:** The buyer of Products, including any end user in section III through VI
  - Products:** Products and/or services of Seller
  - Including:** Including without limitation
- Offer/Acceptance:** These Terms are deemed part of all quotations, acknowledgments, invoices, purchase orders and other documents, whether electronic or in writing, relating to the sale of Products by Seller. Seller hereby objects to any Terms proposed in Buyer's purchase order or other documents which are inconsistent with, or in addition to, these Terms.
- Distributor:** Any distributor shall inform its customer of the contents after and including section III of these Terms.

### II. SALES

- Prices/Payment:** All prices stated are current, subject to change without notice by Seller. Buyer agrees to pay the price in effect at the time the purchase order is accepted by Seller. Payments for Products received are due net 30 days unless otherwise stated in the invoice. Buyer shall have no right to set off any amounts against the amount owing in respect of this invoice.
- Discounts:** Cash discounts, if any, will apply only on the net amount of invoices sent to Buyer after deducting transportation charges, taxes and duties, and will be allowed only if (a) the invoice is paid according to Seller's payment terms and (b) Buyer has no past due amounts owing to Seller.
- Interest:** Seller, at its option, may charge Buyer 1.5% interest per month or the maximum legal rate, whichever is less, on any balance not paid within the stated terms.
- Orders:** Seller will accept no order less than 200 U.S. dollars net billing.
- Currencies:** If the prices quoted herein are in a currency other than U.S. dollars, Buyer shall make remittance to Seller at the then current exchange rate most favorable to Seller; provided that if remittance is not made when due, Buyer will convert the amount to U.S. dollars at the then current exchange rate most favorable to Seller available during the period between the due date and the date remittance is actually made.
- Governmental Approvals:** Buyer shall be responsible for all costs involved in obtaining any government approvals regarding the importation or sale of the Products.
- Taxes:** All taxes, duties and other governmental charges (other than general real property and income taxes), including any interest or penalties thereon, imposed directly or indirectly on Seller or required to be collected directly or indirectly by Seller for the manufacture, production, sale, delivery, importation, consumption or use of the Products sold hereunder (including customs duties and sales, excise, use, turnover and license taxes) shall be charged to and remitted by Buyer to Seller.
- Financial:** If the financial position of Buyer at any time becomes unsatisfactory to Seller, Seller reserves the right to stop shipments or require satisfactory security or payment in advance. If Buyer fails to make payment or otherwise comply with these Terms or any related agreement, Seller may (without liability and in addition to other remedies) cancel any unshipped portion of Products sold hereunder and stop any Products in transit until Buyer pays all amounts, including amounts payable hereunder, whether or not then due, which are owing to it by Buyer. Buyer shall in any event remain liable for all unpaid accounts.
- Cancellation, Etc:** Orders are not subject to rescheduling or cancellation unless Buyer indemnifies Seller fully against all costs or expenses arising in connection therewith.
- Force Majeure:** Seller shall not be liable for any delay or failure in delivery resulting from causes beyond its control, including earthquakes, fires, floods, strikes or other labor disputes, shortage of labor or materials, accidents to machinery, acts of sabotage, riots, delay in or lack of transportation or the requirements of any government authority.
- Shipping/Delivery:** Unless otherwise expressly agreed in writing by Seller:
  - All sales and shipments of Products shall be FOB shipping point (unless otherwise stated in writing by Seller), at which point title to and all risk of loss of the Products shall pass from Seller to Buyer, provided that Seller shall retain a security interest in the Products until the full purchase price is paid by Buyer;
  - Delivery and shipping dates are estimates only; and
  - Seller will package Products as it deems proper for protection against normal handling and extra charges apply to special conditions.
- Claims:** Any claim by Buyer against Seller for shortage or damage to the Products occurring before delivery to the carrier or any claim related to pricing or other charges must be presented in detail in writing to Seller within 30 days of receipt of shipment.

### III. PRECAUTIONS

- Suitability:** IT IS THE BUYER'S SOLE RESPONSIBILITY TO ENSURE THAT ANY OMRON PRODUCT IS FIT AND SUFFICIENT FOR USE IN A MOTORIZED VEHICLE APPLICATION. BUYER SHALL BE SOLELY RESPONSIBLE FOR DETERMINING APPROPRIATENESS OF THE PARTICULAR PRODUCT WITH RESPECT TO THE BUYER'S APPLICATION INCLUDING (A) ELECTRICAL OR ELECTRONIC COMPONENTS, (B) CIRCUITS, (C) SYSTEM ASSEMBLIES, (D) END PRODUCT, (E) SYSTEM, (F) MATERIALS OR SUBSTANCES OR (G) OPERATING ENVIRONMENT. Buyer acknowledges that it alone has determined that the Products will meet their requirements of the intended use in all cases. Buyer must know and observe all prohibitions of use applicable to the Product/s.
- Use with Attention:** The followings are some examples of applications for which particular attention must be given. This is not intended to be an exhaustive list of all possible use of any Product, nor to imply that any use listed may be suitable for any Product:
  - Outdoor use, use involving potential chemical contamination or electrical interference.

- Use in consumer Products or any use in significant quantities.
  - Energy control systems, combustion systems, railroad systems, aviation systems, medical equipment, amusement machines, vehicles, safety equipment, and installations subject to separate industry or government regulations.
  - Systems, machines, and equipment that could present a risk to life or property.
- Prohibited Use:** NEVER USE THE PRODUCT FOR AN APPLICATION INVOLVING SERIOUS RISK TO LIFE OR PROPERTY WITHOUT ENSURING THAT THE SYSTEM AS A WHOLE HAS BEEN DESIGNED TO ADDRESS THE RISKS, AND THAT THE PRODUCT IS PROPERLY RATED AND INSTALLED FOR THE INTENDED USE WITHIN THE OVERALL EQUIPMENT OR SYSTEM.
  - Motorized Vehicle Application:** USE OF ANY PRODUCT/S FOR A MOTORIZED VEHICLE APPLICATION MUST BE EXPRESSLY STATED IN THE SPECIFICATION BY SELLER.
  - Programmable Products:** Seller shall not be responsible for the Buyer's programming of a programmable Product.

### IV. WARRANTY AND LIMITATION

- Warranty:** Seller's exclusive warranty is that the Products will be free from defects in materials and workmanship for a period of twelve months from the date of sale by Seller (or such other period expressed in writing by Seller). SELLER MAKES NO WARRANTY OR REPRESENTATION, EXPRESS OR IMPLIED, ABOUT ALL OTHER WARRANTIES, NON-INFRINGEMENT, MERCHANTABILITY OR FITNESS FOR A PARTICULAR PURPOSE OF THE PRODUCTS.
- Buyer Remedy:** Seller's sole obligation hereunder shall be to replace (in the form originally shipped with Buyer responsible for labor charges for removal or replacement thereof) the non-complying Product or, at Seller's election, to repay or credit Buyer an amount equal to the purchase price of the Product; provided that there shall be no liability for Seller or its affiliates unless Seller's analysis confirms that the Products were correctly handled, stored, installed and maintained and not subject to contamination, abuse, misuse or inappropriate modification. Return of any Products by Buyer must be approved in writing by Seller before shipment.
- Limitation on Liability:** SELLER AND ITS AFFILIATES SHALL NOT BE LIABLE FOR SPECIAL, INDIRECT, INCIDENTAL OR CONSEQUENTIAL DAMAGES, LOSS OF PROFITS OR PRODUCTION OR COMMERCIAL LOSS IN ANY WAY CONNECTED WITH THE PRODUCTS, WHETHER SUCH CLAIM IS BASED IN CONTRACT, WARRANTY, NEGLIGENCE OR STRICT LIABILITY. FURTHER, IN NO EVENT SHALL LIABILITY OF SELLER OR ITS AFFILIATES EXCEED THE INDIVIDUAL PRICE OF THE PRODUCT ON WHICH LIABILITY IS ASSERTED.
- Indemnities:** Buyer shall indemnify and hold harmless Seller, its affiliates and its employees from and against all liabilities, losses, claims, costs and expenses (including attorney's fees and expenses) related to any claim, investigation, litigation or proceeding (whether or not Seller is a party) which arises or is alleged to arise from Buyer's acts or omissions under these Terms or in any way with respect to the Products.

### V. INFORMATION; ETC.

- Intellectual Property:** The intellectual property embodied in the Products is the exclusive property of Seller and its affiliates and Buyer shall not attempt to duplicate it in any way without the written permission of Seller. Buyer (at its own expense) shall indemnify and hold harmless Seller and defend or settle any action brought against Seller to the extent that it is based on a claim that any Product made to Buyer specifications infringed intellectual property rights of another party.
- Property/Confidentiality:** Notwithstanding any charges to Buyer for engineering or tooling, all engineering and tooling shall remain the exclusive property of Seller. All information and materials supplied by Seller to Buyer relating to the Products are confidential and proprietary, and Buyer shall limit distribution thereof to its trusted employees and strictly prevent disclosure to any third party.
- Performance Data:** Performance data is provided as a guide in determining suitability and does not constitute a warranty. It may represent the result of Seller's test conditions, and the users must correlate it to actual application requirements.
- Change In Specifications:** Product specifications and descriptions may be changed at any time based on improvements or other reasons. It is Seller's practice to change part numbers when published ratings or features are changed, or when significant engineering changes are made. However, some specifications of the Product may be changed without any notice.
- Errors And Omissions:** The information on Seller's website or in other documentation has been carefully checked and is believed to be accurate; however, no responsibility is assumed for clerical, typographical or proofreading errors or omissions.
- Export Controls:** Buyer shall comply with all applicable laws, regulations and licenses regarding (a) export of the Products or information provided by Seller; (b) sale of Products to forbidden or other proscribed persons or organizations; (c) disclosure to non-citizens of regulated technology or information.

### VI. MISCELLANEOUS

- Waiver:** No failure or delay by Seller in exercising any right and no course of dealing between Buyer and Seller shall operate as a waiver of rights by Seller.
- Assignment:** Buyer may not assign its rights hereunder without Seller's written consent.
- Law:** These Terms are governed by Illinois law (without regard to conflict of laws). Federal and state courts in Cook County, Illinois have exclusive jurisdiction for any dispute hereunder.
- Amendment:** These Terms constitute the entire agreement between Buyer and Seller relating to the Products, and no provision may be changed or waived unless in writing signed by the parties.
- Severability:** If any provision hereof is rendered ineffective or invalid, such provision shall not invalidate any other provision.

# Certain Precautions on Specifications and Use

1. **Suitability for Use.** Seller shall not be responsible for conformity with any standards, codes or regulations which apply to the combination of the Product in Buyer's application or use of the Product. At Buyer's request, Seller will provide applicable third party certification documents identifying ratings and limitations of use which apply to the Product. This information by itself is not sufficient for a complete determination of the suitability of the Product in combination with the end product, machine, system, or other application or use. Buyer shall be solely responsible for determining appropriateness of the particular Product with respect to Buyer's application, product or system. Buyer shall take application responsibility in all cases but the following is a non-exhaustive list of applications for which particular attention must be given:
  - (i) Outdoor use, uses involving potential chemical contamination or electrical interference, or conditions or uses not described in this document.
  - (ii) Energy control systems, combustion systems, railroad systems, aviation systems, medical equipment, amusement machines, vehicles, safety equipment, and installations subject to separate industry or government regulations.
  - (iii) Use in consumer products or any use in significant quantities.
  - (iv) Systems, machines and equipment that could present a risk to life or property. Please know and observe all prohibitions of use applicable to this product.

NEVER USE THE PRODUCT FOR AN APPLICATION INVOLVING SERIOUS RISK TO LIFE OR PROPERTY WITHOUT ENSURING THAT THE SYSTEM AS A WHOLE HAS BEEN DESIGNED TO ADDRESS THE RISKS, AND THAT THE OMRON PRODUCT IS PROPERLY RATED AND INSTALLED FOR THE INTENDED USE WITHIN THE OVERALL EQUIPMENT OR SYSTEM.
2. **Programmable Products.** Seller shall not be responsible for the user's programming of a programmable product, or any consequence thereof.
3. **Performance Data.** Performance data given in this publication is provided as a guide for the user in determining suitability and does not constitute a warranty. It may represent the result of Seller's test conditions, and the users must correlate it to actual application requirements. Actual performance is subject to Seller's Warranty and Limitations of Liability.
4. **Change in Specifications.** Product specifications and accessories may be changed at any time based on improvements and other reasons. It is our practice to change part numbers when published ratings or features are changed, or when significant construction changes are made. However, some specifications of the Product may be changed without any notice. When in doubt, special part numbers may be assigned to fix or establish key specifications for your application. Please consult with your Seller representative at any time to confirm actual specifications of purchased Product.
5. **Errors and Omissions.** The information in this publication has been carefully checked and is believed to be accurate; however, no responsibility is assumed for clerical, typographical or proofreading errors, or omissions.
6. **RoHS Compliance.** Where indicated, our products currently comply, to the best of our knowledge as of the date of this publication, with the requirements of the European Union's Directive on the Restriction of certain Hazardous Substances ("RoHS"), although the requirements of RoHS do not take effect until July 2006. These requirements may be subject to change. Please consult our website for current information.

Complete "Terms and Conditions of Sale" for product purchase and use are on Omron's website at <http://www.components.omron.com> – under the "About Us" tab, in the Legal Matters section.

**ALL DIMENSIONS SHOWN ARE IN MILLIMETERS.**

To convert millimeters into inches, multiply by 0.03937. To convert grams into ounces, multiply by 0.03527.

# OMRON®

**OMRON ELECTRONIC  
COMPONENTS LLC**

55 E. Commerce Drive, Suite B  
Schaumburg, IL 60173

**847-882-2288**

**OMRON ON-LINE**

Global - <http://www.omron.com>

USA - <http://www.components.omron.com>

Cat. No. J175-E-02

09/09

Specifications subject to change without notice

Printed in USA