

Slim Relay G2RV

Industrial Slim Relay Rated at 6 Amps

- Large plug-in terminals for reliable connection.
- LED indicator, clear case, and mechanical flag allows easy and immediate visual operation verification.
- Has a maximum switching voltage of 440 VAC.
- Slim outline to save space in high volume rack and PLC applications.
- Low power consumption for system energy savings.

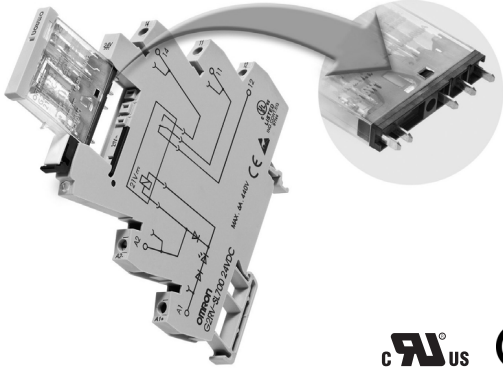

Model Number Structure

Model Number Legend

G2RV-SL □□□□ - □
1 2 3 4 5

1. Auxiliary Type Designation

SL: Slim relay and socket combination

2. Wire Connection

- 7: Screw terminals
- 5: Push-in terminals

3. Relay LED

0: Without LED

4. Relay Pushbutton

0: Without pushbutton

5. Input Voltage

(Complete part numbers listed in the Relay and Socket Combinations Chart below)

Note: LED indicator standard feature on Socket.

Ordering Information

List of Models

Classification		Enclosure rating	Input voltage	Type of connection	Contact form
					SPDT
Plug-in terminals	General-purpose	Unsealed	AC/DC	Screw terminals	G2RV-SL700
				Push-in terminals	G2RV-SL500

Relay and Socket Combinations

Input voltage	Screw terminals	Push-in terminals
12 VDC	G2RV-SL700-DC12(DC11)	G2RV-SL500-DC12(DC11)
24 VDC	G2RV-SL700-DC24(DC21)	G2RV-SL500-DC24(DC21)
24 VAC/DC	G2RV-SL700-AC/DC24	G2RV-SL500-AC/DC24
48 VAC/DC	G2RV-SL700-AC/DC48	G2RV-SL500-AC/DC48
110 VAC	G2RV-SL700-AC110	G2RV-SL500-AC110
230 VAC	G2RV-SL700-AC230	G2RV-SL500-AC230



Note: Relay and Socket Combinations are cUL_{us} listed.

Specifications

■ Coil Ratings @ 23°C

Rated voltage	Rated current			Operate voltage	Release voltage	Power consumption		Input voltage
	AC		DC			% of rated voltage	AC (VA) Approx.	
	50 Hz	60 Hz		% of rated voltage				
12 VDC	---	---	27.2	80% max.	10% min.	---	300 mW	±10%
24 VDC	---	---	13.3			---	300 mW	
24 VAC/DC	21.1	22.5	13.0			0.5 VA	300 mW	
48 VAC/DC	8.5	9.0	5.2			0.4 VA	250 mW	
110 VAC	7.1	7.5	---			0.8 VA	---	
230 VAC	7.3	7.9	---			1.7 VA	---	

■ Contact Ratings

Number of poles	1 pole	
Load	Resistive load ($\cos \phi = 1$)	Inductive load ($\cos \phi = 0.4$, L/R = 7 ms)
Rated load	2A at 400 VAC; 6 A at 250 VAC; 6 A at 30 VDC	2 A at 250 VAC; 2 A at 30 VDC
Rated carry current	6 A	
Max. switching voltage	440 VAC, 125 VDC	
Max. switching current	6 A	
Max. switching power	1,500 VA 180 W	500 VA 60 W
Minimum permissible load	10 mA at 5 VDC : P level: $\lambda_{60} = 0.1 \times 10^{-6}$ /operation	

■ Characteristics

Item	1 pole
Contact resistance	100 mΩ max.
Operate (set) time	20 ms max.
Release time	40 ms max.
Max. operating frequency	Mechanical: 18,000 operations/hr Electrical: 1,800 operations/hr (under rated load)
Insulation resistance	1,000 MΩ min. (at 500 VDC)
Dielectric strength	4,000 VAC, 50/60 Hz for 1 min between coil and contacts 1,000 VAC, 50/60 Hz for 1 min between contacts of same polarity
Vibration resistance	Destruction: 10 to 55 Hz, 1.0 mm double amplitude Malfunction: 10 to 55 Hz, 1.0 mm double amplitude
Shock resistance	Destruction: 1,000 m/s ² (approx. 100G) Malfunction: 100 m/s ² (approx. 10G)
Life expectancy	Mechanical: 5,000,000 operations min. Electrical: 100,000 typical; NO 70,000 operations min.; NC 50,000 operations min.
Ambient temperature	Operating: -40°C to 55°C (with no icing or condensation)
Ambient humidity	Operating: 5% to 85%
Weight	Approx. 35 g
Overvoltage category	III
Pollution degree	2

Note: Data shown are of initial values.

Switching Timing

Model number	Operating time (typical)	Release time (typical)
G2RV-SL7□□/5□□ DC12	5 ~ 7 ms	5 ~ 8 ms
G2RV-SL7□□/5□□ DC24	5 ~ 7 ms	5 ~ 8 ms
G2RV-SL7□□/5□□ AC/DC24	5 ~ 7 ms	17 ~ 22ms
G2RV-SL7□□/5□□ AC/DC48	5 ~ 7 ms	22 ~ 30 ms
G2RV-SL7□□/5□□ AC110	12 ~ 15 ms	22 ~ 30 ms
G2RV-SL7□□/5□□ AC230	12 ~ 15 ms	22 ~ 30 ms

■ Approved Standards

UL 508 (File No. E41643)

Model	Contact form	Coil ratings	Contact ratings	Operations
G2RV-SL Series	SPDT	12 to 48 VDC 24 to 230 VAC	250 VAC 6 A (Resistive Load) 30 VDC 6 A (Resistive Load) 400 VAC 2 A (Resistive Load)	6,000

IEC/VDE (EN 61810)

Contact form	Coil ratings	Contact ratings	Operations
1 pole	12, 24 VDC 24, 48 VAC/DC 110, 230 VAC	250 VAC 6 A (Res.) 30 VDC 6 A (Res.) 400 VAC 2 A (Res.)	50,000 50,000 6,000

Accessories

■ PLC Interface (for G2RV-SL700 series only)

List of Models

Model number	Description	Connection
P2RVC-8-O-F	For output use	Flat cable

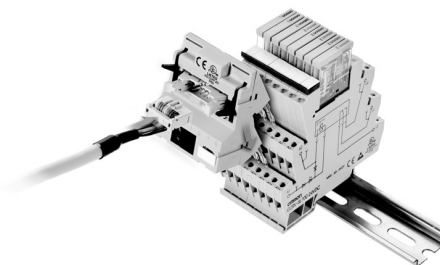

Specifications

Input	Rated voltage	30 VAC/VDC max.
	Current capacity	0.5 A per channel 2.0 A total current, power supply terminal
Characteristics	Ambient temperature	Operating: 0 to 55°C Storage: -20 to 85°C
	Overvoltage category	III
	Pollution degree	2

Electrical schematic P2RVC-8-O-F

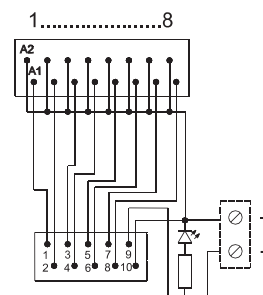

■ Cables for PLC Interface P2RVC-8-O-F

P2RV-4-□□□C

Cable to connect CJ1 to 4 x P2RVC-8-O-F

List of Models

Model number	Cable length
P2RV-4-100C	1.0 m
P2RV-4-200C	2.0 m
P2RV-4-300C	3.0 m
P2RV-4-500C	5.0 m

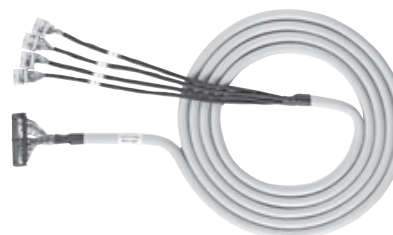

4x10 pole IDC mounting to 4 x P2RVC-8-O-F

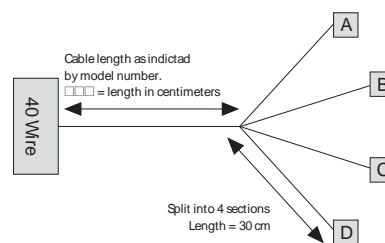
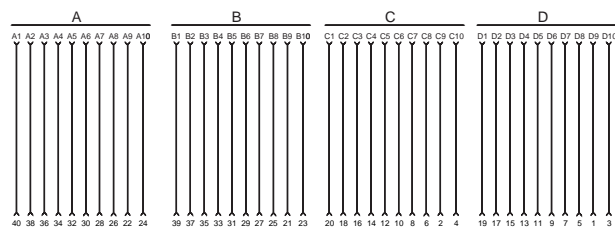

40 pole IDC mounting to Omron PLC CJ1-OD232

Technical data

Control line	AWG26/0.14 mm ² , tin-plated copper
Diameter cable	10.6 mm (one end splits into 4 sections: A, B, C, D)
Operating voltage	60 VDC
Continuous current per signal wire	0.5 A
Max. total current, 4 bytes, each	1.0 A
Test voltage	0.5 KV, 50 Hz, 1 min
Operating temperature range	-20°C to +50°C

P2RV-A□□□C

Cable, single sided 10 pole IDC connector, to connect to P2RVC-8-O-F

List of Models

Model number	Cable length
P2RV-A100C	1.0 m
P2RV-A200C	2.0 m
P2RV-A300C	3.0 m
P2RV-A500C	5.0 m

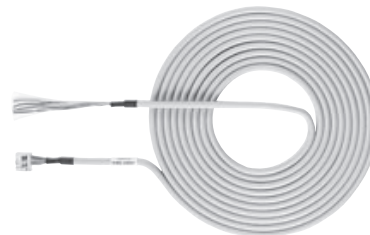

10 pole IDC mounting to P2RVC-8-O-F

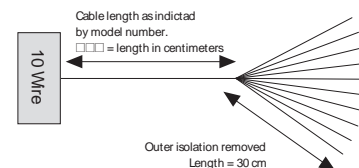
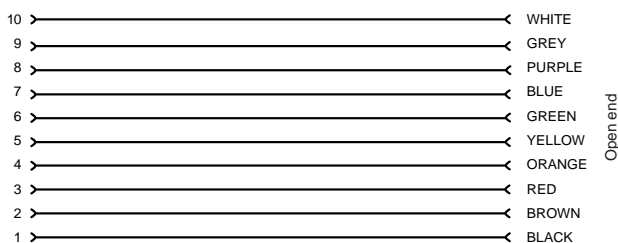

Technical data

Control line	AWG26/0.14 mm ² , tin-plated copper
Diameter cable	6.8 mm
Operating voltage	60 VDC
Continuous current per signal wire	0.5 A
Max. total current	1.0 A
Test voltage	0.5 KV, 50 Hz, 1 min
Operating temperature range	-20°C to +50°C

■ Stand-Alone Relays for MRO and Reference

Model Number Legend

G2RV-□ - □□□ DC□
 1 2 3 4 5

1. Number of Poles

1: 1 pole

2. Terminals

S: Plug-In

3. Relay LED

Blank: Without LED

4. Contact Material

Blank: AgSnIn

5. Rated Coil Voltage

11, 21, 48

List of Models

Model number	Replacement for
G2RV-1-S DC11	G2RV-SL7□□/5□□ DC12(DC11)
G2RV-1-S DC21	G2RV-SL7□□/5□□ DC24(DC21)
	G2RV-SL7□□/5□□ AC/DC24
G2RV-1-S DC48	G2RV-SL7□□/5□□ AC/DC48
	G2RV-SL7□□/5□□ AC110
	G2RV-SL7□□/5□□ AC230



Accessories (Order Separately)

■ Cross Bars

Model Number Legend

P2RVM-□□
1 2

1. Number of Poles

- 020: 2 poles
- 030: 3 poles
- 040: 4 poles
- 100: 10 poles
- 200: 20 poles

2. Color

- R:Red
- S:Blue
- B:Black

Model number	Poles	Color
P2RVM-020□	2	Red (R) Blue (S) Black (B)
P2RVM-030□	3	
P2RVM-040□	4	
P2RVM-100□	10	
P2RVM-200□	20	

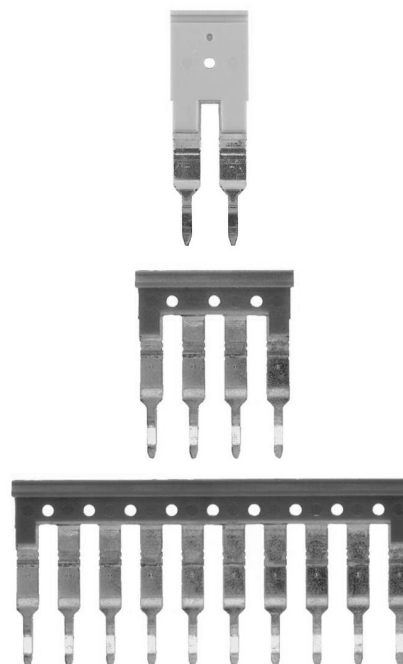

■ Plastic Labels for G2RV Sockets

Model number	Quantity	Color
R99-15 for G2RV	5 sheets x 120 labels = 600 labels (minimum order)	White

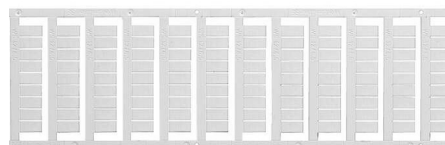

■ Labels (Stickers) for G2RV Sockets

Model number	Quantity	Color
R99-16 for G2RV	10 sheets x 484 labels = 4,840 labels (minimum order)	White

■ Separating Plates

Model number	Quantity	Description
P2RV-S	50 plates (minimum order)	Provides isolation between adjacent relays to achieve 400 V isolation.

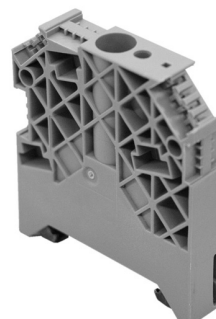

Dimensions

Note: All units are in millimeters unless otherwise indicated.

■ Complete Unit

G2RV-SL700

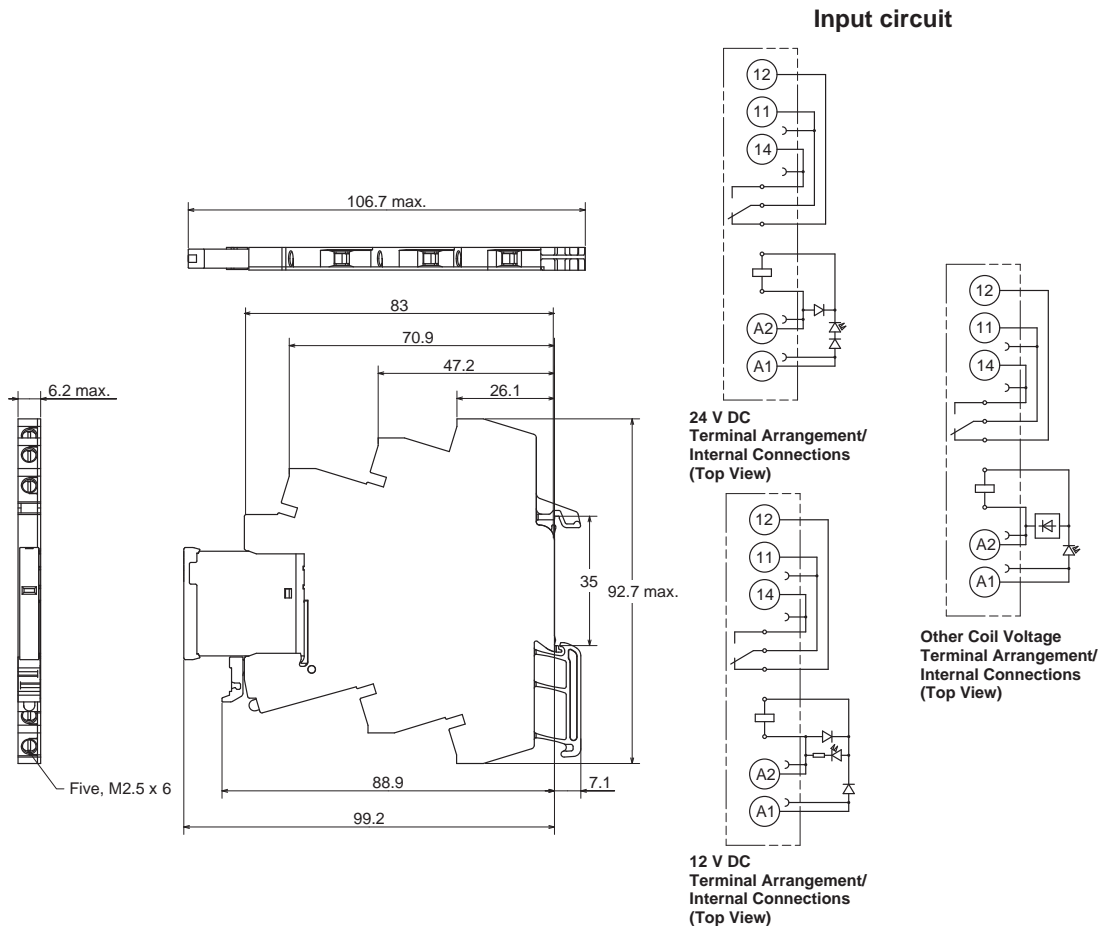

Input circuit

24 V DC Terminal Arrangement/Internal Connections (Top View)

12 V DC Terminal Arrangement/Internal Connections (Top View)

Other Coil Voltage Terminal Arrangement/Internal Connections (Top View)

G2RV-SL500

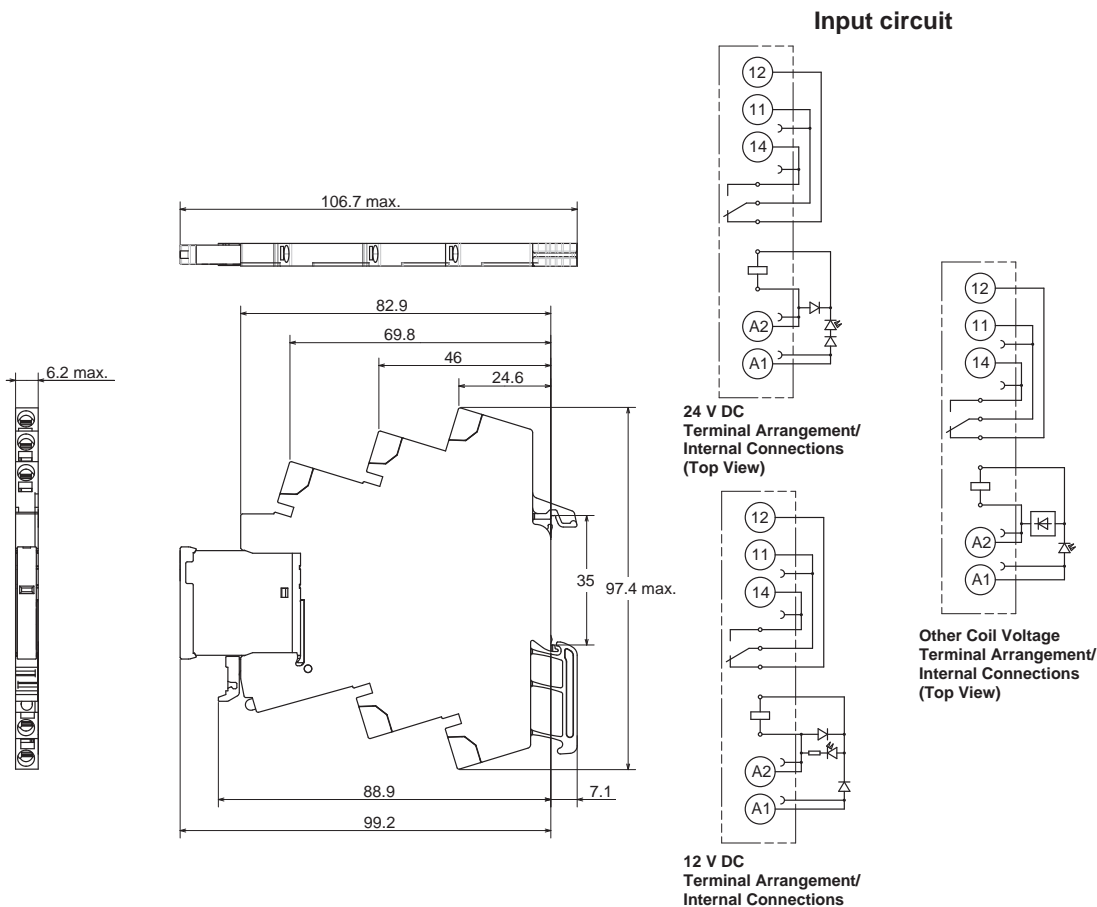

■ **Single Relay**

G2RV-1-S

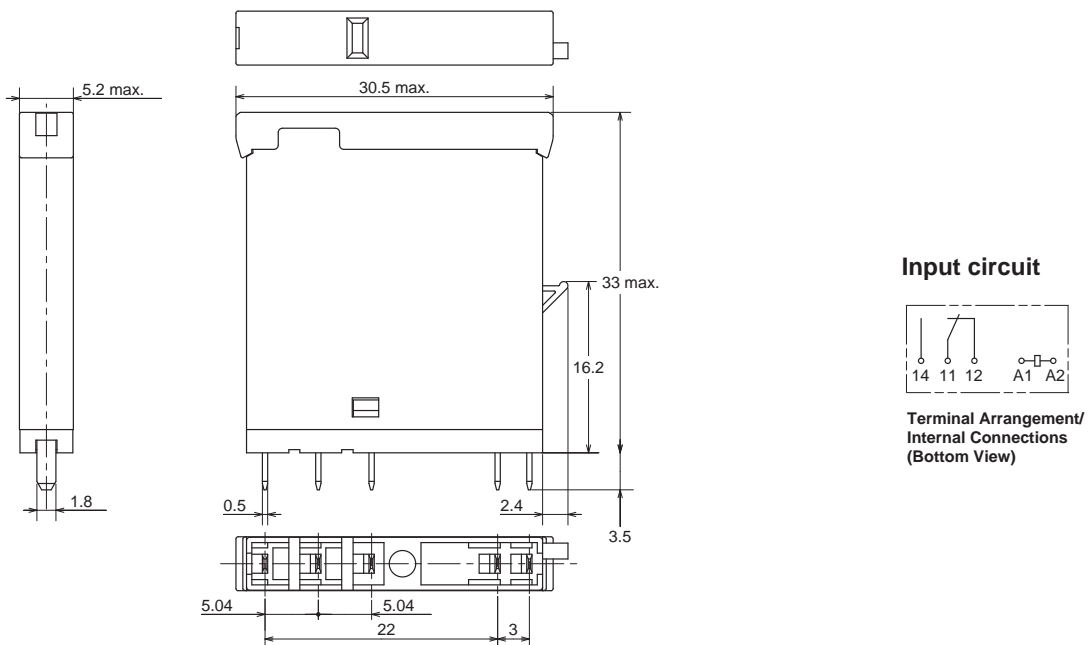

Installation

■ Tools

G2RV-SL700 series: Flat-blade screwdriver should be used for mounting and / or releasing cables.

G2RV-SL500 series: Flat-blade screwdriver should be used for mounting stranded wires without ferrules and / or releasing cables.

Applicable Screwdriver

- Flat-blade, Parallel-tip, 2.5 mm diameter (3.0 mm max.)

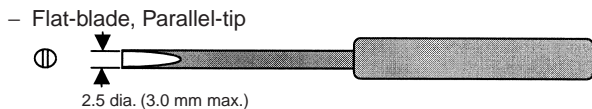

Examples: FACOM AEF.2.5x75E (AEF. 3x75E)
 VESSEL No. 9900(-)2.5x75 (No. 9900(-)3x100)
 WAGO 210-119
 WIHA 260/2.5x40 (260/3x50)

*Chamfering the tip of the driver improves insertion when used as an exclusive tool.

■ Applicable Wires

Applicable Wire Sizes

G2RV-SL700 Series

Box Clamp Technology

Wire type	Applicable Wire Size	Stripping Length
Stranded without ferrules	0.5 - 2.5 mm ²	7 mm
Stranded with ferrules and plastic collar	0.5 - 2.5 mm ²	7 mm
Stranded with ferrules without plastic collar	0.5 - 2.5 mm ²	7 mm
Solid	0.5 - 4.0 mm ²	7 mm

G2RV-SL500 Series

Push-in Technology

Wire type	Applicable Wire Size	Stripping Length
Stranded without ferrules	0.5 - 2.5 mm ²	12 mm
Stranded with ferrules and plastic collar	0.5 - 2.5 mm ²	12 mm
Stranded with ferrules without plastic collar	0.5 - 2.5 mm ²	12 mm
Solid	0.5 - 4.0 mm ²	12 mm

■ Wiring

Use wires of the applicable sizes specified above. The length of the exposed conductor should be 7 mm for a G2RV-SL700 series, 12 mm for a G2RV-SL500 series.

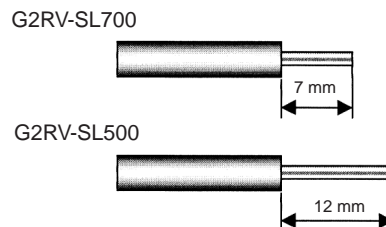

Fig. 1 Exposed Conductor Length

Precautions

■ Precautions for Connection

- Do not move the screwdriver up, down, or from side to side while it is inserted in the hole. Doing so may cause damage to internal components (e.g., deformation of the clamp spring or cracks in the housing) or cause deterioration of insulation.
- Do not insert the screwdriver at an angle. Doing so may break the side of socket and result in a short-circuit.
- Do not insert two or more wires in the hole. Wires may come in contact with the spring causing a temperature rise or be subject to sparks. (There are two wiring holes for each terminal.)
- Insert the screwdriver along the hole wall as shown below.
- If lubricating liquid, such as oil, is present on the tip of screwdriver, the screwdriver may fall out resulting in injury to the operator.
- Insert the screwdriver into the bottom of the hole. It may not be possible to connect cables properly if the screwdriver is inserted incorrectly.

■ General Precautions

- Do not use the product if it has been dropped on the ground. Dropping the product may adversely affect performance.
- Confirm that the socket is securely attached to the mounting track before wiring. If the socket is mounted insecurely it may fall and injure the operator.
- Insure that the socket is not charged during wiring and maintenance. Not doing so may result in electric shock.
- Do not pour water or cleansing agents on the product. Doing so may result in electric shock.
- Do not use the socket in locations subject to solvents or alkaline chemicals.
- Do not use the socket in locations subject to ultraviolet light (e.g., direct sunlight). Doing so may result in markings fading, rust, corrosion, or resin deterioration.
- Do not dispose of the product in fire.

■ Removing from Mounting Rail

To remove the socket from the mounting rail, insert the tip of screwdriver in the fixture rail, and move it in the direction shown below.

■ Wiring Procedure for G2RV-SL500 series

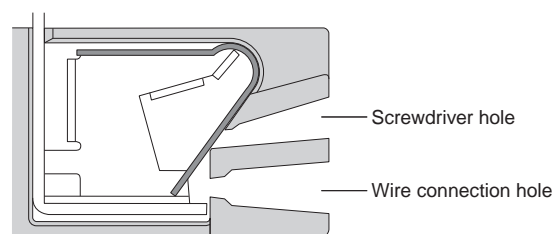

Wire insertion

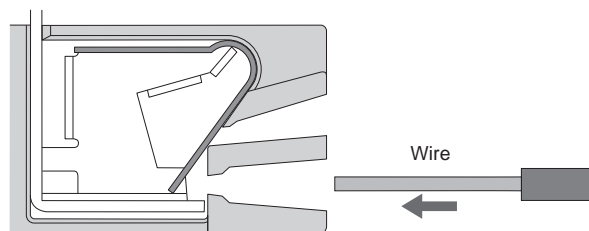

Insert the exposed conductor into the connection hole.

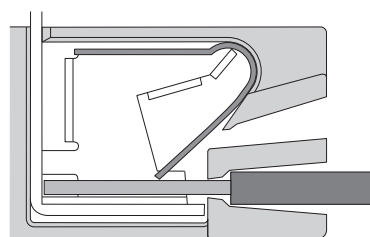

No other tools are required.

Note: In case of wiring stranded wires without ferrules screwdriver should be inserted before inserting the wire. Screwdriver should be removed after fully insertion of the wire.

Wire removal

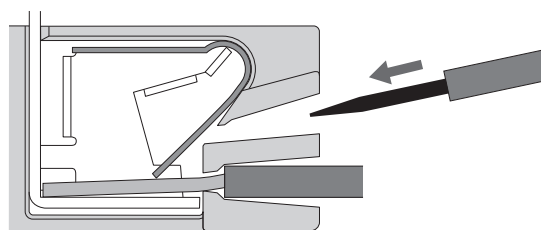

Insert the specified screwdriver into the release hole.

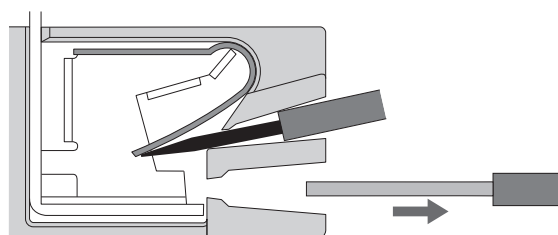

Removing wire.

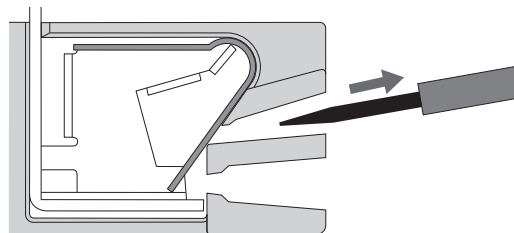

Removing screwdriver.

Terms and Conditions of Sale

- Offer; Acceptance.** These terms and conditions (these "Terms") are deemed part of all quotes, agreements, purchase orders, acknowledgments, price lists, catalogs, manuals, brochures and other documents, whether electronic or in writing, relating to the sale of products or services (collectively, the "Products") by Omron Electronics LLC and its subsidiary companies ("Omron"). Omron objects to any terms or conditions proposed in Buyer's purchase order or other documents which are inconsistent with, or in addition to, these Terms.
- Prices; Payment Terms.** All prices stated are current, subject to change without notice by Omron. Omron reserves the right to increase or decrease prices on any unshipped portions of outstanding orders. Payments for Products are due net 30 days unless otherwise stated in the invoice.
- Discounts.** Cash discounts, if any, will apply only on the net amount of invoices sent to Buyer after deducting transportation charges, taxes and duties, and will be allowed only if (i) the invoice is paid according to Omron's payment terms and (ii) Buyer has no past due amounts.
- Interest.** Omron, at its option, may charge Buyer 1-1/2% interest per month or the maximum legal rate, whichever is less, on any balance not paid within the stated terms.
- Orders.** Omron will accept no order less than \$200 net billing.
- Governmental Approvals.** Buyer shall be responsible for, and shall bear all costs involved in, obtaining any government approvals required for the importation or sale of the Products.
- Taxes.** All taxes, duties and other governmental charges (other than general real property and income taxes), including any interest or penalties thereon, imposed directly or indirectly on Omron or required to be collected directly or indirectly by Omron for the manufacture, production, sale, delivery, importation, consumption or use of the Products sold hereunder (including customs duties and sales, excise, use, turnover and license taxes) shall be charged to and remitted by Buyer to Omron.
- Financial.** If the financial position of Buyer at any time becomes unsatisfactory to Omron, Omron reserves the right to stop shipments or require satisfactory security or payment in advance. If Buyer fails to make payment or otherwise comply with these Terms or any related agreement, Omron may (without liability and in addition to other remedies) cancel any unshipped portion of Products sold hereunder and stop any Products in transit until Buyer pays all amounts, including amounts payable hereunder, whether or not then due, which are owing to it by Buyer. Buyer shall in any event remain liable for all unpaid accounts.
- Cancellation; Etc.** Orders are not subject to rescheduling or cancellation unless Buyer indemnifies Omron against all related costs or expenses.
- Force Majeure.** Omron shall not be liable for any delay or failure in delivery resulting from causes beyond its control, including earthquakes, fires, floods, strikes or other labor disputes, shortage of labor or materials, accidents to machinery, acts of sabotage, riots, delay in or lack of transportation or the requirements of any government authority.
- Shipping; Delivery.** Unless otherwise expressly agreed in writing by Omron:
 - Shipments shall be by a carrier selected by Omron; Omron will not drop ship except in "break down" situations.
 - Such carrier shall act as the agent of Buyer and delivery to such carrier shall constitute delivery to Buyer;
 - All sales and shipments of Products shall be FOB shipping point (unless otherwise stated in writing by Omron), at which point title and risk of loss shall pass from Omron to Buyer; provided that Omron shall retain a security interest in the Products until the full purchase price is paid;
 - Delivery and shipping dates are estimates only; and
 - Omron will package Products as it deems proper for protection against normal handling and extra charges apply to special conditions.
- Claims.** Any claim by Buyer against Omron for shortage or damage to the Products occurring before delivery to the carrier must be presented in writing to Omron within 30 days of receipt of shipment and include the original transportation bill signed by the carrier noting that the carrier received the Products from Omron in the condition claimed.
- Warranties.** (a) **Exclusive Warranty.** Omron's exclusive warranty is that the Products will be free from defects in materials and workmanship for a period of twelve months from the date of sale by Omron (or such other period expressed in writing by Omron). Omron disclaims all other warranties, express or implied. (b) **Limitations.** OMRON MAKES NO WARRANTY OR REPRESENTATION, EXPRESS OR IMPLIED, ABOUT NON-INFRINGEMENT, MERCHANTABILITY OR FITNESS FOR A PARTICULAR PURPOSE OF THE PRODUCTS. BUYER ACKNOWLEDGES THAT IT ALONE HAS DETERMINED THAT THE PRODUCTS WILL SUITABLY MEET THE REQUIREMENTS OF THEIR INTENDED USE. Omron further disclaims all warranties and responsibility of any type for claims or expenses based on infringement by the Products or otherwise of any intellectual property right. (c) **Buyer Remedy.** Omron's sole obligation hereunder shall be, at Omron's election, to (i) replace (in the form originally shipped with Buyer responsible for labor charges for removal or replacement thereof) the non-complying Product, (ii) repair the non-complying Product, or (iii) repay or credit Buyer an amount equal to the purchase price of the non-complying Product; provided that in no event shall Omron be responsible for warranty, repair, indemnity or any other claims or expenses regarding the Products unless Omron's analysis confirms that the Products were properly handled, stored, installed and maintained and not subject to contamination, abuse, misuse or inappropriate modification. Return of any Products by Buyer must be approved in writing by Omron before shipment. Omron Companies shall not be liable for the suitability or unsuitability or the results from the use of Products in combination with any electrical or electronic components, circuits, system assemblies or any other materials or substances or environments. Any advice, recommendations or information given orally or in writing, are not to be construed as an amendment or addition to the above warranty. See <http://www.omron247.com> or contact your Omron representative for published information.
- Limitation on Liability; Etc.** OMRON COMPANIES SHALL NOT BE LIABLE FOR SPECIAL, INDIRECT, INCIDENTAL, OR CONSEQUENTIAL DAMAGES, LOSS OF PROFITS OR PRODUCTION OR COMMERCIAL LOSS IN ANY WAY CONNECTED WITH THE PRODUCTS, WHETHER SUCH CLAIM IS BASED IN CONTRACT, WARRANTY, NEGLIGENCE OR STRICT LIABILITY. Further, in no event shall liability of Omron Companies exceed the individual price of the Product on which liability is asserted.
- Indemnities.** Buyer shall indemnify and hold harmless Omron Companies and their employees from and against all liabilities, losses, claims, costs and expenses (including attorney's fees and expenses) related to any claim, investigation, litigation or proceeding (whether or not Omron is a party) which arises or is alleged to arise from Buyer's acts or omissions under these Terms or in any way with respect to the Products. Without limiting the foregoing, Buyer (at its own expense) shall indemnify and hold harmless Omron and defend or settle any action brought against such Companies to the extent based on a claim that any Product made to Buyer specifications infringed intellectual property rights of another party.
- Property; Confidentiality.** Any intellectual property in the Products is the exclusive property of Omron Companies and Buyer shall not attempt to duplicate it in any way without the written permission of Omron. Notwithstanding any charges to Buyer for engineering or tooling, all engineering and tooling shall remain the exclusive property of Omron. All information and materials supplied by Omron to Buyer relating to the Products are confidential and proprietary, and Buyer shall limit distribution thereof to its trusted employees and strictly prevent disclosure to any third party.
- Export Controls.** Buyer shall comply with all applicable laws, regulations and licenses regarding (i) export of products or information; (ii) sale of products to "forbidden" or other proscribed persons; and (iii) disclosure to non-citizens of regulated technology or information.
- Miscellaneous.** (a) **Waiver.** No failure or delay by Omron in exercising any right and no course of dealing between Buyer and Omron shall operate as a waiver of rights by Omron. (b) **Assignment.** Buyer may not assign its rights hereunder without Omron's written consent. (c) **Law.** These Terms are governed by the law of the jurisdiction of the home office of the Omron company from which Buyer is purchasing the Products (without regard to conflict of law principles). (d) **Amendment.** These Terms constitute the entire agreement between Buyer and Omron relating to the Products, and no provision may be changed or waived unless in writing signed by the parties. (e) **Severability.** If any provision hereof is rendered ineffective or invalid, such provision shall not invalidate any other provision. (f) **Setoff.** Buyer shall have no right to set off any amounts against the amount owing in respect of this invoice. (g) **Definitions.** As used herein, "including" means "including without limitation"; and "Omron Companies" (or similar words) mean Omron Corporation and any direct or indirect subsidiary or affiliate thereof.

Certain Precautions on Specifications and Use

- Suitability of Use.** Omron Companies shall not be responsible for conformity with any standards, codes or regulations which apply to the combination of the Product in the Buyer's application or use of the Product. At Buyer's request, Omron will provide applicable third party certification documents identifying ratings and limitations of use which apply to the Product. This information by itself is not sufficient for a complete determination of the suitability of the Product in combination with the end product, machine, system, or other application or use. Buyer shall be solely responsible for determining appropriateness of the particular Product with respect to Buyer's application, product or system. Buyer shall take application responsibility in all cases but the following is a non-exhaustive list of applications for which particular attention must be given:
 - Outdoor use, uses involving potential chemical contamination or electrical interference, or conditions or uses not described in this document.
 - Use in consumer products or any use in significant quantities.
 - Energy control systems, combustion systems, railroad systems, aviation systems, medical equipment, amusement machines, vehicles, safety equipment, and installations subject to separate industry or government regulations.
 - Systems, machines and equipment that could present a risk to life or property. Please know and observe all prohibitions of use applicable to this Product.

NEVER USE THE PRODUCT FOR AN APPLICATION INVOLVING SERIOUS RISK TO LIFE OR PROPERTY OR IN LARGE QUANTITIES WITHOUT ENSURING THAT THE SYSTEM AS A WHOLE HAS BEEN DESIGNED TO
- ADDRESS THE RISKS, AND THAT THE OMRON'S PRODUCT IS PROPERLY RATED AND INSTALLED FOR THE INTENDED USE WITHIN THE OVERALL EQUIPMENT OR SYSTEM.
- Programmable Products.** Omron Companies shall not be responsible for the user's programming of a programmable Product, or any consequence thereof.
- Performance Data.** Data presented in Omron Company websites, catalogs and other materials is provided as a guide for the user in determining suitability and does not constitute a warranty. It may represent the result of Omron's test conditions, and the user must correlate it to actual application requirements. Actual performance is subject to the Omron's Warranty and Limitations of Liability.
- Change in Specifications.** Product specifications and accessories may be changed at any time based on improvements and other reasons. It is our practice to change part numbers when published ratings or features are changed, or when significant construction changes are made. However, some specifications of the Product may be changed without any notice. When in doubt, special part numbers may be assigned to fix or establish key specifications for your application. Please consult with your Omron's representative at any time to confirm actual specifications of purchased Product.
- Errors and Omissions.** Information presented by Omron Companies has been checked and is believed to be accurate; however, no responsibility is assumed for clerical, typographical or proofreading errors or omissions.

OMRON

Automation...simple...powerful.

OMRON ELECTRONICS LLC • THE AMERICAS HEADQUARTERS

Schaumburg, IL USA • 847.843.7900 • 800.556.6766 • www.omron247.com

OMRON CANADA, INC. • HEAD OFFICE

Toronto, ON, Canada • 416.286.6465 • 866.986.6766 • www.omron.ca

OMRON ELETRÔNICA DO BRASIL LTDA • HEAD OFFICE

São Paulo, SP, Brasil • 55.11.2101.6300 • www.omron.com.br

OMRON ELECTRONICS MEXICO SA DE CV • HEAD OFFICE

Apodaca, N.L. • 52.811.156.99.10 • mela@omron.com

J01C-E-01a

Note: Specifications are subject to change.

OMRON ARGENTINA • SALES OFFICE

Cono Sur • 54.11.4787.1129

OMRON CHILE • SALES OFFICE

Santiago 56.2206.4592

OTHER OMRON LATIN AMERICA SALES

56.2206.4592

© 2008 Omron Electronics LLC

Printed in U.S.A.