

STMicroelectronics

# ST7MDTULS-EVAL ST7 USB low-speed evaluation board

UM0068  
User manual

Rev 2

October 2007



BLANK



## Introduction

The objective of the ST7MDTULS-EVAL evaluation board is to provide a complete USB application package using a Windows-based host software application and one of ST's range of USB low-speed microcontrollers acting as a peripheral device. The host software and the ST7 source code provide an easily-understood example of how to exchange data using the HID (human interface devices) class protocols. The firmware supplied on the ST7 devices is based on a USB core library that makes the control of all the USB interface hardware transparent to the application developer. This USB library, developed by STMicroelectronics and plug-tested by the USB IF (implementers forum), is intended for you to use as a toolbox. All the documentation you need to do this is supplied with the package.

The ST7MDTULS-EVAL evaluation board incorporates basic input sources such as push-buttons, an analog trimmer and output sources (LEDs). It also has a wire-wrap area so that you can easily develop your own application. An external 12 V charge pump is also provided, to allow you to program the ST7 embedded Flash program memory using in-application programming (IAP). The following development tools can be ordered separately: assembler, linker, C compiler, source level debugger, hardware emulator, programming boards and gang programmer. For ordering information, see our website at [www.st.com](http://www.st.com) or contact your local sales office.

# Contents

<b>Introduction</b> .....	<b>1</b>
<b>1 Getting started</b> .....	<b>5</b>
1.1 System requirements .....	5
1.2 Package contents .....	5
1.3 Software installation .....	5
1.4 Hardware installation .....	6
1.4.1 Power supply .....	6
1.4.2 Jumper settings .....	6
1.4.3 Device selection .....	7
<b>2 Running the USB low speed evaluation board</b> .....	<b>8</b>
2.1 Introduction .....	8
2.2 HID demonstrator .....	9
2.2.1 USB enumeration .....	9
2.2.2 Communication with the evaluation board .....	9
2.3 Remote wake-up function .....	10
2.4 Adding circuitry on the wire-wrap area .....	10
2.5 Enabling board for ICC communication .....	13
<b>3 Revision history</b> .....	<b>14</b>

## List of tables

Table 1.	Description of evaluation board probing points .....	10
Table 2.	Document revision history .....	14

---

## List of figures

Figure 1.	Evaluation board layout .....	6
Figure 2.	Device selection for analog-to-digital conversion .....	7
Figure 3.	Enumeration result .....	8
Figure 4.	HID demonstrator window .....	9
Figure 5.	HID demonstrator window .....	10
Figure 6.	Board schematics .....	12
Figure 7.	Recommended board modifications for ICC communication .....	13

# 1 Getting started

## 1.1 System requirements

In order to use the ST7MDTULS-EVAL with the Windows operating system, a recent version of Windows, such as Windows 98, Windows Millennium, Windows 2000, or Windows XP must be installed on the PC.

The version of the Windows OS installed on your PC may be determined by clicking on the "System" icon in the Control Panel.

**Caution:** When running the HID evaluation board applet provided in the package, verify that the correct version of the HID.dll file is installed:

- Windows 98: HID.dll - Version 4.10.1998
- Windows 98 SE: HID.dll - Version 4.10.2222
- Windows Millennium: HID.dll - Version 4.90.300.1
- Windows 2000: HID.dll - Version 5.00.2134.1
- Windows XP: HID.dll - Version 5.1.2600.0

## 1.2 Package contents

The USB evaluation low-speed board package includes the following items:

- Hardware content
  - Two ST72 Low-speed USB microcontroller devices:
    - ST7262xxx devices in SDIP42 package
    - ST7263Bxx devices in SDIP32 packageBoth devices are FLASH devices allowing up to 100 reprogramming cycles. They are delivered already programmed with the demonstration firmware.
  - One evaluation board
- Software content
  - PC executable software for demonstrating HID transfers.
  - ST7 firmware (C source code) for the ST7262xxx devices
  - ST7 firmware (C source code) for the ST7263Bxx devices
- Documentation
  - USB library 4 x Interface documentation.
  - ST7262 and ST7263Bxx datasheets
  - Application note AN1325

## 1.3 Software installation

Run USBDemonstrator.exe to install the PC HID demonstrator, and follow the on-screen prompts to complete the installation.

## 1.4 Hardware installation

*Figure 1* shows the location of the main components of the evaluation board. The schematic drawing is given in *Figure 6*.

**Figure 1. Evaluation board layout**

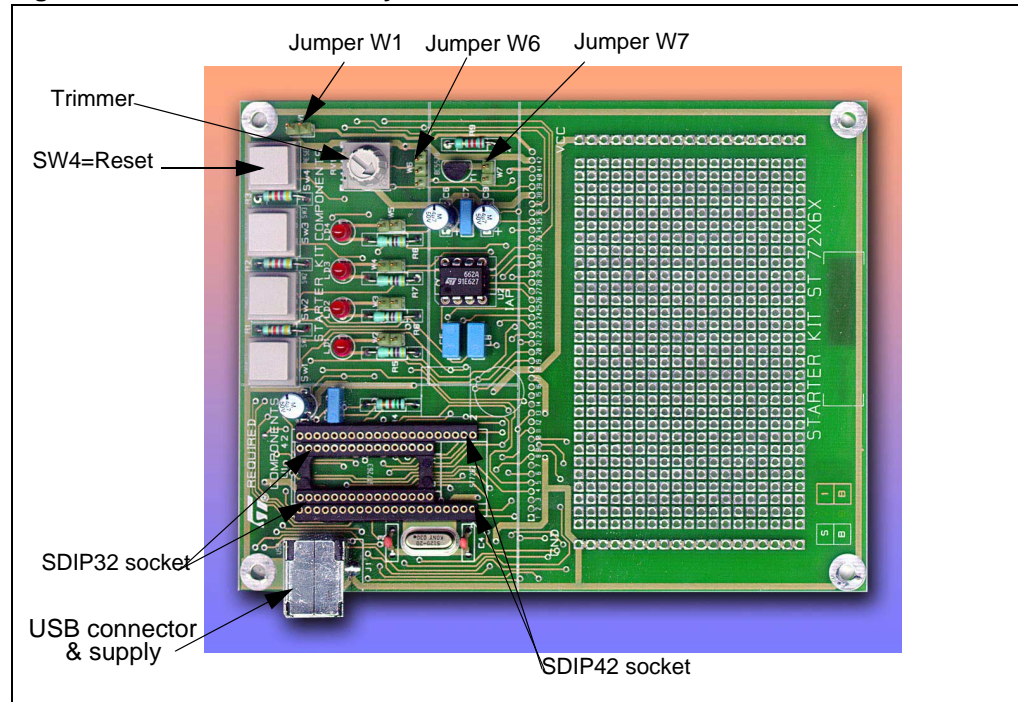

### 1.4.1 Power supply

The evaluation board is directly supplied by the USB Connector (bus powered) and therefore does not require any external supply. In case the components added on the wire-wrap area sink more than 500mA, an external power supply must be used.

### 1.4.2 Jumper settings

The W1 jumper selects the analog trimmer. When the jumper is removed, the analog trimmer is disconnected from Ground in order to stop power consumption and to meet the power specifications of USB suspend state. If analog-to-digital conversion is needed for application development, you can replace this jumper by a switch transistor controlled by an I/O pin.

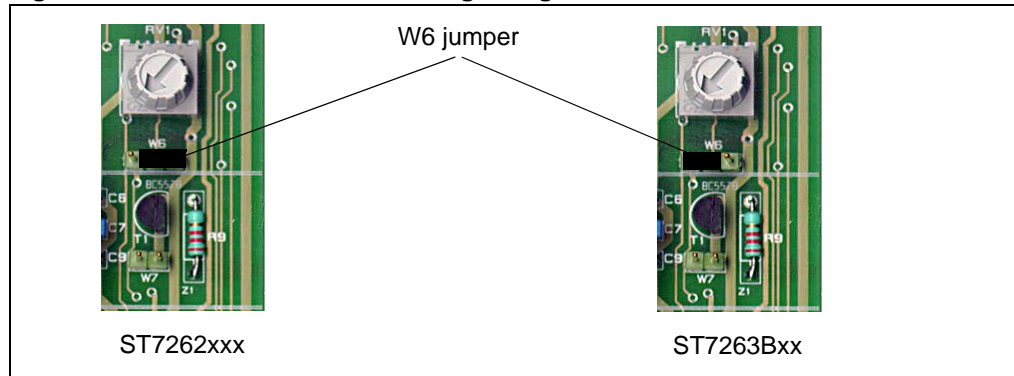

**Figure 2. Device selection for analog-to-digital conversion**

If you are using the analog trimmer, select the installed ST7 device using jumper W6 as shown in [Figure 2](#). This ties the analog trimmer to the PA0 I/O port of the ST7262xxx devices and to the PB0 port of the ST7263Bxx devices. Any other analog input pin on the microcontroller can be used by removing the W6 jumper and wiring the center pin of W6 to the analog input.

The W7 jumper can be used to connect or disconnect an external 12V charge pump in case you want to program the Flash.

### 1.4.3 Device selection

Three devices can be used with this board:

- ST7263Bxx devices in SDIP32 package on the internal socket
- ST7262xxx devices in SDIP42 package on the external socket

## 2 Running the USB low speed evaluation board

### 2.1 Introduction

The USB low-speed evaluation board application consists of two main parts: a HID demonstrator running on a PC and the evaluation board itself.

Communications between the PC and the ST7 board are done through different USB pipes:

- Control IN and OUT during enumeration with the bi-directional Endpoint 0.
- Interrupt IN from endpoint 1 for data transferred from the ST7 to the PC.
- Interrupt OUT to endpoint 2 for the data transferred from the PC to the ST7. Note that the Windows98 HID driver does not support interrupt OUT transfers, and automatically uses the control OUT pipe to endpoint 0 instead (Set-Output function).

First connect the evaluation board to the PC with the USB cable. As a result, the evaluation board is enumerated as an HID device as shown in [Figure 3](#), and is ready to use.

**Figure 3. Enumeration result**

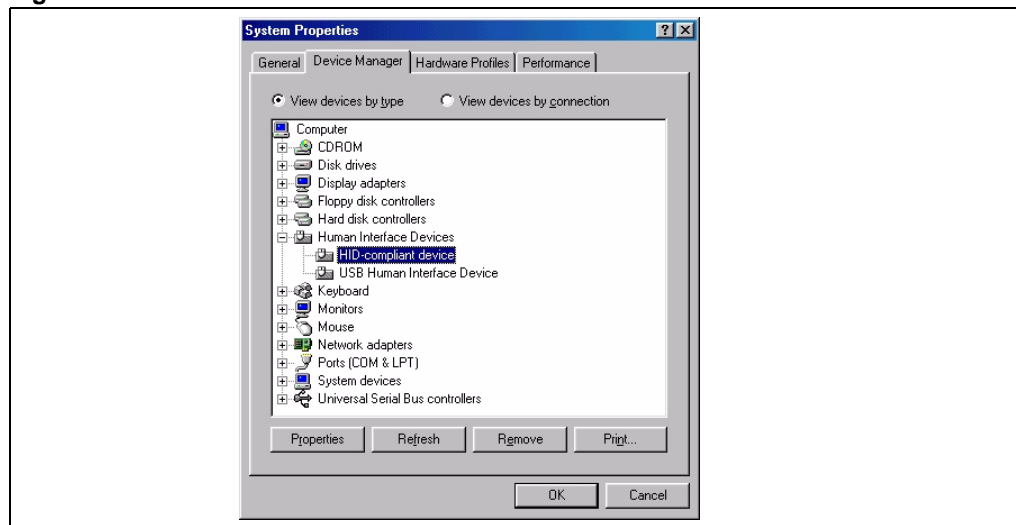

When you start the HID demonstrator on the PC, a graphical interface is displayed (see [Figure 3](#)) for controlling the evaluation board. This PC software is used to demonstrate the enumeration process and data transfer between the PC and the ST7 peripheral according to the USB HID class specifications.

## 2.2 HID demonstrator

### 2.2.1 USB enumeration

The device selection tabsheet, shown in [Figure 4](#), displays the following information:

- Available USB HID devices: All the HID devices connected to the PC are displayed in this window.
- Device information

This information, obtained during the enumeration phase, refers to the highlighted device in the “Available USB HID device” window: vendor ID, product ID and version numbers (refer to the USB Specification version 1.1 or higher). In addition, as string information is supported, the manufacturer name, product and serial number are displayed.

**Figure 4. HID demonstrator window**

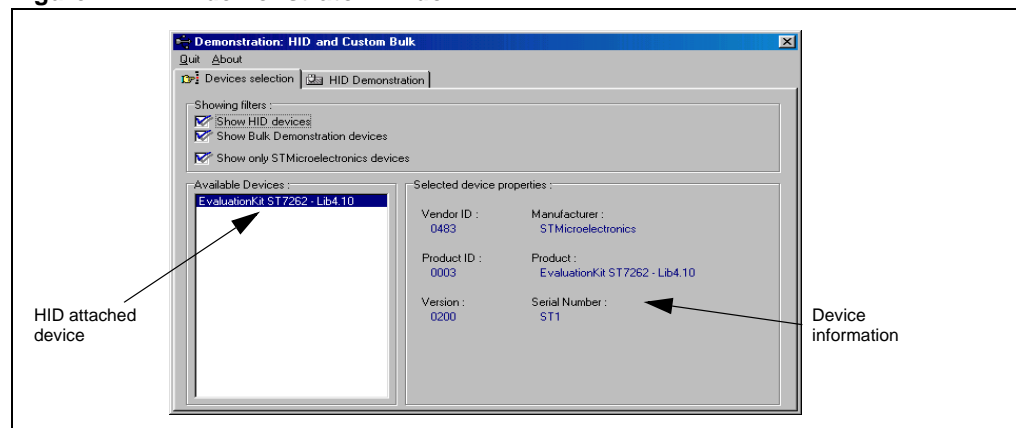

### 2.2.2 Communication with the evaluation board

#### Controlling the evaluation board from a host PC

The HID demonstration tabsheet, shown in [Figure 5](#), displays the following information:

- Click on the ON/OFF button in the application dialog box to switch on the LED LD2 on the board.
- Click again to switch it OFF.
- The slider bar controls the brightness of a LED LD3 (ST7262xxx) or LD1 (ST7263Bxx). Each slider bar value will be converted to a pulse width modulation (PWM) signal by the microcontroller.

#### Displaying the evaluation board state

- Button state: this red LED changes its state when you press the SW1 push button on the evaluation board.
- Trimmer value: this value is the result of the analog-to-digital conversion of the RV1 trimmer output. When you turn the trimmer on the evaluation board to a different position, the new ADC value is transmitted via the USB bus and displayed on the progress bar of the HID demonstrator.

Figure 5. HID demonstrator window

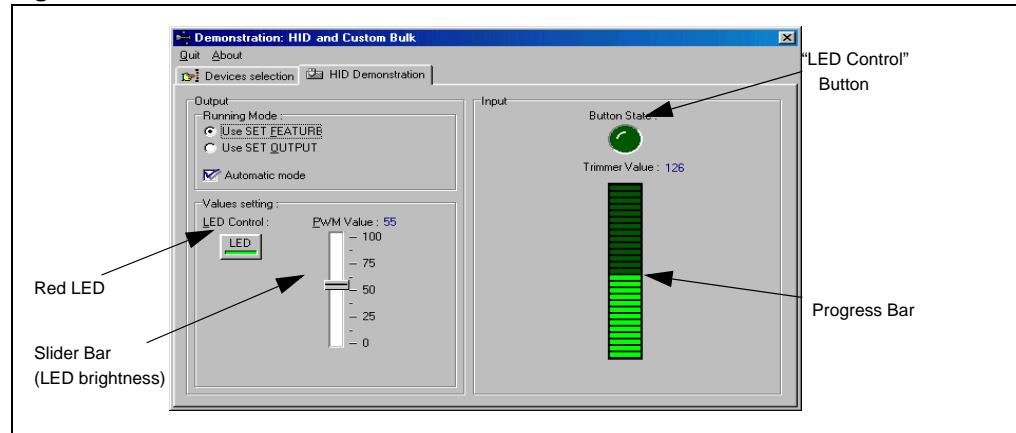

## 2.3 Remote wake-up function

The remote wake-up function is also supported by the evaluation board. By pressing SW3 (ST7262xxx) or SW2 (ST7263Bxx) you can wake up the PC from standby mode.

Under Windows XP, the remote wake-up capability should be enabled. For that you should go to the "Device Manager" then "Human Interface Device" and "HID-compliant device". On the tabsheet "Power Management", select "Allow this device to bring the computer out of standby".

## 2.4 Adding circuitry on the wire-wrap area

The evaluation board features a 43-hole row with all the microcontroller pins plus one side of the analog trimmer. These connection points can be used for signal probing or rewiring to the wire-wrap area. [Table 1](#) gives the definition of these points for each MCU used.

**Table 1. Description of evaluation board probing points**

Probing point	ST7262xxx	ST7263Bxx
1	PD6	
2	PD5	
3	PD4	
4	PD3	
5	PD2	
6	V <sub>PP</sub>	V <sub>PP</sub>
7	PD1	
8	PD0	
9	PC7	
10	PC6	
11	PC5	

**Table 1. Description of evaluation board probing points (continued)**

Probing point	ST7262xxx	ST7263Bxx
12	PC4	
13	PC3	
14	PC2	PC2
15	OSCIN	OSCIN
16	OSCOUT	OSCOUT
17	V <sub>SS</sub>	V <sub>SS</sub>
18	V <sub>DD</sub>	V <sub>DD</sub>
19	PC1	PC1
20	PC0	PC0
21	PB7	PB7
22	PB6	PB6
23	PB5	PB5
24	PB4	PB4
25	PB3	PB3
26	PB2	PB2
27	PB1	PB1
28	PB0	PB0
29	PA7	PA7
30	PA6	PA6
31	PA5	PA5
32	PA4	PA4
33	PA3	PA3
34	PA2	PA2
35	PA1	PA1
36	PA0	PA0
37	RESET	RESET
38	V <sub>SSA</sub>	
39	USBDM	USBDM
40	USBDP	USBDP
41	USBVCC	USBVCC
42	V <sub>DDA</sub>	V <sub>DDA</sub>
43	An.Trim.	An.Trim.

Figure 6. Board schematics

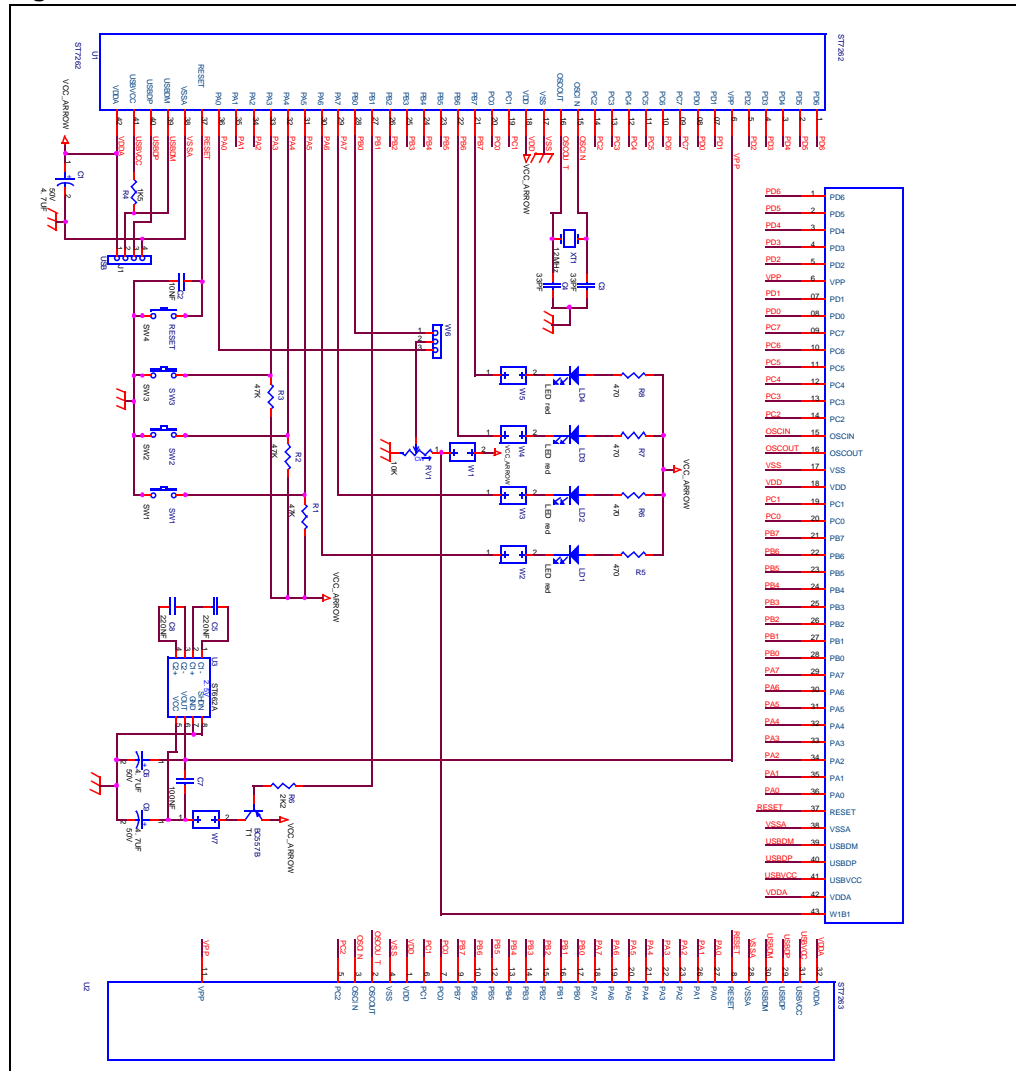

## 2.5 Enabling board for ICC communication

To enable ICC communication on this board, the connection between the  $V_{PP}$  pin of the MCU and the charge pump capacitors (C6 and C7) needs to be cut to allow the programming tool to generate pulses on the  $V_{PP}$  line (mandatory for entry into ICC mode).

To allow switching between either ICC and IAP functionality, the use of a jumper is recommended, soldered across the location of the cut. This allows 12 V to reach the  $V_{PP}$  pin in IAP mode. See the figure below for the recommended cut and jumper locations.

**Figure 7. Recommended board modifications for ICC communication**

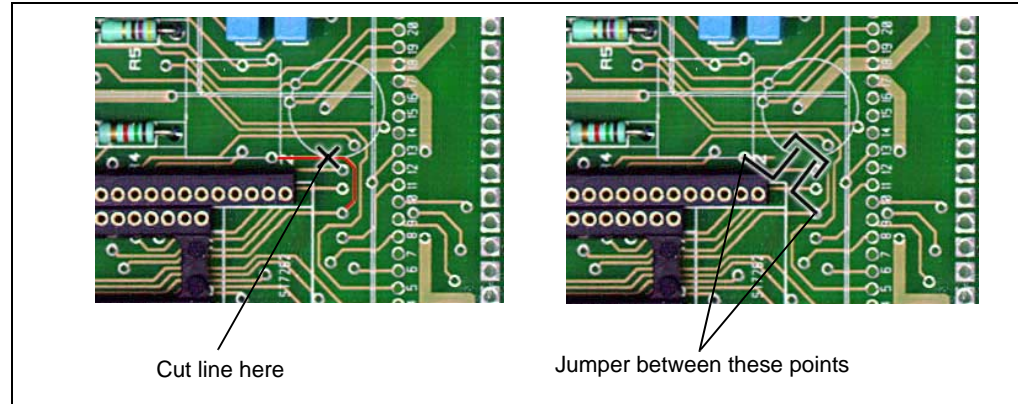

### 3 Revision history

Table 2. Document revision history

Date	Revision	Changes
28-Oct-2002	1.2	Initial Release
11-Oct-2007	2.0	Added evaluation board root part number (ST7MDTULS-EVAL). Removed ST72F61 and SDIP42-DIP20 adaptor. Changed ST72F62 and ST72F63B root part numbers into ST7262xxx and ST7263Bxx, respectively. Removed reference to supplied C source code for PC executable software, <a href="#">Section 1.2 on page 5</a> Added <a href="#">Section 2.5: Enabling board for ICC communication</a> .



**Please Read Carefully:**

Information in this document is provided solely in connection with ST products. STMicroelectronics NV and its subsidiaries ("ST") reserve the right to make changes, corrections, modifications or improvements, to this document, and the products and services described herein at any time, without notice.

All ST products are sold pursuant to ST's terms and conditions of sale.

Purchasers are solely responsible for the choice, selection and use of the ST products and services described herein, and ST assumes no liability whatsoever relating to the choice, selection or use of the ST products and services described herein.

No license, express or implied, by estoppel or otherwise, to any intellectual property rights is granted under this document. If any part of this document refers to any third party products or services it shall not be deemed a license grant by ST for the use of such third party products or services, or any intellectual property contained therein or considered as a warranty covering the use in any manner whatsoever of such third party products or services or any intellectual property contained therein.

**UNLESS OTHERWISE SET FORTH IN ST'S TERMS AND CONDITIONS OF SALE ST DISCLAIMS ANY EXPRESS OR IMPLIED WARRANTY WITH RESPECT TO THE USE AND/OR SALE OF ST PRODUCTS INCLUDING WITHOUT LIMITATION IMPLIED WARRANTIES OF MERCHANTABILITY, FITNESS FOR A PARTICULAR PURPOSE (AND THEIR EQUIVALENTS UNDER THE LAWS OF ANY JURISDICTION), OR INFRINGEMENT OF ANY PATENT, COPYRIGHT OR OTHER INTELLECTUAL PROPERTY RIGHT.**

**UNLESS EXPRESSLY APPROVED IN WRITING BY AN AUTHORIZED ST REPRESENTATIVE, ST PRODUCTS ARE NOT RECOMMENDED, AUTHORIZED OR WARRANTED FOR USE IN MILITARY, AIR CRAFT, SPACE, LIFE SAVING, OR LIFE SUSTAINING APPLICATIONS, NOR IN PRODUCTS OR SYSTEMS WHERE FAILURE OR MALFUNCTION MAY RESULT IN PERSONAL INJURY, DEATH, OR SEVERE PROPERTY OR ENVIRONMENTAL DAMAGE. ST PRODUCTS WHICH ARE NOT SPECIFIED AS "AUTOMOTIVE GRADE" MAY ONLY BE USED IN AUTOMOTIVE APPLICATIONS AT USER'S OWN RISK.**

Resale of ST products with provisions different from the statements and/or technical features set forth in this document shall immediately void any warranty granted by ST for the ST product or service described herein and shall not create or extend in any manner whatsoever, any liability of ST.

ST and the ST logo are trademarks or registered trademarks of ST in various countries.

Information in this document supersedes and replaces all information previously supplied.

The ST logo is a registered trademark of STMicroelectronics. All other names are the property of their respective owners.

© 2007 STMicroelectronics - All rights reserved

STMicroelectronics group of companies

Australia - Belgium - Brazil - Canada - China - Czech Republic - Finland - France - Germany - Hong Kong - India - Israel - Italy - Japan - Malaysia - Malta - Morocco - Singapore - Spain - Sweden - Switzerland - United Kingdom - United States of America

[www.st.com](http://www.st.com)

