

ConnectCore™ 9C Family

Interchangeable Wired/Wireless Core Modules

Highly integrated ARM9 core module family combines main processing functionality and integrated peripherals with on-board secure wireless/wired network connectivity.

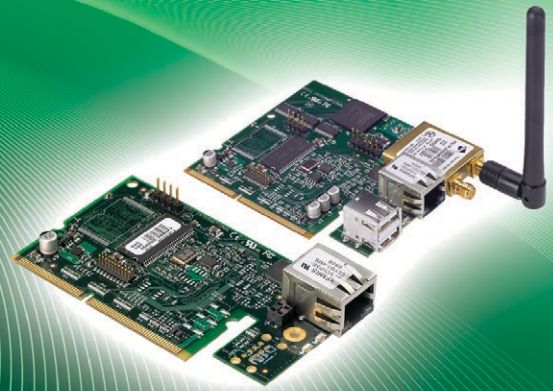

Overview

Built on leading Digi 32-bit NET+ARM technology, the ConnectCore 9C family provides a powerful network-enabled system-on-module solution. It combines main processor performance, secure wired/wireless LAN connectivity and embedded software/hardware design flexibility in a versatile and interchangeable SO-DIMM based form factor.

Utilizing Digi's own ARM processor and WLAN technology, the modules deliver a pre-certified, flexible and secure network-enabled solution for a wide variety of sophisticated applications.

The cost-effective and easy-to-use Digi JumpStart Kit® development solutions allow software design using the royalty-free and complete ThreadX-based NET+OS® platform, the feature-complete selection of high-level software components in Windows® Embedded CE, or the open Linux® environment with its strong community and readily available library of software.

Block Diagram

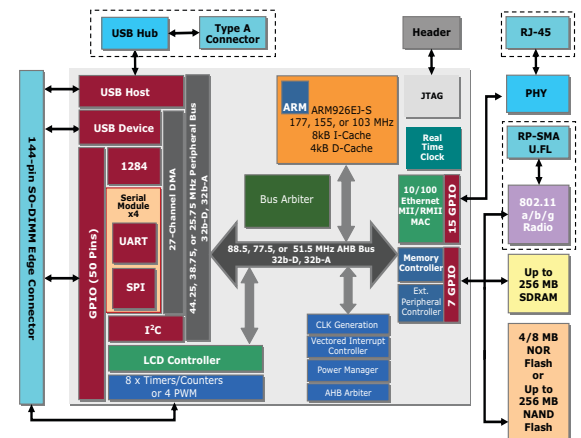

Features/Benefits

- Interchangeable 155 MHz ARM9 module in SO-DIMM form factor
- Integrated 10/100 Mbit Ethernet interface
- 802.11b/g wireless LAN with WPA2/802.11i security
- Wide range of peripheral interfaces, including USB host/device and on-chip LCD controller
- Extended operating temperature range
- Pre-certified low-emission design
- Digi processor and WLAN technology for true long-term availability
- Seamless migration path to Digi NET+ARM system-on-chip solution

Related Products



Design Services



Accessory Kits



Support

Digi
NET+OS



Windows
Embedded



Supported Software Platforms



www.digi.com

Development Kits

Digi JumpStart Kits Overview

Digi JumpStart Kit for NET+OS	Digi JumpStart Kit for Microsoft Windows Embedded CE	Digi JumpStart Kit for Embedded Linux
<p>This royalty-free turnkey solution for embedded software development is based on the ThreadX Real-Time Operating System (RTOS), one of the most reliable and field-proven RTOS solutions available. In addition to ThreadX, NET+OS provides the integrated building blocks needed to create product solutions with leading network security using Digi embedded modules and microprocessors.</p> <p>For professional NET+OS software development, the Eclipse based Digi ESP™ Integrated Development Environment (IDE) with graphical user interface and high-speed USB 2.0 hardware debugger is provided out-of-the-box.</p> <ul style="list-style-type: none"> Royalty-free turn-key solution for embedded development Built on field-proven and compact ThreadX RTOS Fully integrated support for secure, IPv4/IPv6 networking applications Professional software development using Windows-based Digi ESP IDE 	<p>Microsoft Windows Embedded CE 6.0 is a highly componentized operating system, offering pre-tested technology components designed to create sophisticated embedded applications with minimized design effort and risk. It includes a wide range of ready-to-use components such as a graphical user interface, networking, web browser and multimedia. The professional Microsoft Visual Studio 2005 development tools also support native and managed code applications using various programming languages.</p> <p>The Digi JumpStart Kit for Microsoft Windows Embedded CE 6.0 provides a complete kit with all hardware and software components needed to start immediate software development on the ConnectCore 9C/Wi-9C core module platforms. This includes support for key processor platform features such as power management modes.</p> <ul style="list-style-type: none"> Immediate Windows Embedded CE 6.0 development Seamless integration into Windows Embedded CE environment Full Digi Board Support Package (BSP) source code 180-day Visual Studio 2005 and Platform Builder trial 	<p>Built around a standard Linux 2.6 kernel distribution, the Digi JumpStart Kit for Embedded Linux is tailored to the specific needs of embedded Linux development and provides an easy-to-use, complete off-the-shelf embedded development platform. It includes all components that are required to build secure network-enabled products based on the ConnectCore 9C family.</p> <p>The kit includes Digi ESP™ for Embedded Linux, a powerful and fully Linux-hosted Integrated Development Environment based on the open Eclipse™ framework. Ideal for new and experienced Linux developers, Digi ESP improves software design productivity by accelerating and greatly simplifying driver and application development through a user-friendly graphical interface.</p> <ul style="list-style-type: none"> Complete Linux embedded Linux development platform Royalty-free and with optimized 2.6 kernel and services Linux-based Digi ESP IDE for rapid product development Full Linux and Digi Board Support Package (BSP) source 

Digi JumpStart Kit Contents

Software Platform	NET+OS	Microsoft Windows Embedded CE	Embedded Linux
Module	ConnectCore 9C or ConnectCore Wi-9C module with 4 MB NOR Flash, 16 MB SDRAM, USB Host connector, Ethernet connector, 2 x antenna connectors, 2 dBi dipole antenna (ConnectCore Wi-9C)	ConnectCore 9C or ConnectCore Wi-9C module w/ 128 MB NAND Flash, 64 MB SDRAM, USB Host connector, Ethernet connector, 2 x antenna connectors, 2 dBi dipole antenna (ConnectCore Wi-9C)	
Development Board	4 serial ports (1 x RS-232/422/485, 1 x RS-232, 2 x TTL), VGA interface, LCD/Touchscreen connector, user/application connectors, I2C/SPI headers, screw terminal for access to 8 GPIO signals, 2 user push-buttons, 2 user LEDs, 9-30VDC power supply, power switch		
CD/DVD	Digi NET+OS CD: NET+OS 7.x, Digi ESP IDE, BSP source code, sample code, support, documentation	Digi Windows CE 6.0 CD: Microsoft Windows Embedded CE 6.0 BSP w/ source code, Universal Boot Loader (U-Boot) source code, sample code, documentation Microsoft Embedded Windows CE 6.0 evaluation DVD: 180-day trial of Microsoft Embedded Windows CE 6.0, Platform Builder, Visual Studio 2005	Digi Embedded Linux 4 DVD: Digi Embedded Linux, Digi ESP IDE, Linux and platform specific source code, Universal boot loader source code (U-Boot), sample code, documentation
Documentation	Quick start guide, Digi ESP tutorial, NET+OS porting guide, NET+OS API documentation, Advanced Web Server, hardware reference manual, development board schematics	Quick start guide, Digi Windows CE 6.0 BSP user's guide, hardware reference manual, development board schematics	Quick start guide, Digi Embedded Linux user's guide, hardware reference manual, development board schematics
Power Supplies and Accessories	External wall power supply (110/240VAC to 12VDC @ 850 mA) with interchangeable outlet adapters (North America, EU, UK, and Australia), Ethernet cable, serial cable		
Other	Digi JTAG Link USB 2.0 hardware debugger	—	—
Kit Part Numbers			
Ethernet Only	CC-9C-NET	CC-9C-CE6	CC-9C-LX
WLAN + Ethernet	CC-W9C-NET	CC-W9C-CE6	CC-W9C-LX

Please refer to the feature specs on our website for detailed information about the specific software platform capabilities.

Platform	ConnectCore™ 9C	ConnectCore™ Wi-9C
Hardware		
Processor Type	32-bit NS9360 processor	
ARM Core	ARM926EJ-S	
Cache	8k I-Cache/4k D-Cache	
Processor Speed	155 MHz	
Memory Base Population	Up to 256 MB flash/SDRAM	
Additional Population Options	Flash: 4 MB / 8 MB NOR or 32-256 MB MB NAND RAM: 16-256 MB SDRAM RJ-45 Ethernet connector RP-SMA/U.FL antenna connectors 4-port USB hub component	
Pins/Form Factor	144-pin SO-DIMM	
UART	Up to 4 high-speed UARTs Maximum data rate 921 Kbps	
GPIO	Up to 55 shared GPIOs Up to 7 high-current (8 mA) pins	
SPI	Up to 4 SPI Master data rate 11.25 Mbps Slave data rate 5.5 Mbps	
I ² C	v1.0 bus interface; 7-bit and 10-bit address modes	
USB	USB 2.0 Host/Device low/full speed interface with integrated PHY (Available through optional on-module connector or edge connector)	
External Memory Bus	8-bit address and data bus with external chip select	
LCD Controller	On-chip for TFT / STN LCD panels (SVGA/18 bpp)	
PWM	Up to 4 PWM functions	
External Interrupts	4	
Timers/Counters	Up to 8 16-/32-bit timers/counters	
Dimensions (L x W x H)	3.59 in (91.19 mm) x 2.055 in (52.2 mm) x 0.712 (18.08 mm) Height and width (overhang) varies depending on connector population.	3.59 in (91.19 mm) x 3.055 in (77.6 mm) x 0.712 (18.08 mm) Height and width (overhang) varies depending on connector population.
Network Interface – Wired		
Standard	IEEE 802.3	
Physical Layer	10/100Base-T	
Data Rate	10/100 Mbps (auto-sensing)	
Mode	Full or half duplex (auto-sensing)	
Connector	On-module RJ-45 with magnetics (optional)	
Power-over-Ethernet	802.3af compliant power pass-through (Model with integrated RJ-45 only)	
Network Interface – Wireless LAN		
Standard	—	IEEE 802.11b/g
Security	—	WEP/WPA/WPA2/802.11i
Frequency	—	2.4 GHz
Data Rate	—	Up to 54 Mbps with fallback
Modulation	—	DBPSK (1 Mbps), DQPSK (2 Mbps), CCK (11,5.5 Mbps), BPSK (6,9 Mbps), PSK (12,18 Mbps), 16-QAM (24,36 Mbps), 64-QAM (48, 54 Mbps)
Transmit Power	—	16 dBm typical
Receive Sensitivity	—	-73 dBm at 54 Mbps
Power Requirements		
Maximum	750 mA @ 3.3VDC	900 mA @ 3.3VDC
USB Host	5VDC ± 10% @ 1A max. (optional)	

Platform	ConnectCore™ 9C	ConnectCore™ Wi-9C
-----------------	------------------------	---------------------------

Environmental		
Operating Temperature	-40° C to +85° C (-40° F to 185° F)	-30° C to 75° C (-22° F to 167° F)
Storage Temperature	-50° C to 125° C (-58° F to 257° F)	
Relative Humidity	5% to 95% (non-condensing)	
Altitude	12,000 feet (3,658 meters)	

Regulatory Approvals		
FCC Part 15 Class B, EN 55022 Class B		•
EN 61000-3-2 and EN 61000-3-3		•
ICES-003 Class B, VCCI Class II, AS 3548		•
FCC Part 15 Sub C Section 15.247		•
IC RSS-210 Issue 5 Section 6.2.2(o)		•
EN 300 328, EN 301 489-17		•
UL 60950-1, EN 60950 (EU)		•
CSA C22.2, No. 60950		•
EN 55024		•

Module Feature

ConnectCore 9C/Wi-9C Top View

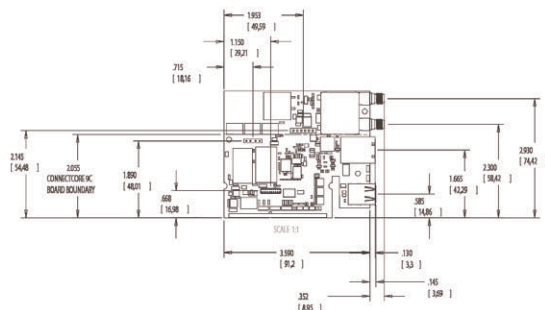

ConnectCore 9C Side View

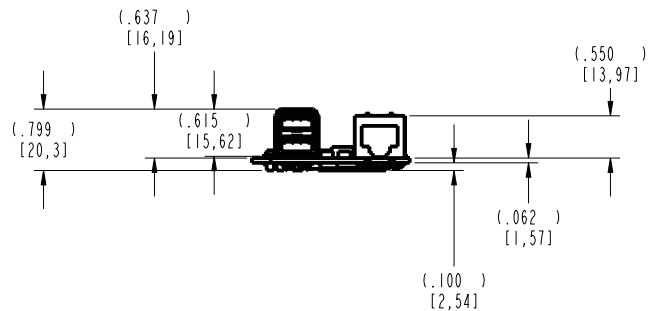

ConnectCore Wi-9C Side View

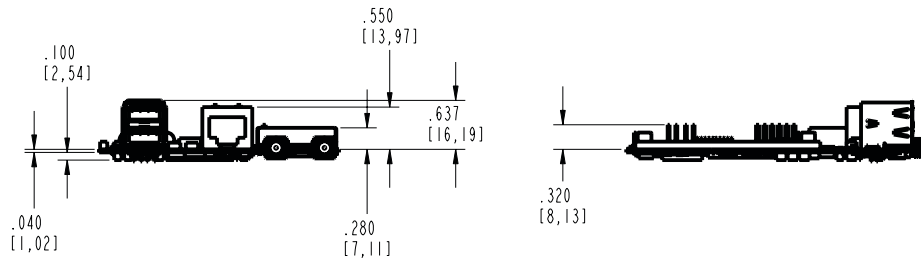

Visit www.digiembedded.com for part numbers.

DIGI SERVICE AND SUPPORT - You can purchase with confidence knowing that Digi is here to support you with expert technical support and a strong five-year warranty. www.digi.com/support

Digi International
877-912-3444
952-912-3444
info@digi.com

Digi International France
+33-1-55-61-98-98
www.digi.fr

Digi International KK
+81-3-5428-0261
www.digi-intl.co.jp

Digi International (HK) Limited
+852-2833-1008
www.digi.cn

BUY ONLINE • www.digiembedded.com



91001407
D1/309

© 2005-2009 Digi International Inc. All rights reserved. Digi, Digi International, the Digi logo, the When Reliability Matters logo, ConnectCore, Digi ESP, Digi JumpStart Kit, NET+ and NET+OS are trademarks or registered trademarks of Digi International Inc. in the United States and other countries worldwide. ARM and NET+ARM are trademarks or registered trademarks of ARM Limited. All other trademarks are the property of their respective owners.

