

**PART NUMBER:** VAWQ12

**DESCRIPTION:** dc-dc converter

**description**

Designed to convert a wide input voltage range into an isolated regulated voltage, the VAWQ12 series is well suited for data transfer equipment, battery operated equipment, distributed power systems, mix analog/digital systems, remote control systems, industrial robot systems, etc...

**features**

- efficiency up to 88%
- wide (4:1) input range
- 12 W rated power output
- I/O isolation: 1500 V dc
- DIP24 package
- industry standard pinout
- five-sided metal shielding package
- temperature range: -40°C~+85°C
- over voltage protection
- short circuit protection
- remote ON/OFF

**MODEL**

MODEL	nominal (V dc)	input voltage range (V dc)	max. (V dc)	no load typ. (mA)	output voltage (V dc)	output current max. (mA)	min. (mA)	efficiency typ. (%)
VAWQ12-Q24-S3R3	24	9.0~36.0	40	55	3.3	3500	0	85
VAWQ12-Q24-S5	24	9.0~36.0	40	55	5	2400	0	86
VAWQ12-Q24-S12	24	9.0~36.0	40	25	12	1000	0	86
VAWQ12-Q24-S15	24	9.0~36.0	40	25	15	800	0	86
VAWQ12-Q48-S3R3	48	18.0~75.0	80	20	3.3	3500	0	85
VAWQ12-Q48-S5	48	18.0~75.0	80	20	5	2400	0	87
VAWQ12-Q48-S12	48	18.0~75.0	80	10	12	1000	0	87
VAWQ12-Q48-S15	48	18.0~75.0	80	10	15	800	0	88

**INPUT**

parameter	conditions/description	min	nom	max	units
input voltage range	9~36 V dc		24	40	V dc
	18~75 V dc		48	80	V dc
start-up time	input voltage range, refer to output load		500		ms
under voltage protection	nominal input 24 V, dc-dc module ON		8.8	9	V dc
	nominal input 24 V, dc-dc module OFF		8.3	8.5	V dc
	nominal input 48 V, dc-dc module ON		17	17.5	V dc
	nominal input 48 V, dc-dc module OFF		16.5	17	V dc
CTRL	dc-dc module ON (or open circuit)	3		40	V dc
	dc-dc module OFF	0		1.2	V dc

**OUTPUT**

parameter	conditions/description	min	nom	max	units
output power	25°C ambient temperature			12	W
voltage accuracy	refer to recommended circuit		±1	±3	%
ripple & noise	@ 20MHz Bandwidth			85	mVpp
line regulation	input voltage from low to high		±0.2	±0.5	%
load regulation	10% to 100% full load		±0.5	±1.5	%
temperature coefficient	refer to recommended circuit		0.02		%/°C
switching frequency	10~100% load, nominal input	350	400	450	KHz
over voltage protection	3.3 V output		4.3		V dc
	5 V output		6		V dc
	12 V output		13		V dc
	15 V output		16		V dc
short circuit protection	continuous, automatic recovery				

**PART NUMBER:** VAWQ12

**DESCRIPTION:** dc-dc converter

### GENERAL SPECIFICATIONS

parameter	conditions/description	
temperature rise at full load	95°C typ., 105°C max.	
cooling	free air convection	
operating temp. range	-40°C ~ +85°C	(power derating at 55°C, refer to temperature derating graph)
storage temp. range	-55°C ~ +125°C	
reflow soldering temp.	300°C	(for 10 seconds, 1.5 mm from case)
storage humidity range	≤95%	
case material	copper plated nickel	
weight	18.5 g (typ.)	
MTBF	>1,000,000 hours	MIL-HDBK-217F (25°C)

### ISOLATION SPECIFICATIONS

parameter	conditions/description	min	nom	max	units
isolation voltage	input/output, flash tested for 1 min.	1500			V dc
	input/output/case, flash tested for 1 min.	1500			V dc
isolation resistance	tested at 500 V dc	1000			MΩ
	tested at 500 V dc	1000			MΩ
isolation capacitance				1100	pF

- notes:
1. All specifications measured at  $T_A=25^\circ\text{C}$ , humidity <75%, nominal input voltage and rated output load unless otherwise specified.
  2. When the product begins to work, the temperature may rise slowly until stable. It is normal that output voltage derating and efficiency reduce about 2% during this process.
  3. The CTRL pin voltage is referenced to GND.

**PART NUMBER:** VAWQ12

**DESCRIPTION:** dc-dc converter

**Application Notes:**

- All of the VAWQ12 Series have been tested according to the following recommended testing circuit before leaving the factory. This series should be tested under load (Figure 1). If you want to further decrease the input ripple, you can use a 100  $\mu\text{F}$  capacitor at Cin. If output filtering is required, you can add a capacitor to the output. However, the capacitance should not be higher than maximum capacitance.

- Temperature Derating Curve

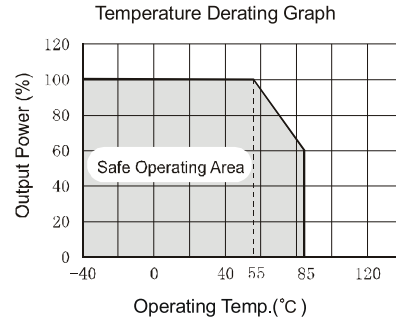

**Figure 1**

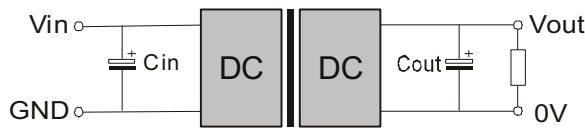

- Efficiency Curves

**Output Capacitor Values**

output voltage	recommended capacitance ( $\mu\text{F}$ )	maximum capacitance ( $\mu\text{F}$ )
3.3	220	3000
5	220	2000
12	100	500
15	100	400

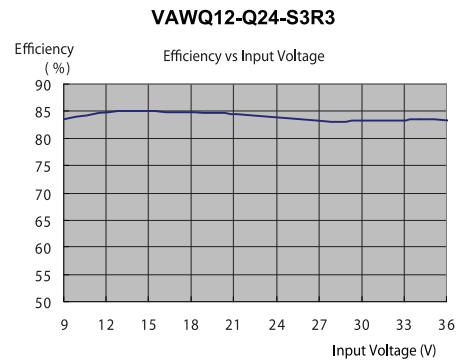
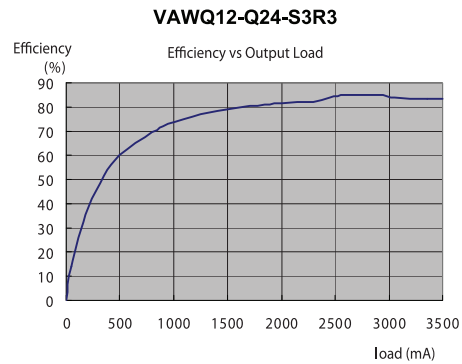

REV.	DESCRIPTION	DATE
A	NEW DRAWING	12/30/2008

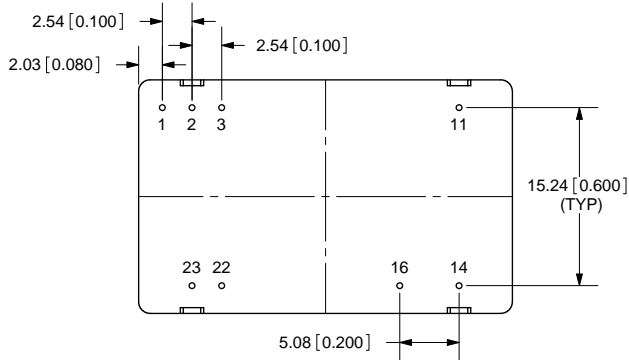
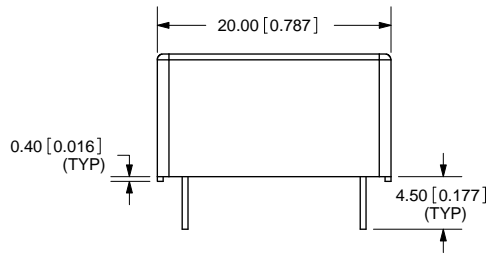
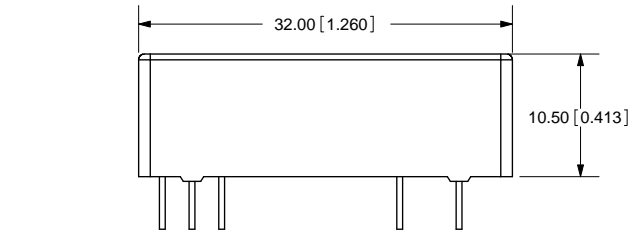

FOOTPRINT DETAILS

Pin	Function
1	CTRL
2,3	GND
11	NC
14	+Vo
16	0V
22,23	Vin

NC: No Connection

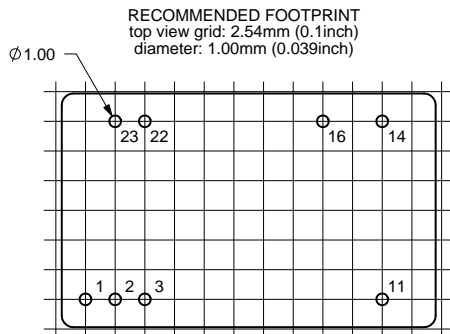

TOLERANCE:  
Pin section: 0.50mm (0.020inch)  
Pin section tolerances:  $\pm 0.05\text{mm}$  ( $\pm 0.002\text{inch}$ )  
General tolerances:  $\pm 0.25\text{mm}$  ( $\pm 0.010\text{inch}$ )



20050 SW 112th Ave.  
Tualatin, OR 97062  
Phone: 503-612-2332  
866-372-1258  
Fax: 503-612-2382  
Website: www.v-infinity.com

TITLE: DC-DC CONVERTER		REV: A
PART NO. VAWQ12	UNITS: MM [INCHES]	
DRAWN BY: JMS	APPROVED BY:	SCALE: 2:1

PC FILE NAME: VAWQ12

COPYRIGHT 2008 BY CUI INC.