

EVAL-ADXRS610

GENERAL DESCRIPTION

The EVAL-ADXRS610 is a simple evaluation board that allows quick evaluation of the performance of the ADXRS610 $\pm 300^\circ/\text{sec}$ yaw rate gyro. No additional external components are required for operation. The EVAL-ADXRS610 has a 20-lead, dual in-line (0.3-inch width \times 0.1-inch pin spacing) interface that allows easy prototyping of products without BGA soldering.

CIRCUIT DESCRIPTION

The schematic of the EVAL-ADXRS610 is shown in Figure 1. The numbers that appear in squares correspond to the pins on the evaluation board. It is identical to the suggested application shown in the ADXRS610 data sheet.

The analog and power grounds (AGND and PGND) have separate power planes in this evaluation board to accommodate application-specific grounding schemes. If the user requires only a single ground plane, these nodes can be shorted together. Both AGND and PGND must be grounded for the evaluation board to operate properly.

Note that the analog supply voltage and charge pump supply voltage (AV_{CC} and V_{DD}) are not connected on the EVAL-ADXRS610 and that users may connect these as appropriate to their application.

The parts layout of the EVAL-ADXRS610 is shown in Figure 2 and the parts list for the EVAL-ADXRS610 is shown in Table 1. As delivered, the EVAL-ADXRS610 is set to 10 Hz bandwidth ($C_{OUT} = 100 \text{ nF}$). The user may add an external capacitor to further reduce the bandwidth and improve the noise floor.

SPECIAL NOTES ON HANDLING

Note that the EVAL-ADXRS610 is not reverse polarity protected. Reversing the power supply or applying inappropriate voltages to any pin (outside the Absolute Maximum Ratings listed in the ADXRS610 data sheet) may damage the EVAL-ADXRS610.

SCHEMATICS AND PARTS LIST/LAYOUT

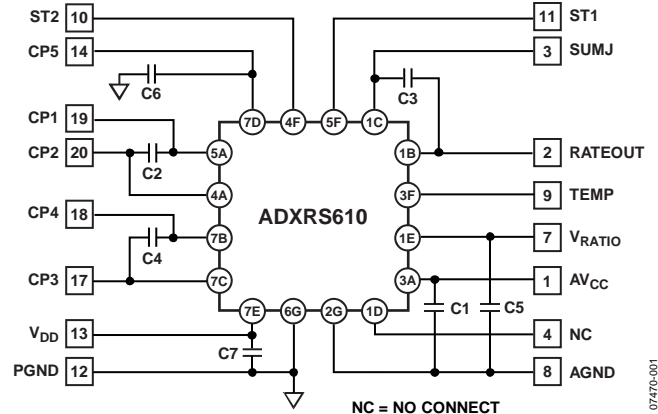

Figure 1. EVAL-ADXRS610 Schematic

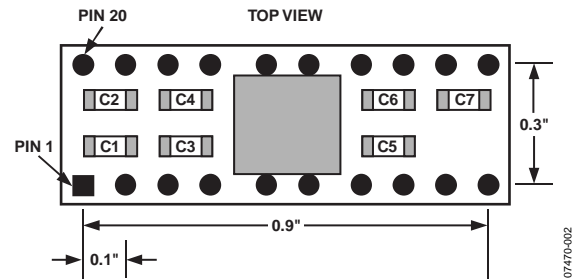

Figure 2. EVAL-ADXRS610 Parts Layout

Table 1. EVAL-ADXRS610 Parts List

Component	Value (nF)
C1	100
C2	22
C3	100
C4	22
C5	100
C6	100
C7	100

Rev. A

Evaluation boards are only intended for device evaluation and not for production purposes. Evaluation boards are supplied "as is" and without warranties of any kind, express, implied, or statutory including, but not limited to, any implied warranty of merchantability or fitness for a particular purpose. No license is granted by implication or otherwise under any patents or other intellectual property by application or use of evaluation boards. Information furnished by Analog Devices is believed to be accurate and reliable. However, no responsibility is assumed by Analog Devices for its use, nor for any infringements of patents or other rights of third parties that may result from its use. Analog Devices reserves the right to change devices or specifications at any time without notice. Trademarks and registered trademarks are the property of their respective owners. Evaluation boards are not authorized to be used in life support devices or systems.

EVAL-ADXRS610

REVISION HISTORY

1/10—Rev. 0 to Rev. A
Changes to Circuit Description 1
6/08—Revision 0: Initial Version

ORDERING GUIDE

Model ¹	Package Description
EVAL-ADXRS610Z	Evaluation Board

¹ Z = RoHS Compliant Part.

ESD CAUTION



ESD (electrostatic discharge) sensitive device. Charged devices and circuit boards can discharge without detection. Although this product features patented or proprietary protection circuitry, damage may occur on devices subjected to high energy ESD. Therefore, proper ESD precautions should be taken to avoid performance degradation or loss of functionality.