

FEATURES

- Dual axis accelerometer on a single IC chip
- 5 mm \times 5 mm \times 2 mm LCC package
- 1 mg resolution at 60 Hz
- Low power: 700 μ A at $V_s = 5$ V (typical)
- High zero g bias stability
- High sensitivity accuracy
- Pulse width modulated digital outputs
- X and Y axes aligned to within 0.1° (typical)
- BW adjustment with a single capacitor
- Single-supply operation
- 3500 g shock survival
- Qualified for automotive applications

APPLICATIONS

- Automotive tilt alarms
- Data projectors
- Navigation
- Platform stabilization/leveling
- Alarms and motion detectors
- High accuracy, 2-axis tilt sensing

GENERAL DESCRIPTION

The ADXL213 is a low cost, low power, complete dual axis accelerometer with signal conditioned, duty cycle modulated outputs, all on a single monolithic IC. The ADXL213 measures acceleration with a full-scale range of $\pm 1.2 g$ (typical). The ADXL213 can measure both dynamic acceleration (e.g., vibration) and static acceleration (e.g., gravity).

The outputs are digital signals whose duty cycles (ratio of pulse width to period) are proportional to acceleration ($30\%/g$). The duty cycle outputs can be directly measured by a microcontroller without an A/D converter or glue logic.

Innovative design techniques are used to ensure high zero g bias stability (typically better than $0.25 \text{ mg}/^\circ\text{C}$), as well as tight sensitivity stability (typically better than $50 \text{ ppm}/^\circ\text{C}$).

The typical noise floor is $160 \mu\text{g}/\sqrt{\text{Hz}}$, allowing signals below 1 mg (0.06° of inclination) to be resolved in tilt sensing applications using narrow bandwidths (< 60 Hz).

The user selects the bandwidth of the accelerometer using capacitors C_X and C_Y at the X_{FILT} and Y_{FILT} pins. Bandwidths of 0.5 Hz to 250 Hz may be selected to suit the application.

The ADXL213 is available in a 5 mm \times 5 mm \times 2 mm, 8-pad hermetic LCC package.

FUNCTIONAL BLOCK DIAGRAM

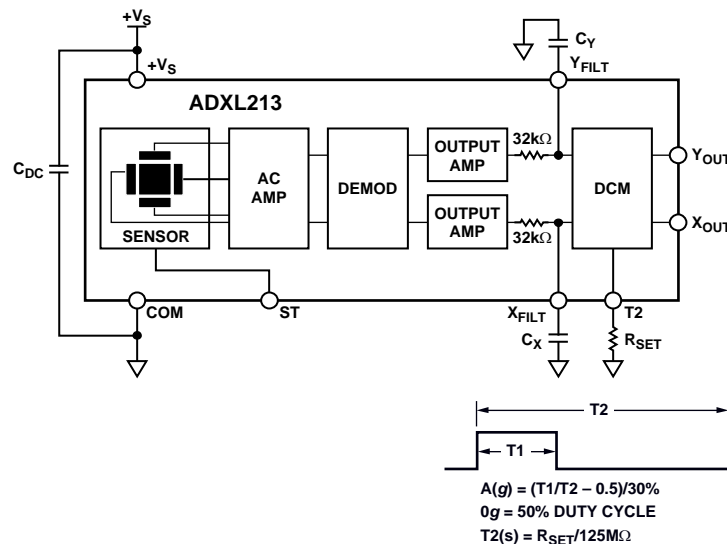

Figure 1.

Rev. A

Information furnished by Analog Devices is believed to be accurate and reliable. However, no responsibility is assumed by Analog Devices for its use, nor for any infringements of patents or other rights of third parties that may result from its use. Specifications subject to change without notice. No license is granted by implication or otherwise under any patent or patent rights of Analog Devices. Trademarks and registered trademarks are the property of their respective owners.

One Technology Way, P.O. Box 9106, Norwood, MA 02062-9106, U.S.A.
 Tel: 781.329.4700 www.analog.com
 Fax: 781.326.8703 © 2004–2010 Analog Devices, Inc. All rights reserved.

TABLE OF CONTENTS

| | | | |
|---------------------------------------------------|---|-------------------------------------------------------------------------------------|----|
| Revision History | 2 | Design Trade-Offs for Selecting Filter Characteristics: The Noise/BW Trade-Off..... | 9 |
| Specifications..... | 3 | Using the ADXL213 with Operating Voltages Other than 5 V .. | 10 |
| Absolute Maximum Ratings..... | 4 | Using the ADXL213 as a Dual-Axis Tilt Sensor..... | 10 |
| Typical Performance Characteristics | 5 | Pin Configurations and Functional Descriptions | 11 |
| Theory of Operation | 8 | Outline Dimensions | 12 |
| Performance | 8 | ESD Caution..... | 12 |
| Applications..... | 9 | Ordering Guide..... | 12 |
| Power Supply Decoupling..... | 9 | Automotive Products..... | 12 |
| Setting the Bandwidth Using C_x and C_y | 9 | | |
| Self Test..... | 9 | | |

REVISION HISTORY

8/10—Rev. 0 to Rev. A

| | |
|-------------------------------------------------|----|
| Added Automotive line to Features Section | 1 |
| Updated Outline Dimensions | 12 |
| Changes to Ordering Guide | 12 |
| Added Automotive Products Section | 12 |

4/04—Revision 0: Initial Version

SPECIFICATIONS

$T_A = -40^\circ\text{C}$ to $+85^\circ\text{C}$, $V_S = 5\text{ V}$, $C_X = C_Y = 0.1\ \mu\text{F}$, Acceleration = 0 g , unless otherwise noted. All minimum and maximum specifications are guaranteed. Typical specifications are not guaranteed.

Table 1.

| Parameter | Conditions | Min | Typ | Max | Unit |
|----------------------------------------------------|-----------------------------------------|-------|------------|-----|------------------------------------|
| SENSOR INPUT | | | | | |
| Measurement Range ¹ | Each axis | | ± 1.2 | | <i>g</i> |
| Nonlinearity | % of full scale | | ± 0.5 | | % |
| Package Alignment Error | | | ± 1 | | Degrees |
| Alignment Error | X sensor to Y sensor | | ± 0.1 | | Degrees |
| Cross Axis Sensitivity | | | ± 2 | | % |
| SENSITIVITY (Ratiometric)² | | | | | |
| Sensitivity at X_{OUT} , Y_{OUT} | $V_S = 5\text{ V}$ | 27 | 30 | 33 | %/g |
| Sensitivity Change due to Temperature ³ | $V_S = 5\text{ V}$ | | ± 0.3 | | % |
| ZERO g BIAS LEVEL (Ratiometric) | | | | | |
| 0 g Voltage at X_{OUT} , Y_{OUT} | $V_S = 5\text{ V}$ | | ± 50 | | % |
| Initial 0 g Output Deviation from Ideal | $V_S = 5\text{ V}$, 25°C | | ± 2 | | % |
| 0 g Offset vs. Temperature | | | ± 0.25 | | mg/ $^\circ\text{C}$ |
| NOISE PERFORMANCE | | | | | |
| Noise Density | @ 25°C | | 160 | | $\mu\text{g}/\sqrt{\text{Hz}}$ rms |
| FREQUENCY RESPONSE⁴ | | | | | |
| C_X , C_Y Range ⁵ | | 0.002 | | 4.7 | μF |
| R_{FILT} Tolerance | | 22 | 32 | 42 | k Ω |
| Sensor Resonant Frequency | | | 5.5 | | kHz |
| SELF TEST⁶ | | | | | |
| Logic Input Low | | | | 1 | V |
| Logic Input High | | 4 | | | V |
| ST Input Resistance to Ground | | 30 | 50 | | k Ω |
| Output Change at X_{OUT} , Y_{OUT} | Self test 0 to 1 | | 23 | | % |
| PWM Output | | | | | |
| F_{SET} | $R_{\text{SET}} = 125\text{ k}\Omega$ | | 1 | | kHz |
| T2 Drift versus Temperature | | | ± 0.3 | | % |
| POWER SUPPLY | | | | | |
| Operating Voltage Range | | 3 | | 6 | V |
| Quiescent Supply Current | | | 0.7 | 1.1 | mA |
| Turn-On Time ⁷ | | | 20 | | ms |

¹ Guaranteed by measurement of initial offset and sensitivity.

² Sensitivity varies with V_S . At $V_S = 3\text{ V}$, sensitivity is typically 28%/g.

³ Defined as the output change from ambient-to-maximum temperature or ambient-to-minimum temperature.

⁴ Actual frequency response controlled by user-supplied external capacitor (C_X , C_Y).

⁵ Bandwidth = $1/(2 \times \pi \times 32\text{ k}\Omega \times C)$. For C_X , $C_Y = 0.002\ \mu\text{F}$, Bandwidth = 2500 Hz. For C_X , $C_Y = 4.7\ \mu\text{F}$, Bandwidth = 1 Hz. Minimum/maximum values are not tested.

⁶ Self-test response changes with V_S . At $V_S = 3\text{ V}$, self-test output is typically 8%.

⁷ Larger values of C_X , C_Y increase turn-on time. Turn-on time is approximately $160 \times C_X$ or $C_Y + 4\text{ ms}$, where C_X , C_Y are in μF .

ABSOLUTE MAXIMUM RATINGS

Table 2. ADXL213 Stress Ratings

| Parameter | Rating |
|---------------------------------------------------|-------------------------------------------|
| Acceleration (Any Axis, Unpowered) | 3,500 g |
| Acceleration (Any Axis, Powered) | 3,500 g |
| Drop Test (Concrete Surface) | 1.2 m |
| V _s | -0.3 V to +7.0 V |
| All Other Pins | (COM - 0.3 V) to (V _s + 0.3 V) |
| Output Short-Circuit Duration (Any Pin to Common) | Indefinite |
| Operating Temperature Range | -55°C to +125°C |
| Storage Temperature | -65°C to +150°C |

Table 3. Package Characteristics

| Package Type | θ _{JA} | θ _{JC} | Device Weight |
|--------------|-----------------|-----------------|---------------|
| 8-Lead CLCC | 120°C/W | 20°C/W | <1.0 gram |

Stresses above those listed under Absolute Maximum Ratings may cause permanent damage to the device. This is a stress rating only; functional operation of the device at these or any other conditions above those indicated in the operational section of this specification is not implied. Exposure to absolute maximum rating conditions for extended periods may affect device reliability.

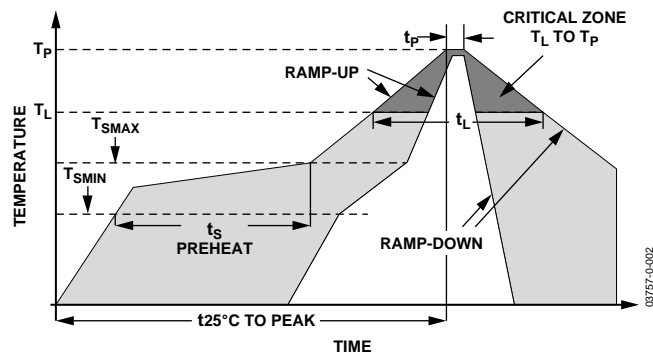

| Profile Feature | Condition | |
|--------------------------------------------------------------------|-----------------|-----------------|
| | Sn63/Pb37 | Pb Free |
| Average Ramp Rate (T _L to T _P) | 3°C/second max | |
| Preheat | | |
| • Minimum Temperature (T _{SMIN}) | 100°C | 150°C |
| • Minimum Temperature (T _{SMAX}) | 150°C | 200°C |
| • Time (T _{SMIN} to T _{SMAX}) (t _s) | 60–120 seconds | 60–150 seconds |
| T _{SMAX} to T _L | | |
| • Ramp-Up Rate | 3°C/second | |
| Time Maintained above Liquidous (T _L) | | |
| • Liquidous Temperature (T _L) | 183°C | 217°C |
| • Time (t _L) | 60–150 seconds | 60–150 seconds |
| Peak Temperature (T _P) | 240°C +0°C/-5°C | 260°C +0°C/-5°C |
| Time within 5°C of Actual Peak Temperature (t _p) | 10–30 seconds | 20–40 seconds |
| Ramp-Down Rate | 6°C/second max | |
| Time 25°C to Peak Temperature | 6 minutes max | 8 minutes max |

Figure 2. Recommended Soldering Profile

TYPICAL PERFORMANCE CHARACTERISTICS

($V_s = 5\text{ V}$ for all graphs, unless otherwise noted.)

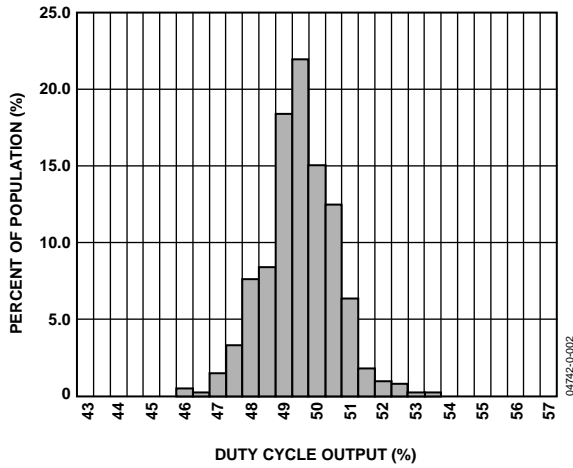

Figure 3. X Axis Zero g Bias Deviation from Ideal at 25°C

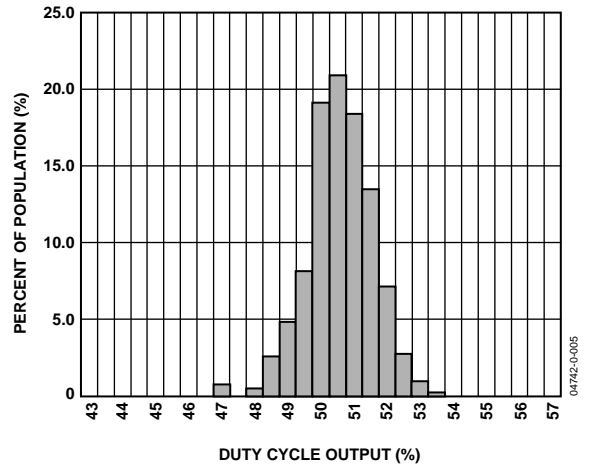

Figure 6. Y Axis Zero g Bias Deviation from Ideal at 25°C

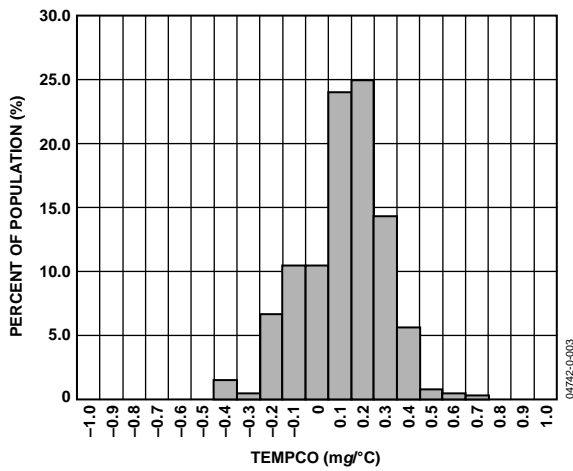

Figure 4. X Axis Zero g Bias Tempco

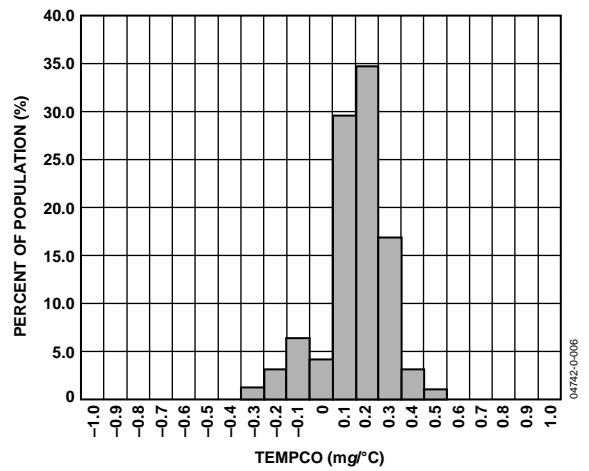

Figure 7. Y Axis Zero g Bias Tempco

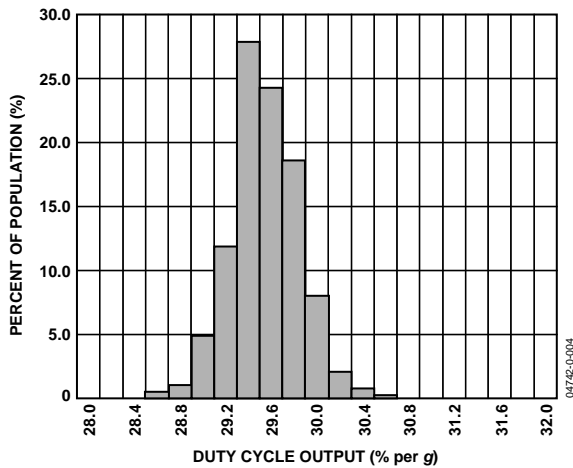

Figure 5. X Axis Sensitivity at 25°C

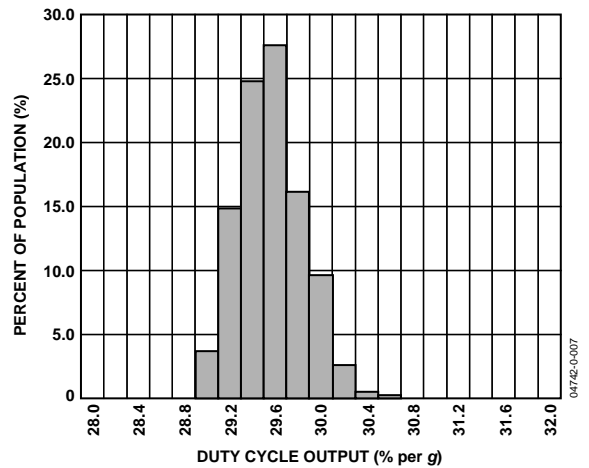

Figure 8. Y Axis Sensitivity at 25°C

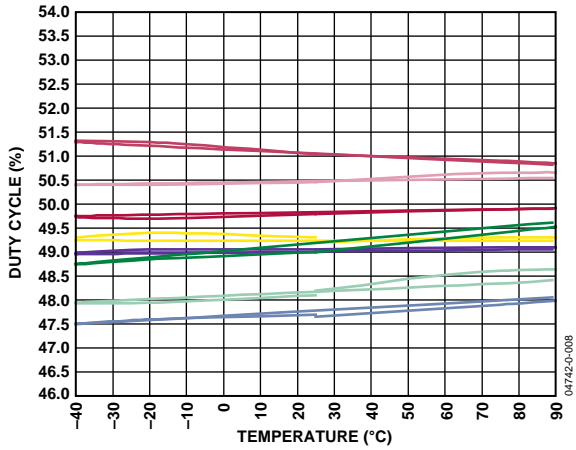

Figure 9. Zero g Bias vs. Temperature – Parts Soldered to PCB

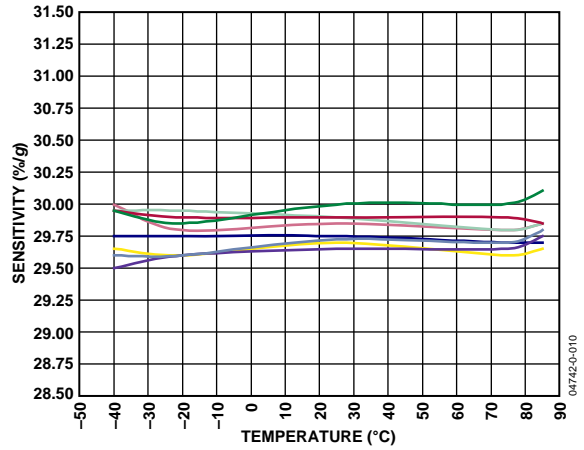

Figure 12. Sensitivity vs. Temperature – Parts Soldered to PCB

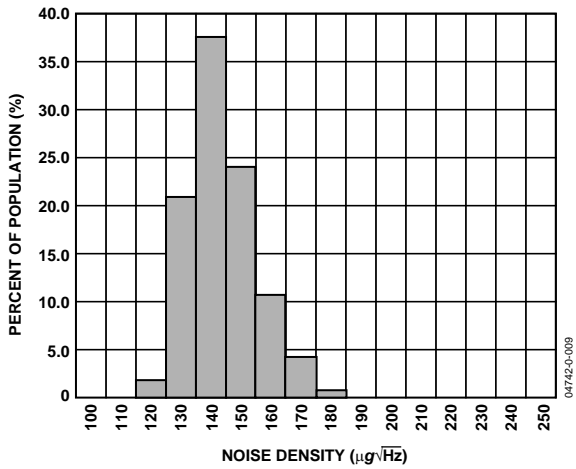

Figure 10. X Axis Noise Density at 25°C

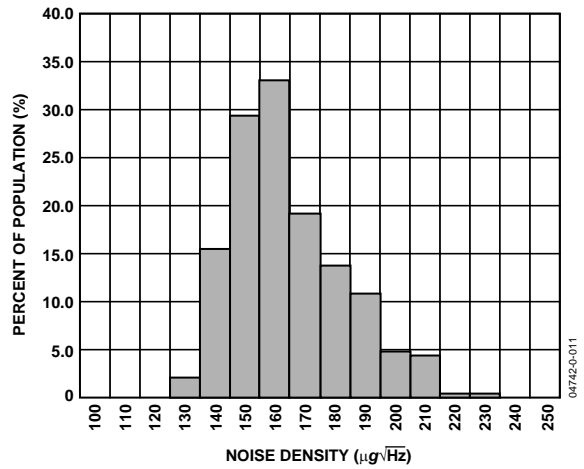

Figure 13. Y Axis Noise Density at 25°C

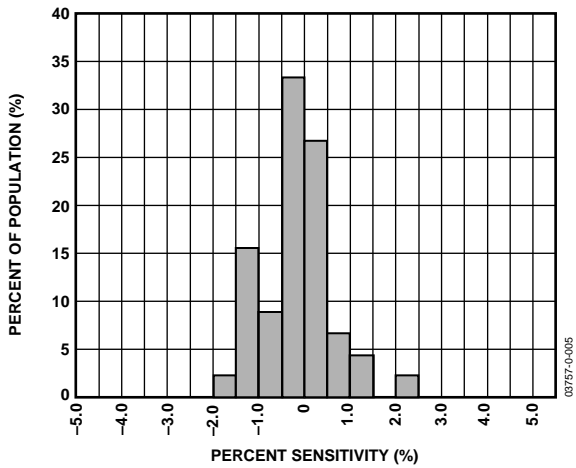

Figure 11. Z vs. X Cross-Axis Sensitivity

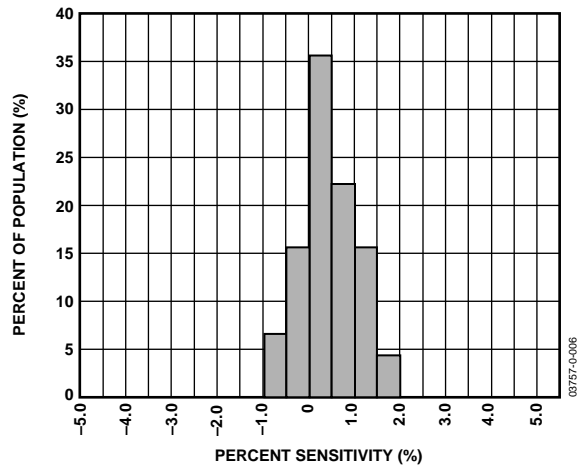

Figure 14. Z vs. Y Cross-Axis Sensitivity

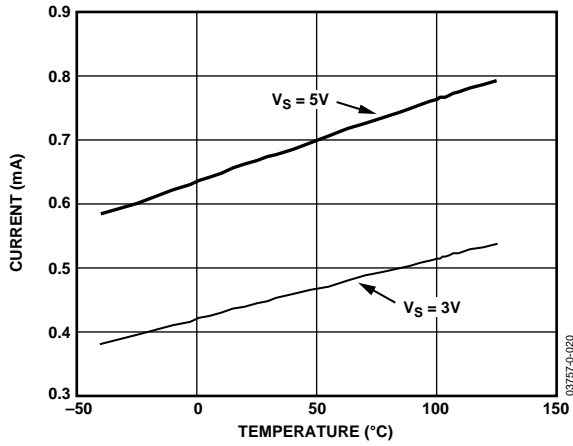

Figure 15. Supply Current vs. Temperature

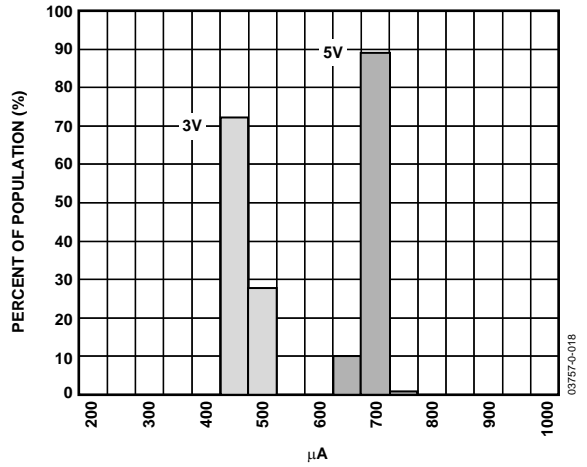

Figure 18. Supply Current at 25°C

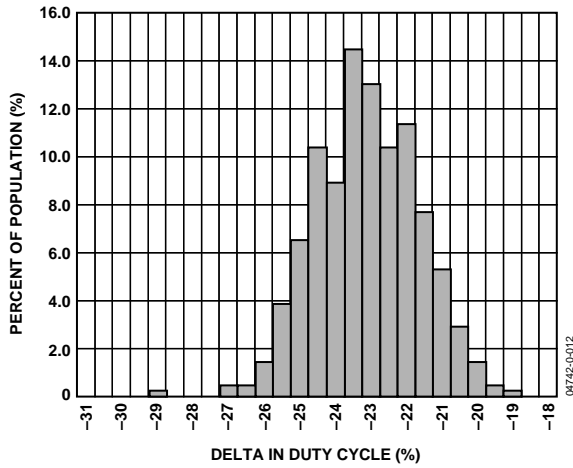

Figure 16. X Axis Self Test Response at 25°C

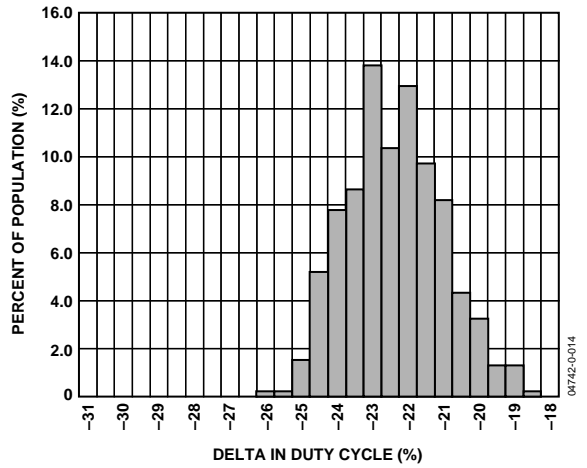

Figure 19. Y Axis Self Test Response at 25°C

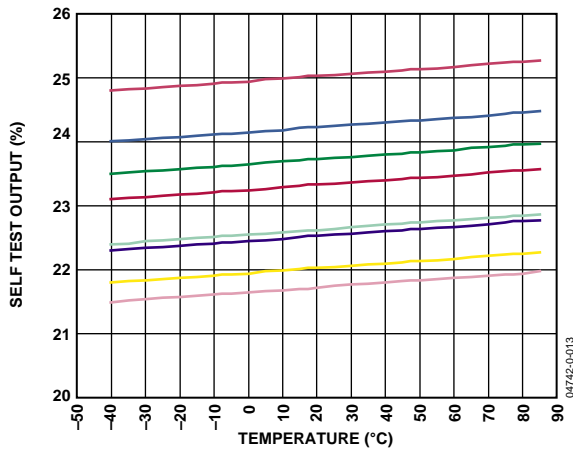

Figure 17. Self Test Response vs. Temperature

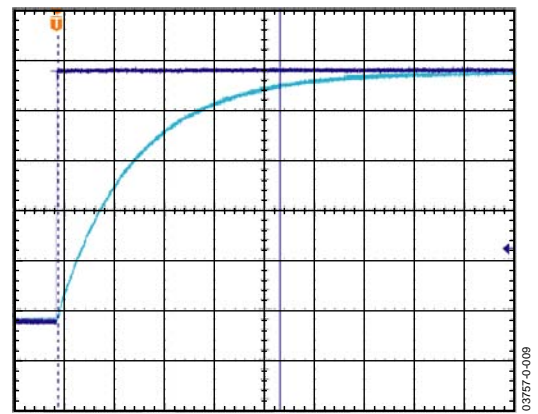

Figure 20. Turn-On Time – C_X, C_Y = 0.1 µF, Time Scale = 2 ms/div

THEORY OF OPERATION

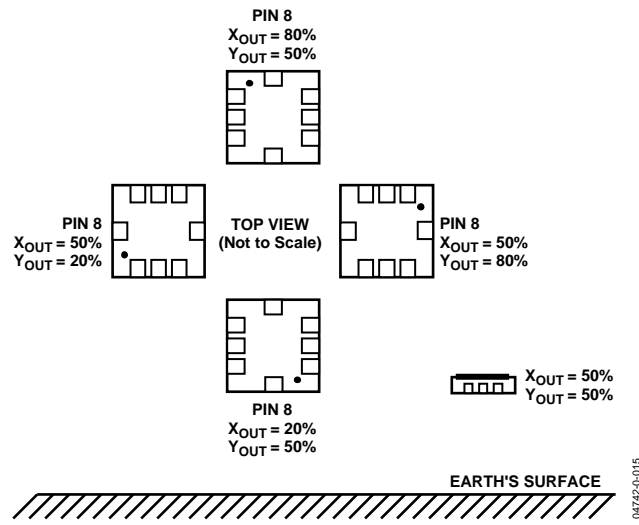

Figure 21. Output Response vs. Orientation

The ADXL213 is a complete dual axis acceleration measurement system on a single monolithic IC. It contains a polysilicon surface-micromachined sensor and signal conditioning circuitry to implement an open-loop acceleration measurement architecture. The output signals are duty cycle modulated digital signals proportional to acceleration. The ADXL213 is capable of measuring both positive and negative accelerations to $\pm 1.2g$. The accelerometer can measure static acceleration forces such as gravity, allowing the ADXL213 to be used as a tilt sensor.

The sensor is a surface-micromachined polysilicon structure built on top of the silicon wafer. Polysilicon springs suspend the structure over the surface of the wafer and provide a resistance against acceleration forces. Deflection of the structure is measured using a differential capacitor that consists of independent fixed plates and plates attached to the moving mass. The fixed plates are driven by 180° out-of-phase square waves. Acceleration deflects the beam and unbalances the differential capacitor, resulting in an output square wave whose amplitude is proportional to acceleration. Phase sensitive demodulation techniques are then used to rectify the signal and determine the direction of the acceleration.

The output of the demodulator is amplified and brought off-chip through a 32 k Ω resistor. At this point, the user can set the signal bandwidth of the device by adding a capacitor. This filtering improves measurement resolution and helps prevent aliasing.

After being low-pass filtered, the duty cycle modulator converts the analog signals to duty cycle modulated outputs that can be read by a counter. A single resistor (R_{SET}) sets the period for a complete cycle. A 0 g acceleration produces a 50% nominal duty cycle. The acceleration can be determined by measuring the length of the positive pulse width (t_1) and the period (t_2). The nominal transfer function of the ADXL213 is

$$Acceleration = ((t_1/t_2) - Zero\ g\ Bias) / Sensitivity$$

Where in the case of the ADXL213

$$Zero\ g\ Bias = 50\% \text{ nominal}$$

$$Sensitivity = 30\%/g \text{ nominal}$$

$$t_2 = R_{SET} / 125\ M\Omega$$

PERFORMANCE

Rather than using additional temperature compensation circuitry, innovative design techniques have been used to ensure that high performance is built in. As a result, there is essentially no quantization error or nonmonotonic behavior, and temperature hysteresis is very low (typically less than 10 mg over the -40°C to $+85^\circ\text{C}$ temperature range).

Figure 9 shows the zero g output performance of eight parts (X and Y axis) over a -40°C to $+85^\circ\text{C}$ temperature range.

Figure 12 demonstrates the typical sensitivity shift over temperature for $V_s = 5\text{ V}$. Sensitivity stability is optimized for $V_s = 5\text{ V}$, but is still very good over the specified range; it is typically better than $\pm 2\%$ over temperature at $V_s = 3\text{ V}$.

APPLICATIONS

POWER SUPPLY DECOUPLING

For most applications, a single 0.1 μF capacitor, C_{DC} , adequately decouples the accelerometer from noise on the power supply. However, in some cases, particularly where noise is present at the 140 kHz internal clock frequency (or any harmonic thereof), noise on the supply may cause interference on the ADXL213's output. If additional decoupling is needed, a 100 Ω (or smaller) resistor or ferrite beads may be inserted in the supply line of the ADXL213. Additionally, a larger bulk bypass capacitor (in the range of 1 μF to 22 μF) may be added in parallel to C_{DC} .

SETTING THE BANDWIDTH USING C_X AND C_Y

The ADXL213 has provisions for bandlimiting the X_{OUT} and Y_{OUT} pins. Capacitors must be added at these pins to implement low-pass filtering for antialiasing and noise reduction. The equation for the -3 dB bandwidth is

$$F_{-3\text{dB}} = 1/(2\pi(32\text{ k}\Omega) \times C_{(x,y)})$$

or more simply,

$$F_{-3\text{dB}} = 5\ \mu\text{F}/C_{(x,y)}$$

The tolerance of the internal resistor (R_{FILT}) can vary typically as much as $\pm 25\%$ of its nominal value (32 k Ω); thus, the bandwidth varies accordingly. A minimum capacitance of 2000 pF for C_X and C_Y is required in all cases.

Table 4. Filter Capacitor Selection, C_X and C_Y

| Bandwidth (Hz) | Capacitor (μF) |
|----------------|-----------------------------|
| 1 | 4.7 |
| 10 | 0.47 |
| 50 | 0.10 |
| 100 | 0.05 |
| 200 | 0.027 |
| 500 | 0.01 |

SELF TEST

The ST pin controls the self-test feature. When this pin is set to V_S , an electrostatic force is exerted on the beam of the accelerometer. The resulting movement of the beam allows the user to test if the accelerometer is functional. The typical change in output is 750 mg (corresponding to 23%). This pin may be left open circuit, or may be connected to common in normal use.

The ST pin should never be exposed to voltages greater than $V_S + 0.3$ V. If the system design is such that this condition cannot be guaranteed (i.e., multiple supply voltages present), a low V_F clamping diode between ST and V_S is recommended.

DESIGN TRADE-OFFS FOR SELECTING FILTER CHARACTERISTICS: THE NOISE/BW TRADE-OFF

The accelerometer bandwidth selected ultimately determines the measurement resolution (smallest detectable acceleration). Filtering can be used to lower the noise floor, which improves the resolution of the accelerometer. Resolution is dependent on the analog filter bandwidth at X_{FILT} and Y_{FILT} .

The output of the ADXL213 has a typical bandwidth of 2.5 kHz. The user must filter the signal at this point to limit aliasing errors. The analog bandwidth must be no more than one-fifth the PWM frequency to minimize aliasing. The analog bandwidth may be further decreased to reduce noise and improve resolution.

The ADXL213 noise has the characteristics of white Gaussian noise, which contributes equally at all frequencies and is described in terms of $\mu\text{g}/\sqrt{\text{Hz}}$ (i.e., the noise is proportional to the square root of the accelerometer's bandwidth). The user should limit bandwidth to the lowest frequency needed by the application in order to maximize the resolution and dynamic range of the accelerometer.

With the single pole roll-off characteristic, the typical noise of the ADXL213 is determined by

$$\text{rmsNoise} = (160\ \mu\text{g} / \sqrt{\text{Hz}}) \times (\sqrt{BW \times 1.6})$$

At 100 Hz the noise is

$$\text{rmsNoise} = (160\ \mu\text{g} / \sqrt{\text{Hz}}) \times (\sqrt{100 \times 1.6}) = 2\ \text{mg}$$

Often, the peak value of the noise is desired. Peak-to-peak noise can only be estimated by statistical methods. Table 5 is useful for estimating the probabilities of exceeding various peak values, given the rms value.

Table 5. Estimation of Peak-to-Peak Noise

| Peak-to-Peak Value | % of Time that Noise Will Exceed Nominal Peak-to-Peak Value |
|--------------------|-------------------------------------------------------------|
| 2 \times RMS | 32 |
| 4 \times RMS | 4.6 |
| 6 \times RMS | 0.27 |
| 8 \times RMS | 0.006 |

ADXL213

Peak-to-peak noise values give the best estimate of the uncertainty in a single measurement. Table 6 gives the typical noise output of the ADXL213 for various C_X and C_Y values.

Table 6. Filter Capacitor Selection (C_X , C_Y)

| Bandwidth(Hz) | C_X , C_Y (μ F) | RMS Noise (mg) | Peak-to-Peak Noise Estimate (mg) |
|---------------|-----------------------------|-------------------|-------------------------------------|
| 10 | 0.47 | 0.64 | 3.8 |
| 50 | 0.1 | 1.4 | 8.6 |
| 100 | 0.047 | 2 | 12 |
| 500 | 0.01 | 4.5 | 27.2 |

USING THE ADXL213 WITH OPERATING VOLTAGES OTHER THAN 5 V

The ADXL213 is tested and specified at $V_S = 5$ V; however, it can be powered with V_S as low as 3 V or as high as 6 V. Some performance parameters will change as the supply voltage is varied.

The ADXL213 output varies proportionally to supply voltage. At $V_S = 3$ V, the output sensitivity is typically 28%/g.

The zero g bias output is ratiometric, so the zero g output is nominally equal to 50% at all supply voltages.

The output noise also varies with supply voltage. At $V_S = 3$ V, the noise density is typically $200 \mu\text{g}/\sqrt{\text{Hz}}$.

Self-test response in g is roughly proportional to the square of the supply voltage. So at $V_S = 3$ V, the self-test response is equivalent to approximately 270 mg (typical), or 8%.

The supply current decreases as the supply voltage decreases. Typical current consumption at $V_{DD} = 3$ V is 450 μ A.

USING THE ADXL213 AS A DUAL-AXIS TILT SENSOR

One of the most popular applications of the ADXL213 is tilt measurement. An accelerometer uses the force of gravity as an input vector to determine the orientation of an object in space.

An accelerometer is most sensitive to tilt when its sensitive axis is perpendicular to the force of gravity, i.e., parallel to the earth's surface. At this orientation, its sensitivity to changes in tilt is highest. When the accelerometer is oriented on axis to gravity, i.e., near its +1 g or -1 g reading, the change in output acceleration per degree of tilt is negligible. When the accelerometer is perpendicular to gravity, its output changes nearly 17.5 mg per degree of tilt. At 45°, its output changes at only 12.2 mg per degree and resolution declines.

Dual-Axis Tilt Sensor: Converting Acceleration to Tilt

When the accelerometer is oriented so both its X and Y axes are parallel to the earth's surface, it can be used as a 2-axis tilt sensor with a roll axis and a pitch axis. Once the output signal from the accelerometer has been converted to an acceleration that varies between -1 g and +1 g, the output tilt in degrees is calculated as follows:

$$PITCH = ASIN(A_X/1 g)$$

$$ROLL = ASIN(A_Y/1 g)$$

Be sure to account for overranges. It is possible for the accelerometers to output a signal greater than ± 1 g due to vibration, shock, or other accelerations.

PIN CONFIGURATIONS AND FUNCTIONAL DESCRIPTIONS

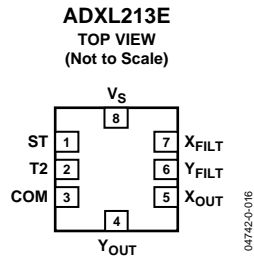

Figure 22. ADXL213 8-Lead CLCC

Table 7. ADXL213 8-Lead CLCC Pin Function Descriptions

| Pin No. | Mnemonic | Description |
|---------|-------------------|-------------------------------------|
| 1 | ST | Self Test |
| 2 | T2 | R _{SET} Resistor to Common |
| 3 | COM | Common |
| 4 | Y _{OUT} | Y Channel Output |
| 5 | X _{OUT} | X Channel Output |
| 6 | Y _{FILT} | Y Channel Filter Pin |
| 7 | X _{FILT} | X Channel Filter Pin |
| 8 | V _S | 3 V to 6 V |

ADXL213

OUTLINE DIMENSIONS

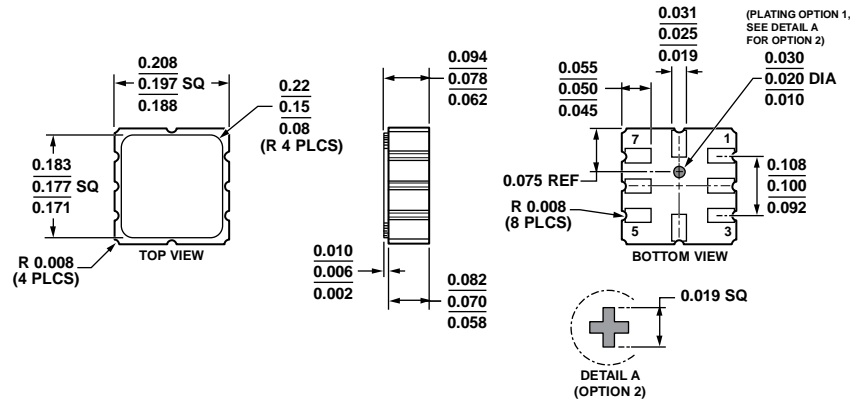

Figure 23. 8-Terminal Ceramic Leadless Chip Carrier [LCC]
(E-8-1)
Dimensions shown in inches

ESD CAUTION

ESD (electrostatic discharge) sensitive device. Electrostatic charges as high as 4000 V readily accumulate on the human body and test equipment and can discharge without detection. Although this product features proprietary ESD protection circuitry, permanent damage may occur on devices subjected to high energy electrostatic discharges. Therefore, proper ESD precautions are recommended to avoid performance degradation or loss of functionality.



ORDERING GUIDE

| Models ^{1, 2, 3} | Number of Axes | Specified Voltage (V) | Temperature Range | Package Description | Package Option |
|---------------------------|----------------|-----------------------|-------------------|--------------------------------------------|----------------|
| ADXL213AE | 1 | 5 | -40°C to +85°C | 8-Lead Ceramic Leadless Chip Carrier [LCC] | E-8-1 |
| ADXL213AE-REEL | 1 | 5 | -40°C to +85°C | 8-Lead Ceramic Leadless Chip Carrier [LCC] | E-8-1 |
| ADXL213WAEZA | 1 | 5 | -40°C to +85°C | 8-Lead Ceramic Leadless Chip Carrier [LCC] | E-8-1 |
| ADXL213WAEZA-REEL | 1 | 5 | -40°C to +85°C | 8-Lead Ceramic Leadless Chip Carrier [LCC] | E-8-1 |
| ADXL213EB | | | | Evaluation Board | |

¹ Z = RoHS Compliant Part.

² The ADXL213AE and ADXL213AE-REEL models include a Lead Finish—Gold over Nickel over Tungsten.

³ W = Qualified for Automotive Applications.

AUTOMOTIVE PRODUCTS

The ADXL213W models are available with controlled manufacturing to support the quality and reliability requirements of automotive applications. Note that these automotive models may have specifications that differ from the commercial models; therefore, designers should review the Specifications section of this data sheet carefully. Only the automotive grade products shown are available for use in automotive applications. Contact your local Analog Devices account representative for specific product ordering information and to obtain the specific Automotive Reliability reports for these models.