

Ultra-Low Offset/Drift, Precision Instrumentation Amplifiers with REF Buffer

General Description

The MAX4208/MAX4209 ultra-low offset and drift instrumentation amplifiers feature exceptional precision specifications, low power consumption, rail-to-rail output, excellent gain-bandwidth product, and buffered REF/MODE input in a very small μ MAX[®] package. These devices use a spread-spectrum, autozeroing technique that constantly measures and corrects the input offset, eliminating drift over time and temperature and the effect of $1/f$ noise. This technique achieves less than $20\mu\text{V}$ offset voltage, allows ground-sensing capability, provides ultra-low CMOS input bias current and increased common-mode rejection performance.

The MAX4208/MAX4209 provide high-impedance inputs optimized for small-signal differential voltages ($\pm 100\text{mV}$). All devices provide a gain-bandwidth product of 750kHz .

The MAX4208 provides an adjustable gain with two external resistors or unity gain with FB connected to OUT. The MAX4209 is available with a fixed gain of 100V/V with $\pm 0.03\%$ (typ) accuracy. Both devices include a reference input (REF) to level-shift the output, allowing for bipolar signals in single-supply applications. In both devices, REF/MODE is an input to a precision unity-gain buffer, which sets the REF voltage to level-shift the output. The internal REF buffer allows the reference to be set by a simple resistive divider or an ADC reference without any loading error.

The MAX4208/MAX4209 operate with a 2.85V to 5.5V single-supply voltage and consume only $750\mu\text{A}$ of quiescent current (when the internal buffer is off) and only $1.4\mu\text{A}$ in shutdown mode. These amplifiers also operate with $\pm 2.5\text{V}$ dual supplies with REF connected to ground and REF/MODE to V_{SS} . The MAX4208/MAX4209 are available in space-saving 8-pin μ MAX packages and are specified over the automotive operating temperature range (-40°C to $+125^\circ\text{C}$).

Applications

Automotive Transducer Applications
Strain-Gauge Amplifiers
Industrial Process Control
Battery-Powered Medical Equipment
Precision Low-Side Current Sense
Notebook Computers
Differential Voltage Amplification

μ MAX is a registered trademark of Maxim Integrated Products, Inc.

For pricing, delivery, and ordering information, please contact Maxim Direct at 1-888-629-4642, or visit Maxim's website at www.maxim-ic.com.

Features

- ◆ Ultra-Low Input Offset Voltage $\pm 20\mu\text{V}$ (max) at $+25^\circ\text{C}$
- ◆ $\pm 0.25\%$ (max) Gain Error
- ◆ Low $0.2\mu\text{V}/^\circ\text{C}$ Offset Voltage Drift
- ◆ 1pA CMOS Input Bias Current
- ◆ True Ground Sensing with Rail-to-Rail Output
- ◆ Buffered REF Input for High Accuracy and Bipolar Operation
- ◆ 2.85V to 5.5V Single-Supply Operation (or $\pm 1.425\text{V}$ to $\pm 2.75\text{V}$ Dual Supplies)
- ◆ $750\mu\text{A}$ Supply Current
- ◆ $1.4\mu\text{A}$ Shutdown Mode
- ◆ 750kHz Gain-Bandwidth Product
- ◆ Operate Over the -40°C to $+125^\circ\text{C}$ Automotive Temperature Range
- ◆ Tiny 8-Pin μ MAX Package

Ordering Information

PART	TEMP RANGE	PIN-PACKAGE	GAIN (V/V)
MAX4208AUA+T	-40°C to $+125^\circ\text{C}$	8 μ MAX	ADJ
MAX4209HAUA+T	-40°C to $+125^\circ\text{C}$	8 μ MAX	100

Note: All 8-pin μ MAX packages have package code U8-1.
+Denotes a lead(Pb)-free/RoHS-compliant package.

Typical Application Circuit

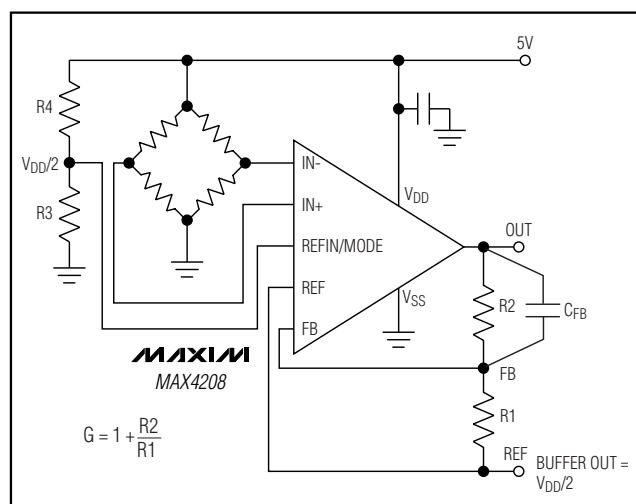

Ultra-Low Offset/Drift, Precision Instrumentation Amplifiers with REF Buffer

ABSOLUTE MAXIMUM RATINGS

V _{DD} to V _{SS}	-0.3V to +6V	Operating Temperature Range	-40°C to +125°C
All Other Pins	(V _{SS} - 0.3V) to (V _{DD} + 0.3V)	Junction Temperature	+150°C
OUT Short-Circuit Duration	Continuous	Storage Temperature Range	-65°C to +150°C
Current Into OUT, V _{DD} , and V _{SS}	±25mA	Lead Temperature (soldering, 10s)	+300°C
Current Into Any Other Pin	±20mA		
Continuous Power Dissipation (T _A = +70°C)			
8-Pin μ MAX (derate 4.5mW/°C above +70°C)	362mW		

Stresses beyond those listed under "Absolute Maximum Ratings" may cause permanent damage to the device. These are stress ratings only, and functional operation of the device at these or any other conditions beyond those indicated in the operational sections of the specifications is not implied. Exposure to absolute maximum rating conditions for extended periods may affect device reliability.

ELECTRICAL CHARACTERISTICS

(V_{DD} = 5V, V_{SS} = 0V, V_{CM} = V_{REF} = V_{DD}/2, V_{REFIN/MODE} = V_{SS}, R_L = 100k Ω to V_{DD}/2, V_{DIFF} = (V_{IN+} - V_{IN-}) = 0V, MAX4208 set for G = 100V/V (R1 = 1k Ω , R2 = 99k Ω), T_A = +25°C, unless otherwise noted.) (Note 1)

PARAMETER	SYMBOL	CONDITIONS	MIN	TYP	MAX	UNITS
INPUT DC CHARACTERISTICS						
Input Offset Voltage	V _{OS}	MAX4208, G = 100V/V		±3	±20	μ V
		MAX4209H, G = 100V/V		±3	±20	
Input Bias Current	I _B	-100mV \leq V _{DIFF} \leq +100mV (Note 3)		1		pA
Input Offset Current	I _{OS}	-100mV \leq V _{DIFF} \leq +100mV (Note 3)		1		pA
Input Resistance	R _{IN}	V _{CM} = V _{DD} /2	Differential mode	2		G Ω
			Common mode	2		
Gain Error		-20mV \leq V _{DIFF} \leq +20mV MAX4208, G = 100V/V		0.05	±0.25	%
		-20mV \leq V _{DIFF} \leq +20mV MAX4209H, G = 100V/V		0.05	±0.25	
Gain Nonlinearity (Note 2)		MAX4208, G = 100V/V		25	150	ppm
		MAX4209H, G = 100V/V		25	150	
Input Common-Mode Range	V _{CM}	Guaranteed by CMRR test	V _{SS} - 0.1		V _{DD} - 1.30	V
Input Common-Mode Rejection Ratio	CMRR	V _{CM} = (V _{SS} - 0.1V) to (V _{DD} - 1.30V)	106	135		dB

Ultra-Low Offset/Drift, Precision Instrumentation Amplifiers with REF Buffer

MAX4208/MAX4209

ELECTRICAL CHARACTERISTICS (continued)

($V_{DD} = 5V$, $V_{SS} = 0V$, $V_{CM} = V_{REF} = V_{DD}/2$, $V_{REFIN/MODE} = V_{SS}$, $R_L = 100k\Omega$ to $V_{DD}/2$, $V_{DIFF} = (V_{IN+} - V_{IN-}) = 0V$, MAX4208 set for $G = 100V/V$ ($R_1 = 1k\Omega$, $R_2 = 99k\Omega$), $T_A = +25^\circ C$, unless otherwise noted.) (Note 1)

PARAMETER	SYMBOL	CONDITIONS	MIN	TYP	MAX	UNITS
Power-Supply Rejection Ratio	PSRR	$V_{DD} = 2.85V$ to $5.5V$, $V_{REF} = V_{CM} = (V_{SS} + 0.5V)$	100	125		dB
REFIN/MODE AND REF DC CHARACTERISTICS						
REFIN/MODE Buffer Input Offset Voltage		(Note 2)		± 10	± 40	μV
REFIN/MODE Input-Voltage Low	V_{IL}	Reference buffer is OFF		V_{SS}	$V_{SS} + 0.05$	V
REFIN/MODE Input-Voltage High	V_{IH}	Shutdown mode	$V_{DD} - 0.2$	V_{DD}		V
REFIN/MODE Buffered Reference Input Range	$V_{REFIN/MODE}$	Reference buffer is ON, guaranteed by REFIN/MODE CMRR test	$V_{SS} + 0.2$		$V_{DD} - 1.3$	V
REFIN/MODE Buffer Common-Mode Rejection Ratio		$(V_{SS} + 0.2V) \leq V_{REF/MODE} \leq (V_{DD} - 1.3V)$ (Note 2)	106	135		dB
REFIN/MODE Buffer Power-Supply Rejection Ratio		$V_{DD} = 2.85V$ to $5.5V$, $V_{REF/MODE} = V_{CM} = (V_{SS} + 0.5V)$	100	125		dB
REFIN/MODE Bias Current	I_{REFIN}	$V_{SS} < V_{REFIN/MODE} < V_{DD}$ (Note 3)		1		μA
REF Common-Mode Range		Guaranteed by reference CMRR test (Note 4)	V_{SS}		$V_{DD} - 1.30$	V
REF Common-Mode Rejection Ratio		$V_{SS} \leq V_{REF} \leq (V_{DD} - 1.30V)$ (Note 4)	106	135		dB
REF, FB Bias Current		MAX4208 (Note 3)		1		μA
REF Input Current (MAX4209)	I_{REF}	$V_{DIFF} = 0V$ (Note 5)		± 10		nA
		$V_{DIFF} = \pm 100mV$ (Note 5)		± 100		μA
OUTPUT DC CHARACTERISTICS						
Output-Voltage Swing (Notes 6 and 7)	V_{OH}	$V_{DD} - V_{OUT}$	$R_L = 100k\Omega$	30	45	mV
			$R_L = 10k\Omega$	50	70	
			$R_L = 1k\Omega$	250	325	
	V_{OL}	$V_{OUT} - V_{SS}$	$R_L = 100k\Omega$	30	40	
			$R_L = 10k\Omega$	50	65	
			$R_L = 1k\Omega$	250	285	
Short-Circuit Current	I_{SC}	Source		+20		mA
		Sink		-25		
Short-Circuit Recovery Time				0.50		ms
AC CHARACTERISTICS						
Gain-Bandwidth Product	GBW	MAX4208, $G = 1V/V$		750		kHz
Small-Signal Bandwidth	BW	MAX4209H, $G = 100V/V$		7.5		kHz
Slew Rate (Note 8)	SR	MAX4208, $G = 1V/V$, $V_{OUT} = 100mV$ step		80		V/ms

Ultra-Low Offset/Drift, Precision Instrumentation Amplifiers with REF Buffer

ELECTRICAL CHARACTERISTICS (continued)

($V_{DD} = 5V$, $V_{SS} = 0V$, $V_{CM} = V_{REF} = V_{DD}/2$, $V_{REFIN/MODE} = V_{SS}$, $R_L = 100k\Omega$ to $V_{DD}/2$, $V_{DIFF} = (V_{IN+} - V_{IN-}) = 0V$, MAX4208 set for $G = 100V/V$ ($R_1 = 1k\Omega$, $R_2 = 99k\Omega$), $T_A = +25^\circ C$, unless otherwise noted.) (Note 1)

PARAMETER	SYMBOL	CONDITIONS		MIN	TYP	MAX	UNITS
Settling Time	t_s	To within 0.1% of final value	MAX4208, $G = 1V/V$	10		μs	
			MAX4209H	120			
Maximum Capacitive Load	C_L	No sustained oscillations		200		μF	
Input-Voltage Noise	e_n	$f = 0.1Hz$ to $10Hz$		2.5		μV_{P-P}	
		$f = 1kHz$		140		nV/\sqrt{Hz}	
Power-Up Time		To within 0.1% of final value		20		ms	
Shutdown Enable/Disable Time	t_{EN} , t_{DIS}			20		ms	
POWER SUPPLY							
Supply Voltage	V_{DD}	Guaranteed by PSRR test		2.85	5.50		V
Supply Current	I_{DD}	$V_{REFIN/MODE} = V_{SS}$, buffer OFF	$V_{DD} = 5V$	0.75	1.30		mA
		$(V_{SS} + 0.2V) \leq V_{REFIN/MODE} \leq (V_{DD} - 1.3V)$, buffer ON	$V_{DD} = 5V$	1.40	2.30		
		$V_{REFIN/MODE} = V_{DD}$, shutdown mode			1.4	5.0	

ELECTRICAL CHARACTERISTICS

($V_{DD} = 5V$, $V_{SS} = 0V$, $V_{CM} = V_{REF} = V_{DD}/2$, $V_{REFIN/MODE} = V_{SS}$, $R_L = 100k\Omega$ to $V_{DD}/2$, $V_{DIFF} = (V_{IN+} - V_{IN-}) = 0V$, MAX4208 set for $G = 100V/V$ ($R_1 = 1k\Omega$, $R_2 = 99k\Omega$), $T_A = -40^\circ C$ to $+125^\circ C$, unless otherwise noted.) (Note 1)

PARAMETER	SYMBOL	CONDITIONS		MIN	TYP	MAX	UNITS
INPUT DC CHARACTERISTICS							
Input Offset Voltage	V_{OS}	MAX4208, $G = 100V/V$	$T_A = +25^\circ C$ to $+85^\circ C$	± 45		μV	
			$T_A = -40^\circ C$ to $+125^\circ C$	± 60			
		MAX4209H, $G = 100V/V$	$T_A = +25^\circ C$ to $+85^\circ C$	± 30			
			$T_A = -40^\circ C$ to $+125^\circ C$	± 40			
Input Offset Voltage Temperature Drift (Note 2)	TCV_{OS}	MAX4208, $G = 100V/V$	$T_A = +25^\circ C$ to $+85^\circ C$	0.1	± 0.45		$\mu V/^\circ C$
			$T_A = -40^\circ C$ to $+125^\circ C$	0.1	± 0.45		
		MAX4209H, $G = 100V/V$	$T_A = +25^\circ C$ to $+85^\circ C$	0.01	± 0.17		
			$T_A = -40^\circ C$ to $+125^\circ C$	0.01	± 0.17		
Input Bias Current		(Note 3) $-100mV \leq V_{DIFF} < +100mV$	$T_A = +85^\circ C$	10		μA	
			$T_A = +125^\circ C$	20			
Gain Error		MAX4208, $G = 100V/V$, $-20mV \leq V_{DIFF} \leq +20mV$	$T_A = +25^\circ C$ to $+85^\circ C$	0.30		%	
			$T_A = -40^\circ C$ to $+125^\circ C$	0.35			
		MAX4209H, $G = 100V/V$, $-20mV \leq V_{DIFF} \leq +20mV$	$T_A = +25^\circ C$ to $+85^\circ C$	0.30			
			$T_A = -40^\circ C$ to $+125^\circ C$	0.35			

Ultra-Low Offset/Drift, Precision Instrumentation Amplifiers with REF Buffer

MAX4208/MAX4209

ELECTRICAL CHARACTERISTICS (continued)

($V_{DD} = 5V$, $V_{SS} = 0V$, $V_{CM} = V_{REF} = V_{DD}/2$, $V_{REFIN/MODE} = V_{SS}$, $R_L = 100k\Omega$ to $V_{DD}/2$, $V_{DIFF} = (V_{IN+} - V_{IN-}) = 0V$, MAX4208 set for $G = 100V/V$ ($R_1 = 1k\Omega$, $R_2 = 99k\Omega$), $T_A = -40^\circ C$ to $+125^\circ C$, unless otherwise noted.) (Note 1)

PARAMETER	SYMBOL	CONDITIONS		MIN	TYP	MAX	UNITS
Gain Error Temperature Drift (Note 2)		$-20mV \leq V_{DIFF} \leq +20mV$ (MAX4208), $G = 100V/V$	$T_A = -40^\circ C$ to $+125^\circ C$		50	180	ppm/ $^\circ C$
		$-20mV \leq V_{DIFF} \leq +20mV$ (MAX4209H), $G = 100V/V$	$T_A = -40^\circ C$ to $+125^\circ C$		50	180	
Gain Nonlinearity (Note 2)	G_{NL}	MAX4208, $G = 100V/V$	$T_A = +25^\circ C$ to $+85^\circ C$			210	ppm
			$T_A = -40^\circ C$ to $+125^\circ C$			700	
		MAX4209H, $G = 100V/V$	$T_A = +25^\circ C$ to $+85^\circ C$			210	
			$T_A = -40^\circ C$ to $+125^\circ C$			700	
Input Common-Mode Range	V_{CM}	Guaranteed by CMRR test, $T_A = -40^\circ C$ to $+125^\circ C$		$V_{SS} - 0.1$		$V_{DD} - 1.6$	V
Input Common-Mode Rejection Ratio	CMRR	$(V_{SS} - 0.1V) \leq V_{CM} \leq (V_{DD} - 1.6V)$	$T_A = +25^\circ C$ to $+85^\circ C$	96			dB
			$T_A = -40^\circ C$ to $+125^\circ C$	90			
Power-Supply Rejection Ratio	PSRR	$V_{DD} = 2.85V$ to $5.5V$, $V_{REF} = V_{CM} = V_{SS} + 0.5V$	$T_A = +25^\circ C$ to $+85^\circ C$	96			dB
			$T_A = -40^\circ C$ to $+125^\circ C$	90			
REFIN/MODE AND REF DC CHARACTERISTICS							
REFIN/MODE Buffer Input Offset Voltage		$T_A = +25^\circ C$ to $+85^\circ C$				100	μV
		$T_A = -40^\circ C$ to $+125^\circ C$				100	
REFIN/MODE Buffered Reference Input Range	$V_{REFIN/MODE}$	Reference buffer is ON, guaranteed by REFIN/MODE CMRR test		$V_{SS} + 0.2$		$V_{DD} - 1.6$	V
REFIN/MODE Input-Voltage Low	V_{IL}	Reference buffer is OFF				$V_{SS} + 0.05$	V

Ultra-Low Offset/Drift, Precision Instrumentation Amplifiers with REF Buffer

ELECTRICAL CHARACTERISTICS (continued)

($V_{DD} = 5V$, $V_{SS} = 0V$, $V_{CM} = V_{REF} = V_{DD}/2$, $V_{REFIN/MODE} = V_{SS}$, $R_L = 100k\Omega$ to $V_{DD}/2$, $V_{DIFF} = (V_{IN+} - V_{IN-}) = 0V$, MAX4208 set for $G = 100V/V$ ($R_1 = 1k\Omega$, $R_2 = 99k\Omega$), $T_A = -40^\circ\text{C}$ to $+125^\circ\text{C}$, unless otherwise noted.) (Note 1)

PARAMETER	SYMBOL	CONDITIONS		MIN	TYP	MAX	UNITS
REFIN/MODE Input-Voltage High	V_{IH}	MAX4208/MAX4209 in shutdown		$V_{DD} - 0.2$			V
REFIN/MODE Buffer Common-Mode Rejection Ratio		$(V_{SS} + 0.2V) \leq V_{REF} \leq (V_{DD} - 1.6V)$	$T_A = +25^\circ\text{C}$ to $+85^\circ\text{C}$	96			dB
			$T_A = -40^\circ\text{C}$ to $+125^\circ\text{C}$	90			
REF Common-Mode Range (Note 4)		Guaranteed by REF CMRR test		V_{SS}		$V_{DD} - 1.6$	V
REF Common-Mode Rejection Ratio		$V_{SS} \leq V_{REF} \leq (V_{DD} - 1.6V)$	$T_A = +25^\circ\text{C}$ to $+85^\circ\text{C}$	96			dB
			$T_A = -40^\circ\text{C}$ to $+125^\circ\text{C}$	90			
REFIN/MODE Buffer Power-Supply Rejection Ratio		$V_{DD} = 2.85V$ to $5.5V$, $V_{REFIN/MODE} = V_{CM} = (V_{SS} + 0.5V)$	$T_A = +25^\circ\text{C}$ to $+85^\circ\text{C}$	96			dB
			$T_A = -40^\circ\text{C}$ to $+125^\circ\text{C}$	90			
OUTPUT DC CHARACTERISTICS							
Output-Voltage Swing (Note 6)	V_{OH}	$V_{DD} - V_{OUT}$	$R_L = 100k\Omega$	60			mV
			$R_L = 10k\Omega$	90			
			$R_L = 1k\Omega$	375			
	V_{OL}	$V_{OUT} - V_{SS}$	$R_L = 100k\Omega$	50			
			$R_L = 10k\Omega$	75			
			$R_L = 1k\Omega$	325			
POWER SUPPLY							
Supply Voltage	V_{DD}	Guaranteed by PSRR test		2.85		5.50	V
Supply Current		$V_{REFIN/MODE} = V_{SS}$, buffer OFF	$V_{DD} = 5V$	1.70			mA
		$(V_{SS} + 0.2V) \leq V_{REFIN/MODE} \leq (V_{DD} - 1.6V)$, buffer ON	$V_{DD} = 5V$	3.0			
		REFIN/MODE = V_{DD} , shutdown mode		10			

- Note 1:** Specifications are 100% production tested at $+25^\circ\text{C}$, unless otherwise noted. Limits over temperature are guaranteed by design.
- Note 2:** Guaranteed by design. Thermocouple and leakage effects preclude measurement of this parameter during production testing. Devices are screened during production testing to eliminate defective units.
- Note 3:** $IN+$ and $IN-$ are gates to CMOS transistors with typical input bias current of 1pA . CMOS leakage is so small that it is impractical to test and guarantee in production. Max V_{DIFF} is $\pm 100\text{mV}$. Devices are screened during production testing to eliminate defective units. For the MAX4208, when there are no external resistors, the input bias current at FB and REF is 1pA (typ).
- Note 4:** Setting REF to ground (V_{SS}) is allowed if the REF buffer is off. The unity-gain buffer is on when $V_{REFIN/MODE}$ is between $0.15V$ and $(V_{DD} - 1.3V)$. In this range, $V_{REF} = V_{REFIN/MODE} \pm 40\mu\text{V}$ (maximum buffer input offset voltage over temperature). Setting REFIN/MODE to V_{DD} puts the part in shutdown ($I_{DD} = 1.4\mu\text{A}$).
- Note 5:** This is the REF current needed to directly drive the end terminal of the gain-setting resistors when REFIN/MODE is connected to V_{SS} to put the buffer in high-impedance mode. The REF input current is tested at the gain of 100. At gain 10 and 1000, $I_{REF} = \pm 100\mu\text{A}$ and $3.4\mu\text{A}$, respectively at $+25^\circ\text{C}$. See the *Detailed Description*.
- Note 6:** Output swing high (V_{OH}) and output swing low (V_{OL}) are measured only on $G = 100$ and $G = 1000$ devices. Devices with $G = 1$ and $G = 10$ have output swing high limited by the range of V_{REF} , V_{CM} , and V_{DIFF} (see the *Output Swing* section).
- Note 7:** Maximum range for V_{DIFF} is from -100mV to $+100\text{mV}$.
- Note 8:** At $G = 100V/V$ and $G = 1000V/V$, these instrumentation amplifiers are bandwidth limited and not capable of slew-rate-limited dV/dt .

Ultra-Low Offset/Drift, Precision Instrumentation Amplifiers with REF Buffer

Typical Operating Characteristics

($V_{DD} = 5V$, $V_{SS} = 0V$, $V_{CM} = V_{REF} = V_{DD}/2$, $V_{REFIN/MODE} = V_{SS}$, $R_L = 100k\Omega$ to $V_{DD}/2$, $V_{DIFF} = (V_{IN+} - V_{IN-}) = 0V$, MAX4208 set for $G = 100V/V$ ($R1 = 1k\Omega$, $R2 = 99k\Omega$), $T_A = +25^\circ C$, unless otherwise noted.)

MAX4208/MAX4209

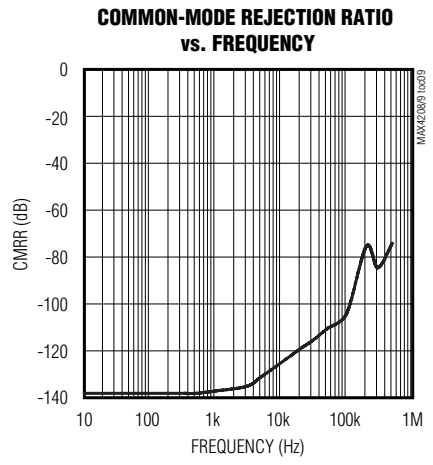
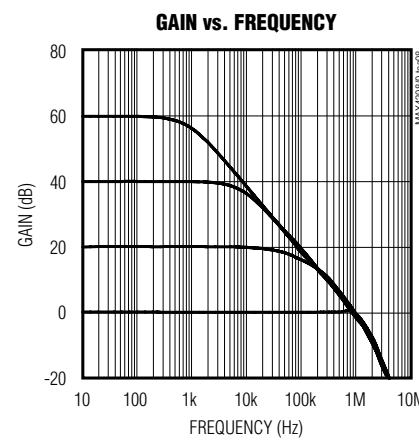
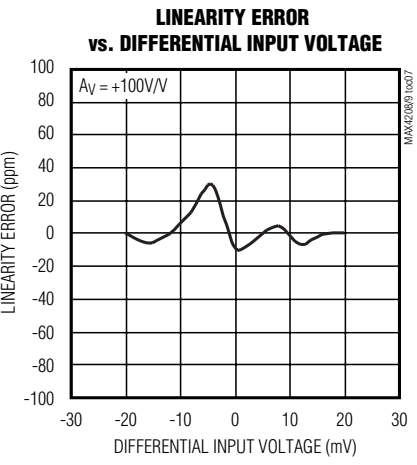
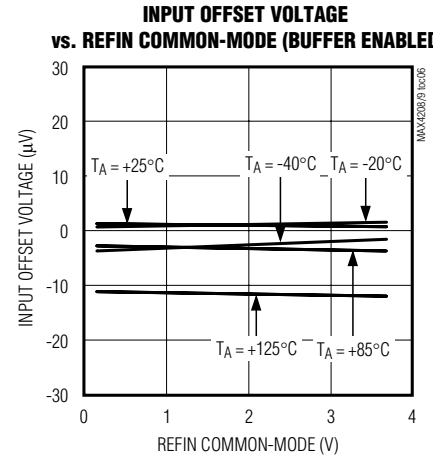
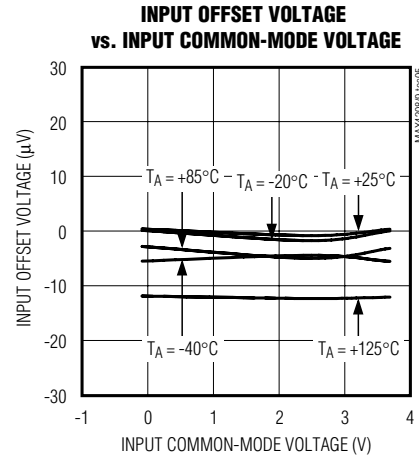
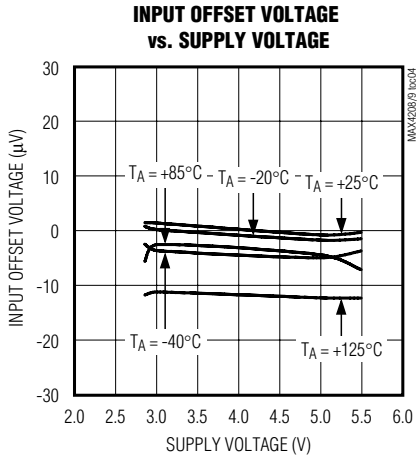
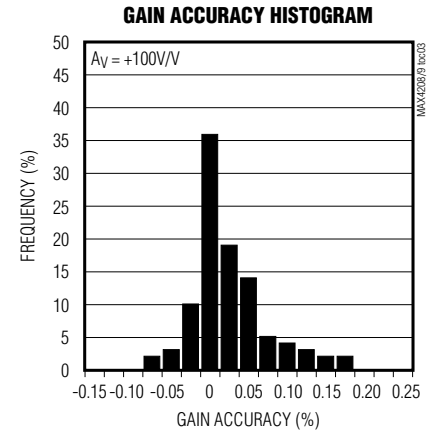
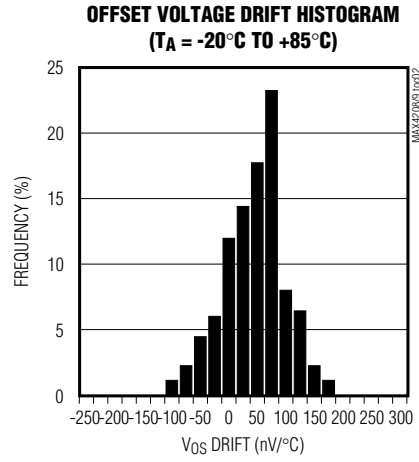
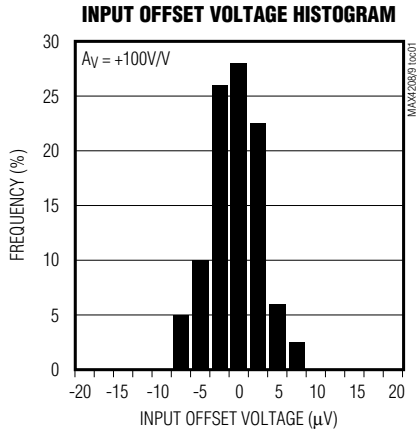

Ultra-Low Offset/Drift, Precision Instrumentation Amplifiers with REF Buffer

Typical Operating Characteristics (continued)

($V_{DD} = 5V$, $V_{SS} = 0V$, $V_{CM} = V_{REF} = V_{DD}/2$, $V_{REFIN/MODE} = V_{SS}$, $R_L = 100k\Omega$ to $V_{DD}/2$, $V_{DIFF} = (V_{IN+} - V_{IN-}) = 0V$, MAX4208 set for $G = 100V/V$ ($R1 = 1k\Omega$, $R2 = 99k\Omega$), $T_A = +25^\circ C$, unless otherwise noted.)

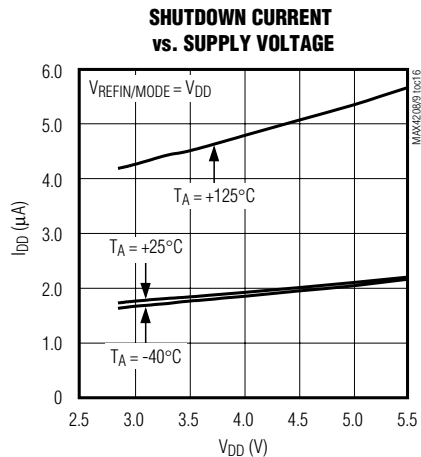
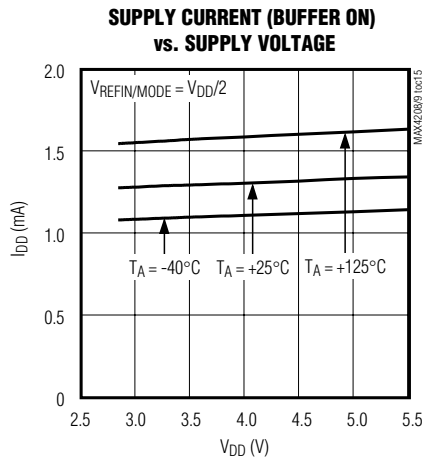
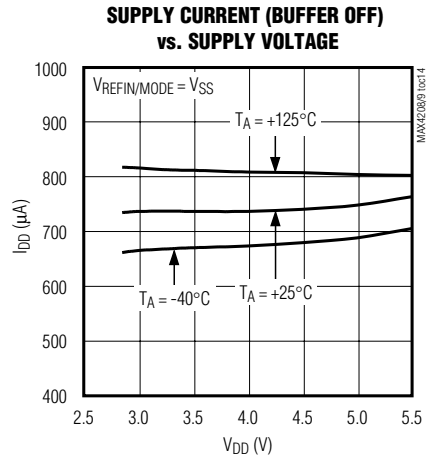
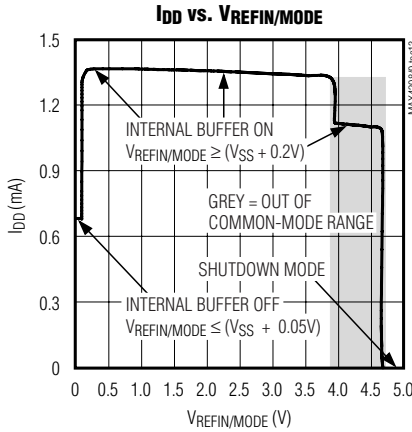
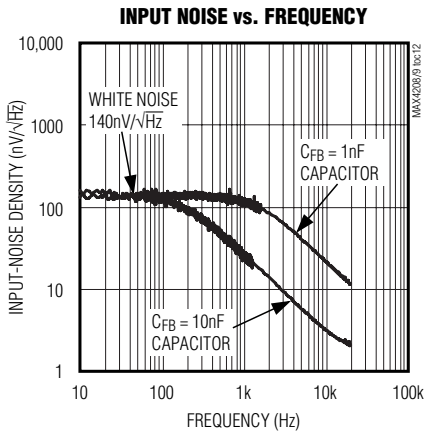
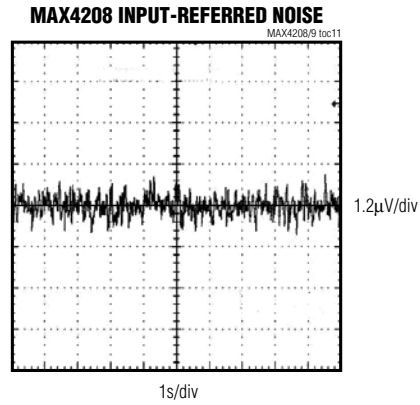
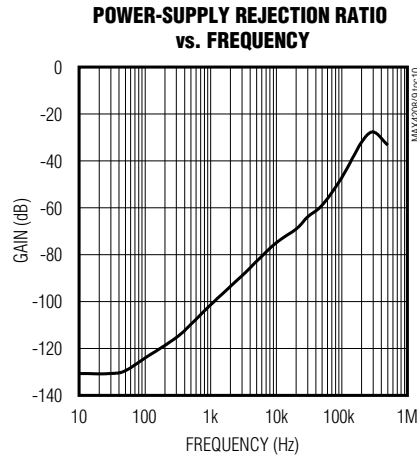

Ultra-Low Offset/Drift, Precision Instrumentation Amplifiers with REF Buffer

Typical Operating Characteristics (continued)

($V_{DD} = 5V$, $V_{SS} = 0V$, $V_{CM} = V_{REF} = V_{DD}/2$, $V_{REFIN/MODE} = V_{SS}$, $R_L = 100k\Omega$ to $V_{DD}/2$, $V_{DIFF} = (V_{IN+} - V_{IN-}) = 0V$, MAX4208 set for $G = 100V/V$ ($R1 = 1k\Omega$, $R2 = 99k\Omega$), $T_A = +25^\circ C$, unless otherwise noted.)

MAX4208/MAX4209

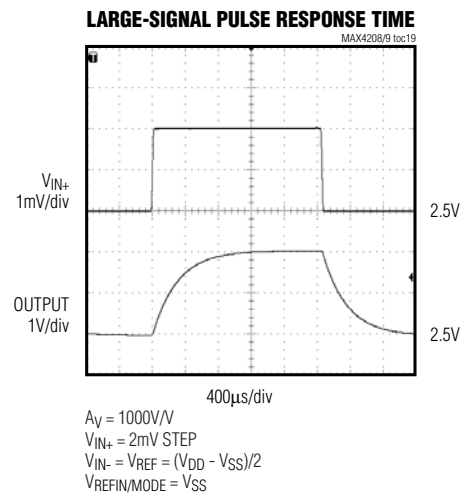
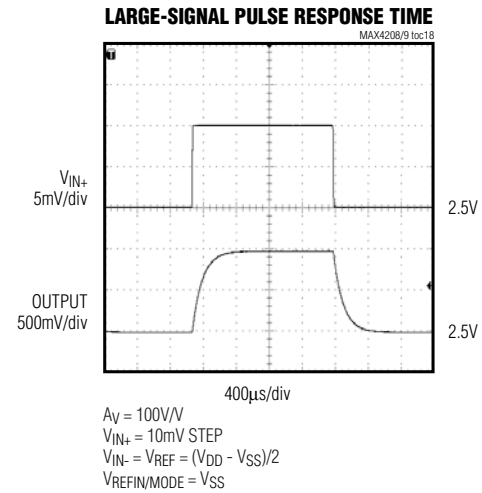
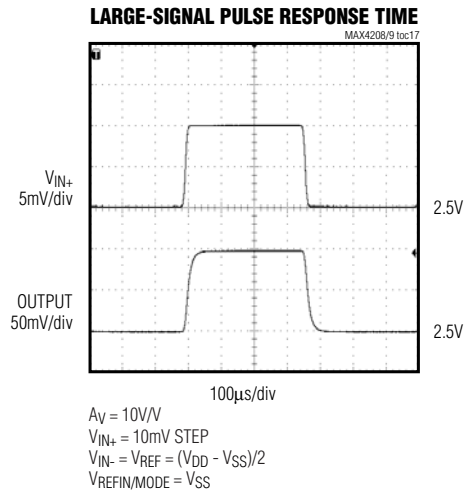

Ultra-Low Offset/Drift, Precision Instrumentation Amplifiers with REF Buffer

Typical Operating Characteristics (continued)

($V_{DD} = 5V$, $V_{SS} = 0V$, $V_{CM} = V_{REF} = V_{DD}/2$, $V_{REFIN/MODE} = V_{SS}$, $R_L = 100k\Omega$ to $V_{DD}/2$, $V_{DIFF} = (V_{IN+} - V_{IN-}) = 0V$, MAX4208 set for $G = 100V/V$ ($R_1 = 1k\Omega$, $R_2 = 99k\Omega$), $T_A = +25^\circ C$, unless otherwise noted.)

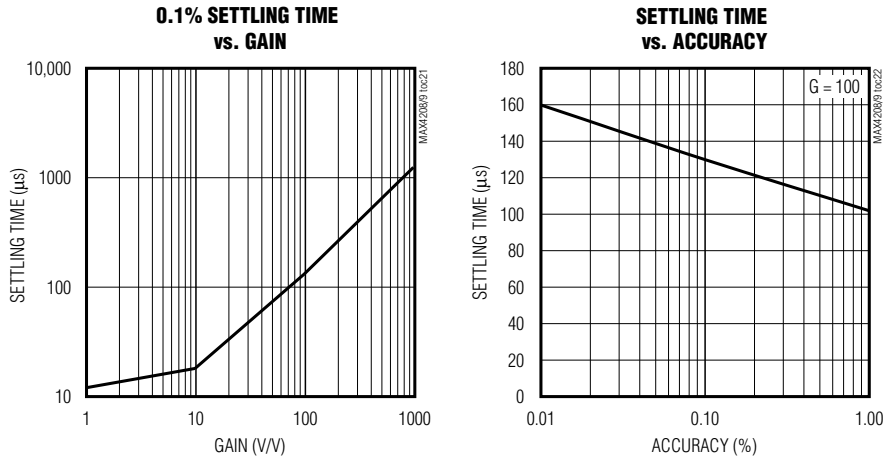

Pin Description

PIN	NAME	FUNCTION
1	REFIN/MODE	Reference/Shutdown Mode Input. Trimode function is as follows: Connect to V_{DD} to put the device in shutdown mode. Connect to an external reference (between $V_{SS} + 0.2V$ and $V_{DD} - 1.3V$) to buffer the voltage at REFIN/MODE. Using the REF buffer allows the use of a simple resistor-divider or high-impedance external reference to set the OUT level at $0mV$ IN with minimum error. Connect to V_{SS} to force the internal buffer output into a high-impedance state to allow external direct drive of REF.
2	IN-	Negative Differential Input
3	IN+	Positive Differential Input
4	V_{SS}	Negative Supply Input. Bypass V_{SS} to ground with a $0.1\mu F$ capacitor or connect to ground for single-supply operation.
5	REF	Output Reference Level. REF sets the OUT voltage for zero differential input. The internal buffer sets the voltage at REF when the voltage at REFIN/MODE is between $V_{SS} + 0.2V$ and $V_{DD} - 1.3V$.
6	FB	Feedback Input. Connect FB to the center tap of an external resistive divider from OUT to REF to set the gain for the MAX4208. MAX4209 FB is internally connected to gain-setting resistors. Connect an optional capacitor, C_{FB} , from OUT to FB to reduce autozero noise.
7	OUT	Amplifier Output
8	V_{DD}	Positive Supply Input. Bypass V_{DD} to ground with a $0.1\mu F$ capacitor.

Ultra-Low Offset/Drift, Precision Instrumentation Amplifiers with REF Buffer

MAX4208/MAX4209

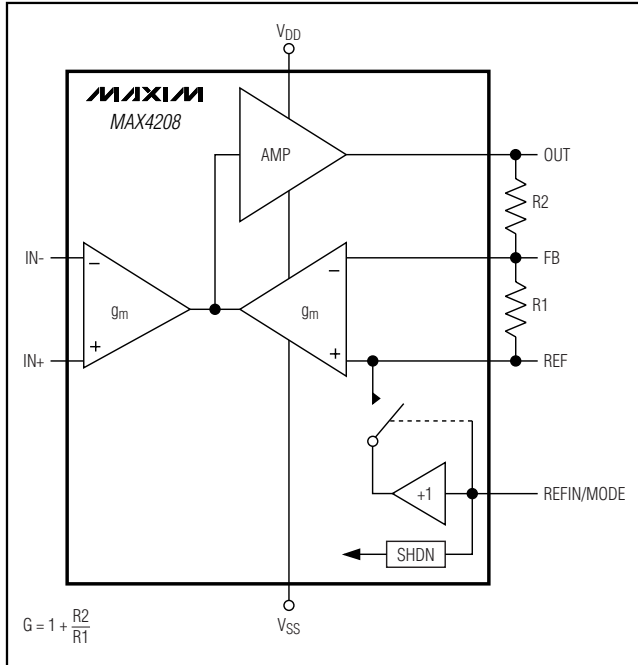

Figure 1. MAX4208 Functional Diagram

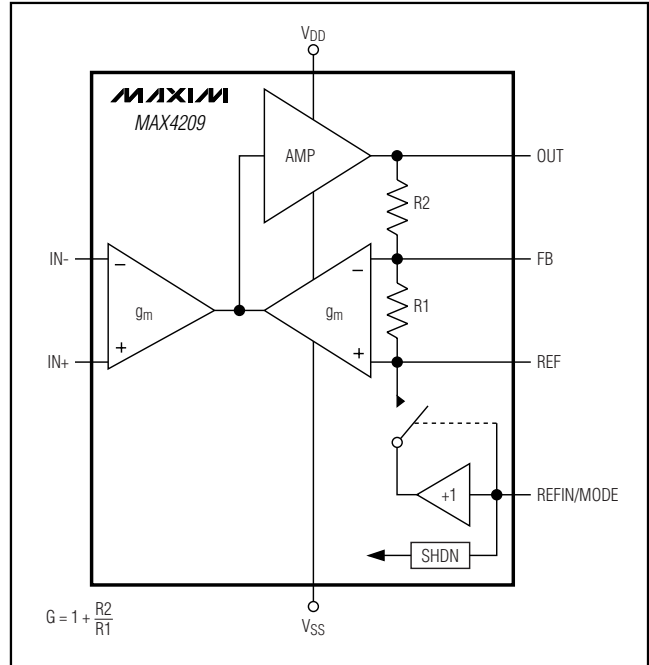

Figure 2. MAX4209 Functional Diagram

Detailed Description

The MAX4208/MAX4209 family of instrumentation amplifiers implements a spread-spectrum, autozeroing technique that minimizes the input offset error, drift over time and temperature, and the effect of 1/f noise. Unlike the traditional three-op amp instrumentation amplifier, this technique allows true ground-sensing capability combined with a low input bias current and increased common-mode rejection.

The differential input signal is converted to a current by an input transconductance stage. An output transconductance stage converts a portion of the output voltage (equal to the output voltage divided by the gain) into another precision current. These two currents are subtracted and the result is fed to a loop amplifier with sufficient gain to minimize errors (Figures 1 and 2). The MAX4209 has a factory-trimmed gain of 100V/V. The MAX4208 has an adjustable gain, set with an external pair of resistors between OUT, FB, and REF (Figure 1). The MAX4208/MAX4209 have an output reference input (REF) that is connected to an external reference for bipolar operation of the device. For single-supply operation, the range for V_{REF} is 0V to (V_{DD} - 1.3V). Although full output-swing capability and maximum symmetrical dynamic range is obtained at REF = V_{DD}/2, the optimal V_{REF} setting depends on the supply voltage and output-voltage

swing needed by the application. The maximum recommended differential input voltage is ±100mV. Linearity and accuracy are degraded above that level. The MAX4208/MAX4209 operate with single 2.85V to 5.5V supply voltages or dual ±1.425V to ±2.75V supplies.

The MAX4208/MAX4209 have a shutdown feature to reduce the supply current to 1.4μA (typ) when REFIN/MODE is connected to V_{DD}.

REF, REFIN/MODE, and Internal REFIN Buffer of the MAX4208/MAX4209

In a single-supply system, bipolar operation of an instrumentation amplifier requires the application of a voltage reference (REF) to set the output voltage level when a zero differential voltage is applied to the input. The output swing is around this reference level, which is usually set to half of the supply voltage for the largest swing and dynamic range.

In many instrumentation amplifiers, the gain-setting resistors as well as the R_L are connected between OUT and REF. OUT can sink and source current but the need for REF to sink and source current is often overlooked and can lead to significant errors. Therefore, the MAX4208/MAX4209 include a REFIN buffer, an internal, precision unity-gain buffer on-chip to sink and source the currents needed at REF without loading the reference voltage supplied at REFIN/MODE.

Ultra-Low Offset/Drift, Precision Instrumentation Amplifiers with REF Buffer

Table 1. REFIN/MODE Pin Functions

REFIN/MODE VOLTAGE*	STATE OF MAX4208/MAX4209 and REFIN BUFFER
V_{DD} (typically +5V)	The entire IC is in SHDN mode and draws 1.4 μ A of supply current.
Between $V_{SS} + 200\text{mV}$ and $(V_{DD} - 1.3\text{V})$	The internal REF buffer is activated. REF MUST NOT be fed by any external source. The voltage at REFIN/MODE is transferred to REF within $\pm 40\mu\text{V}$, max (V_{OS} of the internal REF buffer).
V_{SS} (typically ground)	The internal REF buffer is OFF with its output in a high-impedance state to allow direct drive of REF (or connection to ground). REF must be directly connected to an external voltage reference capable of sinking and sourcing the load current.

*See the *Electrical Characteristics* table for detailed specifications.

In a conventional instrumentation amplifier, a simple method to apply a reference voltage is the use of a voltage-divider to set the REF level (often halfway between ground and V_{DD}). The voltage-divider should be made of higher value resistors to minimize current consumption, but the sinking and sourcing current from the load and gain-setting resistors create a significant common-mode signal at the divider midpoint. The MAX4208/MAX4209 precision REFIN buffer essentially eliminates the error voltage at REF.

The REFIN buffer is a unity-gain op amp that has a guaranteed V_{OS} of less than 40 μV with a CMOS input bias current of only 1pA, to allow setting REFIN with a simple resistive divider with minimum errors.

REFIN/MODE is a triple function input (see Table 1). To use the internal REFIN buffer, connect REFIN/MODE to an external reference or a simple resistive divider at any voltage between ($V_{SS} + 0.2\text{V}$) and ($V_{DD} - 1.3\text{V}$). These voltages represent the minimum and maximum for the REFIN buffer's input common-mode range (see the *Electrical Characteristics* table). To use ground at REF or to use an external low-impedance reference directly at REF without the internal REFIN buffer, connect REFIN/MODE to V_{SS} . This disables the REFIN buffer, dropping the I_{DD} to 750 μA and puts the REFIN buffer output in a high-impedance state to allow external direct drive of REF. To put the MAX4208/MAX4209 into shutdown and reduce the supply current to less than 5 μA , drive REFIN/MODE to V_{DD} .

Note: When driving REF directly, REFIN/MODE must be at V_{SS} and shutdown mode is NOT available.

Input Differential Signal Range

The MAX4208/MAX4209 feature a proprietary input structure optimized for small differential signals of up to $\pm 100\text{mV}$. The output of the MAX4208/MAX4209 allows for bipolar input signals. The output voltage is equal to the voltage at REF for zero differential input. The gain accuracy of these devices is laser trimmed to better than 0.1% (typ).

Output Swing

The MAX4208/MAX4209 are designed specifically for small input signals ($\pm 100\text{mV}$) from sensors, strain gauges, etc. These instrumentation amplifiers are capable of rail-to-rail output-voltage swings; however, depending on the selected gain and REF level, the rail-to-rail output swing may not be required or desired.

For example, consider single-supply operation of the MAX4208 in a unity-gain configuration with REF connected to a voltage at half of the supply voltage ($V_{DD} / 2$). In this case, the output-voltage swing would be $\pm 100\text{mV}$ around the REF level and would not need to reach either rail.

Another example is the MAX4209H (gain internally set to 100) also operating with a single-supply voltage and REF set externally to ground (V_{SS}). REFIN/MODE must also be connected to ground (V_{SS}). In this case, an input voltage of 0 to 10mV differential would ideally drive an output-voltage swing of 0 to 1V. However, the output swing can only get to within 40mV of ground (V_{SS}) (see the V_{OL} specifications in the *Electrical Characteristics* table). It is recommended that for best accuracy and linearity, the lowest differential input voltage for unipolar operation is usually picked to be a nonzero value (e.g., 0.5mV or more).

Another remedy is to use REFIN/MODE of 250mV (see the REFIN/MODE Buffered Reference Input Range in the *Electrical Characteristics* table), which causes a 0 to 100mV input to start OUT at 250mV and swing to 1.25V, to prevent the output from going into its bottom nonlinear range. An ADC with differential input can be connected between OUT and REF to record the true 0 to 1V swing.

Devices with higher gain and bipolar output swing can be configured to approach either rail for maximum dynamic range. However, as the output approaches within V_{OL} or V_{OH} of the supply voltages, the linearity and accuracy degrades, especially under heavy loading.

Ultra-Low Offset/Drift, Precision Instrumentation Amplifiers with REF Buffer

Applications Information

Setting the Gain (MAX4208)

Connect a resistive divider from OUT to REF with the center tap connected to FB to set the gain for the MAX4208 (see the *Typical Application Circuit*). Calculate the gain using the following formula:

$$\text{GAIN} = 1 + \left(\frac{R2}{R1} \right)$$

Choose a value for $R1 \leq 1\text{k}\Omega$. Resistor accuracy ratio directly affects gain accuracy. Resistor sum less than $10\text{k}\Omega$ should not be used because their loading can slightly affect output accuracy.

Input Common Mode vs. Input Differential-Voltage Range

Traditional three-op amp instrumentation amplifiers have a defined relationship between the maximum input differential voltage and maximum input common-mode voltage that arises from saturation of intermediate amplifier stages. This correlation is frequently represented as a hexagon graph of input common-mode voltage vs. output voltage for the instrumentation amplifier shown in Figure 3. Application limitations hidden in this graph are:

- The input common-mode voltage range does not include the negative supply rail, and so no amplification is possible for inputs near ground for single-supply applications.
- Input differential voltages can be amplified with maximum gain only over a limited range of input common-mode voltages (i.e., range of y-axis for max range of x-axis is limited).
- If large amplitude common-mode voltages need to be rejected, differential voltages cannot be amplified with a maximum gain possible (i.e., range of x-axis for a maximum range of y-axis is limited). As a consequence, a secondary high-gain amplifier is required to follow the front-end instrumentation amplifier.

The indirect current-feedback architecture of the MAX4208/MAX4209 instrumentation amplifiers do not suffer from any of these drawbacks. Figure 4 shows the input common-mode voltage vs. output voltage graph of indirect current-feedback architecture.

In contrast to three-op amp instrumentation amplifiers, the MAX4208/MAX4209 features:

- The input common-mode voltage range, which includes the negative supply rail and is ideal for single-supply applications.
- Input differential voltages that can be amplified with maximum gain over the entire range of input common-mode voltages.
- Large common-mode voltages that can be rejected at the same time differential voltages are amplified with maximum gain, and therefore, no secondary amplifier is required to follow the front-end instrumentation amplifier.

Gain Error Drift Over Temperature

Adjustable gain instrumentation amplifiers typically use a single external resistor to set the gain. However, due to differences in temperature drift characteristics between the internal and external resistors, this leads to large gain-accuracy drift over temperature. The MAX4208 is an adjustable gain instrumentation amplifier that uses two external resistors to set its gain. Since both resistors are external to the device, layout and temperature coefficient matching of these parts deliver a significantly more stable gain over operating temperatures.

The fixed gain, MAX4209H has both internal resistors for excellent matching and tracking.

Use of External Capacitor C_{FB} for Noise Reduction

Zero-drift chopper amplifiers include circuitry that continuously compensates the input offset voltage to deliver precision and ultra-low temperature drift characteristics. This self-correction circuitry causes a small additional noise contribution at its operating frequency (a pseudo-random clock around 45kHz for MAX4208/MAX4209). For high-bit resolution ADCs, external filtering can significantly attenuate this additional noise. Simply adding a feedback capacitor (C_{FB}) between OUT and FB reduces high-frequency gain, while retaining the excellent precision DC characteristics. Recommended values for C_{FB} are between 1nF and 10nF. Additional anti-aliasing filtering at the output can further reduce this auto-correction noise.

Capacitive-Load Stability

The MAX4208/MAX4209 are capable of driving capacitive loads up to 200pF. Applications needing higher capacitive drive capability may use an isolation resistor between OUT and the load to reduce ringing on the output signal. However, this reduces the gain accuracy due to the voltage drop across the isolation resistor.

Ultra-Low Offset/Drift, Precision Instrumentation Amplifiers with REF Buffer

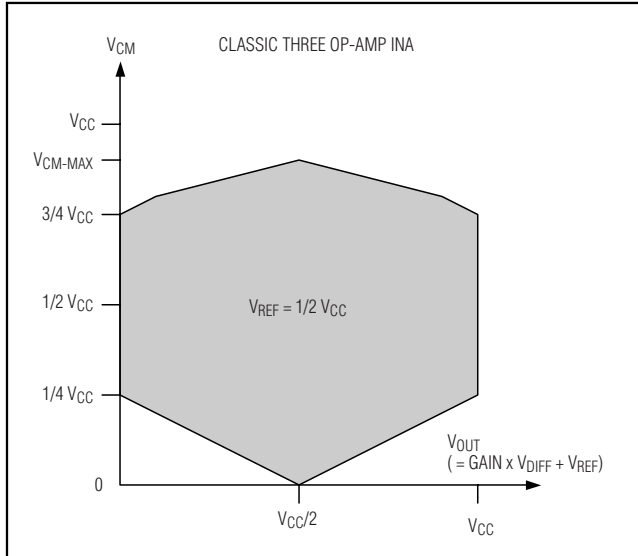

Figure 3. Limited Common Mode vs. Output Voltage of a Three Op-Amp INA

Power-Supply Bypass and Layout

Good layout technique optimizes performance by decreasing the amount of stray capacitance at the instrumentation amplifier's gain-setting pins (OUT, FB, and REF). Excess capacitance produces peaking in the amplifier's frequency response. To decrease stray capacitance, minimize trace lengths by placing external components as close as possible to the instrumentation amplifier. Unshielded long traces at the inputs of the instrumentation amplifier degrade the CMRR and pick-up noise. This produces inaccurate output in high-gain configurations. Use shielded or coax cables to connect the inputs of the instrumentation amplifier. Since the MAX4208/MAX4209 feature ultra-low input offset voltage, board leakage and thermocouple effects can easily introduce errors in the input offset voltage readings when used with high-impedance signal sources. Minimize board leakage current and thermocouple effects by thoroughly cleaning the board and placing the matching components very close to each other and with appropriate orientation. For best performance, bypass each power supply to ground with a separate 0.1 μ F capacitor.

For noisy digital environments, the use of multilayer PCB with separate ground and power-supply planes is recommended. Keep digital signals far away from the sensitive analog inputs.

Refer to the MAX4208 or MAX4209 Evaluation Kit data sheets for good layout examples.

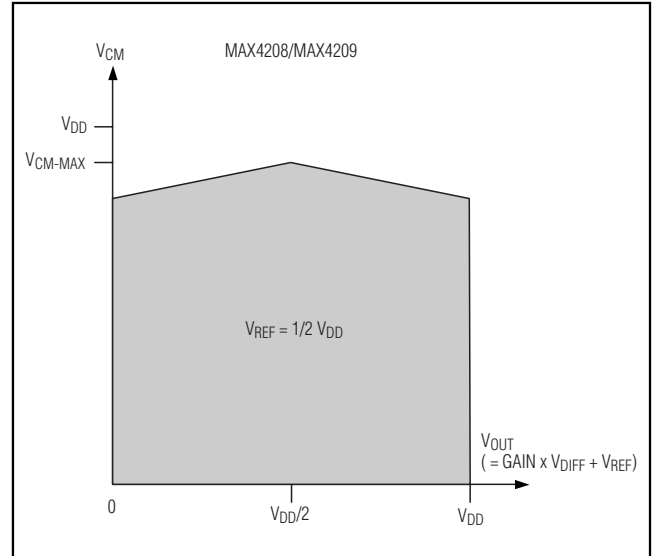

Figure 4. Input Common Mode vs. Output Voltage of MAX4208/MAX4209 Includes 0V (GND)

Low-Side Current-Sense Amplifier

The use of indirect current-feedback architecture makes the MAX4208/MAX4209 ideal for low-side current-sensing applications, i.e., where the current in the circuit ground needs to be measured by means of a small sense resistor. In these situations, the input common-mode voltage is allowed to be at or even slightly below ground ($V_{SS} - 0.1V$).

If the currents to be measured are bidirectional, connect REFIN/MODE to $V_{DD}/2$ to get full dynamic range for each direction. If the currents to be measured are unidirectional, both REFIN/MODE and REF can be tied to GND. However, VOL limitations can limit low-current measurement. If currents need to be measured down to 0A, bias REFIN/MODE to a voltage above 0.2V to activate the internal buffer and to stay above amplifier VOL, and measure both OUT and REF with a differential input ADC.

Low-Voltage, High-Side Current-Sense Amplifier

Power management is a critical area in high-performance portable devices such as notebook computers. Modern digital processors and ASICs are using smaller transistor geometries to increase speed, reduce size, and also lower their operating core voltages (typically 0.9V to 1.25V). The MAX4208/MAX4209 instrumentation amplifiers can be used as a nearly zero voltage-drop, current-sense amplifier (see Figure 5).

Ultra-Low Offset/Drift, Precision Instrumentation Amplifiers with REF Buffer

The ultra-low V_{OS} of the MAX4208/MAX4209 allows full-scale V_{SENSE} of only 10mV to 20mV for minimally invasive current sensing using milliohm sense resistors to get high accuracy. Previous methods used the internal resistance of the inductor in the step-down DC-DC converter to measure the current, but the accuracy was only 20% to 30%. Using a full-scale V_{SENSE} of 20mV, a 20 μ V max, V_{OS} error term is less than 0.1% and

MAX4209H gain error is 0.25% max at 100x, so the total accuracy is greatly improved. The 0 to 2V output of MAX4209H can be sent to an ADC for calculation. The adjustable gain of MAX4208, can be set to a gain of 250x using 1k Ω and 249k Ω resistors, to scale up a lower 10mV V_{SENSE} voltage to a larger 2.5V output voltage for wider dynamic range as needed.

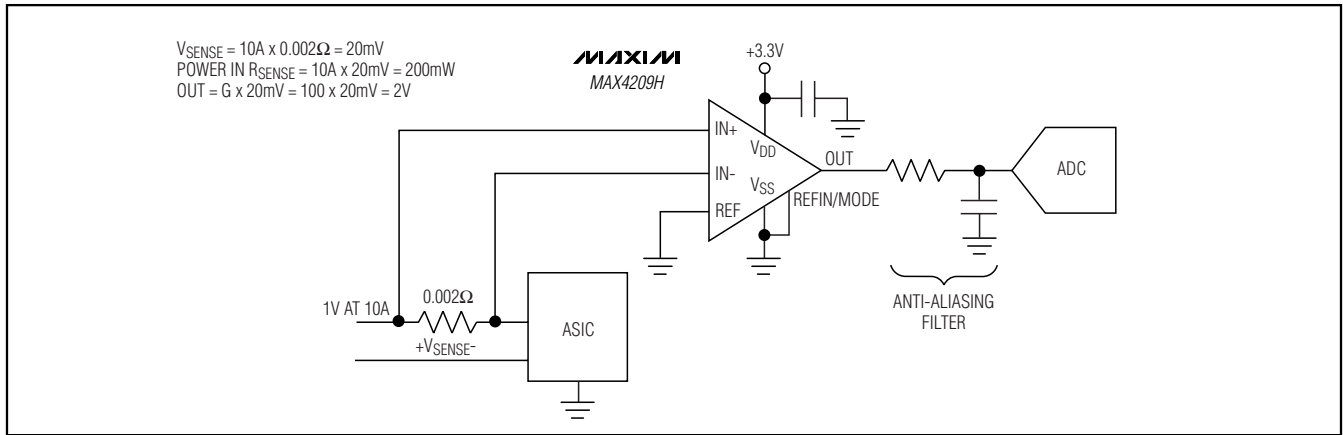
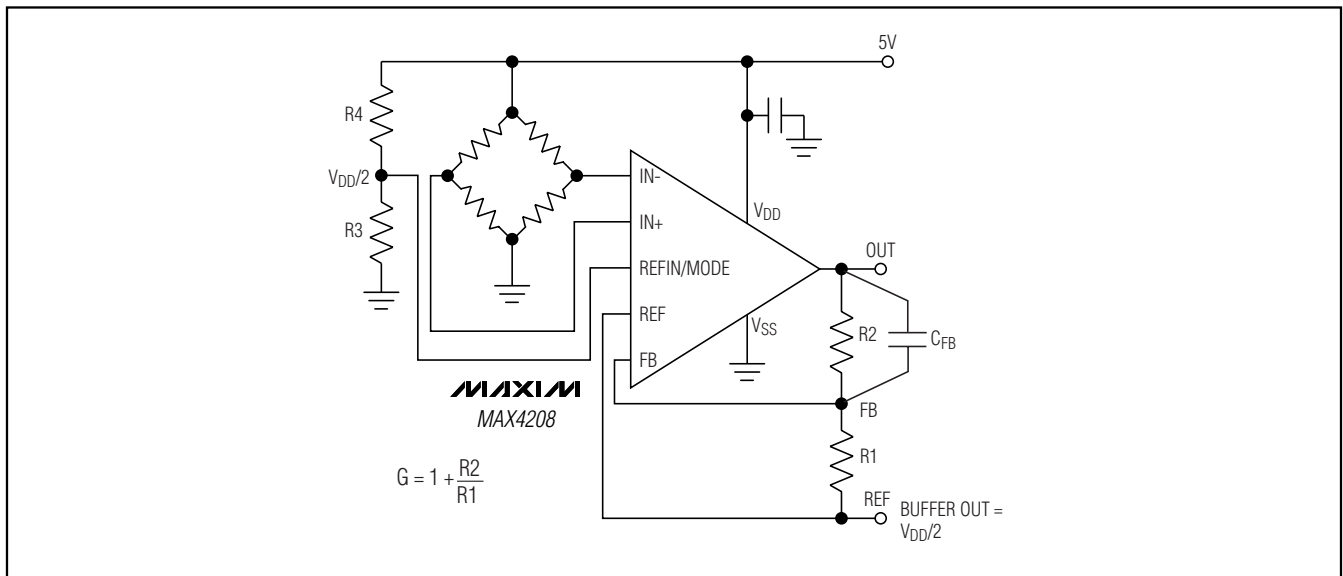

Figure 5. MAX4208/MAX4209 Used as Precision Current-Sense Amplifiers for Notebook Computers with V_{SENSE} of 20mV

Typical Application Circuit



Ultra-Low Offset/Drift, Precision Instrumentation Amplifiers with REF Buffer

Pin Configuration

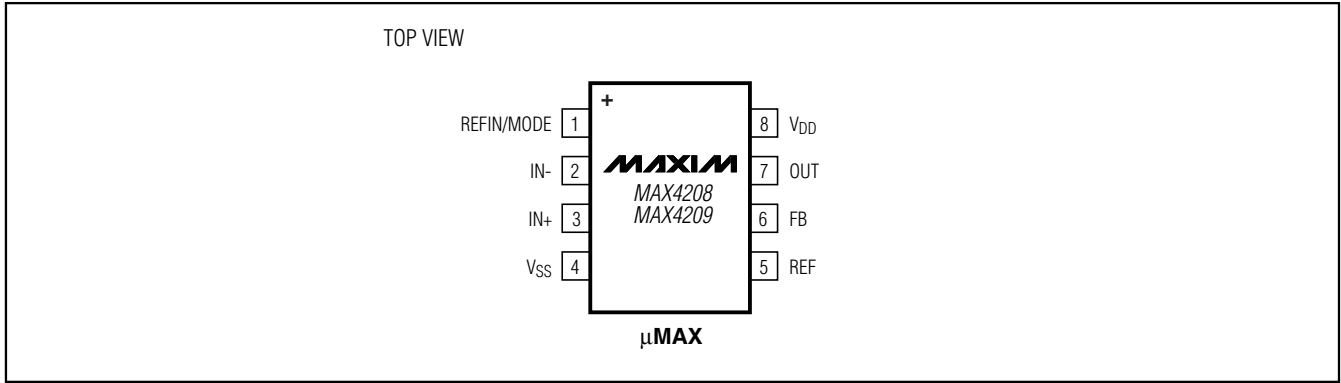

Chip Information

TRANSISTOR COUNT: 2335
PROCESS: BiCMOS

Package Information

For the latest package outline information, go to www.maxim-ic.com/package.

PACKAGE TYPE	PACKAGE CODE	DOCUMENT NO.
8 μMAX	U8-1	21-0036

Ultra-Low Offset/Drift, Precision Instrumentation Amplifiers with REF Buffer

Revision History

REVISION NUMBER	REVISION DATE	DESCRIPTION	PAGES CHANGED
0	9/07	Initial release	—
1	4/09	Removed future products	1-5, 11, 12, 13

MAX4208/MAX4209

Maxim cannot assume responsibility for use of any circuitry other than circuitry entirely embodied in a Maxim product. No circuit patent licenses are implied. Maxim reserves the right to change the circuitry and specifications without notice at any time.

Maxim Integrated Products, 120 San Gabriel Drive, Sunnyvale, CA 94086 408-737-7600 _____ 17

© 2009 Maxim Integrated Products

Maxim is a registered trademark of Maxim Integrated Products, Inc.