

EVALUATION KIT
AVAILABLE

Single/Dual SC70, Zero-Drift, High-Efficiency, 1.5MHz Op Amps with RRIO

General Description

The MAX9617–MAX9620 are low-power, zero-drift operational amplifiers available in space-saving SC70 packages. They are designed for use in portable consumer, medical, and industrial applications.

The MAX9617–MAX9620 feature rail-to-rail CMOS inputs and outputs, a 1.5MHz GBW at just 59µA supply current and 10µV (max) zero-drift input offset voltage over time and temperature. The zero-drift feature reduces the high 1/f noise typically found in CMOS input operational amplifiers, making it useful for a wide variety of low-frequency measurement applications.

The MAX9617 and MAX9619 are available in a space-saving, 2mm x 2mm, 6-pin SC70 package. The MAX9619 features a power-saving shutdown mode. The MAX9618 is available in a 2mm x 2mm, 8-pin SC70 package. The MAX9620 is available in a 2mm x 2mm, 5-pin SC70 package. All devices are specified over the -40°C to +125°C automotive operating temperature range.

Applications

Sensor Interfaces
Loop-Powered Systems
Portable Medical Devices
Battery-Powered Devices
Cardiac Monitors

Features

- ◆ Low 59µA Quiescent Current
- ◆ Very-Low 10µV (max) Input Offset Voltage
- ◆ Dual Version Available in an 8-Pin SC70 Package
- ◆ Low Input Noise
42nV/√Hz at 1kHz
0.42µVp-p from 0.1Hz to 10Hz
- ◆ Rail-to-Rail Inputs and Outputs
- ◆ 1.5MHz GBW
- ◆ Ultra-Low 10pA Input Bias Current
- ◆ Single 1.8V to 5.5V Supply Voltage Range
- ◆ Unity-Gain Stable
- ◆ Power-Saving Shutdown Mode (MAX9619)
- ◆ Available in Tiny 5-Pin SC70 (MAX9620), 6-Pin SC70 (MAX9617/MAX9619), and 8-Pin SC70 (MAX9618) Packages

Ordering Information

PART	TEMP RANGE	PIN-PACKAGE
MAX9617AXT+	-40°C to +125°C	6 SC70
MAX9618AXA+	-40°C to +125°C	8 SC70
MAX9619AXT+	-40°C to +125°C	6 SC70
MAX9620AXK+	-40°C to +125°C	5 SC70

+ Denotes a lead(Pb)-free/RoHS-compliant package.

Functional Diagrams

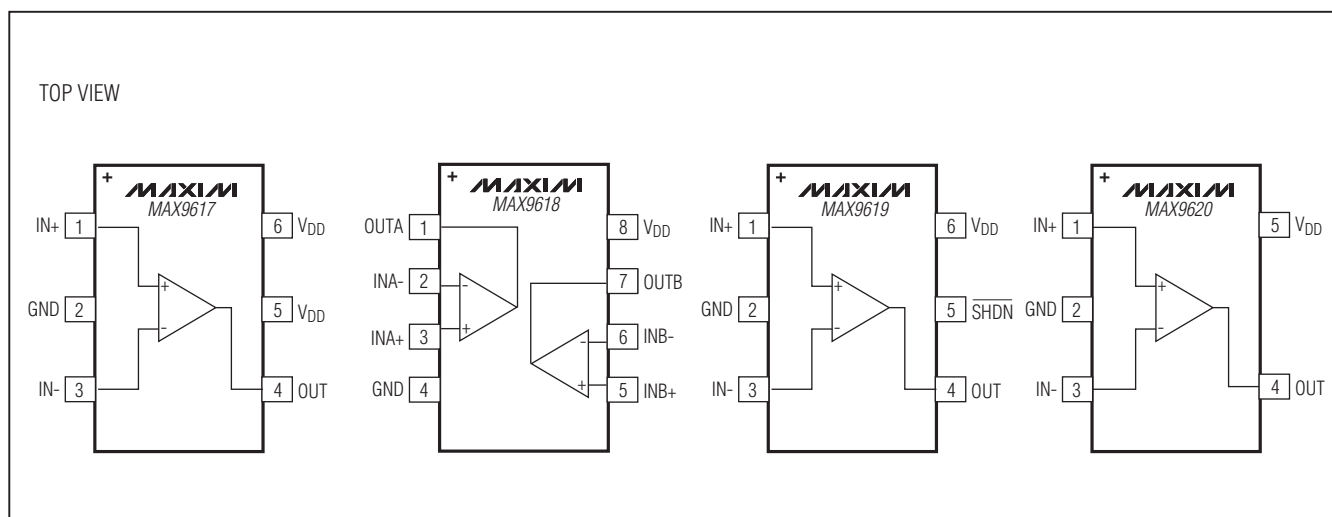

Maxim Integrated Products 1

For pricing, delivery, and ordering information, please contact Maxim Direct at 1-888-629-4642, or visit Maxim's website at www.maxim-ic.com.

Single/Dual SC70, Zero-Drift, High-Efficiency, 1.5MHz Op Amps with RRIO

ABSOLUTE MAXIMUM RATINGS

Supply Voltage (VDD to GND).....	-0.3V to +6V	6-Pin SC70 (derate 3.1mW/°C above +70°C).....	245.4mW
All Other Pins, IN+ to IN-	(V _{GND} - 0.3V) to (V _{DD} + 0.3V)	8-Pin SC70 (derate 3.1mW/°C above +70°C).....	245mW
Short-Circuit Duration to Either Supply Rail, OUT, OUTA, OUTB.....	10s	Operating Temperature Range	-40°C to +125°C
Continuous Input Current (any pins).....	±20mA	Junction Temperature	+150°C
Continuous Power Dissipation (T _A = +70°C)		Storage Temperature Range.....	-65°C to +150°C
5-Pin SC70 (derate 3.1mW/°C above +70°C).....	247mW	Lead Temperature (soldering, 10s)	+300°C
		Soldering Temperature (reflow)	+260°C

Stresses beyond those listed under "Absolute Maximum Ratings" may cause permanent damage to the device. These are stress ratings only, and functional operation of the device at these or any other conditions beyond those indicated in the operational sections of the specifications is not implied. Exposure to absolute maximum rating conditions for extended periods may affect device reliability.

ELECTRICAL CHARACTERISTICS

(V_{DD} = +3.3V, V_{GND} = 0V, V_{IN+} = V_{IN-} = V_{DD}/2, R_L = 100kΩ to V_{DD}/2, T_A = -40°C to +125°C, unless otherwise noted. Typical values are at +25°C.) (Note 1)

PARAMETER	SYMBOL	CONDITIONS	MIN	TYP	MAX	UNITS
POWER SUPPLY						
Supply Voltage Range	V _{DD}	Guaranteed by PSRR, 0°C ≤ T _A ≤ +70°C	1.6		5.5	V
		Guaranteed by PSRR, -40°C ≤ T _A ≤ +125°C	1.8		5.5	
Supply Current (per Amplifier)	I _{DD}	T _A = +25°C		59	78	μA
		-40°C ≤ T _A ≤ +125°C			111	
Power-Supply Rejection Ratio (Note 2)	PSRR	V _{DD} = 1.8V to 5.5V	T _A = +25°C	119	135	dB
			-40°C ≤ T _A ≤ +125°C	107		
		0°C ≤ T _A ≤ +70°C, V _{DD} = 1.6V to 5.5V		116	135	
Power-Up Time	t _{ON}	V _{DD} = 0V to 3V step, A _v = 1V/V		20		μs
Shutdown Supply Current	I _{SHDN}	MAX9619 only			300	nA
Turn-On Time from Shutdown (MAX9619)	t _{OSD}	V _{DD} = 3.3V, V _{SHDN} = 0V to 3.3V step		50		μs
DC SPECIFICATIONS						
Input Offset Voltage (Note 2)	V _{OS}	T _A = +25°C		0.8	10	μV
		-40°C ≤ T _A ≤ +125°C			25	
Input Offset Voltage Drift (Note 2)	ΔV _{OS}			5	120	nV/°C
Input Bias Current (Note 2)	I _B	T _A = +25°C		31	80	pA
		-40°C ≤ T _A ≤ +85°C			95	
		-40°C ≤ T _A ≤ +125°C			580	
Input Offset Current	I _{OS}			5		pA
Input Common-Mode Range	V _{CM}	Guaranteed by CMRR test	T _A = +25°C	-0.1	V _{DD} + 0.1	V
			-40°C ≤ T _A ≤ +125°C	-0.1	V _{DD} + 0.05	
Common-Mode Rejection Ratio (Note 2)	CMRR	-0.1V ≤ V _{CM} ≤ V _{DD} + 0.1V, T _A = +25°C		122	135	dB
		-0.1V ≤ V _{CM} ≤ V _{DD} + 0.05V, -40°C ≤ T _A ≤ +125°C		116		
Open-Loop Gain (Note 2)	A _{VOL}	20mV ≤ V _{OUT} ≤ V _{DD} - 20mV, R _L = 100kΩ to V _{DD} /2		120	138	dB
		150mV ≤ V _{OUT} ≤ V _{DD} - 150mV, R _L = 5kΩ to V _{DD} /2		123	160	

Single/Dual SC70, Zero-Drift, High-Efficiency, 1.5MHz Op Amps with RRIO

ELECTRICAL CHARACTERISTICS (continued)

(V_{DD} = +3.3V, V_{GN}D = 0V, V_{IN+} = V_{IN-} = V_{DD}/2, R_L = 100kΩ to V_{DD}/2, T_A = -40°C to +125°C, unless otherwise noted. Typical values are at +25°C.) (Note 1)

PARAMETER	SYMBOL	CONDITIONS		MIN	TYP	MAX	UNITS
Input Resistance	R _{IN}	Differential					MΩ
		Common mode		50			
Output-Voltage Swing	V _{OH}	V _{DD} - V _{OUT}	R _L = 100kΩ to V _{DD} /2			12	mV
			R _L = 5kΩ to V _{DD} /2			22	
			R _L = 600Ω to V _{DD} /2			50	
	V _{OL}	V _{OUT}	R _L = 100kΩ to V _{DD} /2			11	
			R _L = 5kΩ to V _{DD} /2			18	
			R _L = 600Ω to V _{DD} /2			50	
Short-Circuit Current	I _{SC}					150	mA
AC SPECIFICATIONS							
Gain-Bandwidth Product	GBWP					1.5	MHz
Slew Rate	SR	0V ≤ V _{OUT} ≤ 2V				0.7	V/μs
Input Voltage-Noise Density	e _n	f = 1kHz				42	nV/√Hz
Input Voltage Noise		0.1Hz ≤ f ≤ 10Hz				0.42	μV _{P-P}
Input Current-Noise Density	i _n	f = 1kHz				100	fA/√Hz
Phase Margin		C _L = 20pF				60	Degrees
Capacitive Loading	C _L	No sustained oscillation, A _V = 1V/V				400	pF
Crosstalk		f = 10kHz (MAX9618)				-100	dB
LOGIC INPUT (MAX9619)							
Shutdown Input Low	V _{IL}					0.5	V
Shutdown Input High	V _{IH}			1.3			V
Shutdown Input Leakage Current	I _{IL} /I _{IH}			1		100	nA

Note 1: Specifications are 100% tested at T_A = +25°C (exceptions noted). All temperature limits are guaranteed by design.

Note 2: Guaranteed by design.

Typical Operating Characteristics

(V_{DD} = +3.3V, V_{GN}D = 0V, outputs have R_L = 100kΩ connected to V_{DD}/2. T_A = +25°C, unless otherwise specified.)

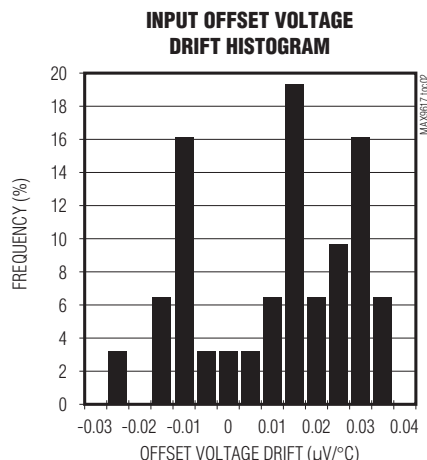
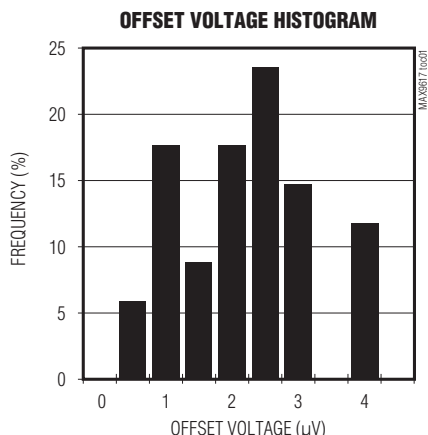

Single/Dual SC70, Zero-Drift, High-Efficiency, 1.5MHz Op Amps with RRIO

Typical Operating Characteristics (continued)

($V_{DD} = +3.3V$, $V_{GND} = 0V$, outputs have $R_L = 100k\Omega$ connected to $V_{DD}/2$. $T_A = +25^\circ C$, unless otherwise specified.)

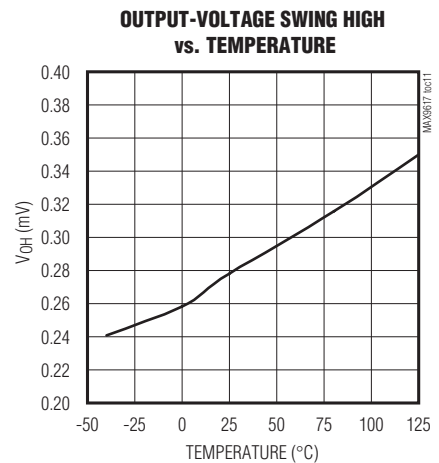
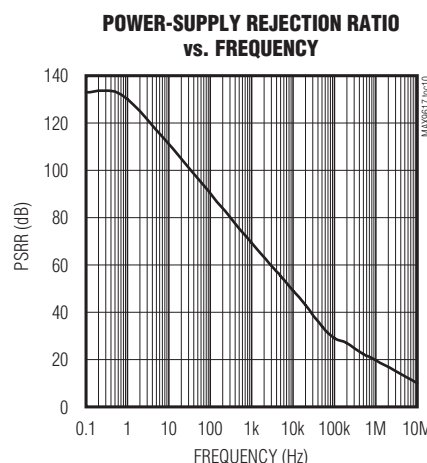
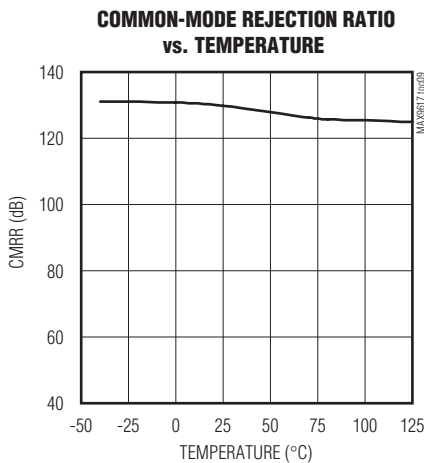
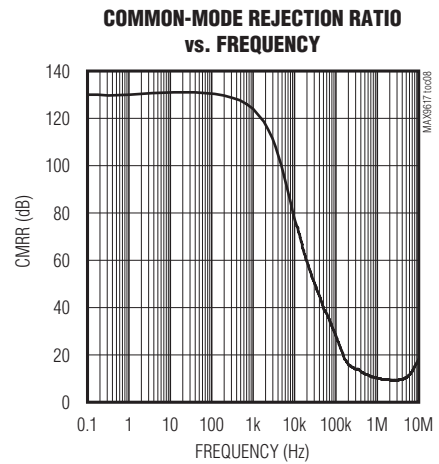
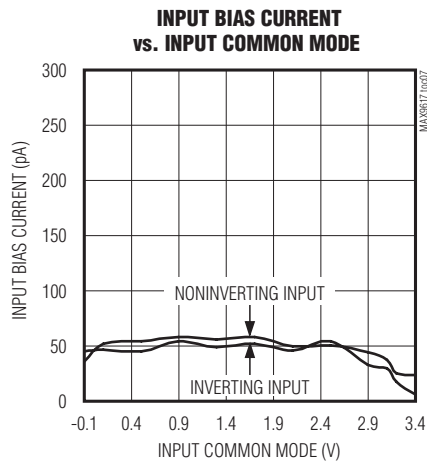
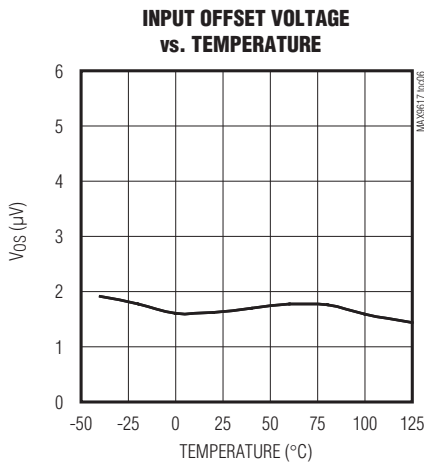
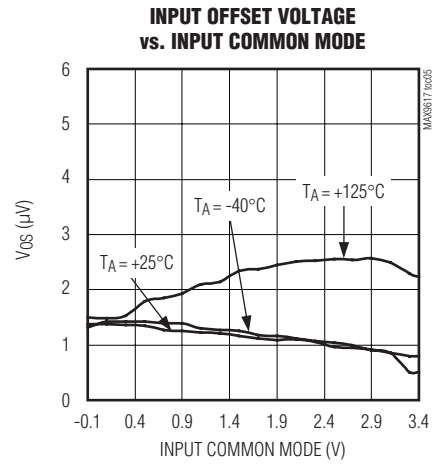
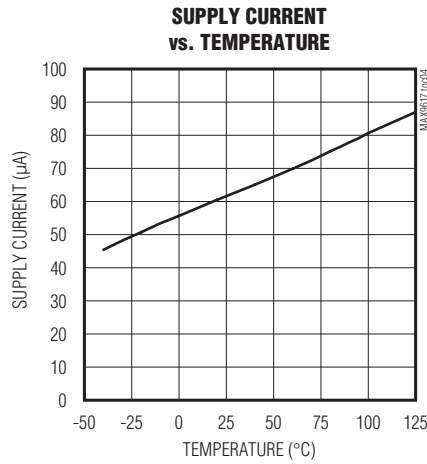
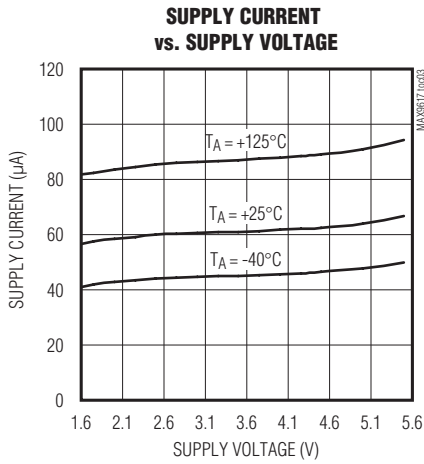

Single/Dual SC70, Zero-Drift, High-Efficiency, 1.5MHz Op Amps with RRIO

Typical Operating Characteristics (continued)

($V_{DD} = +3.3V$, $V_{GND} = 0V$, outputs have $R_L = 100k\Omega$ connected to $V_{DD}/2$. $T_A = +25^\circ C$, unless otherwise specified.)

MAX9617-MAX9620

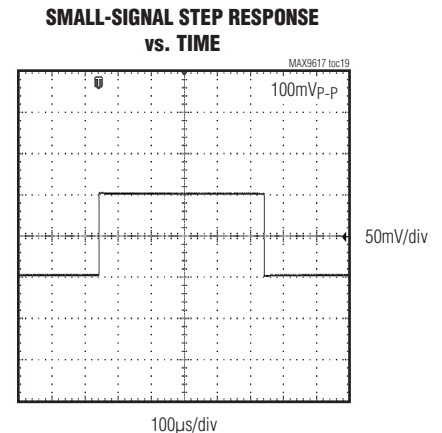
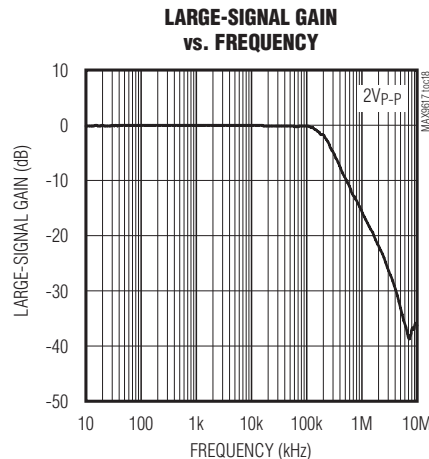
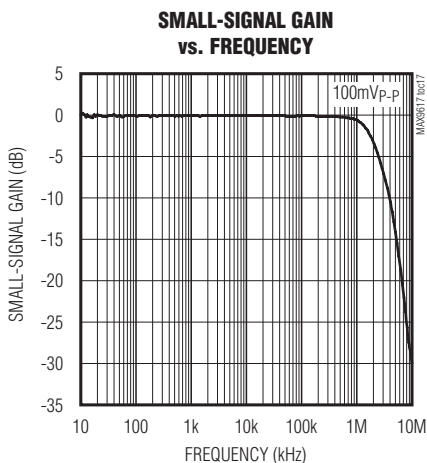
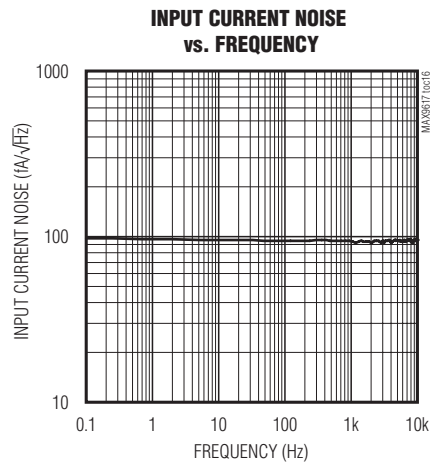
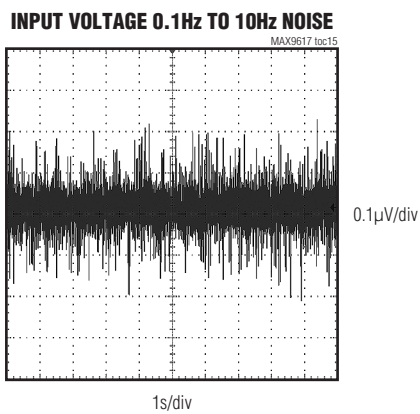
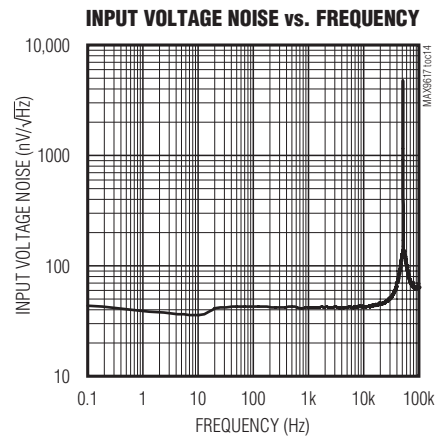
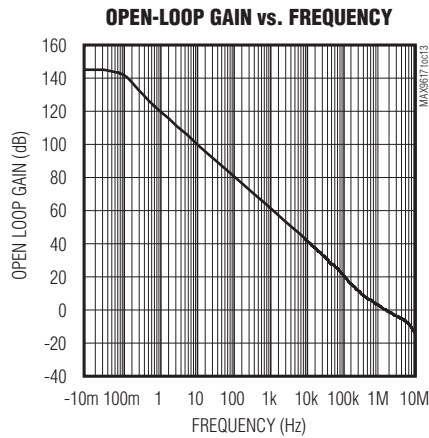
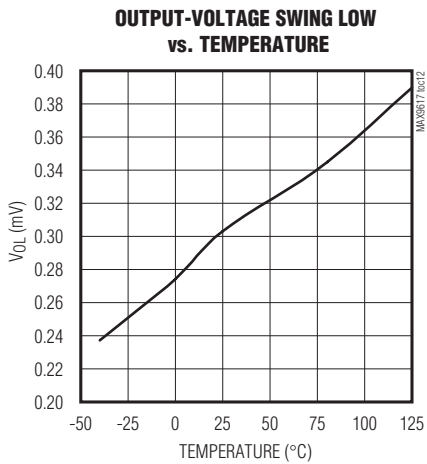

Single/Dual SC70, Zero-Drift, High-Efficiency, 1.5MHz Op Amps with RRIO

Typical Operating Characteristics (continued)

(V_{DD} = +3.3V, V_{GND} = 0V, outputs have R_L = 100kΩ connected to V_{DD}/2. T_A = +25°C, unless otherwise specified.)

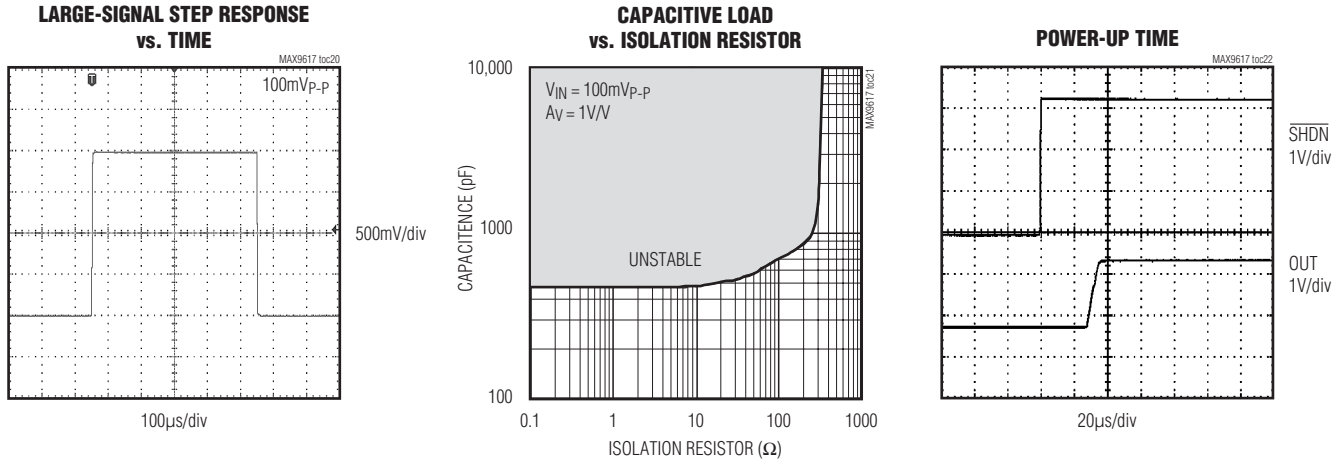

Pin Configurations

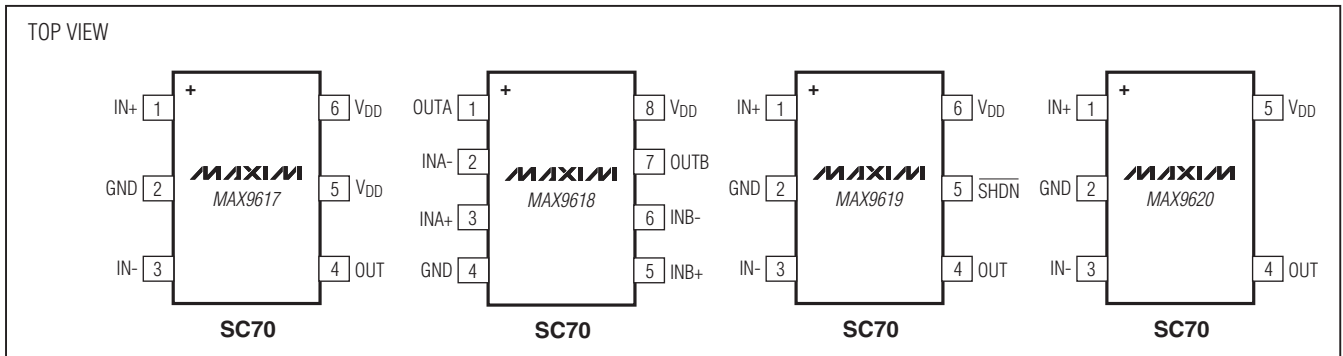

Pin Description

PIN				NAME	FUNCTION
MAX9617	MAX9618	MAX9619	MAX9620		
1	—	1	1	IN+	Positive Input
2	4	2	2	GND	Ground
3	—	3	3	IN-	Negative Input
4	—	4	4	OUT	Output
5, 6	8	6	5	V _{DD}	Positive Supply Voltage. Bypass to GND with a 0.1μF capacitor.
—	—	5	—	SHDN	Shutdown. Pull shutdown low to activate shutdown mode.
—	1	—	—	OUTA	Channel A Output
—	2	—	—	INA-	Channel A Negative Input
—	3	—	—	INA+	Channel A Positive Input
—	5	—	—	INB+	Channel B Positive Input
—	6	—	—	INB-	Channel B Negative Input
—	7	—	—	OUTB	Channel B Output

Single/Dual SC70, Zero-Drift, High-Efficiency, 1.5MHz Op Amps with RRIO

Detailed Description

The MAX9617–MAX9620 are precision, low-power op amps ideal for signal processing applications. The MAX9617, MAX9619, and MAX9620 are single-channel devices. The MAX9618 is a dual-channel device. These devices use an innovative autozero technique that allows precision and low noise with a minimum amount of power. The low input offset voltage, CMOS inputs, and the absence of 1/f noise allows for optimization of active filter designs.

The MAX9617–MAX9620 achieve rail-to-rail performance at the input through the use of a low-noise charge pump. This ensures a glitch-free, common-mode input voltage range extending from the negative supply rail up to the positive supply rail, eliminating crossover distortion common to traditional n-channel/p-channel CMOS pair inputs, reducing harmonic distortion at the output.

The MAX9619 features a shutdown mode that greatly reduces quiescent current when the device is not operational.

Autozero

The MAX9617–MAX9620 feature an autozero circuit that allows the device to achieve less than 10 μ V (max) of input offset voltage and eliminates the 1/f noise.

Internal Charge Pump

An internal charge pump provides an internal supply typically 1V beyond the upper rail. This internal rail allows the MAX9617–MAX9620 to achieve true rail-to-rail inputs and outputs, while providing excellent common-mode rejection, power-supply rejection ratios, and gain linearity.

The charge pump requires no external components, and in most applications is entirely transparent to the user. The operating frequency is well beyond the unity-gain

frequency of the amplifier, avoiding aliasing or other signal integrity issues in sensitive applications.

Shutdown Operation

The MAX9619 features an active-low shutdown mode that lowers the quiescent current to less than 300nA. In shutdown mode, the inputs and output are high impedance. This allows multiple devices to be multiplexed onto a single line without the use of external buffers. Pull $\overline{\text{SHDN}}$ high for normal operation.

The shutdown high (V_{IH}) and low (V_{IL}) threshold voltages are designed for ease of integration with digital controls like microcontroller outputs. These thresholds are independent of supply, eliminating the need for external pulldown circuitry.

Applications Information

The MAX9617–MAX9620 low-power, low-noise, and precision operational amplifiers are designed for applications in the portable medical, such as ECG and pulse oximetry, portable consumer, and industrial markets.

The MAX9617–MAX9620 are also ideal for loop-powered systems that interface with pressure sensors or strain gauges.

Capacitive-Load Stability

Driving large capacitive loads can cause instability in many op amps. The MAX9617–MAX9620 are stable with capacitive loads up to 400pF. Stability with higher capacitive loads can be improved by adding an isolation resistor in series with the op-amp output. This resistor improves the circuit's phase margin by isolating the load capacitor from the amplifier's output. The graph in the *Typical Operating Characteristics* gives the stable operation region for capacitive load versus isolation resistors.

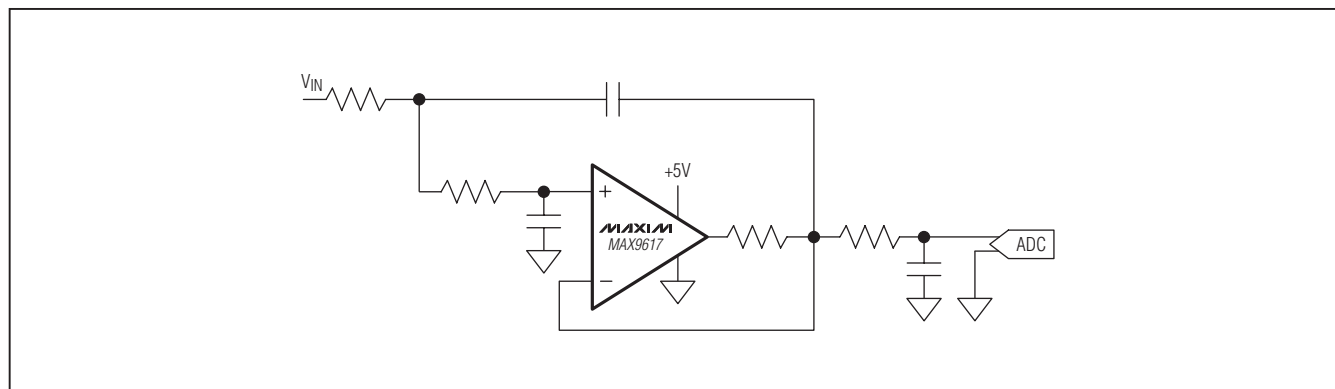

Figure 1. Typical Application Circuit: Sallen-Key Active Lowpass Filter

Single/Dual SC70, Zero-Drift, High-Efficiency, 1.5MHz Op Amps with RRIO

Power Supplies and Layout

The MAX9617-MAX9620 operate either with a single supply from +1.6V to +5.5V with respect to ground or with dual supplies from $\pm 0.8\text{V}$ to $\pm 2.75\text{V}$. When used with dual supplies, bypass both supplies with their own $0.1\mu\text{F}$ capacitor to ground. When used with a single supply, bypass V_{DD} with a $0.1\mu\text{F}$ capacitor to ground.

Careful layout technique helps optimize performance by decreasing the amount of stray capacitance at the op amp's inputs and outputs. To decrease stray capacitance, minimize trace lengths by placing external components close to the op amp's pins.

Chip Information

PROCESS: BiCMOS

Single/Dual SC70, Zero-Drift, High-Efficiency, 1.5MHz Op Amps with RRIO

Package Information

For the latest package outline information and land patterns (footprints), go to www.maxim-ic.com/packages. Note that a "+", "#", or "-" in the package code indicates RoHS status only. Package drawings may show a different suffix character, but the drawing pertains to the package regardless of RoHS status.

PACKAGE TYPE	PACKAGE CODE	OUTLINE NO.	LAND PATTERN NO.
5 SC70	X5+1	21-0076	90-0188
6 SC70	X6SN+1	21-0077	90-0189
8 SC70	X8C+1	21-0460	90-0348

MAX9617-MAX9620

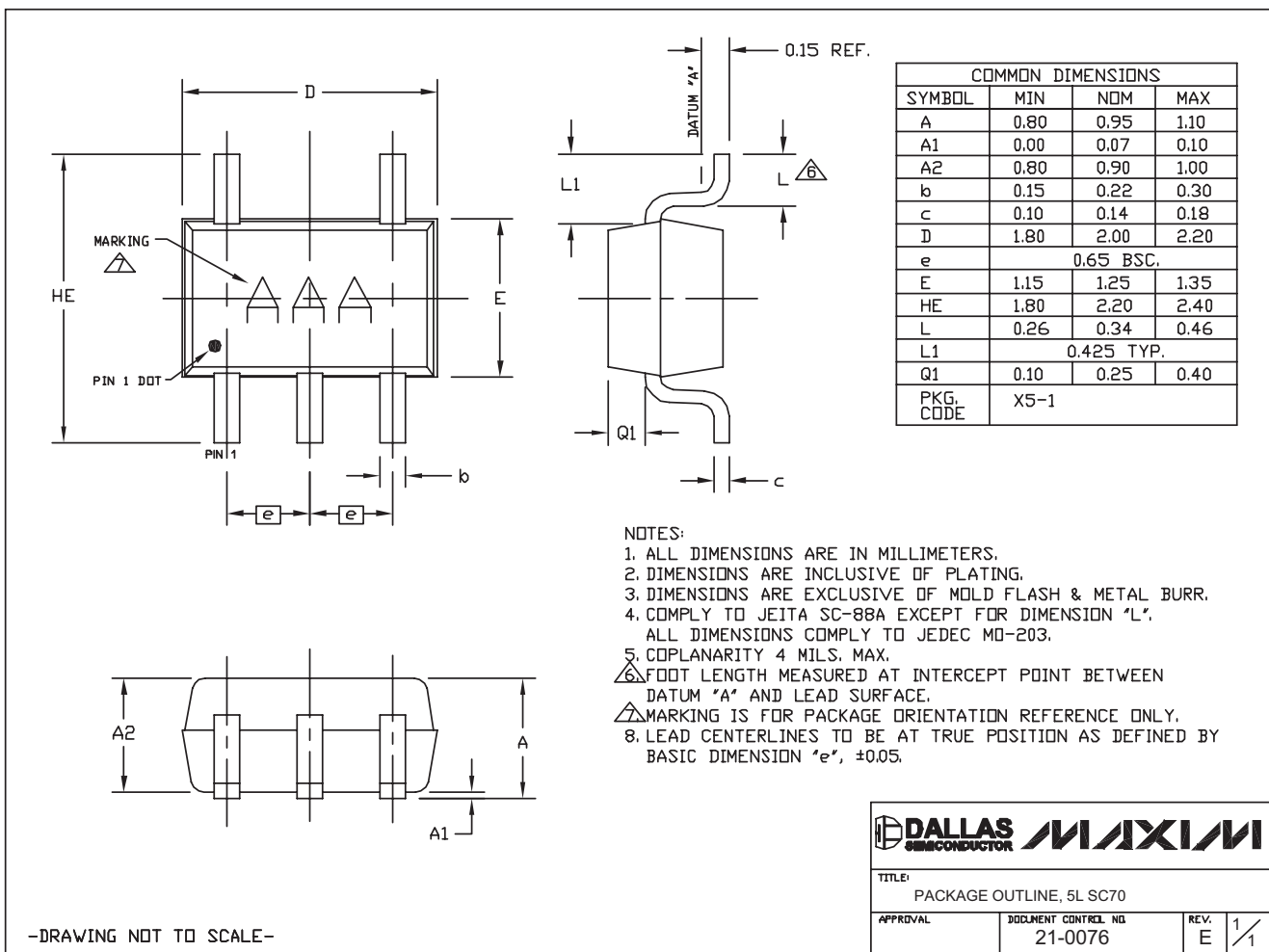

SC70, 5LEPS

Single/Dual SC70, Zero-Drift, High-Efficiency, 1.5MHz Op Amps with RRIO

Package Information (continued)

For the latest package outline information and land patterns (footprints), go to www.maxim-ic.com/packages. Note that a "+", "#", or "-" in the package code indicates RoHS status only. Package drawings may show a different suffix character, but the drawing pertains to the package regardless of RoHS status.

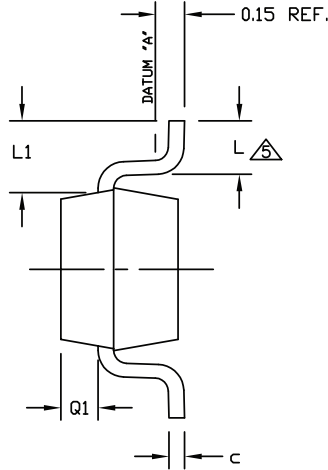
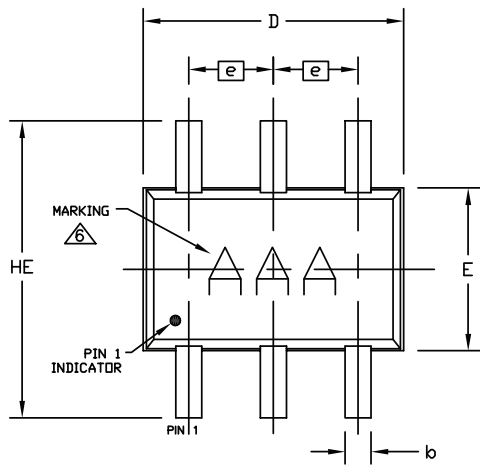

COMMON DIMENSIONS			
SYMBOL	MIN	NOM	MAX
A	0.80	0.95	1.10
A1	0.00	0.07	0.10
A2	0.80	0.90	1.00
b	0.15	0.22	0.30
c	0.10	0.14	0.18
D	1.85	2.00	2.15
e	0.65 BSC.		
E	1.15	1.25	1.35
HE	2.00	2.20	2.35
L	0.26	0.34	0.46
L1	0.425 TYP.		
Q1	0.10	0.25	0.40
PKG. CODES	X6SN-1		

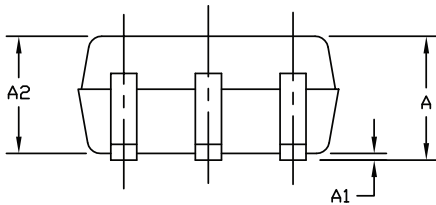

NOTES:

1. ALL DIMENSIONS ARE IN MILLIMETERS.
2. DIMENSIONS ARE INCLUSIVE OF PLATING.
3. DIMENSIONS ARE EXCLUSIVE OF MOLD FLASH & METAL BURR.
4. COPLANARITY 4 MILS. MAX.
5. FOOT LENGTH MEASURED AT INTERCEPT POINT BETWEEN DATUM 'A' AND LEAD SURFACE.
6. MARKING IS FOR PACKAGE ORIENTATION REFERENCE ONLY.
7. LEAD CENTERLINES TO BE AT TRUE POSITION AS DEFINED BY BASIC DIMENSION 'e', ±0.05.
8. ALL DIMENSIONS COMPLY TO JEDEC MO-203.
9. ALL DIMENSIONS APPLY TO BOTH LEADED (-) AND LEAD FREE (+) PACKAGE CODES.

-DRAWING NOT TO SCALE-

MAXIM		
TITLE: PACKAGE OUTLINE, 6L SC70		
APPROVAL	DOCUMENT CONTROL NO. 21-0077	REV. H 1/1

Single/Dual SC70, Zero-Drift, High-Efficiency, 1.5MHz Op Amps with RRIO

Package Information (continued)

For the latest package outline information and land patterns (footprints), go to www.maxim-ic.com/packages. Note that a "+", "#", or "-" in the package code indicates RoHS status only. Package drawings may show a different suffix character, but the drawing pertains to the package regardless of RoHS status.

MAX9617-MAX9620

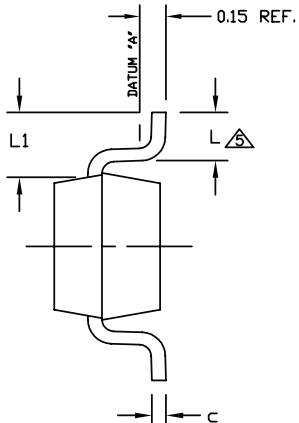
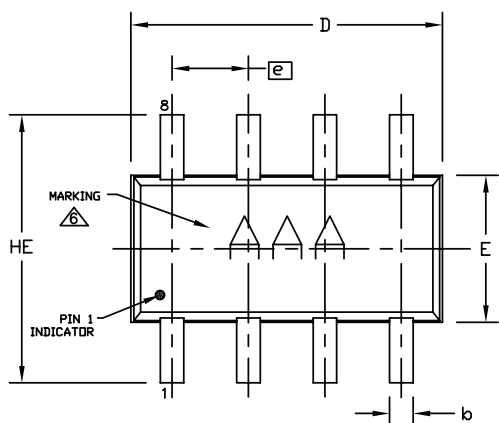

COMMON DIMENSIONS			
SYMBOL	MIN	NOM	MAX
A	0.80	0.95	1.10
A1	0.00	0.07	0.10
A2	0.80	0.90	1.00
A3	0.40	0.47	0.55
b	0.15	0.21	0.27
c	0.10	0.14	0.18
D	1.80	2.00	2.20
e	0.50 BSC.		
E	1.15	1.25	1.35
HE	1.80	2.20	2.40
L	0.26	0.34	0.46
L1	0.425 TYP.		
PKG. CODE	X8CN-1		

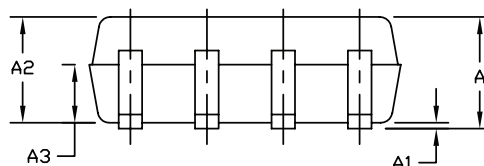

NOTES:

1. ALL DIMENSIONS ARE IN MILLIMETERS.
2. DIMENSIONS ARE INCLUSIVE OF PLATING.
3. DIMENSIONS ARE EXCLUSIVE OF MOLD FLASH & METAL BURR.
4. COPLANARITY 4 MILS. MAX.
5. FOOT LENGTH MEASURED AT INTERCEPT POINT BETWEEN DATUM 'A' AND LEAD SURFACE.
6. MARKING IS FOR PACKAGE ORIENTATION REFERENCE ONLY.
7. LEAD CENTERLINES TO BE AT TRUE POSITION AS DEFINED BY BASIC DIMENSION 'e', ±0.05.
8. ALL DIMENSIONS COMPLY TO JEDEC MO-203.
9. ALL DIMENSIONS APPLY TO BOTH LEADED (-) AND LEAD FREE (+) PACKAGE CODES.

-DRAWING NOT TO SCALE-

MAXIM		
TITLE: PACKAGE OUTLINE, 8L SC70, CDL PKG., NiPd		
APPROVAL	DOCUMENT CONTROL NO. 21-0460	REV. B 1/1

Single/Dual SC70, Zero-Drift, High-Efficiency, 1.5MHz Op Amps with RRIO

Revision History

REVISION NUMBER	REVISION DATE	DESCRIPTION	PAGES CHANGED
0	7/09	Initial release	—
1	9/09	Removed references to MAX9617 shutdown functionality	1, 2, 3, 6, 7
2	2/10	Removed future product reference for the MAX9618, and added MAX9619 and MAX9620 to the data sheet	1-11
3	6/10	Corrected <i>General Description</i> to show that only the MAX9619 has shutdown, corrected the MAX9617 Pin Configuration, and added soldering temperature	1, 2, 12
4	2/11	Updated bias current specifications	2

Maxim cannot assume responsibility for use of any circuitry other than circuitry entirely embodied in a Maxim product. No circuit patent licenses are implied. Maxim reserves the right to change the circuitry and specifications without notice at any time.

12 _____ **Maxim Integrated Products, 120 San Gabriel Drive, Sunnyvale, CA 94086 408-737-7600**

© 2011 Maxim Integrated Products

Maxim is a registered trademark of Maxim Integrated Products, Inc.