

LMP8100

Programmable Gain Amplifier

General Description

The LMP8100 programmable gain amplifier features an adjustable gain from 1 to 16 V/V in 1 V/V increments. At the core of the LMP8100 is a precision, 33 MHz, CMOS input, rail-to-rail input/output operational amplifier with a typical open-loop gain of 110 dB. Amplifier closed-loop gain is set by an array of precision thin-film resistors. Amplifier control modes are programmed via a serial port that allows devices to be cascaded so that an array of LMP8100 amplifiers can be programmed by a single serial data stream. The control mode registers are double buffered to insure glitch-free transitions between programmed settings. The LMP8100 is part of the LMP® precision amplifier family and is ideal for a variety of applications.

The amplifier features several programmable controls including: gain; a power-conserving shutdown mode which can reduce current consumption to only 20 μ A; an input zeroing switch which allows the output offset voltage to be measured to facilitate system calibration; and four levels of internal frequency compensation which can be set to maximize bandwidth at the different gain settings.

The LMP8100 comes in a 14-Pin SOIC package.

Features

Typical Values, $T_A = 25^\circ\text{C}$

- Gain error (over temperature range)
 - LMP8100A 0.03%
 - LMP8100 0.075%
- Gain range 1 to 16 V/V in 1 V/V steps
- Programmable frequency compensation
- Input zero calibration switch
- Input offset voltage (max, LMP8100A) 250 μ V
- Input bias current 0.1 pA
- Input noise voltage 12 nV/ $\sqrt{\text{Hz}}$
- Unity gain bandwidth 33 MHz
- Slew rate 12 V/ μ s
- Output current 20 mA
- Supply voltage range 2.7V to 5.5V
- Supply current 5.3 mA
- Rail-to-Rail output swing $V^+ - 50 \text{ mV}$ to $V^- + 50 \text{ mV}$

Applications

- Industrial instrumentation
- Data acquisition systems
- Test equipment
- Scaling amplifier
- Gain control
- Sensor interface

Simplified Block Diagram

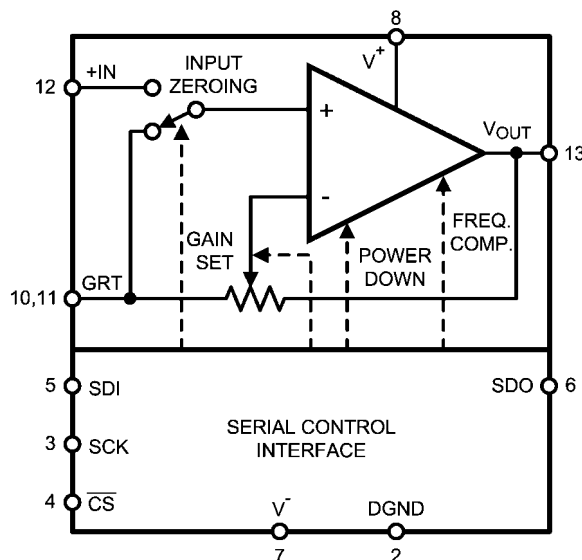

20147607

LMP® is a registered trademark of National Semiconductor Corporation.

Block Diagram

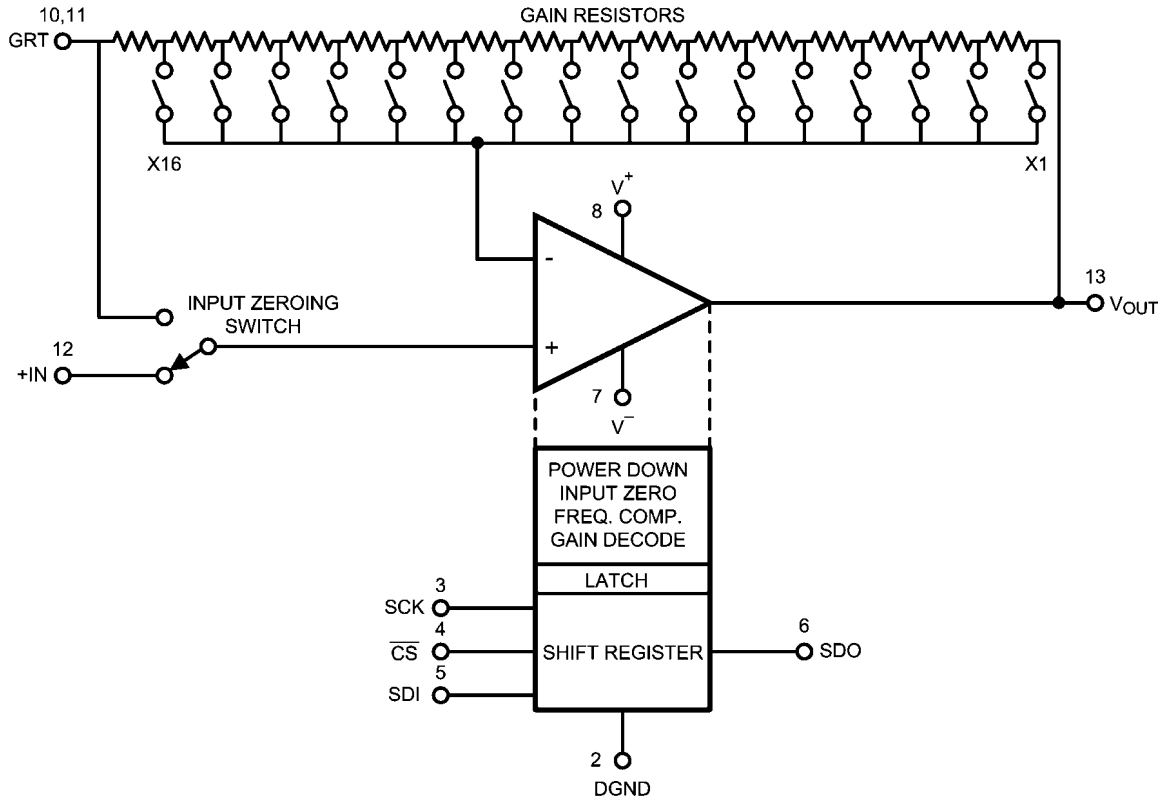

20147602

Absolute Maximum Ratings (Note 1)

If Military/Aerospace specified devices are required, please contact the National Semiconductor Sales Office/Distributors for availability and specifications.

ESD Tolerance (Note 2)	
Human Body Model	2 kV
Machine Model	200V
V_{IN} Differential	2.5V
Output Short Circuit Duration (Note 3)	
Supply Voltage ($V_S = V^+ - V^-$)	6V
Voltage at Input and Output Pins	$V^+ +0.3V, V^- -0.3V$
Input Current	± 10 mA
Storage Temperature Range	-65°C to $+150^\circ\text{C}$
Junction Temperature (Note 4)	$+150^\circ\text{C}$

Soldering Information

Lead Temperature, Infrared or Convection Reflow (20 sec)	235°C
Lead Temperature, Wave Solder (10 sec)	260°C

Operating Ratings (Note 1)

Supply Voltage ($V_S = V^+ - V^-$)	2.7V to 5.5V
Junction Temperature Range (Note 4)	
LMP8100A	-40°C to $+125^\circ\text{C}$
LMP8100	-40°C to $+85^\circ\text{C}$
Package Thermal Resistance (θ_{JA}) (Note 4)	
14-Pin SOIC	145°C/W

5V Electrical Characteristics

Unless otherwise specified, all limits are guaranteed for $T_A = 25^\circ\text{C}$. $V^+ = 5V$, $V^- = 0V$, $DGND = 0V$, $+IN = GRT = V^+/2$, $R_L = 10$ k Ω to $V^+/2$; Gain = 1 V/V. **Boldface** limits apply at the temperature extremes.

Symbol	Parameter	Conditions	Min (Note 6)	Typ (Note 5)	Max (Note 6)	Units
	Gain Error	LMP8100A $0V < +IN$ (DC) $< 3.5V$, $1 \text{ V/V} \leq \text{Gain} \leq 16 \text{ V/V}$,		0.015	0.03 0.03	%
	Gain Error	LMP8100 $0.5V < V_{OUT} < 4.5V$		0.015	0.075 0.075	
	LMP8100 Gain Error (Gain = 1 V/V) Extended +IN Range	$+IN > 3.5V$, $0.3V < V_{OUT} < 4.7V$			0.1 0.2	%
TCGE	Gain Drift	LMP8100A		0.5	2.2	ppm/ $^\circ\text{C}$
		LMP8100	Gain = 16	0.8	4.8	
V_{OS}	Input Offset Voltage	LMP8100A		± 50	± 250 ± 450	μV
		LMP8100		± 50	± 400 ± 600	
TCV_{OS}	Input Offset Temp Coefficient	(Note 8)		1.5	5	$\mu\text{V}/^\circ\text{C}$
I_B	Input Bias Current			0.1	5 100	pA
e_n	Input-Referred Noise Voltage	$f = 10 \text{ kHz}$, $1 \text{ V/V} \leq \text{Gain} \leq 16 \text{ V/V}$		12		$\text{nV}/\sqrt{\text{Hz}}$
		$f = 0.1 \text{ Hz}$ to 10 Hz , $1 \text{ V/V} \leq \text{Gain} \leq 16 \text{ V/V}$		3.8		μV_{PP}
BW	Bandwidth	$C1 = C0 = 0$, Gain = 1 V/V		33		MHz
		$C1 = C0 = 0$, Gain = 2 V/V		15.5		
		$C1 = C0 = 1$, Gain = 16 V/V		9.5		
SR	Slew Rate	(Note 7)		12		V/ μs
PSRR	Power Supply Rejection Ratio	$2.7V < V^+ < 5.5V$	90 85	100		dB
V_O	Output Swing High	$+IN = 5V$	4.9 4.85	4.95		V
	Output Swing Low	$+IN = 0V$		50	100 150	mV
I_O	Output Current	Sourcing and Sinking	15	20		mA
V_{IN}	Input Voltage Range		-0.2 0		5.2 5.0	V
I_S	Supply Current			5.3	6.0 7.2	mA

Symbol	Parameter	Conditions	Min (Note 6)	Typ (Note 5)	Max (Note 6)	Units
I_{PD}	Supply Current, Power Down			3.5	20 40	μA
	Feedback Resistance			5.6		$k\Omega$
R_{IN}	Input Impedance	$f = 10 \text{ Hz}$		>10		$G\Omega$

3.3V Electrical Characteristics

Unless otherwise specified, all limits are guaranteed for $T_A = 25^\circ C$. $V^+ = 3.3V$, $V^- = 0V$, $DGND = 0V$, $+IN = GRT = V^+/2$, $R_L = 10 k\Omega$ to $V^+/2$; Gain = 1 V/V. **Boldface** limits apply at the temperature extremes.

Symbol	Parameter	Conditions	Min (Note 6)	Typ (Note 5)	Max (Note 6)	Units	
	Gain Error	LMP8100A $0V < +IN < 1.8V$, $1 V/V \leq \text{Gain} \leq 16 V/V$,		0.015	0.03 0.03	%	
	Gain Error	LMP8100 $0.3V < V_{OUT} < 3.0V$		0.015	0.075 0.075		
	LMP8100 Gain Error (Gain = 1 V/V) Extended +IN Range	$+IN > 1.8V$, $0.3V < V_{OUT} < 3.0V$			0.1 0.2	%	
TCGE	Gain Drift	LMP8100A	Gain = 16		0.5	2.2	ppm/ $^\circ C$
		LMP8100	Gain = 16		0.8	4.8	
V_{OS}	Input Offset Voltage	LMP8100A			± 50	± 250 ± 450	μV
		LMP8100			± 50	± 400 ± 600	
TCV_{OS}	Input Offset Temp Coefficient	(Note 8)		1.5	5	$\mu V/^\circ C$	
I_B	Input Bias Current			0.1	5 100	μA	
e_n	Input-referred Noise Voltage	$f = 10 \text{ kHz}$, $1 V/V \leq \text{Gain} \leq 16 V/V$		12		nV/\sqrt{Hz}	
		$f = 0.1 \text{ Hz to } 10 \text{ Hz}$, $1 V/V \leq \text{Gain} \leq 16 V/V$		3.8		μV_{PP}	
BW	Bandwidth	$C1 = C0 = 0$, Gain = 1 V/V		33		MHz	
		$C1 = C0 = 0$, Gain = 2 V/V		15.5			
		$C1 = C0 = 1$, Gain = 16 V/V		9.5			
SR	Slew Rate	(Note 7)		12		$V/\mu s$	
PSRR	Power Supply Rejection Ratio	$2.7V < V^+ < 3.6V$	90 80	100		dB	
V_O	Output Swing High	$+IN = 3.3V$	3.2 3.15	3.25		V	
	Output Swing Low	$+IN = 0V$		50	100 150	mV	
I_O	Output Current	Sourcing and Sinking	15	20		mA	
V_{IN}	Input Voltage Range		-0.2 0		3.5 3.3	V	
I_S	Supply Current			5.1	5.8 7.0	mA	
I_{PD}	Supply Current, Power Down			1.8	20 40	μA	
	Feedback Resistance			5.6		$k\Omega$	
R_{IN}	Input Impedance			>10		$G\Omega$	

Electrical Characteristics (Serial Interface)

Unless otherwise specified, all limits guaranteed for $T_A = 25^\circ\text{C}$, $V^+ - V^- \geq 2.7\text{V}$, $V_D = V^+ - \text{DGND} \geq 2.5\text{V}$.

Symbol	Parameter	Conditions	Min (Note 6)	Typ (Note 5)	Max (Note 6)	Units
V_{IL}	Logic Low Threshold				$0.3 \times V_D$	V
V_{IH}	Logic High Threshold		$0.7 \times V_D$			V
I_{SDO}	Output Source Current, SDO	$V_D = 3.3\text{V}$ or 5.0V , $\overline{CS} = 0\text{V}$, $V_{OH} = V^+ - 0.7\text{V}$	-7			mA
	Output Sink Current, SDO	$V_D = 3.3\text{V}$ or 5.0V , $\overline{CS} = 0\text{V}$, $V_{OL} = 1.0\text{V}$	10			
I_{OZ}	Output Tri-state Leakage Current, SDO	$V_D = 3.3\text{V}$ or 5.0V , $\overline{CS} = V_D = 3.3\text{V}$ or 5V			± 1	μA
t_1	High Period, SCK	(Note 9)	100			ns
t_2	Low Period, SCK	(Note 9)	100			ns
t_3	Set Up Time, \overline{CS} to SCK	(Note 9)	50			ns
t_4	Set Up Time, SDI to SCK	(Note 9)	30			ns
t_5	Hold Time, SCK to SDI	(Note 9)	10			ns
t_6	Prop. Delay, SCK to SDO	(Note 9)			60	ns
t_7	Hold Time, SCK Transition to \overline{CS} Rising Edge	(Note 9)	50			ns
t_8	\overline{CS} Inactive	(Note 9)	50			ns
t_9	Prop. Delay, \overline{CS} to SDO Active	(Note 9)			50	ns
t_{10}	Prop. Delay, \overline{CS} to SDO Inactive	(Note 9)			50	ns
t_{11}	Hold Time, SCK Transition to \overline{CS} Falling Edge	(Note 9)	10			ns
t_R/t_F	Signal Rise and Fall Times	(Note 9)	1.5		5	ns

Note 1: Absolute Maximum Ratings indicate limits beyond which damage to the device may occur. Operating Ratings indicate conditions for which the device is intended to be functional, but for which specific performance is not guaranteed. For guaranteed specifications and the test conditions, see Electrical Characteristics.

Note 2: Human Body Model, applicable std. MIL-STD-883, Method 3015.7. Machine Model, applicable std. JESD22-A115-A (ESD MM std. of JEDEC). Field-Induced Charge-Device Model, applicable std. JESD22-C101-C (ESD FICDM std. of JEDEC).

Note 3: The short circuit test is a momentary test which applies to both single-supply and split-supply operation. Continuous short circuit operation at elevated ambient temperature can exceed the maximum allowable junction temperature of 150°C .

Note 4: The maximum power dissipation is a function of $T_{J(\text{MAX})}$, θ_{JA} . The maximum allowable power dissipation at any ambient temperature is $P_D = (T_{J(\text{MAX})} - T_A) / \theta_{JA}$. All numbers apply for packages soldered directly onto a PC Board.

Note 5: Typical Values indicate the most likely parametric norm as determined at the time of characterization. Actual typical values may vary over time and will also depend on the application and configuration. The typical values are not tested and are not guaranteed on shipped production material.

Note 6: All limits are guaranteed by testing or statistical analysis.

Note 7: Slew rate is the average of the rising and falling slew rates.

Note 8: The offset voltage average drift is determined by dividing the value of V_{OS} at the temperature extremes by the total temperature change.

Note 9: Load for these tests is shown in the Timing Diagram Test Circuit.

Connection Diagram

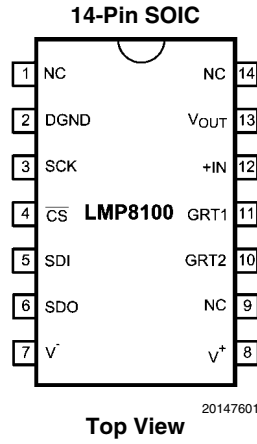

Ordering Information

Package	Part Number	Package Marking	Transport Media	NSC Drawing
14-Pin SOIC	LMP8100AMA	LMP8100AMA	55 Units/Rail	M14A
	LMP8100AMAX		2.5k units Tape and Reel	
	LMP8100MA	LMP8100MA	55 Units/Rail	
	LMP8100MAX		2.5k units Tape and Reel	

Timing Diagram Test Circuit

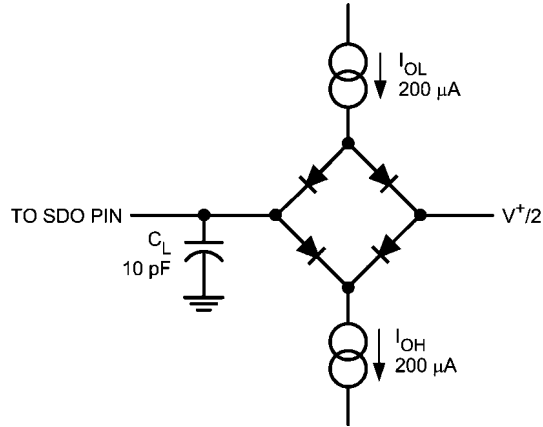

20147653

Timing Diagram

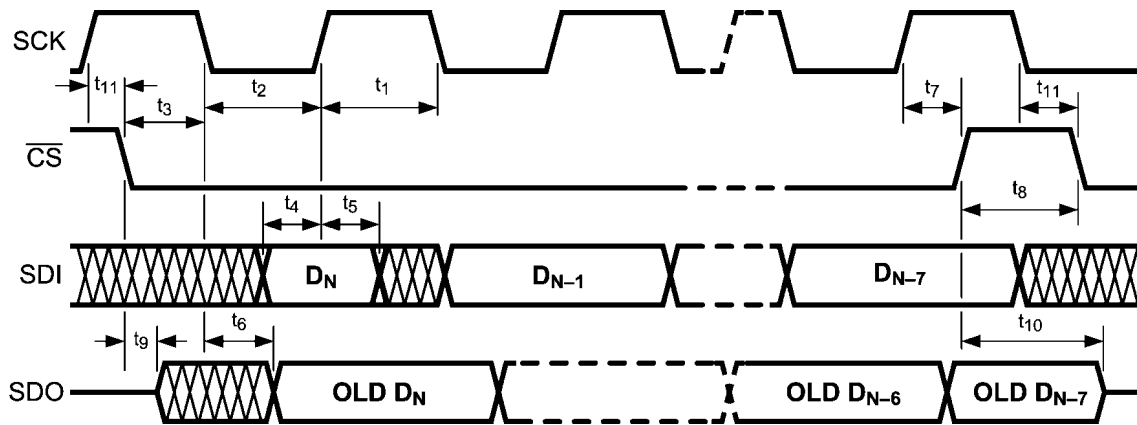

20147603

Test Circuit Diagram

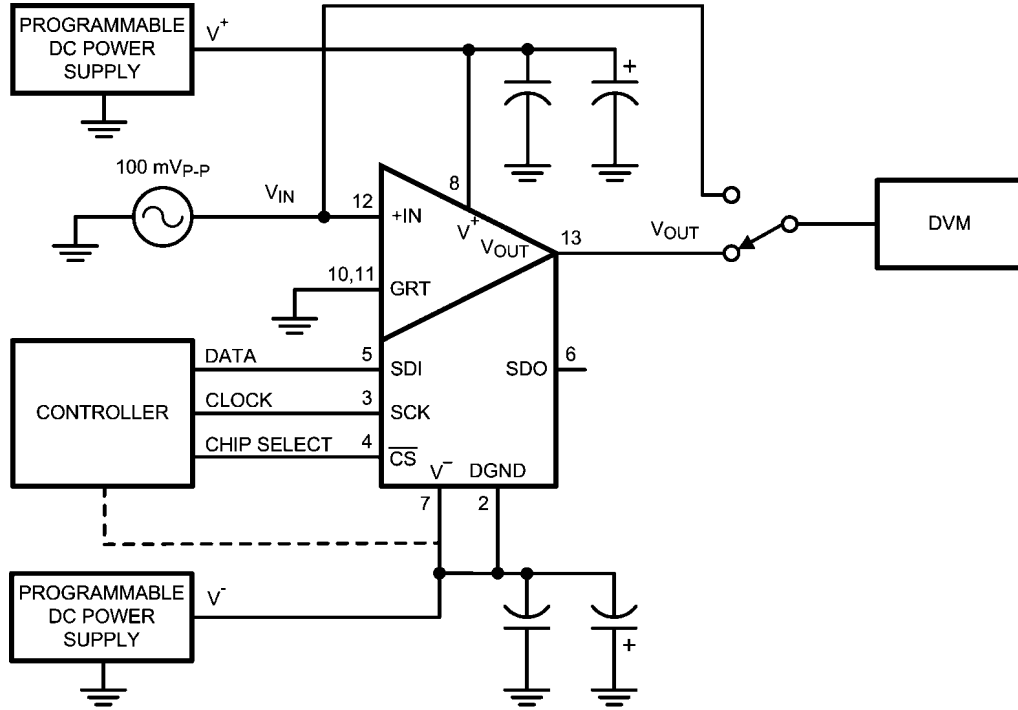

GAIN ERROR TEST

$$V_{IN(P-P)} = V_{OUT(P-P)} / A_V$$

Where: $V_{OUT(P-P)} = 3V$
 $2V/V \leq A_V \leq 16V/V$

$$A_{V(MEASURED)} = V_{OUT(P-P)} / V_{IN(P-P)}$$

$$\text{GAIN ERROR (\%)} = \left| \frac{A_{V(MEASURED)} - A_{V(SPEC)}}{A_{V(SPEC)}} \right| \times 100$$

SMALL SIGNAL GAIN ERROR TEST

Where: $A_V = 1V/V$
 $V_{IN(P-P)} = 100mV$
 $V^+ - V^- = 5V$ ($V^+ - V^- = 3.3V$)
 $1.5V \leq V^+ \leq 5.0V$ ($1.5V \leq V^+ \leq 3.3V$)
 $-3.5V \leq V^- \leq 0V$ ($-1.8V \leq V^- \leq 0V$)

$$\text{SMALL SIGNAL GAIN ERROR (\%)} = \left| \frac{V_{OUT(P-P)} - V_{IN(P-P)}}{V_{IN(P-P)}} \right| \times 100$$

Test Circuit

20147609

Typical Performance Characteristics

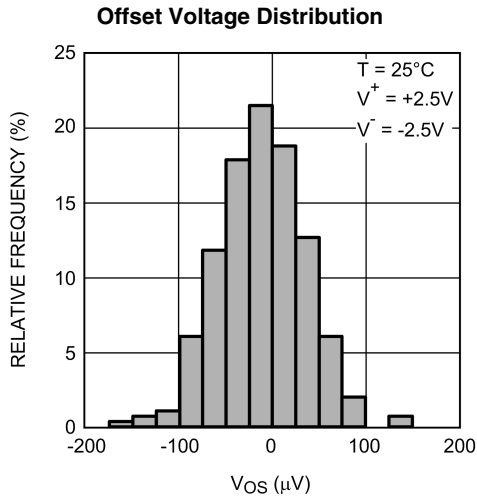

20147685

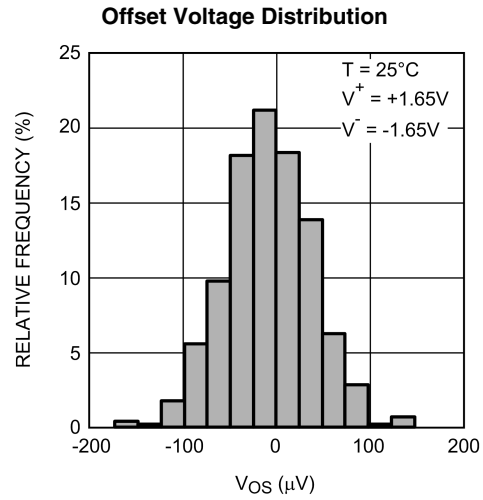

20147686

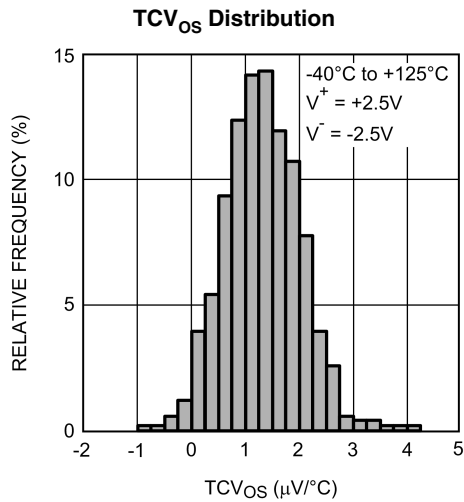

20147683

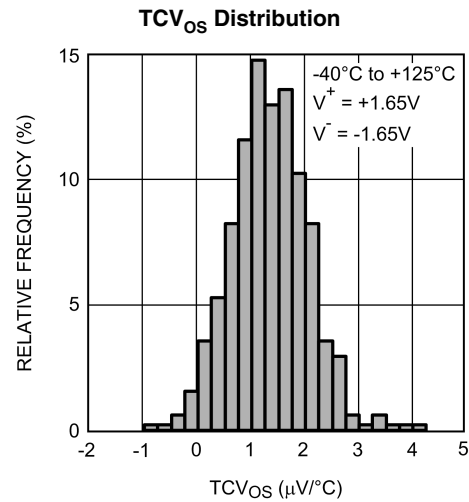

20147684

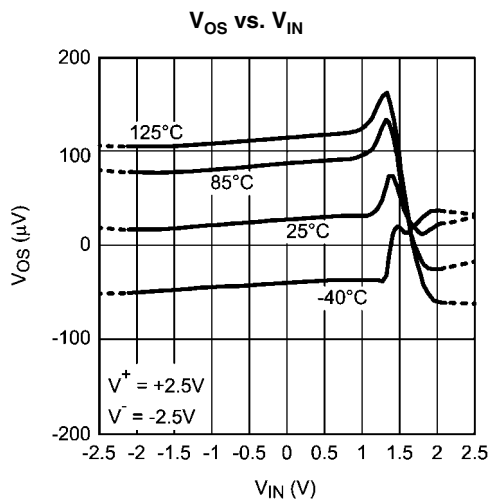

20147666

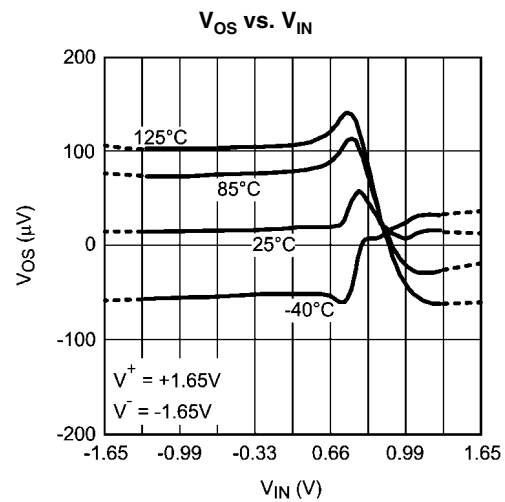

20147667

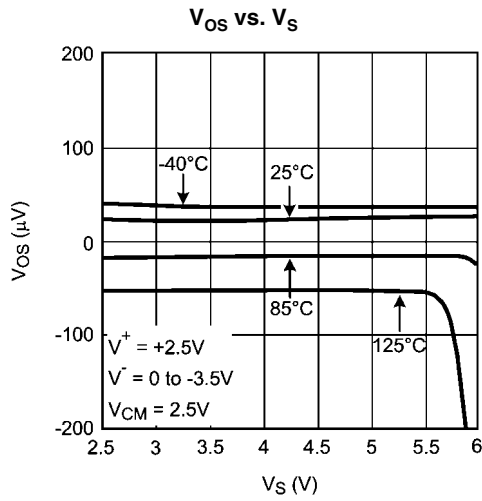

20147665

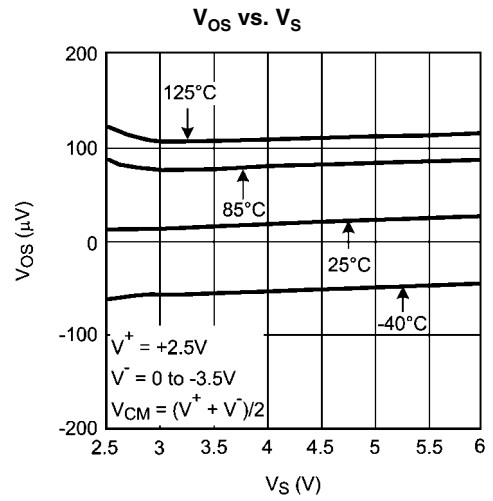

20147664

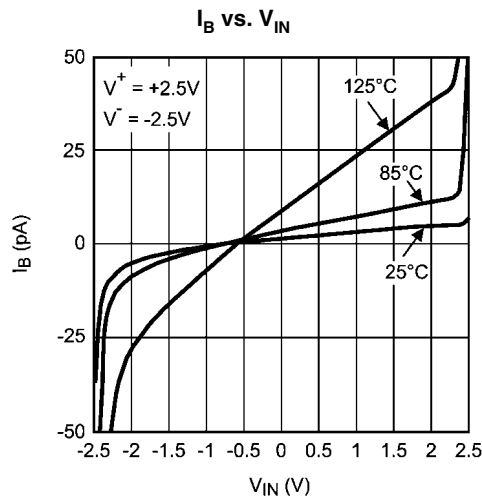

20147662

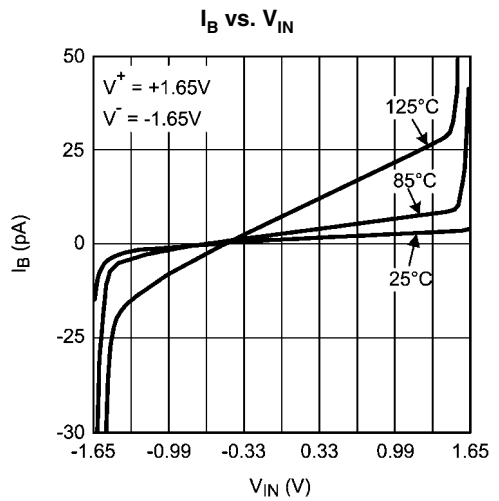

20147663

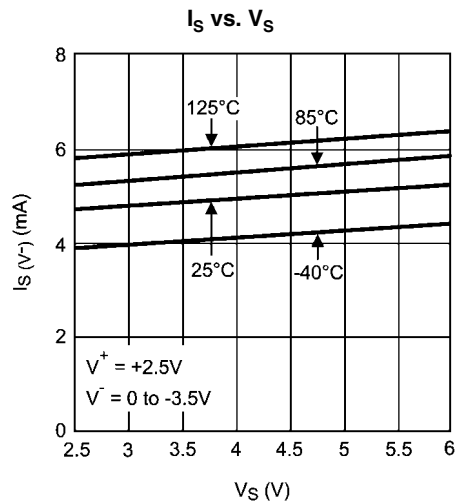

20147660

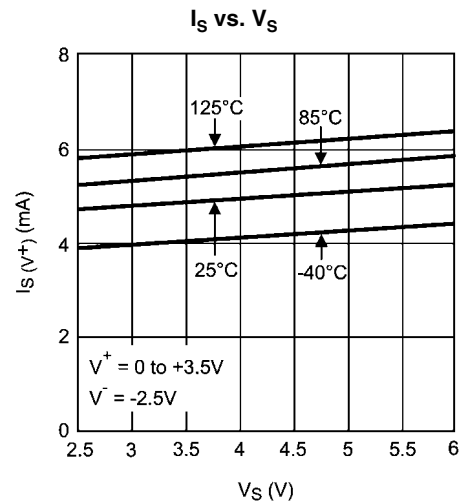

20147661

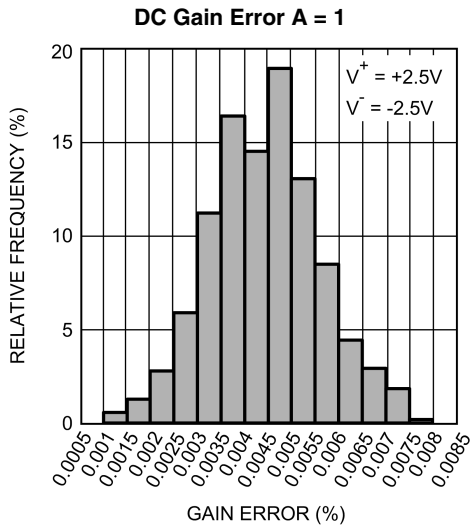

20147689

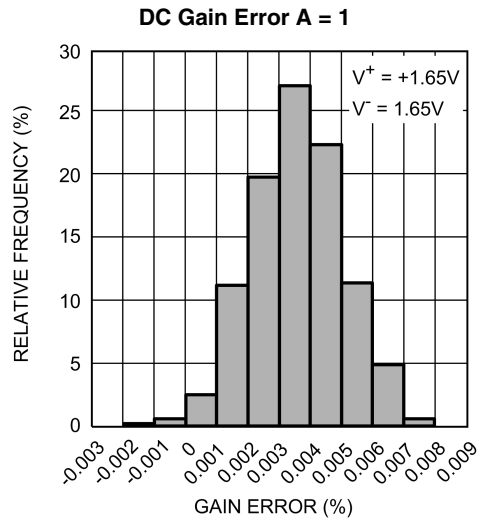

20147687

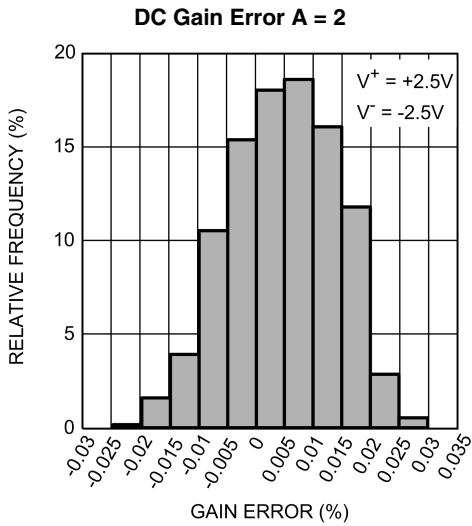

20147690

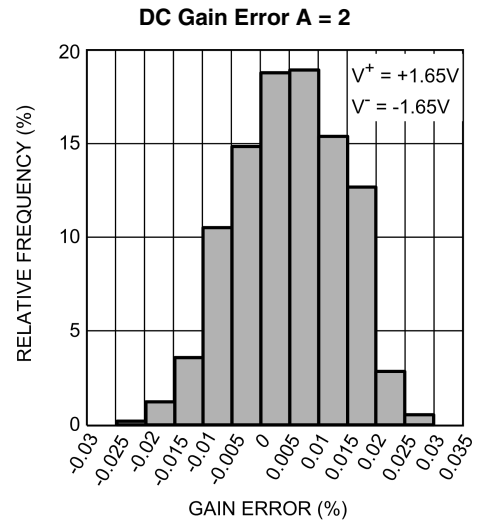

20147688

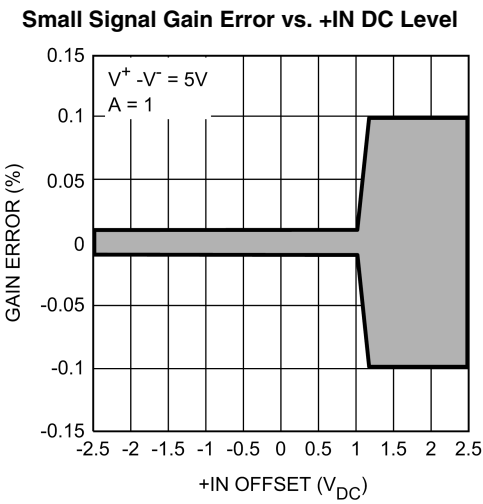

20147633

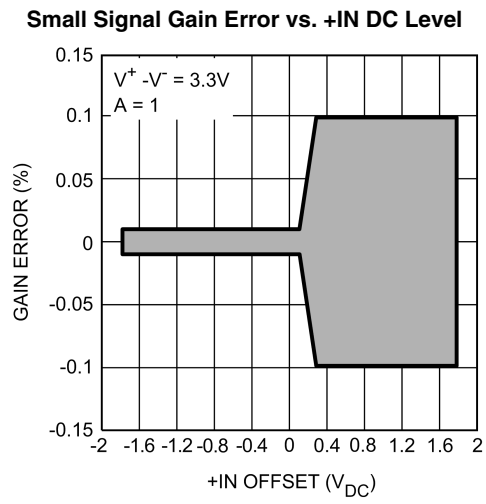

20147651

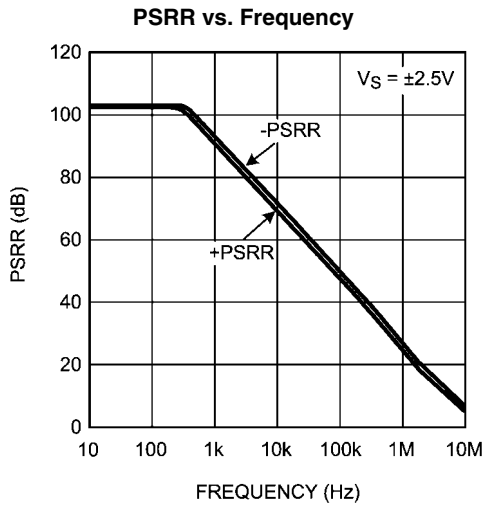

20147610

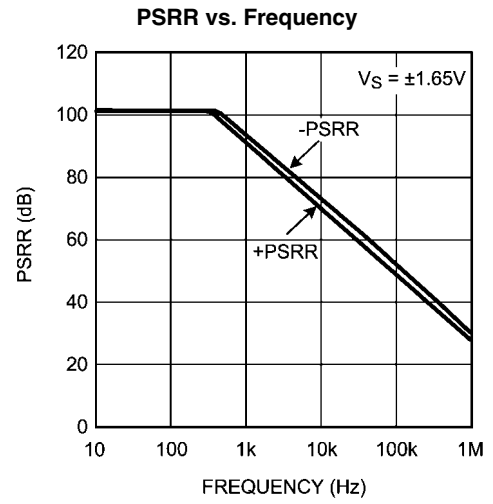

20147611

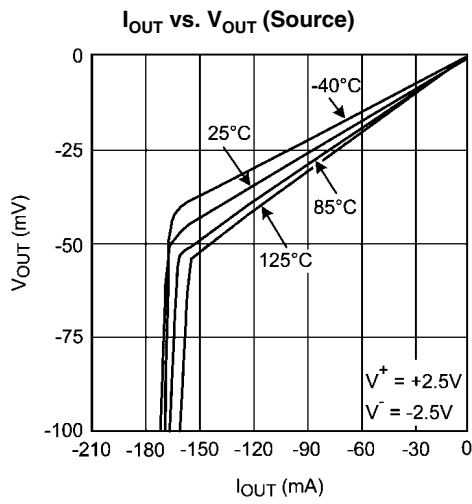

20147669

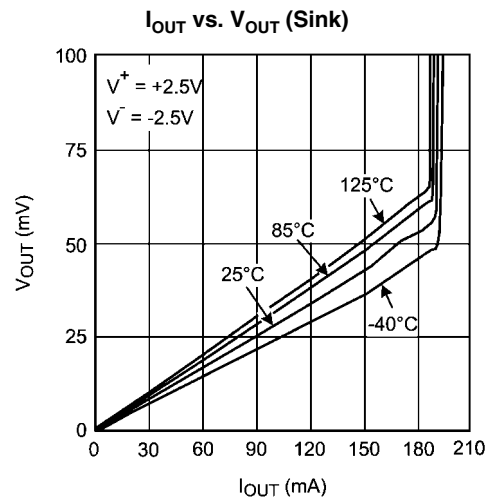

20147668

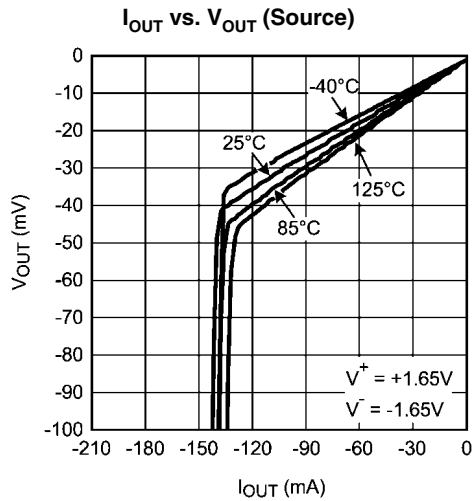

20147671

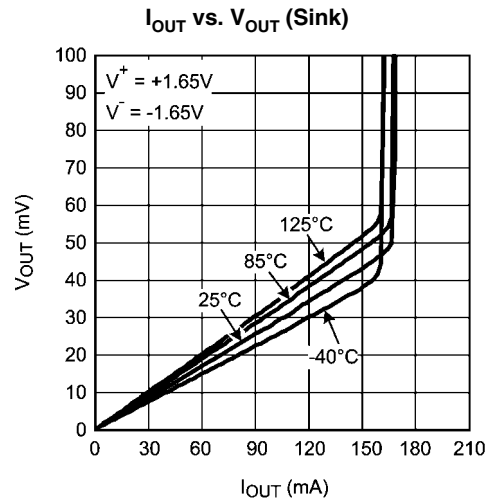

20147670

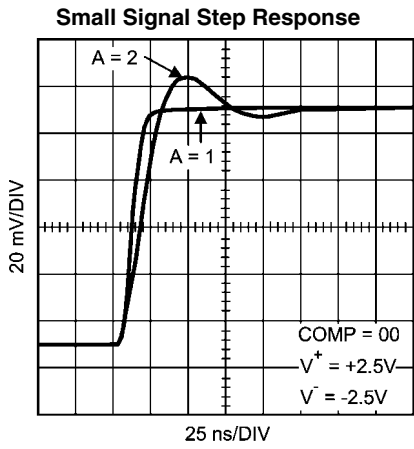

20147635

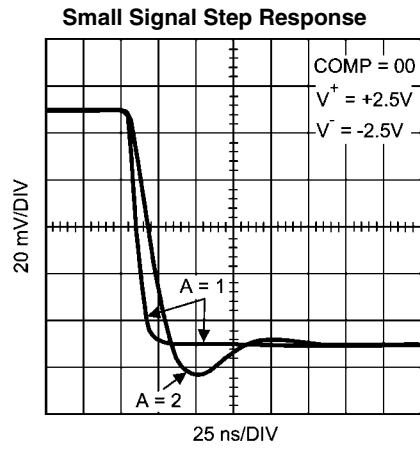

20147636

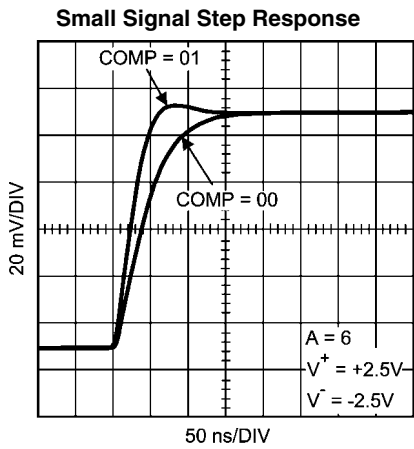

20147637

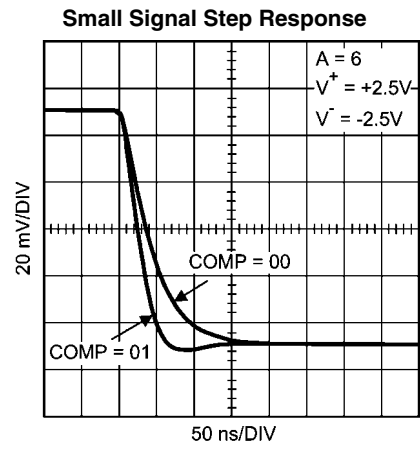

20147638

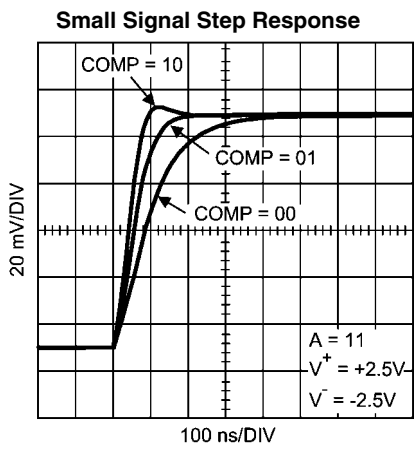

20147639

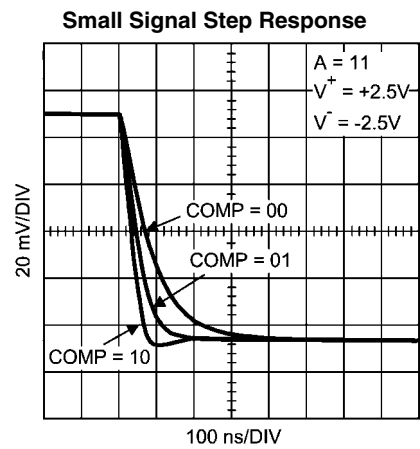

20147640

Small Signal Step Response

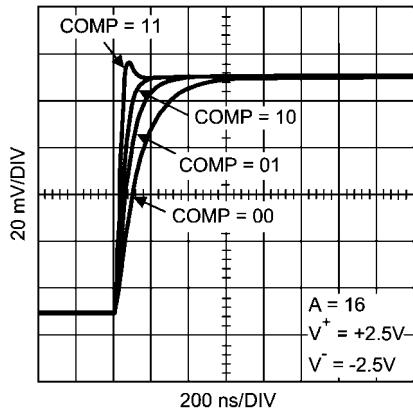

20147641

Small Signal Step Response

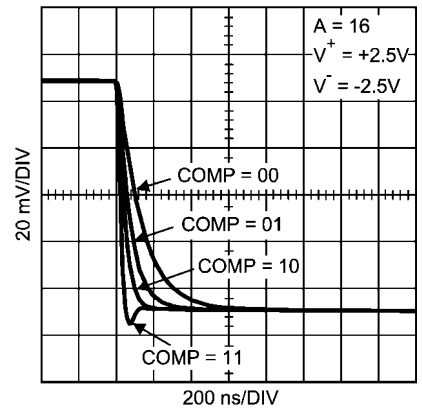

20147642

Large Signal Step Response

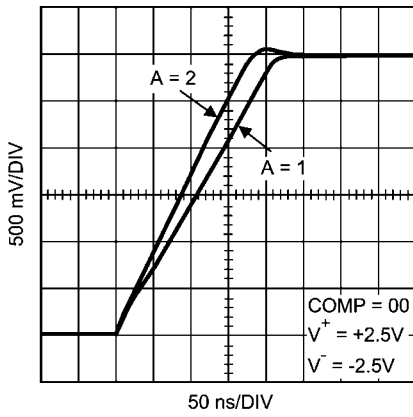

20147643

Large Signal Step Response

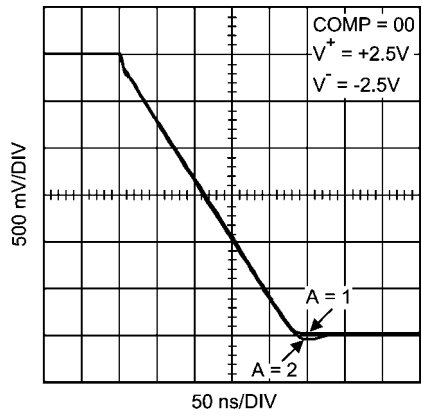

20147644

Large Signal Step Response

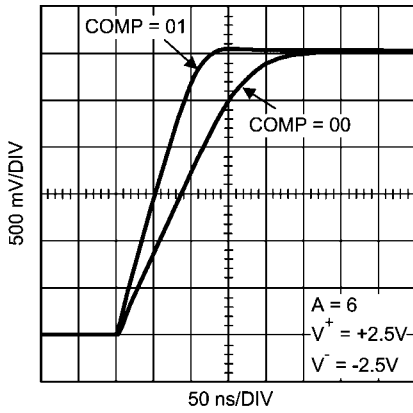

20147645

Large Signal Step Response

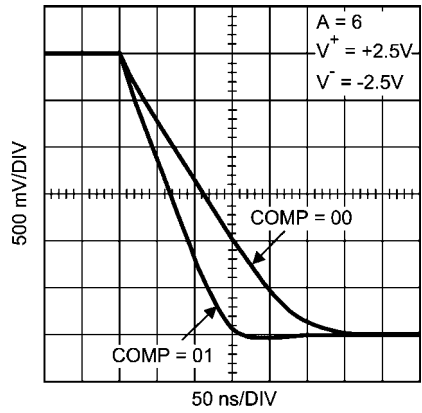

20147646

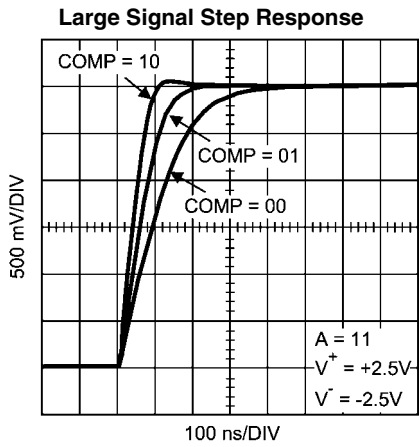

20147647

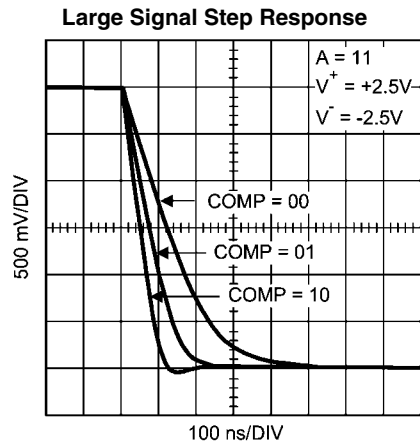

20147648

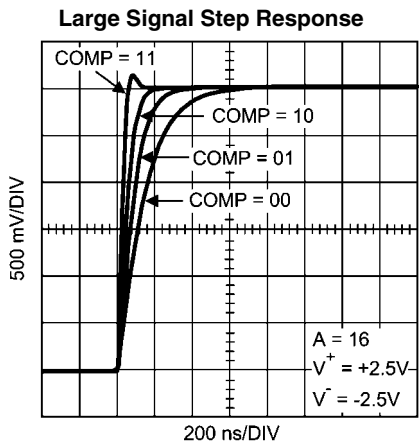

20147649

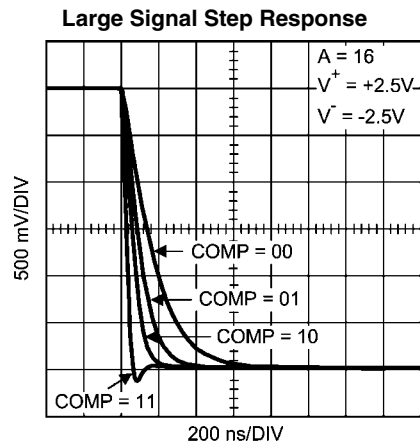

20147650

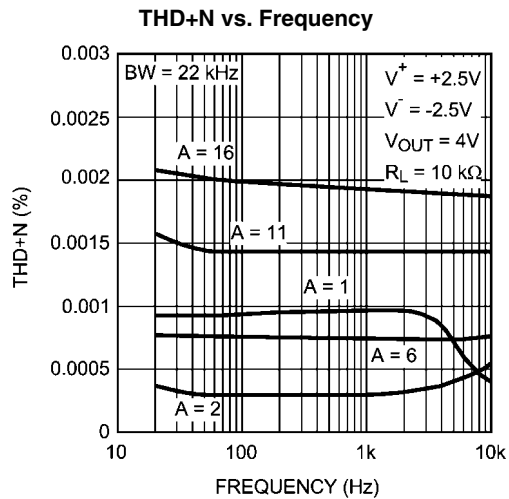

20147675

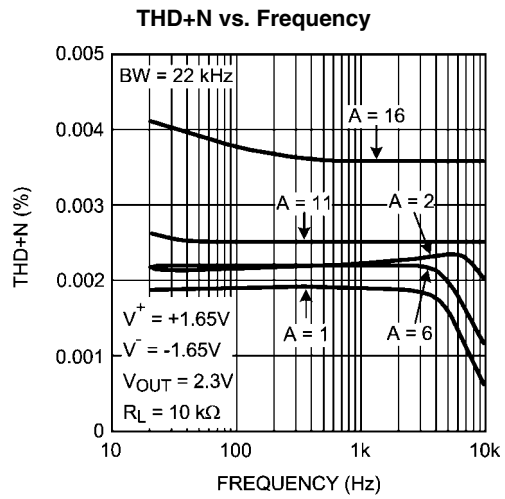

20147674

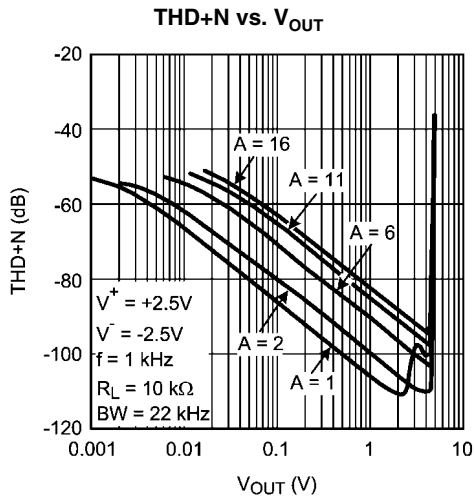

20147673

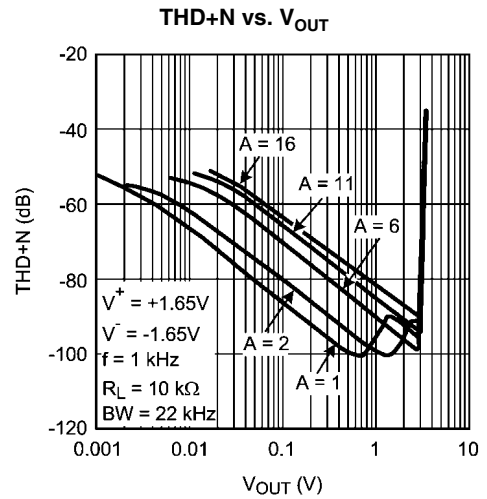

20147672

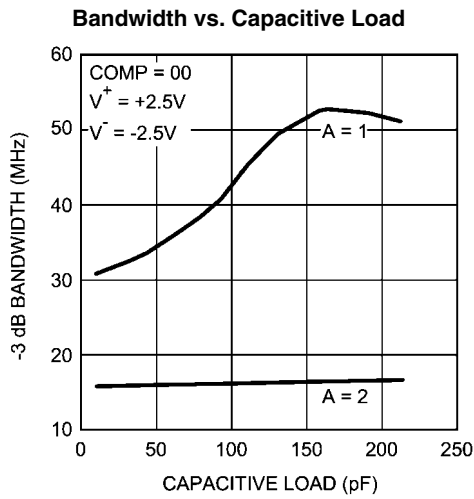

20147617

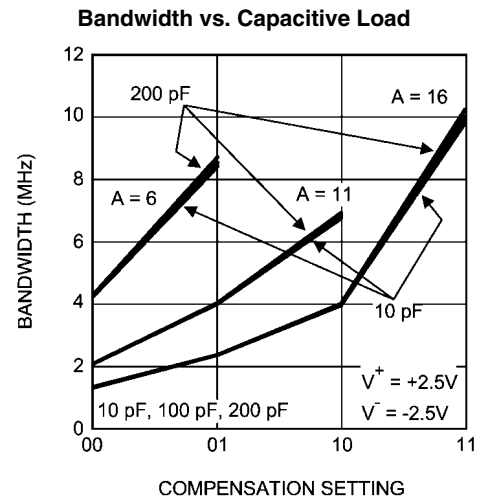

20147618

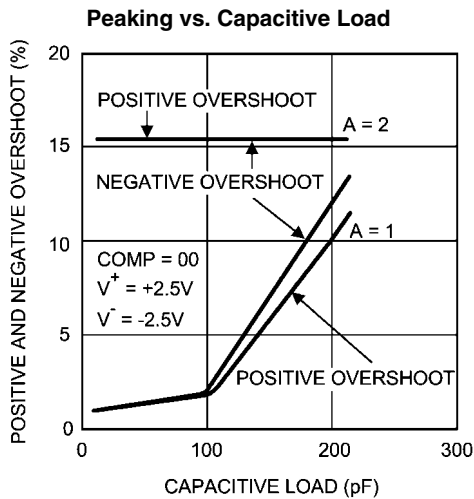

20147621

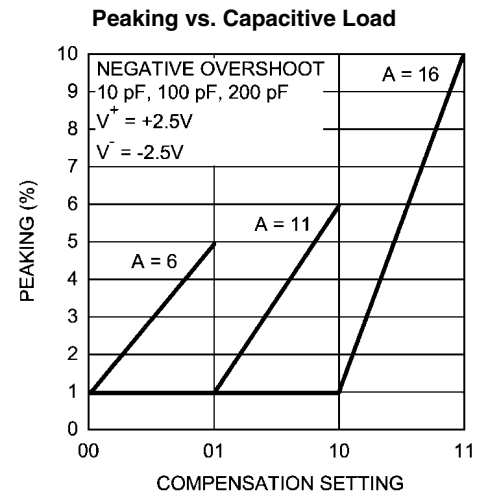

20147622

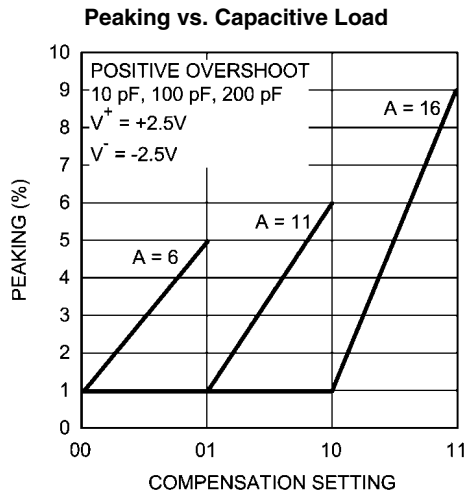

20147623

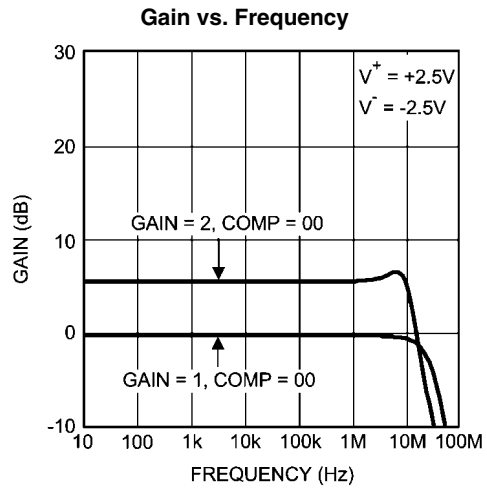

20147630

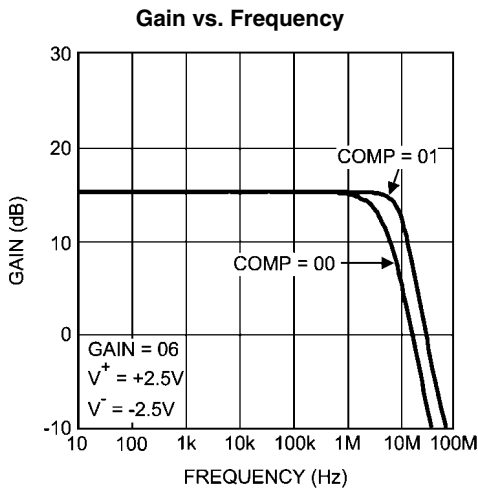

20147629

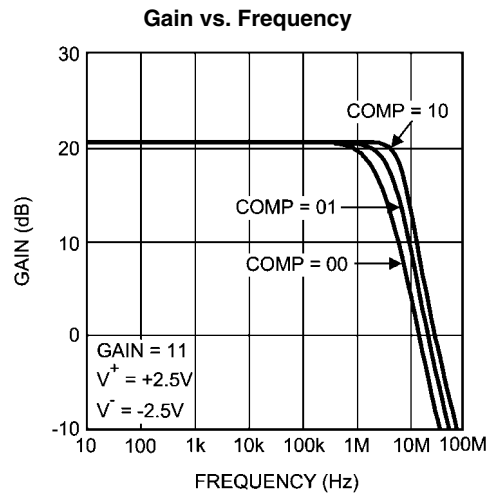

20147628

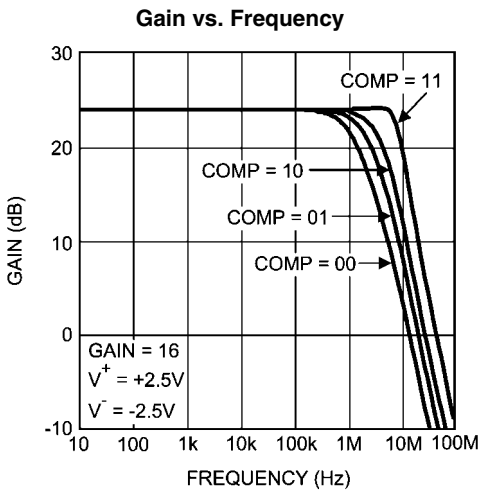

20147627

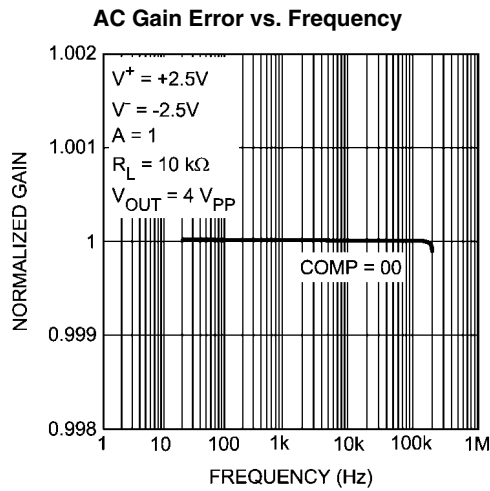

20147656

AC Gain Error vs. Frequency

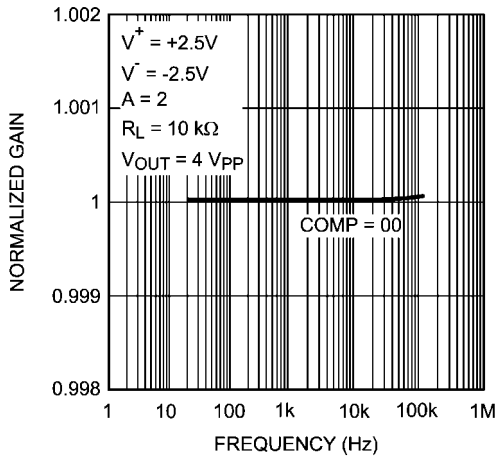

20147655

AC Gain Error vs. Frequency

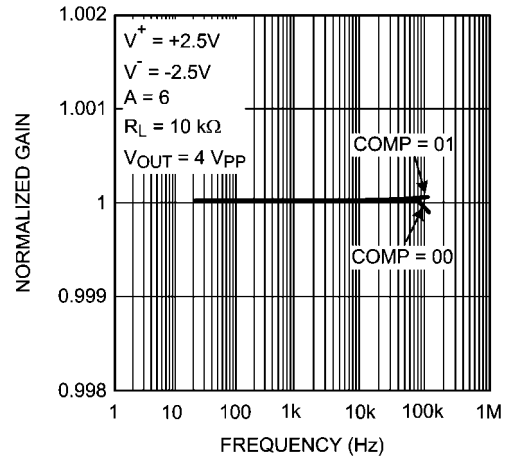

20147657

AC Gain Error vs. Frequency

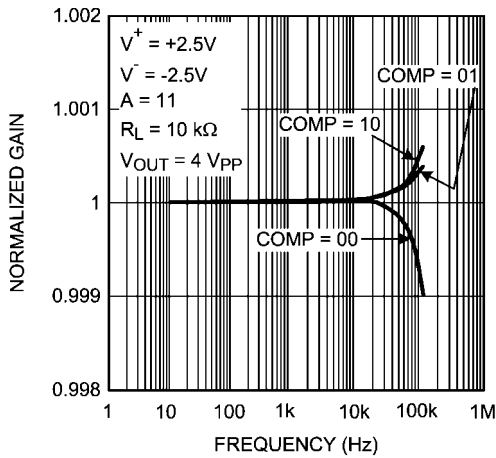

20147658

AC Gain Error vs. Frequency

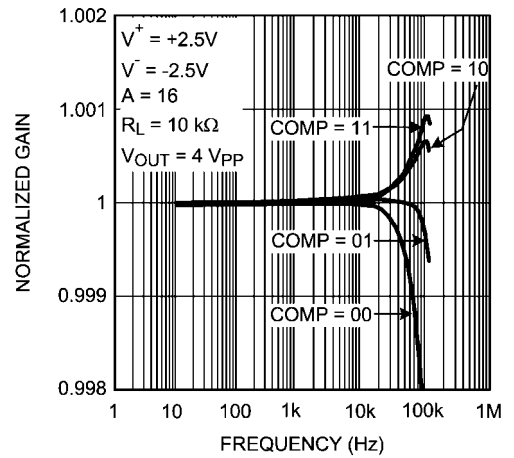

20147659

Noise vs. Frequency

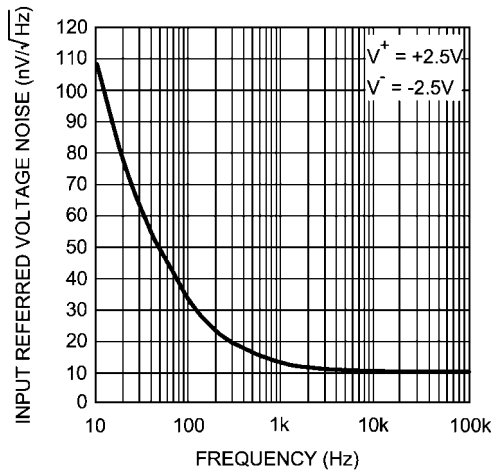

20147654

0.1 Hz to 10 Hz Noise

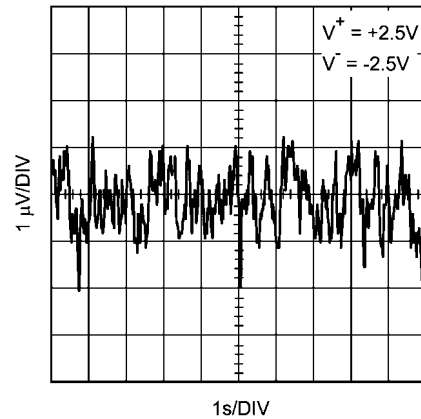

201476a2

Closed Loop Output Impedance vs. Frequency

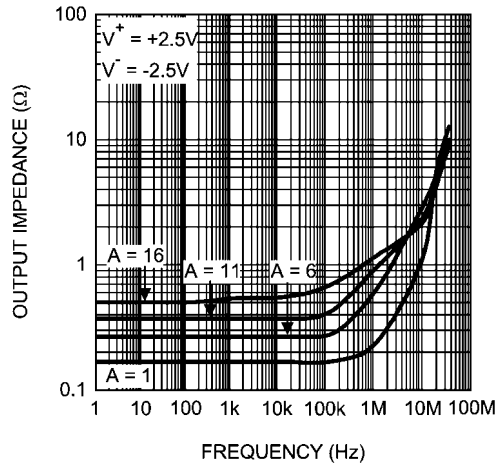

20147631

Input Impedance

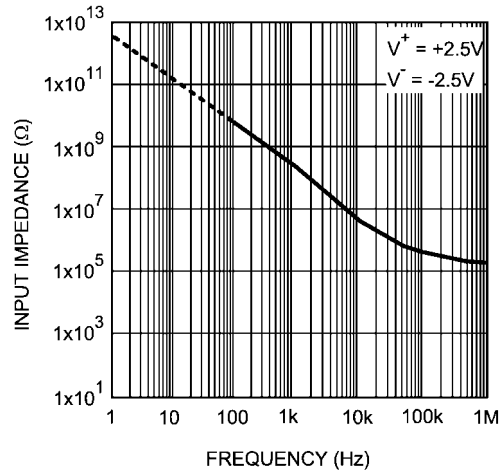

201476a1

SDO V vs. I

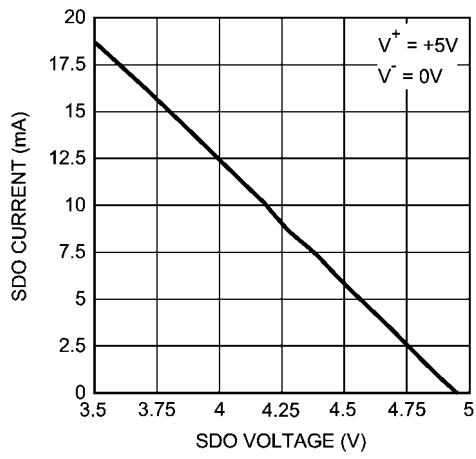

20147634

SDO V vs. I

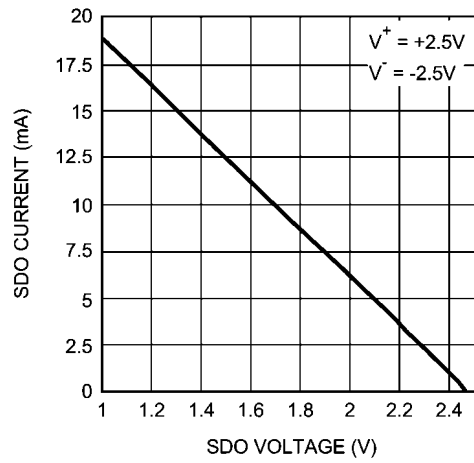

20147652

Applications Information

LIFETIME DRIFT

Offset voltage (V_{OS}) and gain are electrical parameters which may drift over time. This drift, known as lifetime drift, is very common in operational amplifiers; however, its effect is more evident in precision amplifiers. This is due to the very low offset voltage specification and very precise gain specification of the LMP8100. The LMP8100 has an option to zero out the offset voltage. When the zero bit of the register is set high, +IN is connected to GRT. Output offset voltage can be measured and adjusted out of the signal path. See the "Input Zeroing" section, for more information. Numerous reliability tests have been performed to characterize this drift for the LMP8100. Prior to each long term reliability test the input offset voltage and gain at 2X and 16X of each LMP8100 was measured at room temperature.

The long term reliability tests include Operating Life Time (OPL) performed at 150°C for an extended period of time and Temperature Humidity Bias Testing (THBT) at 85°C and 85% humidity for an extended period of time. The offset voltage and gain of 2X and 16X were measured again at room temperature after each reliability test.

The offset voltage drift is the difference between the initial measurement and the later measurement, after the reliability test.

The gain drift is the percentage difference between the initial measurement and the later measurement, after the reliability test. Figure 1 – Figure 4 show the offset voltage drift and gain drift after 1000 hours of OPL.

Figure 5 – Figure 8 show the offset voltage drift and gain drift after 1000 hours of THBT.

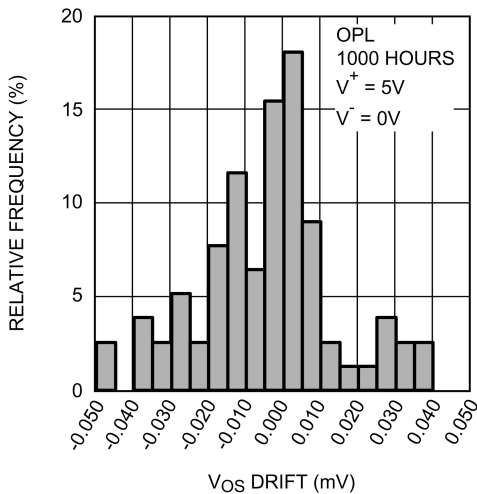
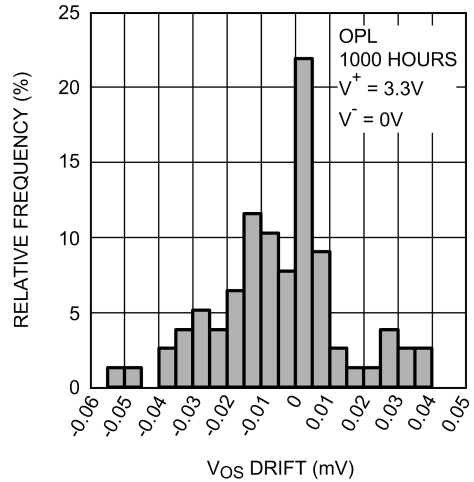

FIGURE 1. OPL V_{OS} Drift

20147691



20147692

FIGURE 2. OPL V_{OS} Drift

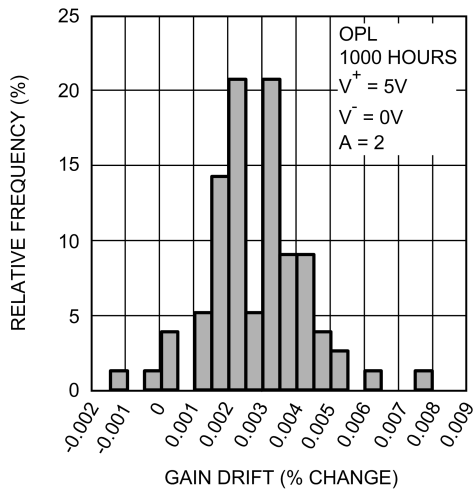

20147693

FIGURE 3. OPL Gain Drift, $A = 2$

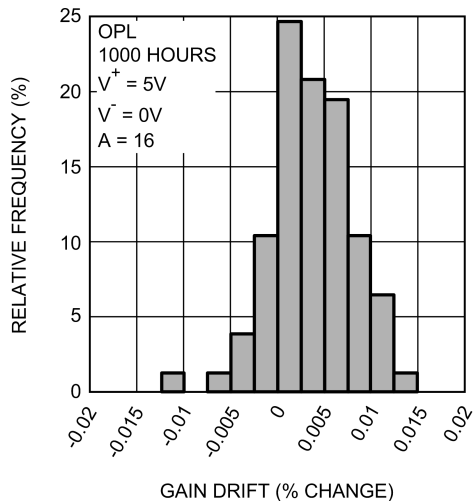

20147694

FIGURE 4. OPL Gain Drift, $A = 16$

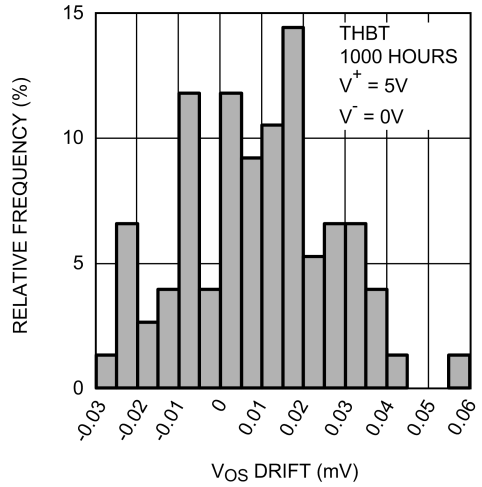

20147695

FIGURE 5. THBT V_{OS} Drift

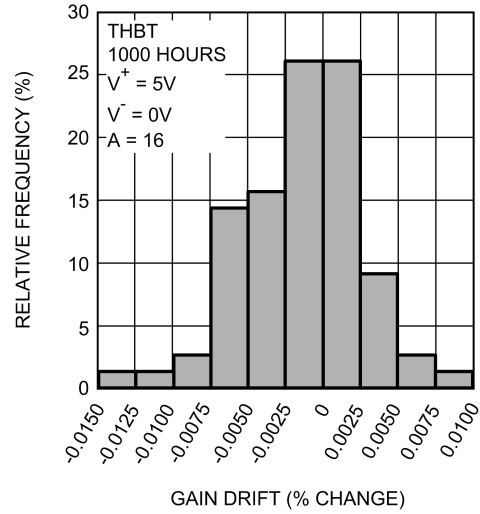

20147698

FIGURE 8. THBT Gain Drift, $A = 16$

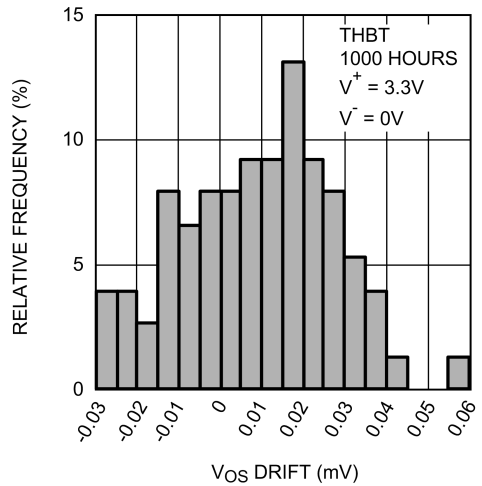

20147696

FIGURE 6. THBT V_{OS} Drift

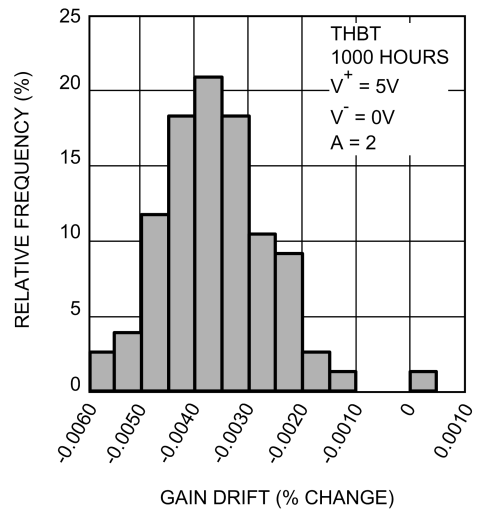

20147697

FIGURE 7. THBT Gain Drift, $A = 2$

POWER-ON RESET

The LMP8100 has a power-up reset feature that sets all the register bits to 0 when the part is powered up. To implement this feature the \overline{CS} and SCK pins must be held at or above V_{IH} when the LMP8100 is powered-up. Failure to power up in this method can lead to an unpredictable state of the register bits after power-up.

CONTROL REGISTER

The control register retains the information which controls the amplifier gain, bandwidth compensation, input zeroing, and power down. The register is loaded by way of the serial control interface. The register is double buffered so that changes can be made with minimum effect on amplifier performance. Table 1 shows the organization of the control register. Table 2 gives the codes for gain setting, input zeroing and power down control. Table 3 shows the codes for the four gain-bandwidth compensation levels.

TABLE 1. Control Register Format

C1	C0	Zero	PD	G3	G2	G1	G0
MSB							LSB

C0, C1: Compensation setting
Zero: Zero Input
PD: Power Down
G0 to G3: Gain setting

TABLE 2. Input Zero, Power-Down and Gain Setting Codes

Zero	PD	G3	G2	G1	G0	Non-Inverting Gain
	0	0	0	0	0	1
	0	0	0	0	1	2
	0	0	0	1	0	3
	0	0	0	1	1	4
	0	0	1	0	0	5
	0	0	1	0	1	6
	0	0	1	1	0	7
	0	0	1	1	1	8
	0	1	0	0	0	9
	0	1	0	0	1	10
	0	1	0	1	0	11
	0	1	0	1	1	12
	0	1	1	0	0	13
	0	1	1	0	1	14
	0	1	1	1	0	15
	0	1	1	1	1	16
X	1	X	X	X	X	Power Down
1	0	X	X	X	X	Zero Input

TABLE 3. Amplifier Gain Compensation Codes

C1	C0	Compensation Level	Condition
0	0	0	Maximum Compensation
0	1	1	
1	0	2	
1	1	3	Minimum Compensation

AMPLIFIER GAIN SETTING AND BANDWIDTH COMPENSATION CONTROL

The gain of the LMP8100 is set to one of 16 levels under program control by setting the appropriate bits G[3:0] of the control register with a number from 00h to 15h. This sets the gain to a level from 1 V/V to 16 V/V respectively.

The gain-bandwidth compensation is also selectable to one of four levels under program control. The amount of compensation can be decreased to maximize the available bandwidth as the gain of the amplifier is increased. The compensation level is selected by setting bits C[1:0] of the control register with a number from 00b to 11b with 00b being maximum compensation and 11b being minimum compensation. *Table 4* shows the bandwidths achieved at several gain and compensation settings. It will be noted that for gains between X1 and X5, the recommended compensation setting is 00b. For gain settings between X6 and X10, compensation settings may be 00b and 01b. Gain settings between X11 and X15 may use the three bandwidth compensation settings between 00b and 10b. At a gain of X16, all bandwidth compensation ranges may be used. Note that, for lower gains, it is possible to under-compensate the amplifier into instability.

TABLE 4. Amplifier Gain and Compensation vs. Bandwidth

Gain		Compensation Bits		3 dB Bandwidth (MHz)
V/V	dB	C1	C0	
1	0	0	0	33.0
2	6.02	0	0	15.5
6	15.6	0	0	4.2
6	15.6	0	1	8.3
11	20.8	0	0	2.0
11	20.8	0	1	3.9
11	20.8	1	0	6.6
16	24.1	0	0	1.3
16	24.1	0	1	2.3
16	24.1	1	0	3.8
16	24.1	1	1	9.5

NON-INVERTING AMPLIFIER OPERATION

The principal application of the LMP8100 is as a non-inverting amplifier as shown in the simplified schematic, *Figure 9*. The amplifier supply voltage (V+ to V-) is specified as 5.5V maximum. The V- supply pin is connected to the system ground for single supply operation. V- can be returned to a negative voltage when required by the application. The digital supply voltage for the serial interface is applied between the V+ supply pin and DGND.

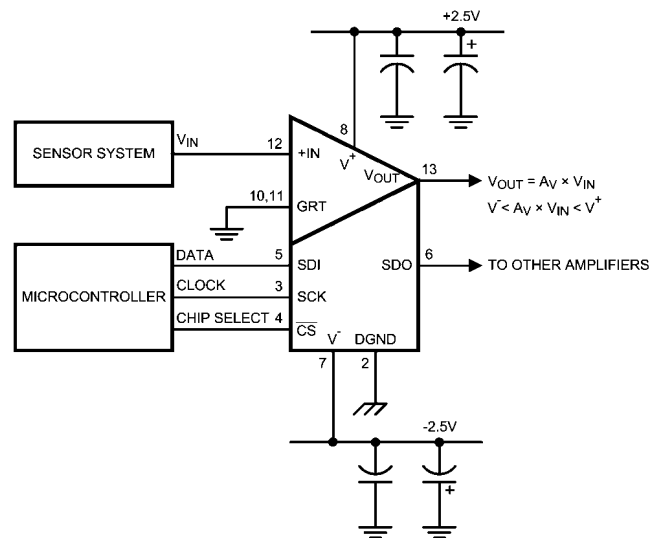

20147605

FIGURE 9. Basic Non-Inverting Amplifier

GRT PINS

The GRT pins must have a low impedance connection to either ground or a reference voltage. Any parasitical impedance on these pins will affect the gain accuracy of the LMP8100. *Figure 10* shows a simplified schematic of the LMP8100 showing the internal gain resistors and an external parasitical resistance R_P . The gain of the LMP8100 is determined by R_F and R_G , the values of which are set by the internal register. The gain of the amplifier is given by the equation

$$GAIN = 1 + \frac{R_F}{R_G}$$

Any resistance between the GRT pins and either ground or a reference voltage will change the gain to

$$GAIN = 1 + \frac{R_F}{R_G + R_P}$$

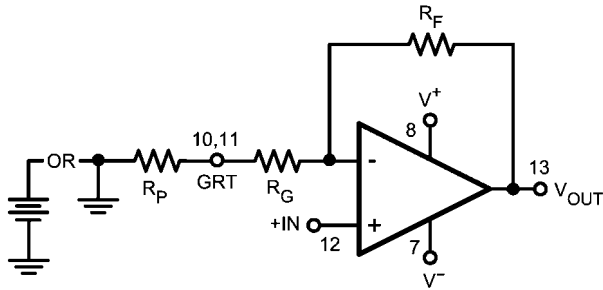

20147679

FIGURE 10. LMP8100 with External Parasitical Resistance

The connection between the GRT pins and ground or a reference voltage should be as short as possible using wide

traces to minimize the parasitical resistance. *Figure 11* shows two suggested methods of connecting the GRT pins to a ground plane on the same layer or to a ground plane on a different layer of the PCB.

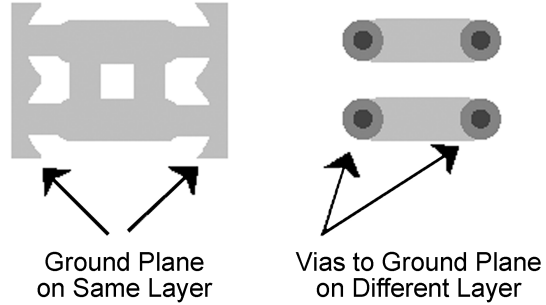

20147676

FIGURE 11. GRT Connection Methods

The GRT pin can be connected to a reference voltage source to provide an offset adjustment to the gain function. Any DC resistance that may be present between the voltage source and the GRT pin must be kept to an absolute minimum to avoid introducing gain errors into the circuit.

INPUT ZEROING

Measurements made with the LMP8100 in the signal path may be adjusted for the output offset voltage of the amplifier. For example: The measurement of V_{OUT} for offset correction might be made using an ADC under microprocessor control. Output offset is measured under program control by setting the ZERO bit in the programming register. In this mode, +IN is disconnected from the input pin and internally connected to the GRT input. *Figure 12* shows the LMP8100 in the input zeroing mode.

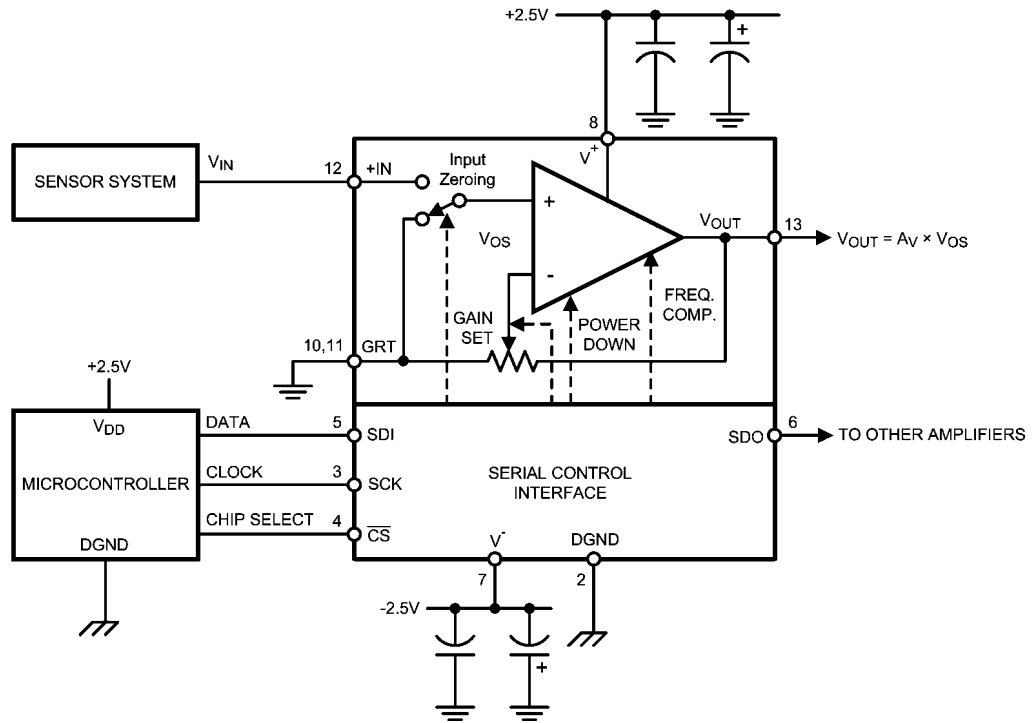

20147606

FIGURE 12. Non-Inverting Input Zeroing Function

SERIAL CONTROL INTERFACE OPERATION

The LMP8100 gain, bandwidth compensation, power down, and input zeroing are controlled by data stored in a programming register. Data to be written into the control register is first loaded into the LMP8100 via the serial interface. The serial interface employs an 8-bit shift register. Data is loaded through the serial data input, SDI. Data passing through the shift register is output through the serial data output, SDO.

The serial clock, SCK controls the serial loading process. All eight data bits are required to correctly program the amplifier. The falling edge of CS enables the shift register to receive data. The SCK signal must be high during the falling and rising edge of CS. Each data bit is clocked into the shift register on the rising edge of SCK. Data is transferred from the shift register to the holding register on the rising edge of CS. Operation is shown in the timing diagram, Figure 13.

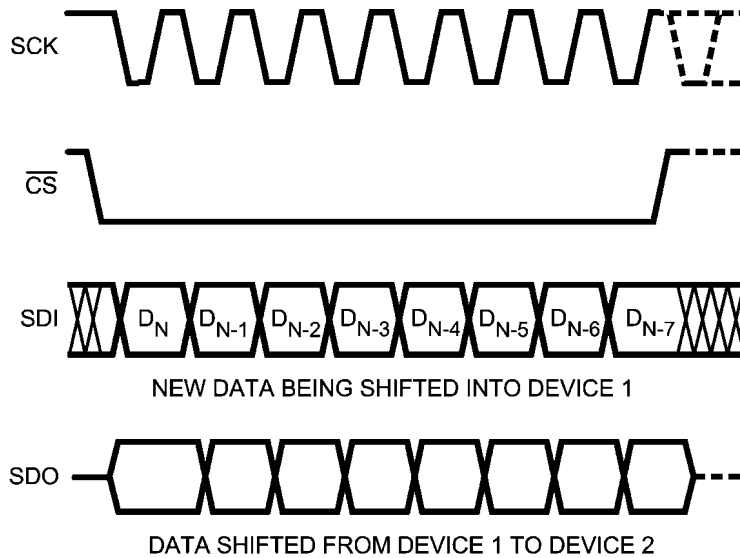

20147624

FIGURE 13. Serial Control Interface Timing

The serial control pins can be connected in one of two ways when two or more LMP8100s are used in an application.

shown in *Figure 14*. After the microcontroller writes a byte all registers will have the same value.

Star Configuration

This configuration can be used if each LMP8100 will always have the same value in each register. The connections are

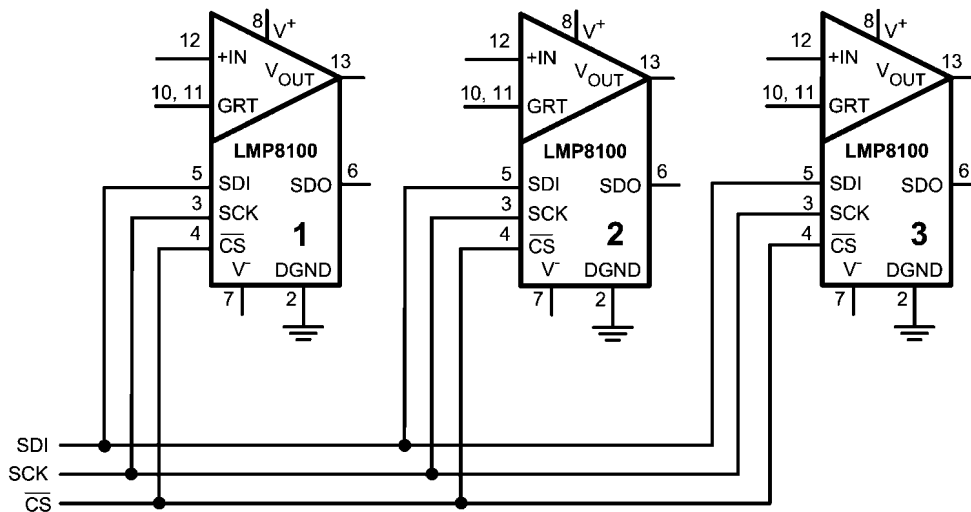

20147680

FIGURE 14. Star Configuration

Daisy Chain Configuration

This configuration can be used to program the same or different values in the register of each LMP8100. The connections are shown in *Figure 15*. In this configuration the SDO pin of each LMP8100 is connected to the SDI pin of the following LMP8100.

The following two examples show how the registers are written.

If all three LMP8100s need a gain of 11 with a compensation level of 10. (10001010)

	Register of LMP8100 #1	Register of LMP8100 #2	Register of LMP8100 #3	Notes
Power on	00000000	00000000	00000000	Default power on state (see above)
Byte one sent	10001010	00000000	00000000	The data in the register of LMP8100 #1 is shifted into the register of LMP8100 #2, the data in the register of LMP8100 #2 is shifted into the register of LMP8100 #3.
Byte two sent	10001010	10001010	00000000	
Byte three sent	10001010	10001010	10001010	

If LMP8100 #1 needs a gain of 11 with a compensation level of 10 (10001010), LMP8100 #2 needs a gain of 6 with a compensation of 00 (00000101), and LMP8100 #3 needs a gain of 2 with a compensation of 00 (00000001).

	Register of LMP8100 #1	Register of LMP8100 #2	Register of LMP8100 #3	Notes
Power on	00000000	00000000	00000000	Default power on state (see above)
Byte one sent	00000001	00000000	00000000	The data in the register of LMP8100 #1 is shifted into the register of LMP8100 #2, the data in the register of LMP8100 #2 is shifted into the register of LMP8100 #3.
Byte two sent	00000101	00000001	00000000	
Byte three sent	10001010	00000101	00000001	

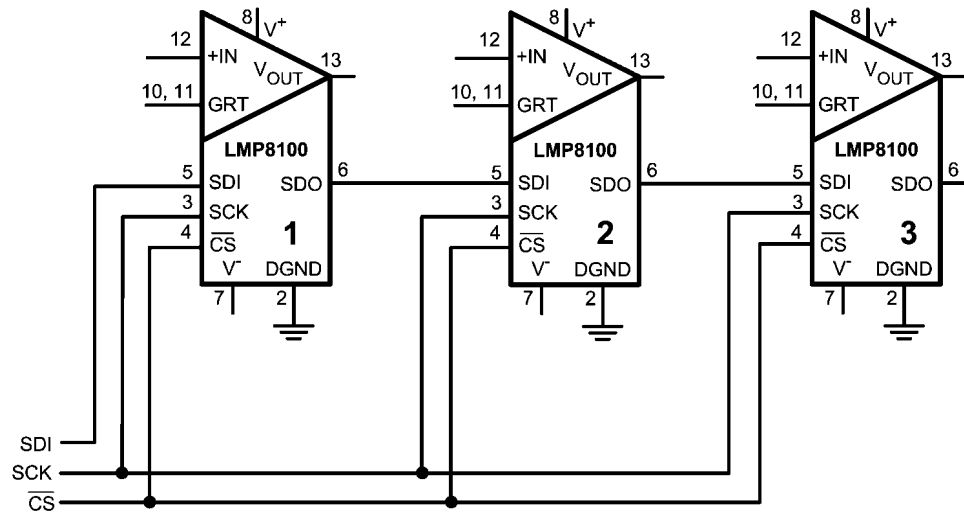

20147681

FIGURE 15. Daisy Chain Configuration

POWER SUPPLY PURITY AND BYPASSING

Particular attention to power supply purity is needed in order to preserve the LMP8100's gain accuracy and low noise. The LMP8100 worst-case PSRR is 85 dB or 56.2 $\mu\text{V}/\text{V}$. Nevertheless, the usable dynamic range, gain accuracy and inherent low noise of the amplifier can be compromised through the introduction and amplification of power supply noise.

To decouple the LMP8100 from supply line AC noise, a 0.1 μF capacitor should be located on each supply line, close to the LMP8100. Adding a 10 μF capacitor in parallel with the 0.1 μF capacitor will reduce the noise introduced to the LMP8100 even more by providing an AC path to ground for most frequency ranges.

A power supply dropout ($V^+ - V^- < 2.7\text{V}$) can cause an unintended reset of the register. If a dropout occurs, the register will need to be reprogrammed with the correct values.

SCALING AMPLIFIER

The LMP8100 is ideally suited for use as an amplifier between a sensor that has a wide output range and an ADC. As the signal from the sensor changes the gain of the LMP8100 can be changed so that the entire input range of the ADC is being used at all times. Figure 16 shows a data acquisition system using the LMP8100 and the ADC121S101. The 100 Ω resistor and 390 pF capacitor form an antialiasing filter for the ADC121S101. The capacitor also stores and delivers charge to the switched capacitor input of the ADC. The capacitive load on the LMP8100 created by the 390pF capacitor is decreased by the 100 Ω resistor.

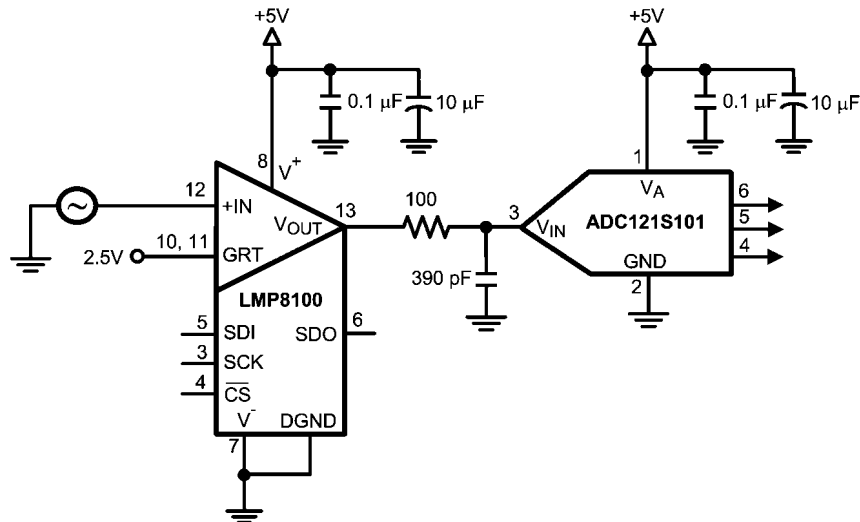

20147682

FIGURE 16. Data Acquisition System Using the LMP8100

BRIDGE AMPLIFIER

In Figure 17 two LMP8100s are used with a LMP7711 to build an amplifier for the signal from a GMR Magnetic Field Sensor. The advantage of using the LMP8100 is that as the signal strength from the Magnetic Field Sensor decreases, the gain of the LMP8100 can be increased. An example is if the signal from this composite amplifier is used to drive an ADC. When the maximum magnetic field to be measured is applied, the gain of the LMP7711 can be set to supply a full range signal to the ADC input with the gain of the LMP8100 set to one. As the magnetic field decreases, the gain of the LMP8100 can be increased, so that the signal supplied to the ADC uses a maximum amount of the ADC input range.

The following can be done to maximize performance:

- Connect the GRT pins directly together and to GND with a low impedance trace.

- Make the traces between the Magnetic Field Sensor and the LMP8100s short to minimize noise pickup.
- Place 0.1 μF capacitors close to each of the LMP8100 supply pins.

The following can be done to simplify the design:

- Connect the SCL, SCK, and $\overline{\text{CS}}$ lines in parallel and one microcontroller can be used to drive both LMP8100s.
- The SDO pin can be left floating.

The LM317 and LM6171 are used for the supply of the Magnetic Sensor. The 100 Ω potentiometer is used to adjust the supply voltage to the Magnetic Field Sensor. The 2 k Ω potentiometer is used to fine tune the negative supply to set the Magnetic Field Sensor output to zero.

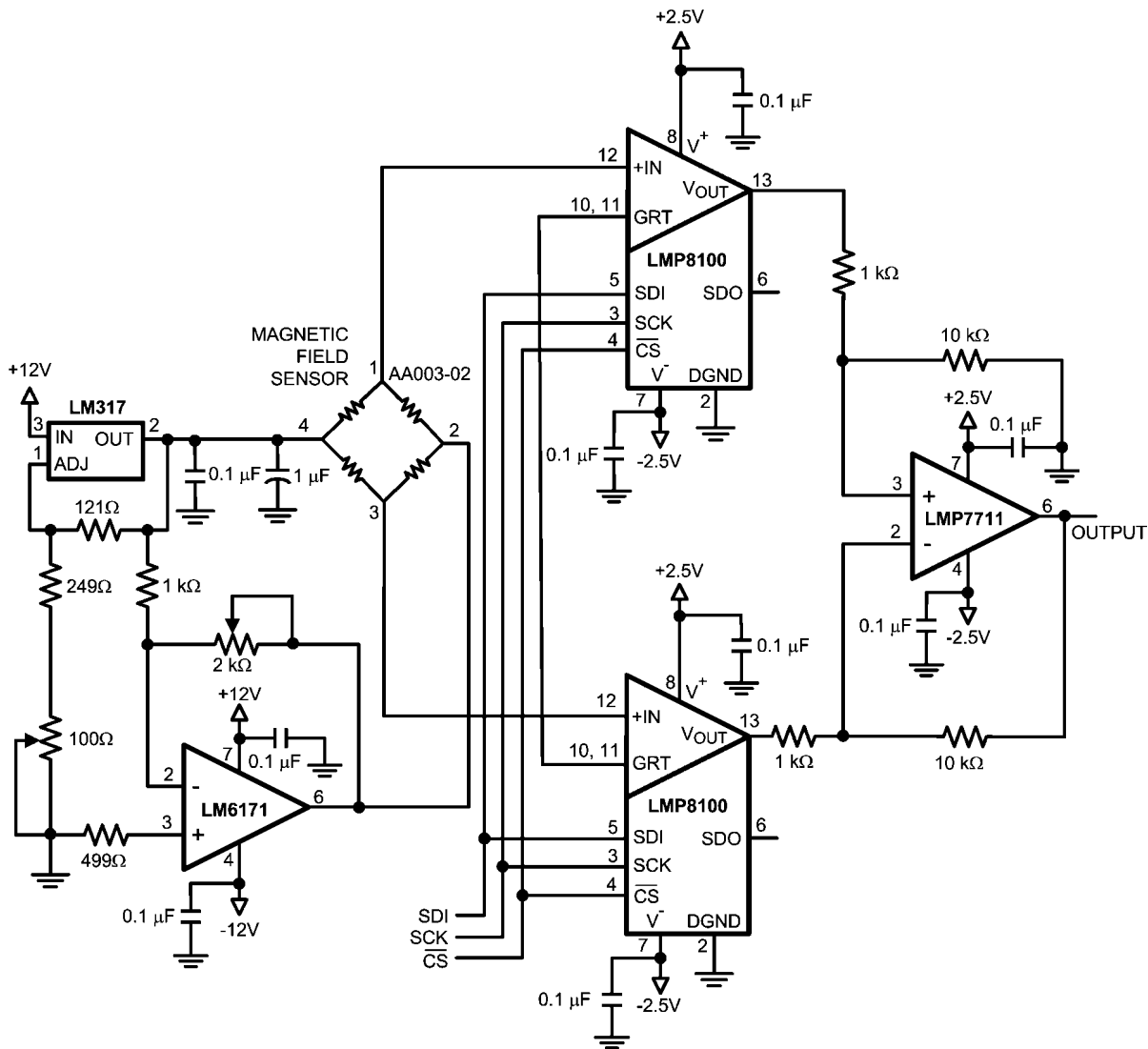

20147625

FIGURE 17. Bridge Amplifier

Physical Dimensions inches (millimeters) unless otherwise noted

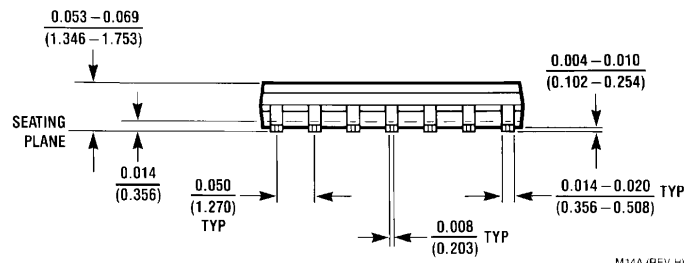
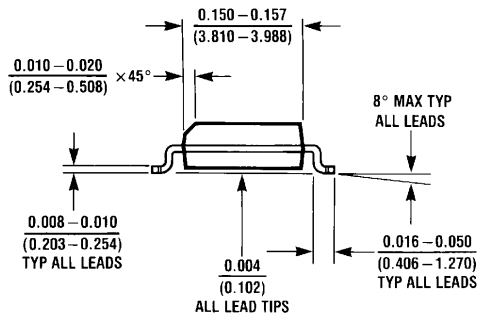
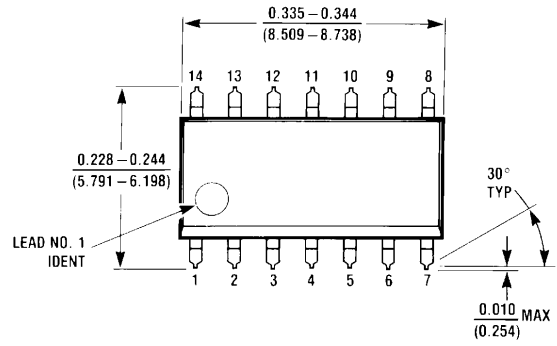

14-Pin SOIC
NS Package Number M14A

M14A (REV H)

Notes

LMP8100

Notes

For more National Semiconductor product information and proven design tools, visit the following Web sites at:

Products		Design Support	
Amplifiers	www.national.com/amplifiers	WEBENCH	www.national.com/webench
Audio	www.national.com/audio	Analog University	www.national.com/AU
Clock Conditioners	www.national.com/timing	App Notes	www.national.com/appnotes
Data Converters	www.national.com/adc	Distributors	www.national.com/contacts
Displays	www.national.com/displays	Green Compliance	www.national.com/quality/green
Ethernet	www.national.com/ethernet	Packaging	www.national.com/packaging
Interface	www.national.com/interface	Quality and Reliability	www.national.com/quality
LVDS	www.national.com/lvds	Reference Designs	www.national.com/refdesigns
Power Management	www.national.com/power	Feedback	www.national.com/feedback
Switching Regulators	www.national.com/switchers		
LDOs	www.national.com/ldo		
LED Lighting	www.national.com/led		
PowerWise	www.national.com/powerwise		
Serial Digital Interface (SDI)	www.national.com/sdi		
Temperature Sensors	www.national.com/tempsensors		
Wireless (PLL/VCO)	www.national.com/wireless		

THE CONTENTS OF THIS DOCUMENT ARE PROVIDED IN CONNECTION WITH NATIONAL SEMICONDUCTOR CORPORATION ("NATIONAL") PRODUCTS. NATIONAL MAKES NO REPRESENTATIONS OR WARRANTIES WITH RESPECT TO THE ACCURACY OR COMPLETENESS OF THE CONTENTS OF THIS PUBLICATION AND RESERVES THE RIGHT TO MAKE CHANGES TO SPECIFICATIONS AND PRODUCT DESCRIPTIONS AT ANY TIME WITHOUT NOTICE. NO LICENSE, WHETHER EXPRESS, IMPLIED, ARISING BY ESTOPPEL OR OTHERWISE, TO ANY INTELLECTUAL PROPERTY RIGHTS IS GRANTED BY THIS DOCUMENT.

TESTING AND OTHER QUALITY CONTROLS ARE USED TO THE EXTENT NATIONAL DEEMS NECESSARY TO SUPPORT NATIONAL'S PRODUCT WARRANTY. EXCEPT WHERE MANDATED BY GOVERNMENT REQUIREMENTS, TESTING OF ALL PARAMETERS OF EACH PRODUCT IS NOT NECESSARILY PERFORMED. NATIONAL ASSUMES NO LIABILITY FOR APPLICATIONS ASSISTANCE OR BUYER PRODUCT DESIGN. BUYERS ARE RESPONSIBLE FOR THEIR PRODUCTS AND APPLICATIONS USING NATIONAL COMPONENTS. PRIOR TO USING OR DISTRIBUTING ANY PRODUCTS THAT INCLUDE NATIONAL COMPONENTS, BUYERS SHOULD PROVIDE ADEQUATE DESIGN, TESTING AND OPERATING SAFEGUARDS.

EXCEPT AS PROVIDED IN NATIONAL'S TERMS AND CONDITIONS OF SALE FOR SUCH PRODUCTS, NATIONAL ASSUMES NO LIABILITY WHATSOEVER, AND NATIONAL DISCLAIMS ANY EXPRESS OR IMPLIED WARRANTY RELATING TO THE SALE AND/OR USE OF NATIONAL PRODUCTS INCLUDING LIABILITY OR WARRANTIES RELATING TO FITNESS FOR A PARTICULAR PURPOSE, MERCHANTABILITY, OR INFRINGEMENT OF ANY PATENT, COPYRIGHT OR OTHER INTELLECTUAL PROPERTY RIGHT.

LIFE SUPPORT POLICY

NATIONAL'S PRODUCTS ARE NOT AUTHORIZED FOR USE AS CRITICAL COMPONENTS IN LIFE SUPPORT DEVICES OR SYSTEMS WITHOUT THE EXPRESS PRIOR WRITTEN APPROVAL OF THE CHIEF EXECUTIVE OFFICER AND GENERAL COUNSEL OF NATIONAL SEMICONDUCTOR CORPORATION. As used herein:

Life support devices or systems are devices which (a) are intended for surgical implant into the body, or (b) support or sustain life and whose failure to perform when properly used in accordance with instructions for use provided in the labeling can be reasonably expected to result in a significant injury to the user. A critical component is any component in a life support device or system whose failure to perform can be reasonably expected to cause the failure of the life support device or system or to affect its safety or effectiveness.

National Semiconductor and the National Semiconductor logo are registered trademarks of National Semiconductor Corporation. All other brand or product names may be trademarks or registered trademarks of their respective holders.

Copyright© 2008 National Semiconductor Corporation

For the most current product information visit us at www.national.com



**National Semiconductor
Americas Technical
Support Center**
Email:
new.feedback@nsc.com
Tel: 1-800-272-9959

**National Semiconductor Europe
Technical Support Center**
Email: europe.support@nsc.com
German Tel: +49 (0) 180 5010 771
English Tel: +44 (0) 870 850 4288

**National Semiconductor Asia
Pacific Technical Support Center**
Email: ap.support@nsc.com

**National Semiconductor Japan
Technical Support Center**
Email: jpn.feedback@nsc.com