

LME49720

Dual High Performance, High Fidelity Audio Operational Amplifier

General Description

The LME49720 is part of the ultra-low distortion, low noise, high slew rate operational amplifier series optimized and fully specified for high performance, high fidelity applications. Combining advanced leading-edge process technology with state-of-the-art circuit design, the LME49720 audio operational amplifiers deliver superior audio signal amplification for outstanding audio performance. The LME49720 combines extremely low voltage noise density ($2.7\text{nV}/\sqrt{\text{Hz}}$) with vanishingly low THD+N (0.00003%) to easily satisfy the most demanding audio applications. To ensure that the most challenging loads are driven without compromise, the LME49720 has a high slew rate of $\pm 20\text{V}/\mu\text{s}$ and an output current capability of $\pm 26\text{mA}$. Further, dynamic range is maximized by an output stage that drives $2\text{k}\Omega$ loads to within 1V of either power supply voltage and to within 1.4V when driving 600Ω loads.

The LME49720's outstanding CMRR (120dB), PSRR (120dB), and V_{OS} (0.1mV) give the amplifier excellent operational amplifier DC performance.

The LME49720 has a wide supply range of $\pm 2.5\text{V}$ to $\pm 17\text{V}$. Over this supply range the LME49720's input circuitry maintains excellent common-mode and power supply rejection, as well as maintaining its low input bias current. The LME49720 is unity gain stable. This Audio Operational Amplifier achieves outstanding AC performance while driving complex loads with values as high as 100pF.

The LME49720 is available in 8-lead narrow body SOIC, 8-lead Plastic DIP, and 8-lead Metal Can TO-99. Demonstration boards are available for each package.

Key Specifications

- Power Supply Voltage Range $\pm 2.5\text{V}$ to $\pm 17\text{V}$
- THD+N ($A_V = 1$, $V_{\text{OUT}} = 3V_{\text{RMS}}$, $f_{\text{IN}} = 1\text{kHz}$)

$R_L = 2\text{k}\Omega$	0.00003% (typ)
$R_L = 600\Omega$	0.00003% (typ)
■ Input Noise Density	$2.7\text{nV}/\sqrt{\text{Hz}}$ (typ)
■ Slew Rate	$\pm 20\text{V}/\mu\text{s}$ (typ)
■ Gain Bandwidth Product	55MHz (typ)
■ Open Loop Gain ($R_L = 600\Omega$)	140dB (typ)
■ Input Bias Current	10nA (typ)
■ Input Offset Voltage	0.1mV (typ)
■ DC Gain Linearity Error	0.000009%

Features

- Easily drives 600Ω loads
- Optimized for superior audio signal fidelity
- Output short circuit protection
- PSRR and CMRR exceed 120dB (typ)
- SOIC, DIP, TO-99 metal can packages

Applications

- Ultra high quality audio amplification
- High fidelity preamplifiers
- High fidelity multimedia
- State of the art phono pre amps
- High performance professional audio
- High fidelity equalization and crossover networks
- High performance line drivers
- High performance line receivers
- High fidelity active filters

Typical Application

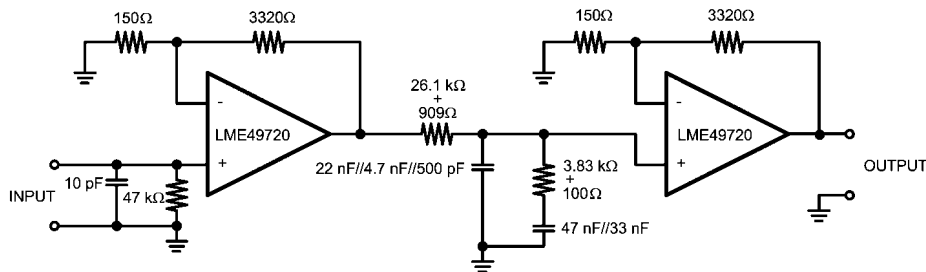

Note: 1% metal film resistors, 5% polypropylene capacitors

Passively Equalized RIAA Phono Preamplifier

300038k5

Connection Diagrams

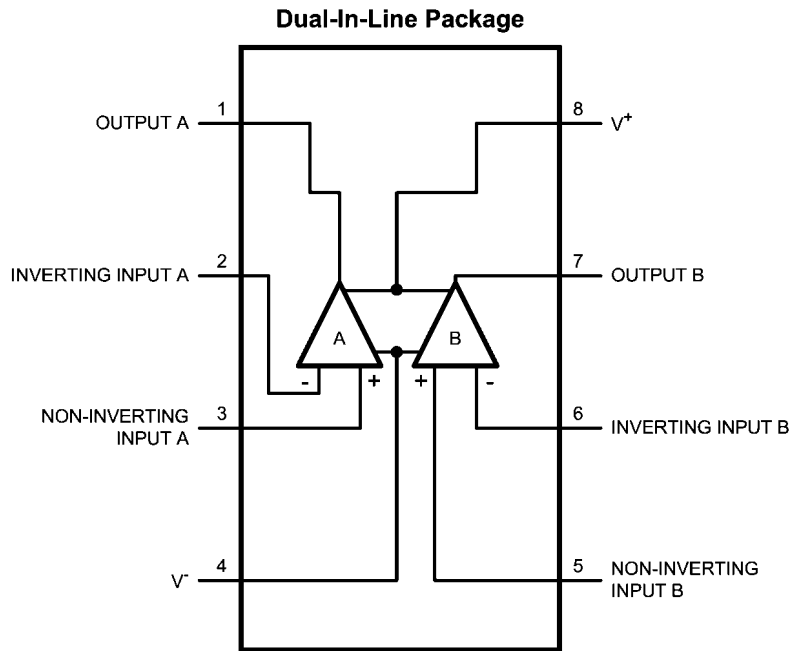

30003855

Order Number LME49720MA
See NS Package Number — M08A
Order Number LME49720NA
See NS Package Number — N08E

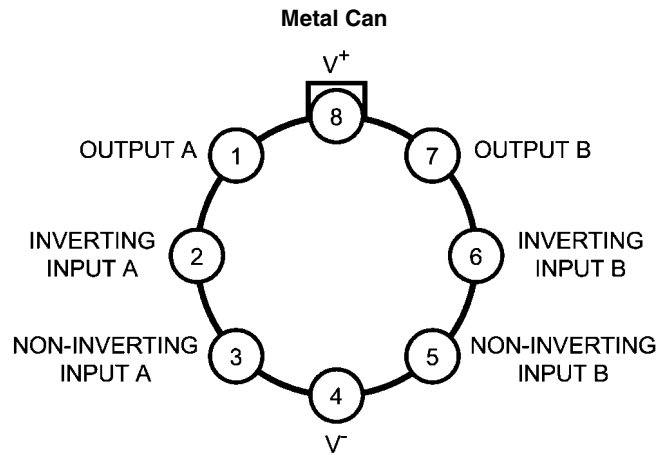

30003813

Order Number LME49720HA
See NS Package Number — H08C

Absolute Maximum Ratings (Notes 1, 2)

If Military/Aerospace specified devices are required, please contact the National Semiconductor Sales Office/ Distributors for availability and specifications.

Power Supply Voltage ($V_S = V^+ - V^-$)	36V	Pins 1, 4, 7 and 8	200V
Storage Temperature	-65°C to 150°C	Pins 2, 3, 5 and 6	100V
Input Voltage ($V^- - 0.7V$ to (V^+) + 0.7V)		Junction Temperature	150°C
Output Short Circuit (Note 3)	Continuous	Thermal Resistance	
Power Dissipation	Internally Limited	θ_{JA} (SO)	145°C/W
ESD Susceptibility (Note 4)	2000V	θ_{JA} (NA)	102°C/W
ESD Susceptibility (Note 5)		θ_{JA} (HA)	150°C/W
		θ_{JC} (HA)	35°C/W
		Temperature Range	
		$T_{MIN} \leq T_A \leq T_{MAX}$	-40°C \leq T_A \leq 85°C
		Supply Voltage Range	$\pm 2.5V \leq V_S \leq \pm 17V$

Electrical Characteristics for the LME49720 (Notes 1, 2) The following specifications apply for $V_S = \pm 15V$, $R_L = 2k\Omega$, $f_{IN} = 1kHz$, and $T_A = 25^\circ C$, unless otherwise specified.

Symbol	Parameter	Conditions	LME49720		Units (Limits)
			Typical	Limit	
			(Note 6)	(Note 7)	
THD+N	Total Harmonic Distortion + Noise	$A_V = 1$, $V_{OUT} = 3V_{rms}$ $R_L = 2k\Omega$ $R_L = 600\Omega$	0.00003 0.00003	0.00009	% (max)
IMD	Intermodulation Distortion	$A_V = 1$, $V_{OUT} = 3V_{RMS}$ Two-tone, 60Hz & 7kHz 4:1	0.00005		%
GBWP	Gain Bandwidth Product		55	45	MHz (min)
SR	Slew Rate		± 20	± 15	V/ μ s (min)
FPBW	Full Power Bandwidth	$V_{OUT} = 1V_{P-P}$, -3dB referenced to output magnitude at $f = 1kHz$	10		MHz
t_s	Settling time	$A_V = -1$, 10V step, $C_L = 100pF$ 0.1% error range	1.2		μ s
e_n	Equivalent Input Noise Voltage	$f_{BW} = 20Hz$ to 20kHz	0.34	0.65	μV_{RMS} (max)
	Equivalent Input Noise Density	$f = 1kHz$ $f = 10Hz$	2.7 6.4	4.7	nV/ \sqrt{Hz} (max)
i_n	Current Noise Density	$f = 1kHz$ $f = 10Hz$	1.6 3.1		pA/ \sqrt{Hz}
V_{OS}	Offset Voltage		± 0.1	± 0.7	mV (max)
$\Delta V_{OS}/\Delta Temp$	Average Input Offset Voltage Drift vs Temperature	-40°C \leq T_A \leq 85°C	0.2		$\mu V/^\circ C$
PSRR	Average Input Offset Voltage Shift vs Power Supply Voltage	$\Delta V_S = 20V$ (Note 8)	120	110	dB (min)
ISO_{CH-CH}	Channel-to-Channel Isolation	$f_{IN} = 1kHz$	118		dB
		$f_{IN} = 20kHz$	112		
I_B	Input Bias Current	$V_{CM} = 0V$	10	72	nA (max)
$\Delta I_{OS}/\Delta Temp$	Input Bias Current Drift vs Temperature	-40°C \leq T_A \leq 85°C	0.1		nA/ $^\circ C$
I_{OS}	Input Offset Current	$V_{CM} = 0V$	11	65	nA (max)
V_{IN-CM}	Common-Mode Input Voltage Range		+14.1 -13.9	(V^+) - 2.0 (V^-) + 2.0	V (min)
CMRR	Common-Mode Rejection	-10V < V_{cm} < 10V	120	110	dB (min)
Z_{IN}	Differential Input Impedance		30		k Ω
	Common Mode Input Impedance	-10V < V_{cm} < 10V	1000		M Ω

Symbol	Parameter	Conditions	LME49720		Units (Limits)
			Typical	Limit	
			(Note 6)	(Note 7)	
A _{VOL}	Open Loop Voltage Gain	-10V < V _{out} < 10V, R _L = 600Ω	140	125	dB (min)
		-10V < V _{out} < 10V, R _L = 2kΩ	140		
		-10V < V _{out} < 10V, R _L = 10kΩ	140		
V _{OUTMAX}	Maximum Output Voltage Swing	R _L = 600Ω	±13.6	±12.5	V (min)
		R _L = 2kΩ	±14.0		
		R _L = 10kΩ	±14.1		
I _{OUT}	Output Current	R _L = 600Ω, V _S = ±17V	±26	±23	mA (min)
I _{OUT-CC}	Instantaneous Short Circuit Current		+53 -42		mA
R _{OUT}	Output Impedance	f _{IN} = 10kHz Closed-Loop Open-Loop	0.01 13		Ω
C _{LOAD}	Capacitive Load Drive Overshoot	100pF	16		%
I _S	Total Quiescent Current	I _{OUT} = 0mA	10	12	mA (max)

Note 1: *Absolute Maximum Ratings* indicate limits beyond which damage to the device may occur.

Note 2: Operating Ratings indicate conditions for which the device is functional, but do not guarantee specific performance limits. For guaranteed specifications and test conditions, see the Electrical Characteristics. The guaranteed specifications apply only for the test conditions listed. Some performance characteristics may degrade when the device is not operated under the listed test conditions.

Note 3: Amplifier output connected to GND, any number of amplifiers within a package.

Note 4: Human body model, 100pF discharged through a 1.5kΩ resistor.

Note 5: Machine Model ESD test is covered by specification EIAJ IC-121-1981. A 200pF cap is charged to the specified voltage and then discharged directly into the IC with no external series resistor (resistance of discharge path must be under 50Ω).

Note 6: Typical specifications are specified at +25°C and represent the most likely parametric norm.

Note 7: Tested limits are guaranteed to National's AOQL (Average Outgoing Quality Level).

Note 8: PSRR is measured as follows: V_{OS} is measured at two supply voltages, ±5V and ±15V. PSRR = | 20log(ΔV_{OS}/ΔV_S) |.

Typical Performance Characteristics

THD+N vs Output Voltage
 $V_{CC} = 15V, V_{EE} = -15V$
 $R_L = 2k\Omega$

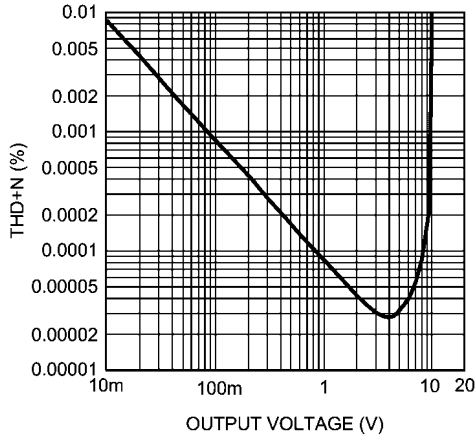

300038k6

THD+N vs Output Voltage
 $V_{CC} = 12V, V_{EE} = -12V$
 $R_L = 2k\Omega$

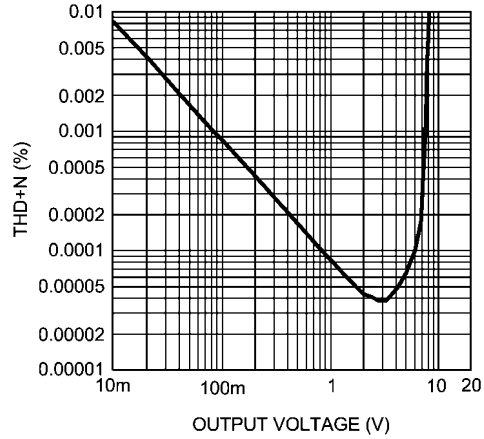

300038k7

THD+N vs Output Voltage
 $V_{CC} = 17V, V_{EE} = -17V$
 $R_L = 2k\Omega$

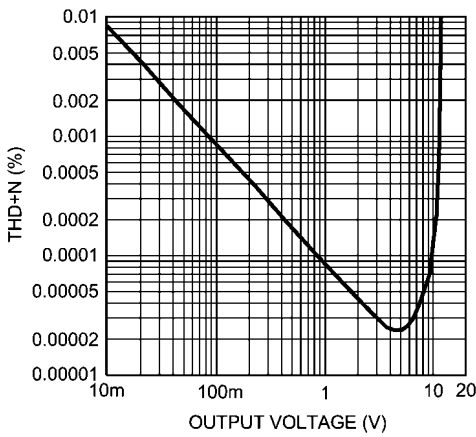

300038k8

THD+N vs Output Voltage
 $V_{CC} = 2.5V, V_{EE} = -2.5V$
 $R_L = 2k\Omega$

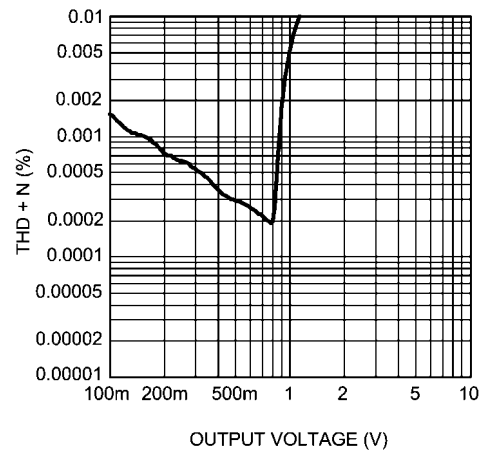

300038i4

THD+N vs Output Voltage
 $V_{CC} = 15V, V_{EE} = -15V$
 $R_L = 600\Omega$

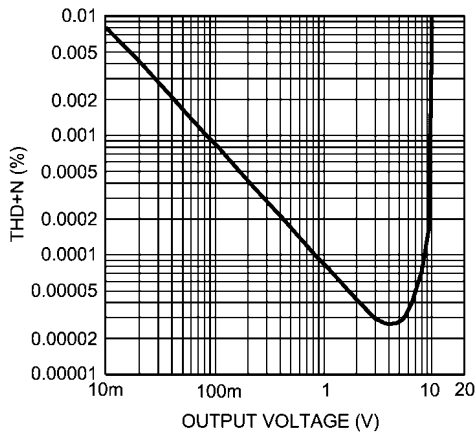

300038k9

THD+N vs Output Voltage
 $V_{CC} = 12V, V_{EE} = -12V$
 $R_L = 600\Omega$

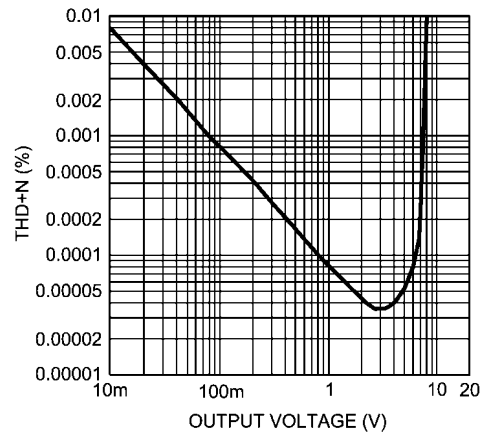

300038i0

THD+N vs Output Voltage
 $V_{CC} = 17V, V_{EE} = -17V$
 $R_L = 600\Omega$

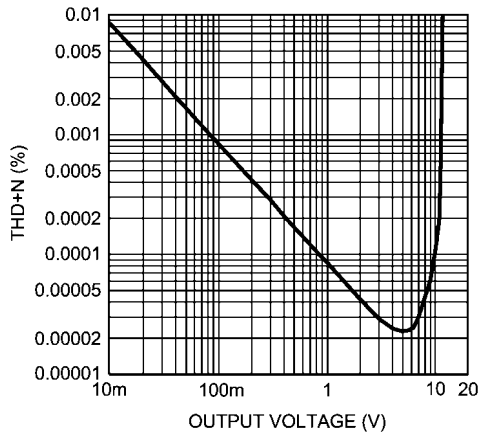

30003811

THD+N vs Output Voltage
 $V_{CC} = 2.5V, V_{EE} = -2.5V$
 $R_L = 600\Omega$

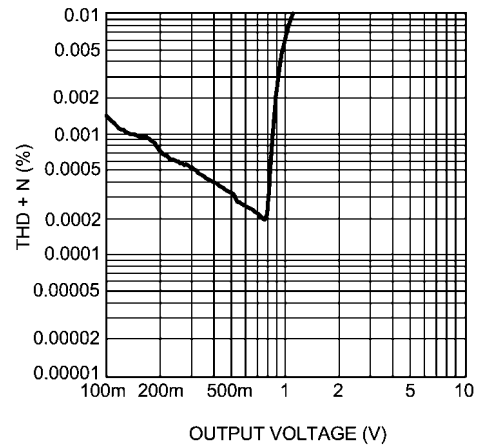

30003816

THD+N vs Output Voltage
 $V_{CC} = 15V, V_{EE} = -15V$
 $R_L = 10k\Omega$

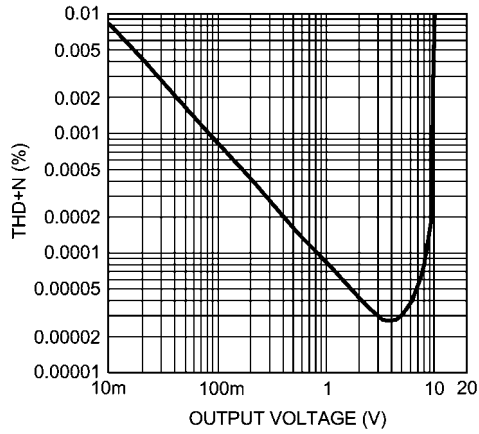

30003812

THD+N vs Output Voltage
 $V_{CC} = 12V, V_{EE} = -12V$
 $R_L = 10k\Omega$

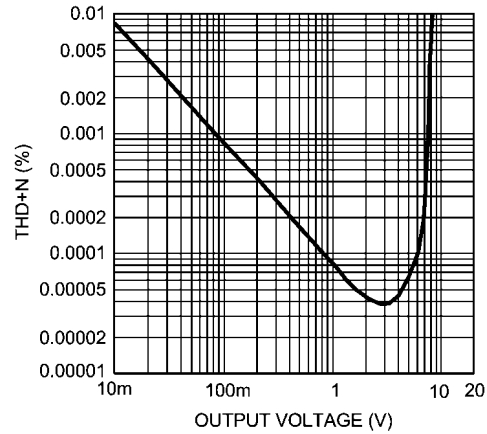

30003813

THD+N vs Output Voltage
 $V_{CC} = 17V, V_{EE} = -17V$
 $R_L = 10k\Omega$

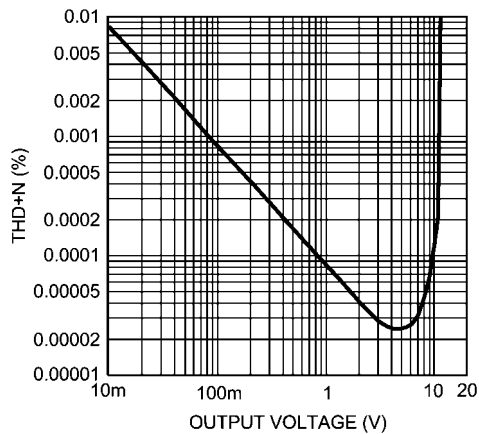

30003814

THD+N vs Output Voltage
 $V_{CC} = 2.5V, V_{EE} = -2.5V$
 $R_L = 10k\Omega$

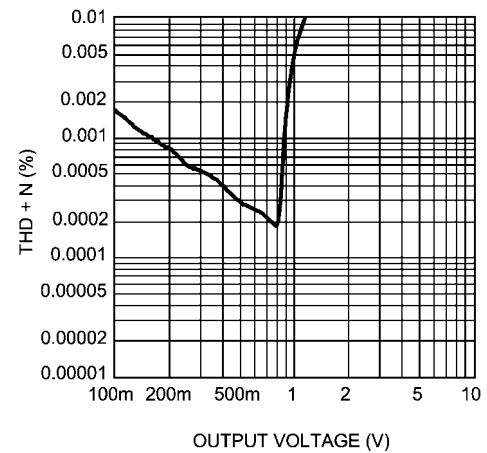

30003815

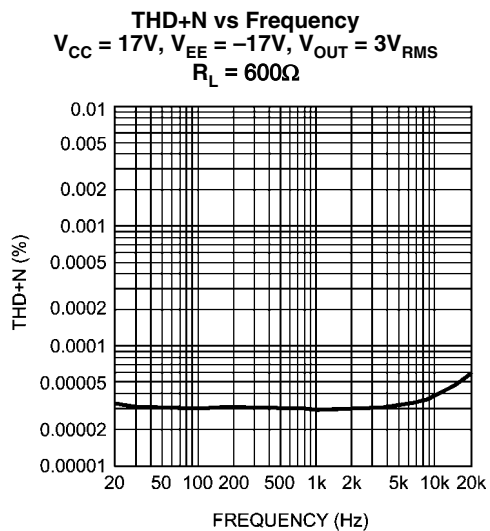
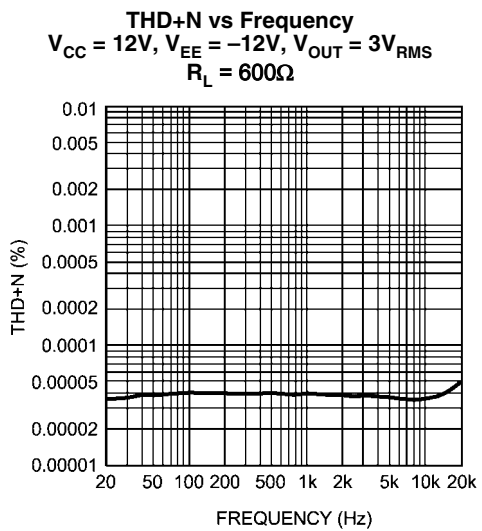
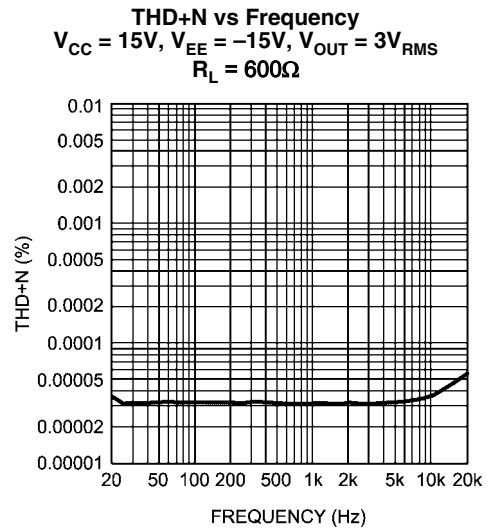
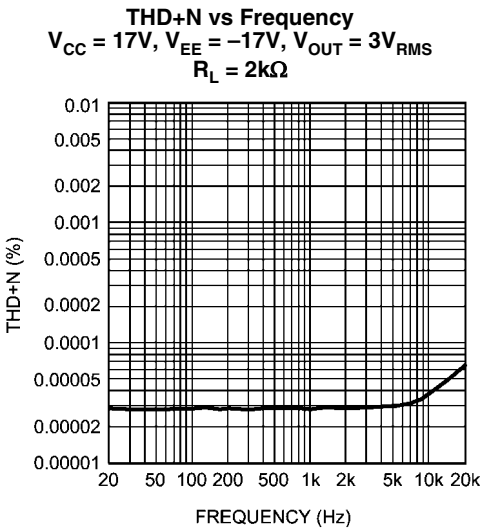
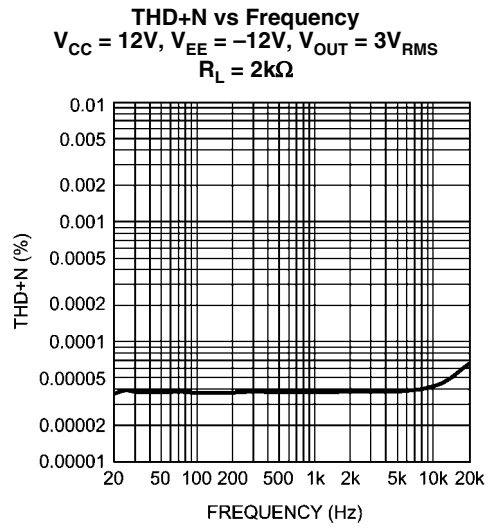
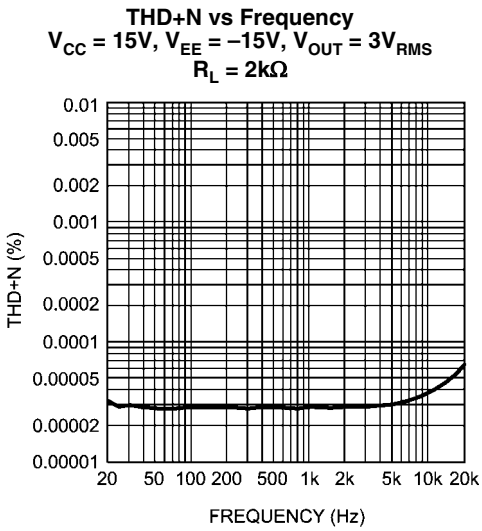

THD+N vs Frequency
 $V_{CC} = 15V, V_{EE} = -15V, V_{OUT} = 3V_{RMS}$
 $R_L = 10k\Omega$

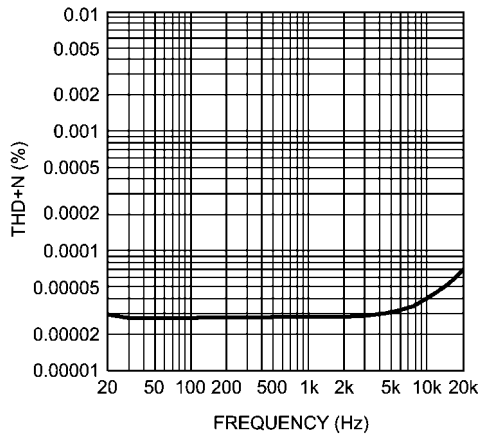

30003867

THD+N vs Frequency
 $V_{CC} = 12V, V_{EE} = -12V, V_{OUT} = 3V_{RMS}$
 $R_L = 10k\Omega$

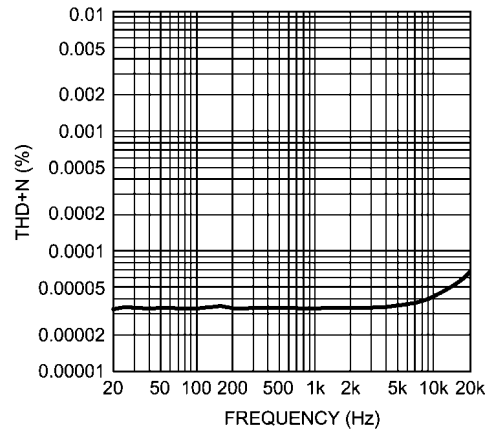

30003866

THD+N vs Frequency
 $V_{CC} = 17V, V_{EE} = -17V, V_{OUT} = 3V_{RMS}$
 $R_L = 10k\Omega$

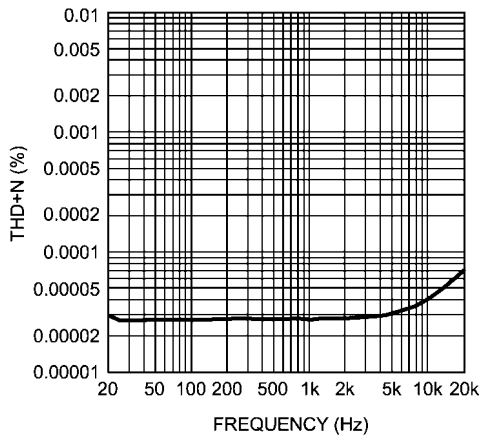

30003868

IMD vs Output Voltage
 $V_{CC} = 15V, V_{EE} = -15V$
 $R_L = 2k\Omega$

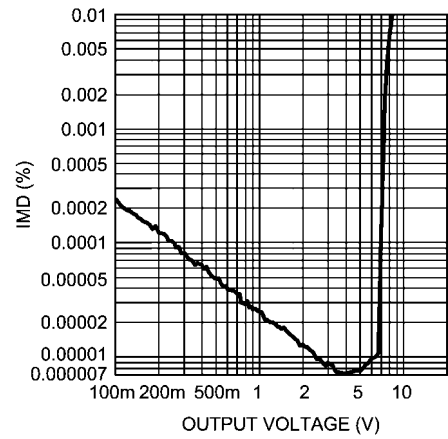

300038e6

IMD vs Output Voltage
 $V_{CC} = 12V, V_{EE} = -12V$
 $R_L = 2k\Omega$

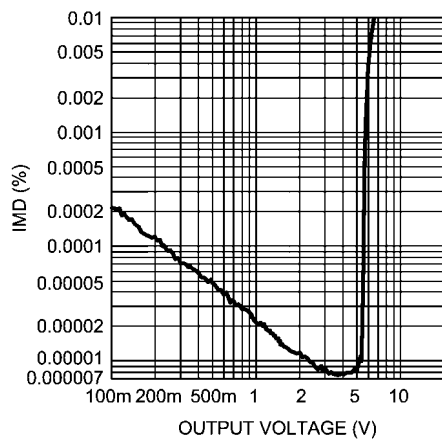

300038e5

IMD vs Output Voltage
 $V_{CC} = 2.5V, V_{EE} = -2.5V$
 $R_L = 2k\Omega$

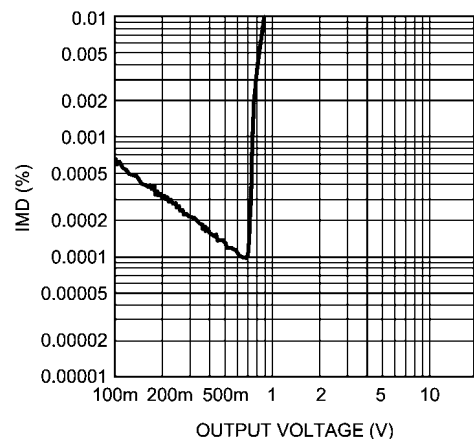

300038e4

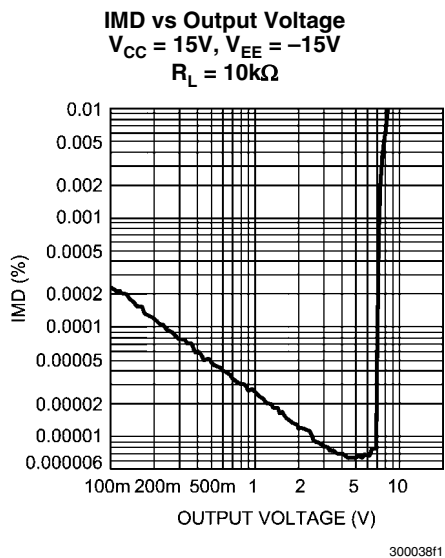
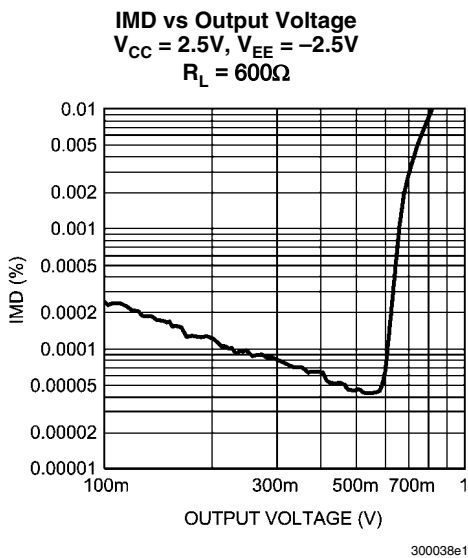
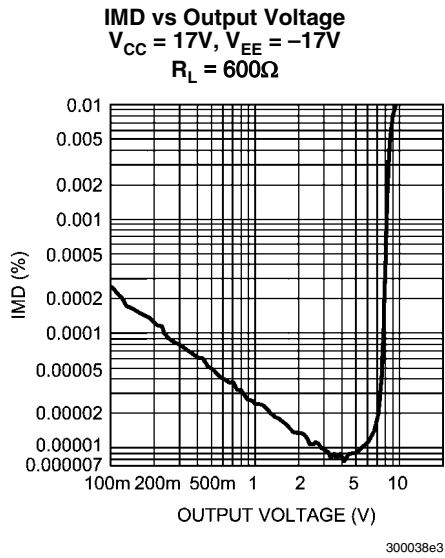
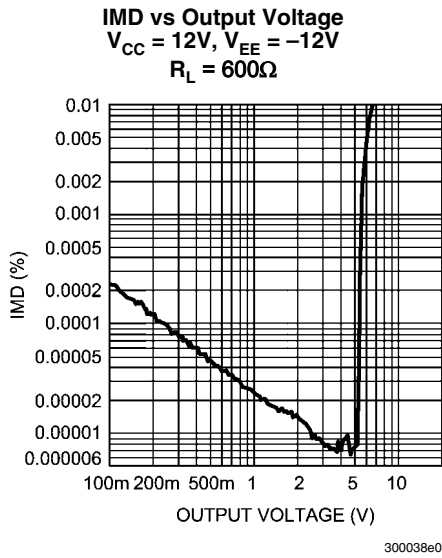
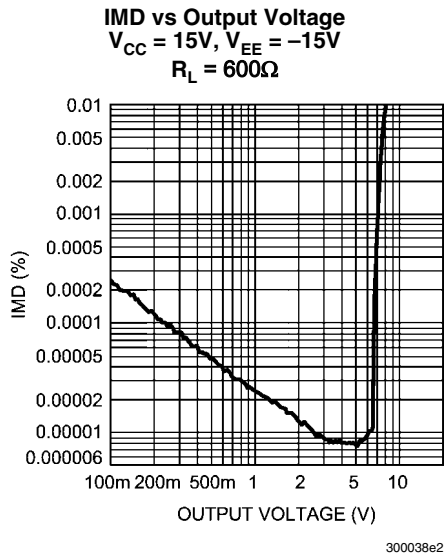
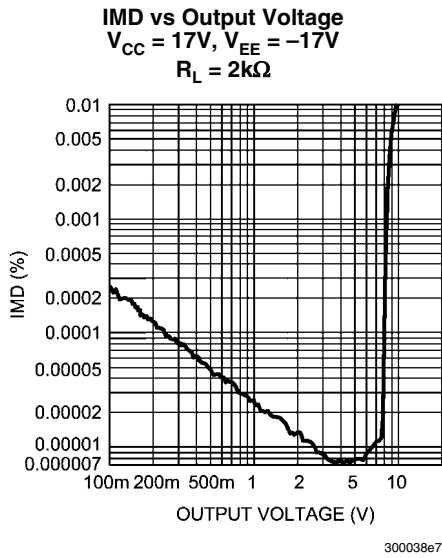

IMD vs Output Voltage
 $V_{CC} = 12V, V_{EE} = -12V$
 $R_L = 10k\Omega$

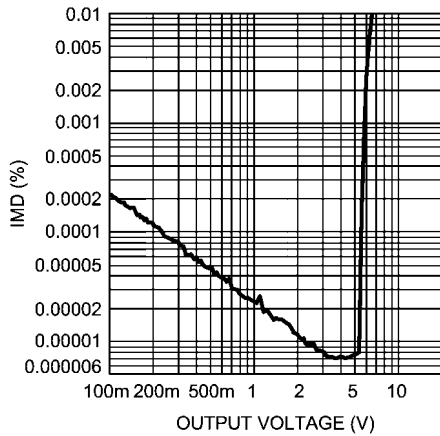

300038f0

IMD vs Output Voltage
 $V_{CC} = 17V, V_{EE} = -17V$
 $R_L = 10k\Omega$

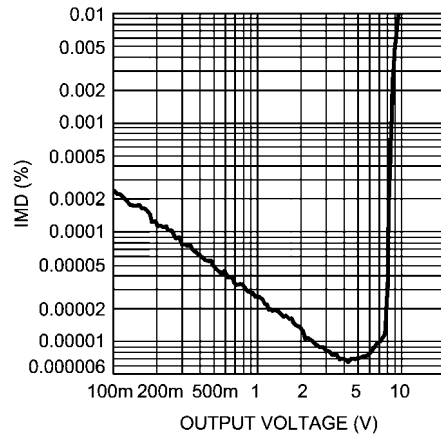

300038f2

IMD vs Output Voltage
 $V_{CC} = 2.5V, V_{EE} = -2.5V$
 $R_L = 10k\Omega$

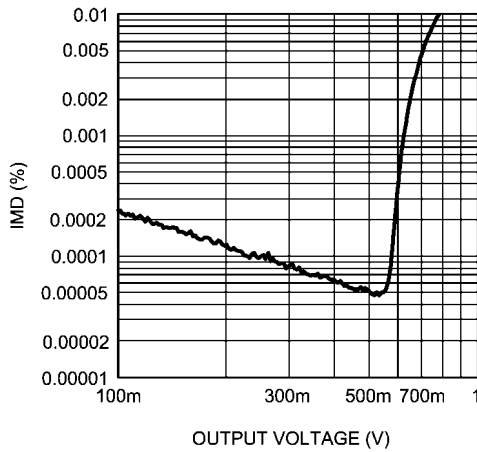

300038i6

Voltage Noise Density vs Frequency

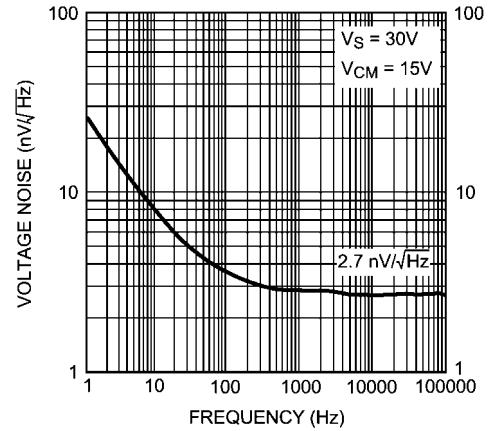

300038h6

Current Noise Density vs Frequency

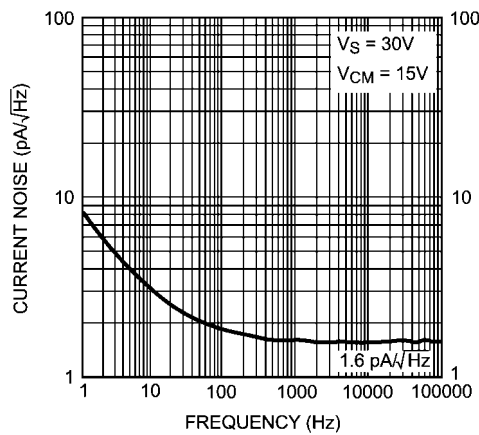

300038h7

Crosstalk vs Frequency
 $V_{CC} = 15V, V_{EE} = -15V, V_{OUT} = 3V_{RMS}$
 $A_V = 0dB, R_L = 2k\Omega$

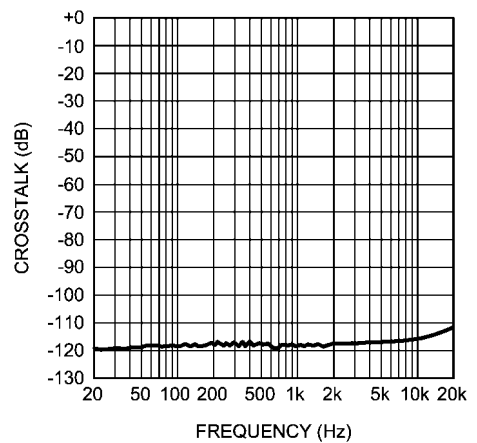

300038c8

Crosstalk vs Frequency
 $V_{CC} = 15V, V_{EE} = -15V, V_{OUT} = 10V_{RMS}$
 $A_V = 0dB, R_L = 2k\Omega$

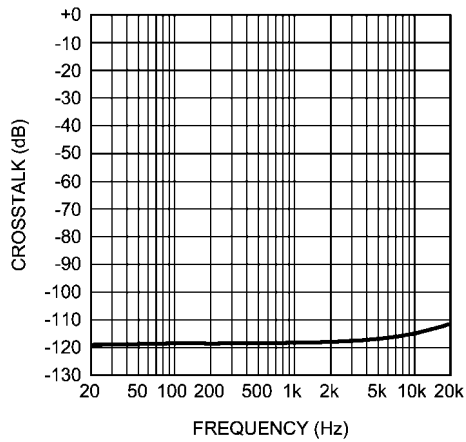

300038c9

Crosstalk vs Frequency
 $V_{CC} = 12V, V_{EE} = -12V, V_{OUT} = 3V_{RMS}$
 $A_V = 0dB, R_L = 2k\Omega$

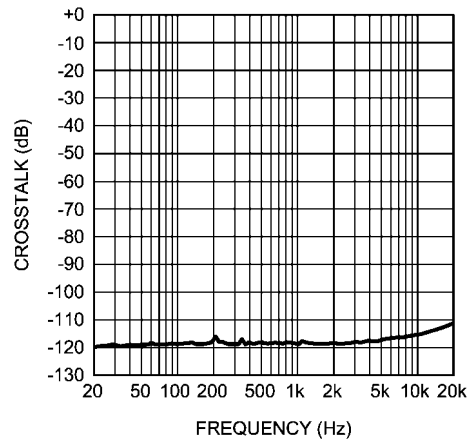

300038c6

Crosstalk vs Frequency
 $V_{CC} = 12V, V_{EE} = -12V, V_{OUT} = 10V_{RMS}$
 $A_V = 0dB, R_L = 2k\Omega$

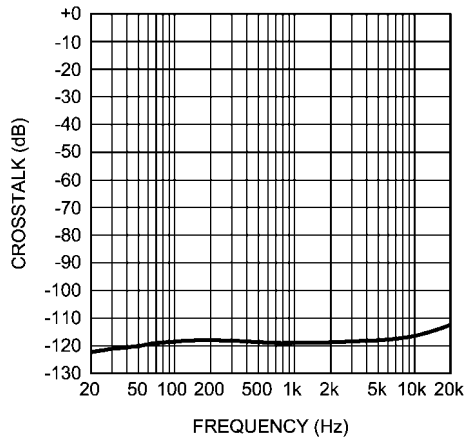

300038c7

Crosstalk vs Frequency
 $V_{CC} = 17V, V_{EE} = -17V, V_{OUT} = 3V_{RMS}$
 $A_V = 0dB, R_L = 2k\Omega$

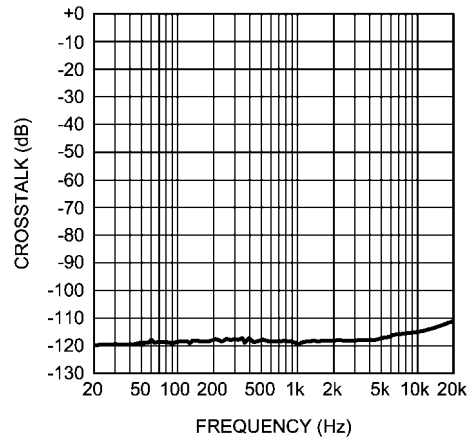

300038d0

Crosstalk vs Frequency
 $V_{CC} = 17V, V_{EE} = -17V, V_{OUT} = 10V_{RMS}$
 $A_V = 0dB, R_L = 2k\Omega$

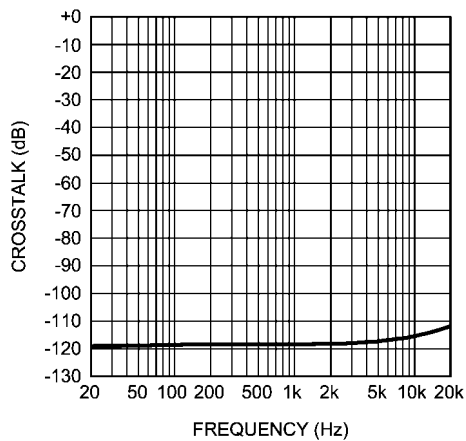

300038d1

Crosstalk vs Frequency
 $V_{CC} = 2.5V, V_{EE} = -2.5V, V_{OUT} = 1V_{RMS}$
 $A_V = 0dB, R_L = 2k\Omega$

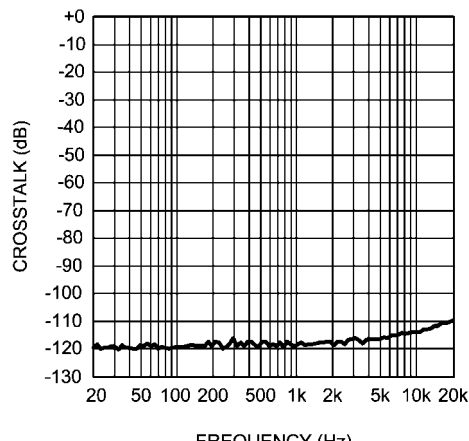

300038n8

Crosstalk vs Frequency
 $V_{CC} = 15V, V_{EE} = -15V, V_{OUT} = 3V_{RMS}$
 $A_V = 0dB, R_L = 600\Omega$

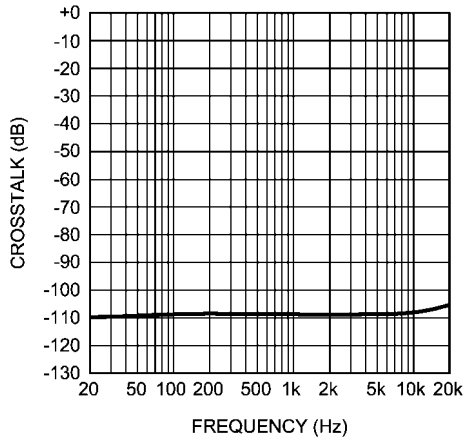

300038d6

Crosstalk vs Frequency
 $V_{CC} = 15V, V_{EE} = -15V, V_{OUT} = 10V_{RMS}$
 $A_V = 0dB, R_L = 600\Omega$

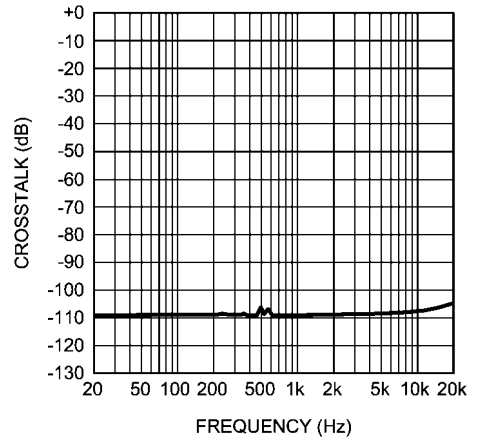

300038d7

Crosstalk vs Frequency
 $V_{CC} = 12V, V_{EE} = -12V, V_{OUT} = 3V_{RMS}$
 $A_V = 0dB, R_L = 600\Omega$

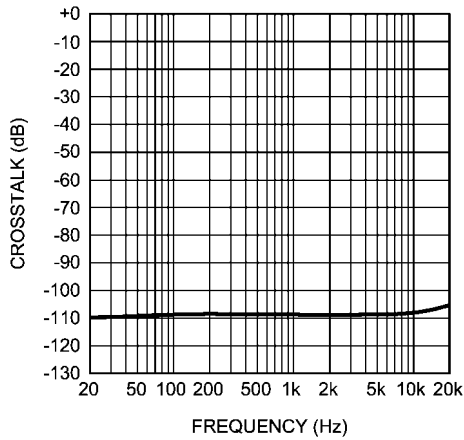

300038d4

Crosstalk vs Frequency
 $V_{CC} = 12V, V_{EE} = -12V, V_{OUT} = 10V_{RMS}$
 $A_V = 0dB, R_L = 600\Omega$

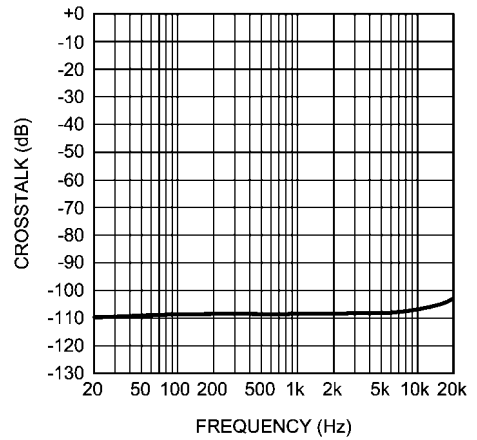

300038d5

Crosstalk vs Frequency
 $V_{CC} = 17V, V_{EE} = -17V, V_{OUT} = 3V_{RMS}$
 $A_V = 0dB, R_L = 600\Omega$

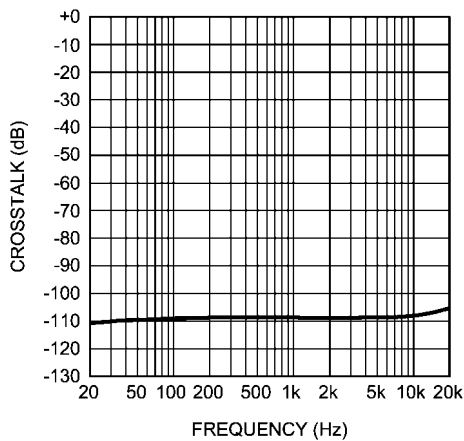

300038d8

Crosstalk vs Frequency
 $V_{CC} = 17V, V_{EE} = -17V, V_{OUT} = 10V_{RMS}$
 $A_V = 0dB, R_L = 600\Omega$

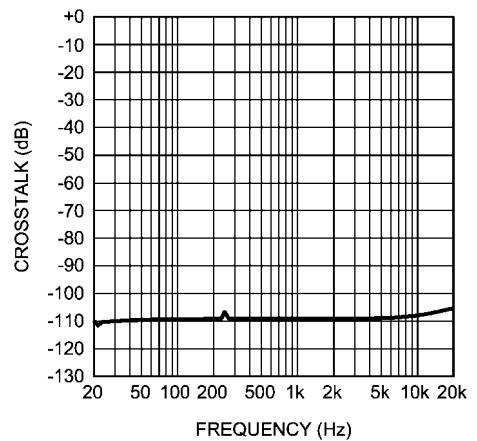

300038d9

Crosstalk vs Frequency
 $V_{CC} = 2.5V, V_{EE} = -2.5V, V_{OUT} = 1V_{RMS}$
 $A_V = 0dB, R_L = 600\Omega$

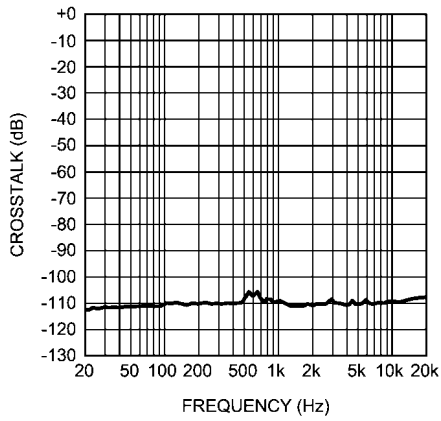

300038d2

Crosstalk vs Frequency
 $V_{CC} = 15V, V_{EE} = -15V, V_{OUT} = 3V_{RMS}$
 $A_V = 0dB, R_L = 10k\Omega$

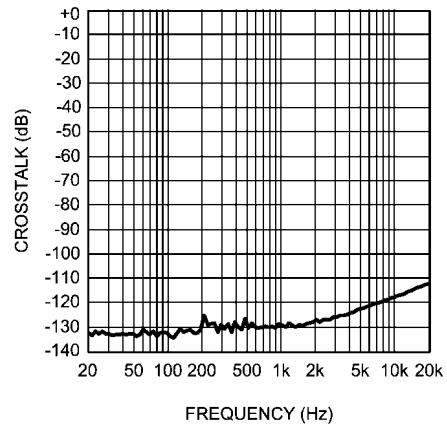

30003800

Crosstalk vs Frequency
 $V_{CC} = 15V, V_{EE} = -15V, V_{OUT} = 10V_{RMS}$
 $A_V = 0dB, R_L = 10k\Omega$

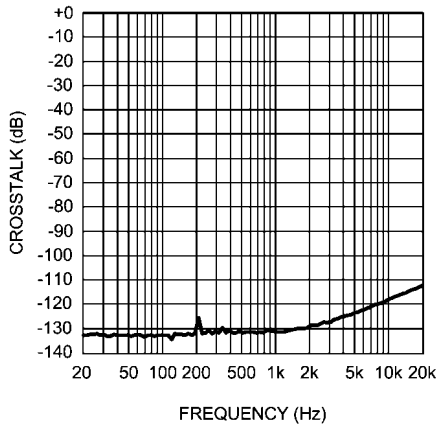

300038n7

Crosstalk vs Frequency
 $V_{CC} = 12V, V_{EE} = -12V, V_{OUT} = 3V_{RMS}$
 $A_V = 0dB, R_L = 10k\Omega$

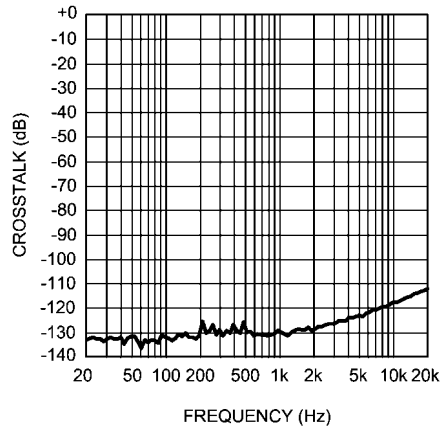

300038n9

Crosstalk vs Frequency
 $V_{CC} = 12V, V_{EE} = -12V, V_{OUT} = 10V_{RMS}$
 $A_V = 0dB, R_L = 10k\Omega$

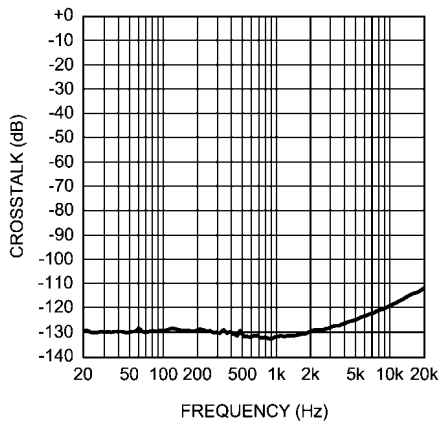

300038n6

Crosstalk vs Frequency
 $V_{CC} = 17V, V_{EE} = -17V, V_{OUT} = 3V_{RMS}$
 $A_V = 0dB, R_L = 10k\Omega$

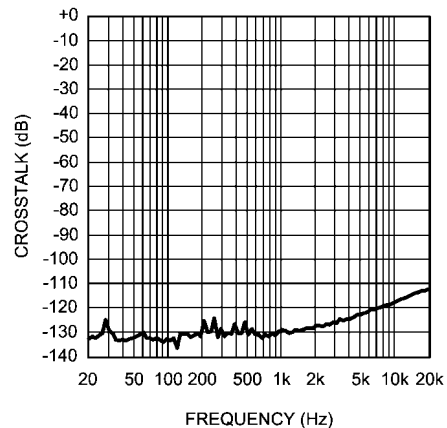

300038n5

Crosstalk vs Frequency
 $V_{CC} = 17V, V_{EE} = -17V, V_{OUT} = 10V_{RMS}$
 $A_V = 0dB, R_L = 10k\Omega$

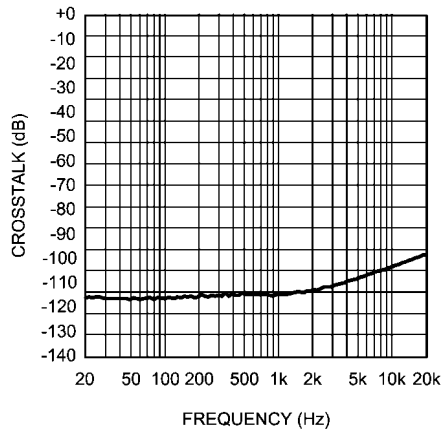

300038n3

Crosstalk vs Frequency
 $V_{CC} = 2.5V, V_{EE} = -2.5V, V_{OUT} = 1V_{RMS}$
 $A_V = 0dB, R_L = 10k\Omega$

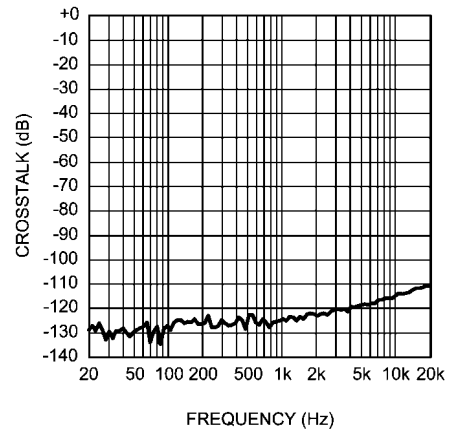

300038n4

PSRR+ vs Frequency
 $V_{CC} = 15V, V_{EE} = -15V$
 $R_L = 10k\Omega, f = 200kHz, V_{RIPPLE} = 200mVpp$

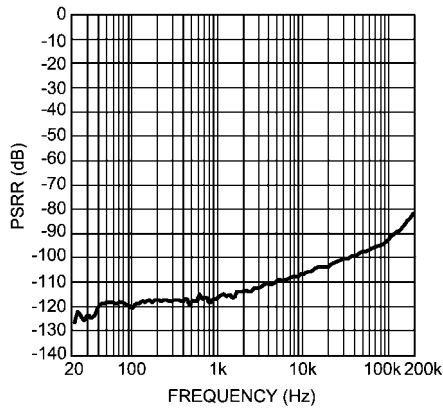

300038p2

PSRR- vs Frequency
 $V_{CC} = 15V, V_{EE} = -15V$
 $R_L = 10k\Omega, f = 200kHz, V_{RIPPLE} = 200mVpp$

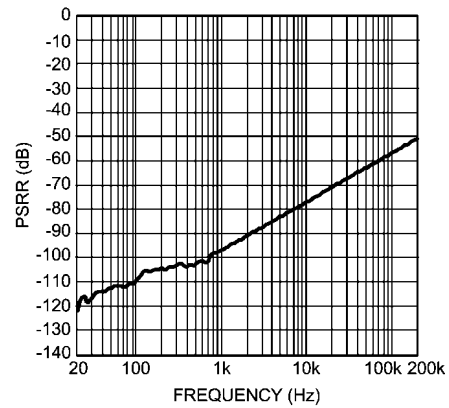

300038p5

PSRR+ vs Frequency
 $V_{CC} = 15V, V_{EE} = -15V$
 $R_L = 2k\Omega, f = 200kHz, V_{RIPPLE} = 200mVpp$

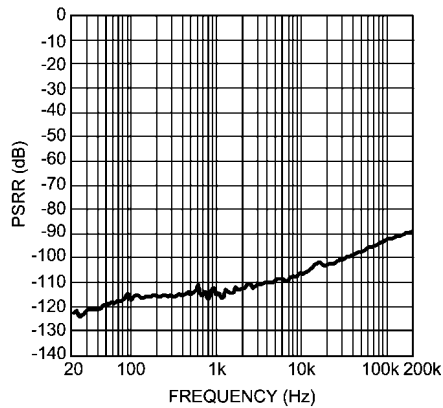

300038p3

PSRR- vs Frequency
 $V_{CC} = 15V, V_{EE} = -15V$
 $R_L = 2k\Omega, f = 200kHz, V_{RIPPLE} = 200mVpp$

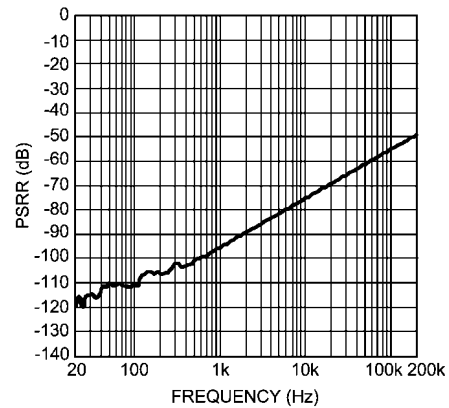

300038p6

PSRR+ vs Frequency
 $V_{CC} = 15V, V_{EE} = -15V$
 $R_L = 600\Omega, f = 200kHz, V_{RIPPLE} = 200mVpp$

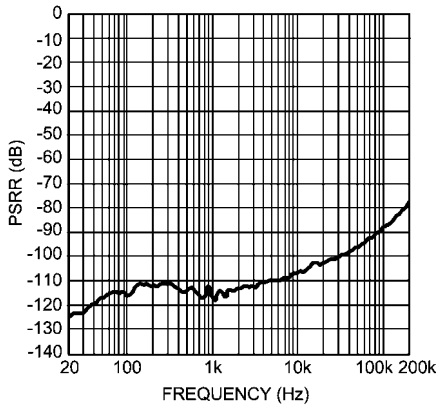

300038p1

PSRR- vs Frequency
 $V_{CC} = 15V, V_{EE} = -15V$
 $R_L = 600\Omega, f = 200kHz, V_{RIPPLE} = 200mVpp$

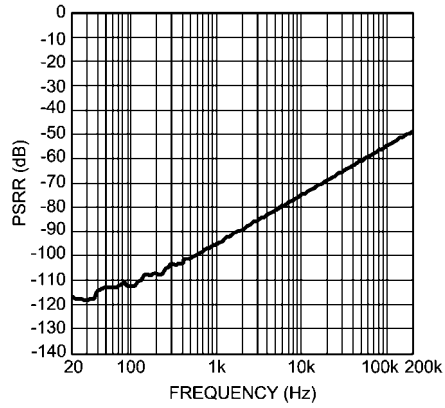

300038p4

PSRR+ vs Frequency
 $V_{CC} = 12V, V_{EE} = -12V$
 $R_L = 10k\Omega, f = 200kHz, V_{RIPPLE} = 200mVpp$

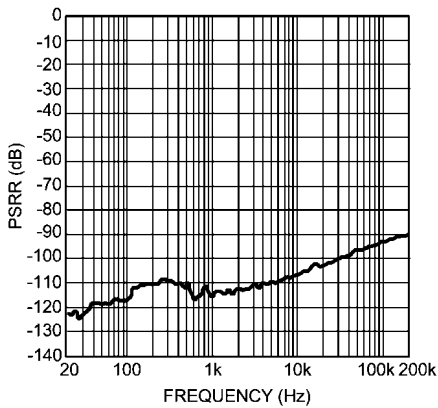

300038p8

PSRR- vs Frequency
 $V_{CC} = 12V, V_{EE} = -12V$
 $R_L = 10k\Omega, f = 200kHz, V_{RIPPLE} = 200mVpp$

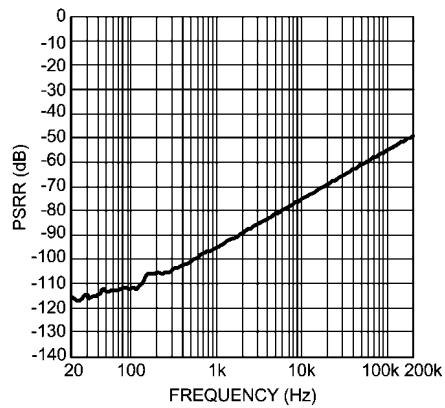

300038q1

PSRR+ vs Frequency
 $V_{CC} = 12V, V_{EE} = -12V$
 $R_L = 2k\Omega, f = 200kHz, V_{RIPPLE} = 200mVpp$

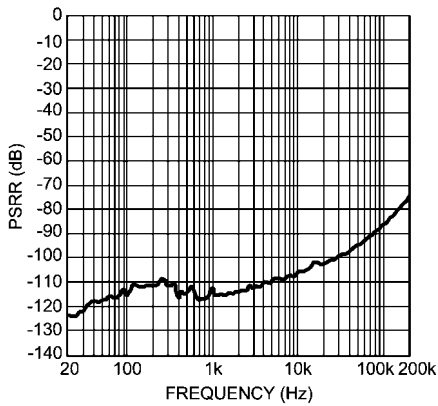

300038p9

PSRR- vs Frequency
 $V_{CC} = 12V, V_{EE} = -12V$
 $R_L = 2k\Omega, f = 200kHz, V_{RIPPLE} = 200mVpp$

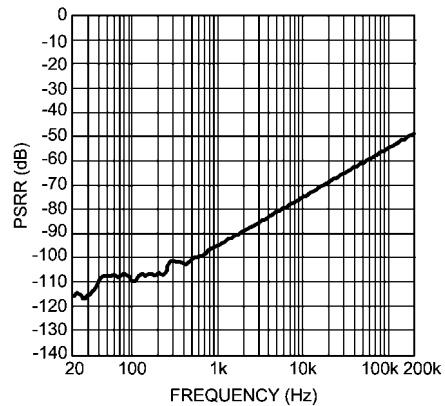

300038q2

PSRR+ vs Frequency
 $V_{CC} = 12V, V_{EE} = -12V$
 $R_L = 600\Omega, f = 200kHz, V_{RIPPLE} = 200mVpp$

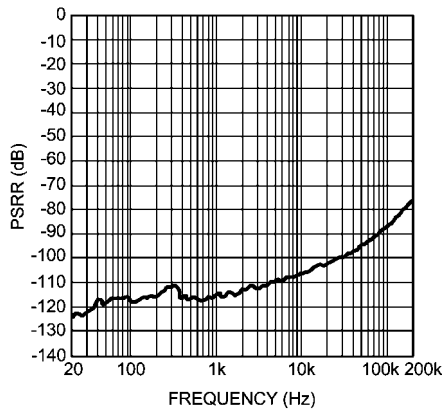

300038p7

PSRR- vs Frequency
 $V_{CC} = 12V, V_{EE} = -12V$
 $R_L = 600\Omega, f = 200kHz, V_{RIPPLE} = 200mVpp$

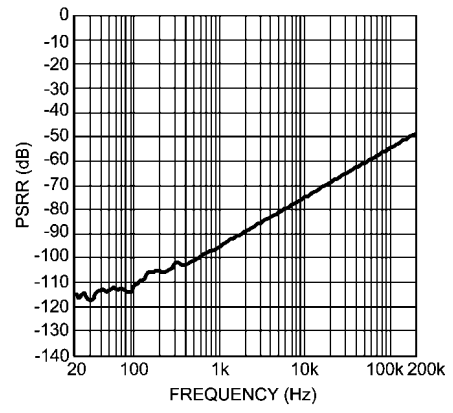

300038q0

PSRR+ vs Frequency
 $V_{CC} = 17V, V_{EE} = -17V$
 $R_L = 10k\Omega, f = 200kHz, V_{RIPPLE} = 200mVpp$

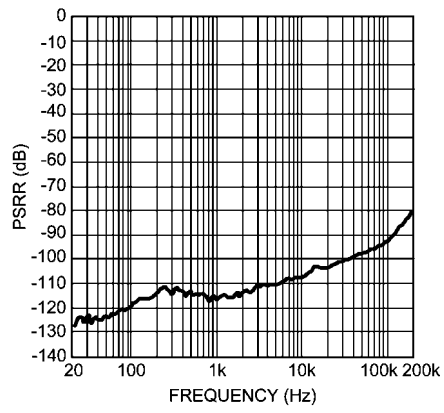

300038r0

PSRR- vs Frequency
 $V_{CC} = 17V, V_{EE} = -17V$
 $R_L = 10k\Omega, f = 200kHz, V_{RIPPLE} = 200mVpp$

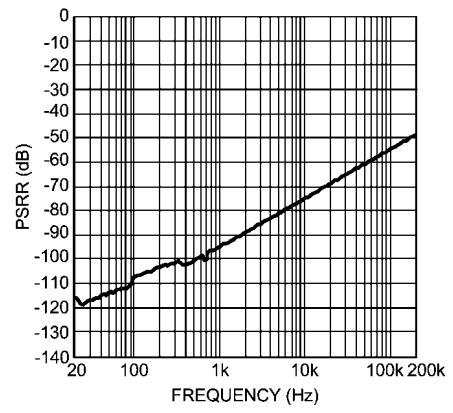

300038r3

PSRR+ vs Frequency
 $V_{CC} = 17V, V_{EE} = -17V$
 $R_L = 2k\Omega, f = 200kHz, V_{RIPPLE} = 200mVpp$

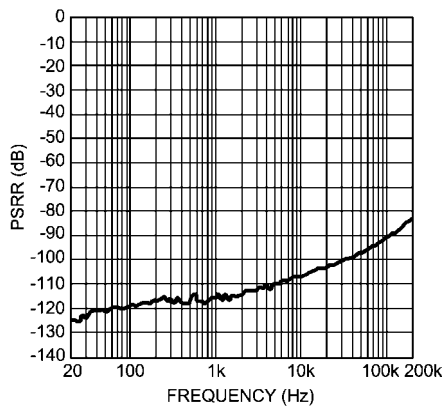

300038r1

PSRR- vs Frequency
 $V_{CC} = 17V, V_{EE} = -17V$
 $R_L = 2k\Omega, f = 200kHz, V_{RIPPLE} = 200mVpp$

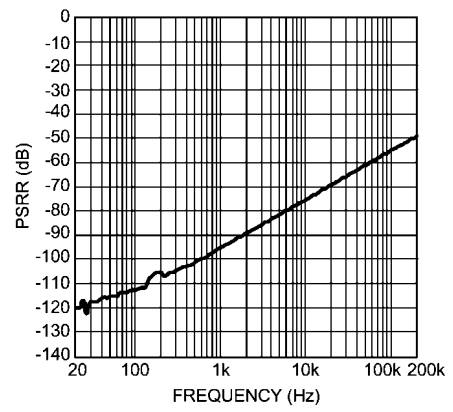

300038r4

PSRR+ vs Frequency
 $V_{CC} = 17V, V_{EE} = -17V$
 $R_L = 600\Omega, f = 200kHz, V_{RIPPLE} = 200mVpp$

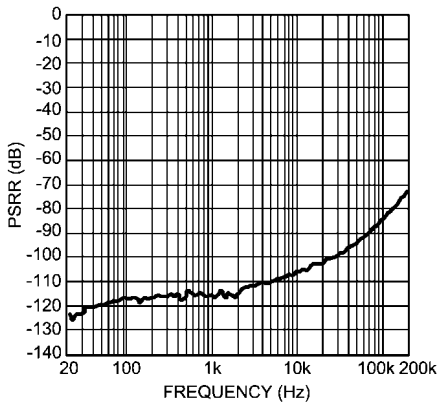

300038q9

PSRR- vs Frequency
 $V_{CC} = 17V, V_{EE} = -17V$
 $R_L = 600\Omega, f = 200kHz, V_{RIPPLE} = 200mVpp$

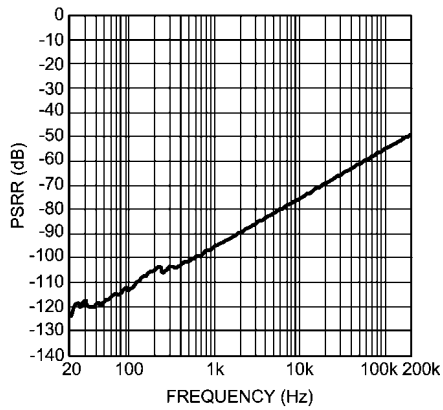

300038r2

PSRR+ vs Frequency
 $V_{CC} = 2.5V, V_{EE} = -2.5V$
 $R_L = 10k\Omega, f = 200kHz, V_{RIPPLE} = 200mVpp$

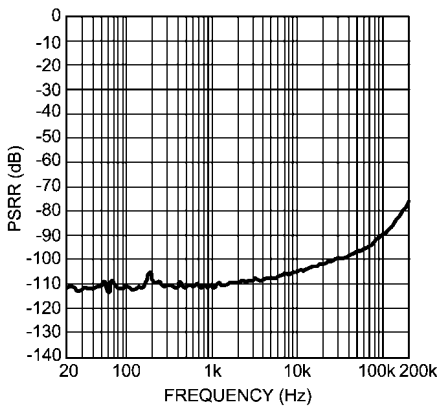

300038q4

PSRR- vs Frequency
 $V_{CC} = 2.5V, V_{EE} = -2.5V$
 $R_L = 10k\Omega, f = 200kHz, V_{RIPPLE} = 200mVpp$

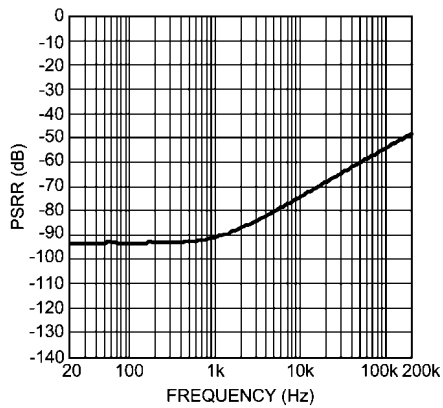

300038q7

PSRR+ vs Frequency
 $V_{CC} = 2.5V, V_{EE} = -2.5V$
 $R_L = 2k\Omega, f = 200kHz, V_{RIPPLE} = 200mVpp$

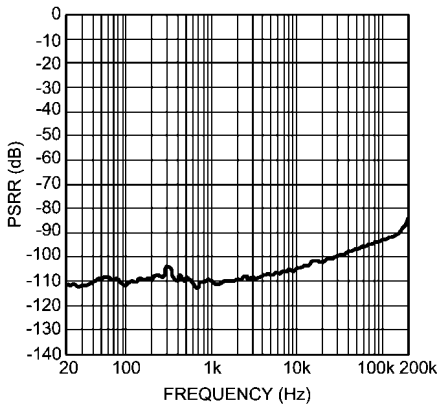

300038q5

PSRR- vs Frequency
 $V_{CC} = 2.5V, V_{EE} = -2.5V$
 $R_L = 2k\Omega, f = 200kHz, V_{RIPPLE} = 200mVpp$

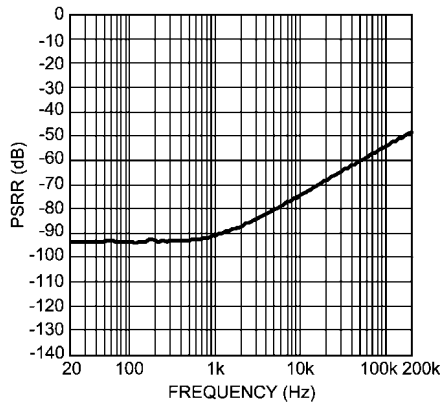

300038q8

PSRR+ vs Frequency
 $V_{CC} = 2.5V, V_{EE} = -2.5V$
 $R_L = 600\Omega, f = 200kHz, V_{RIPPLE} = 200mVpp$

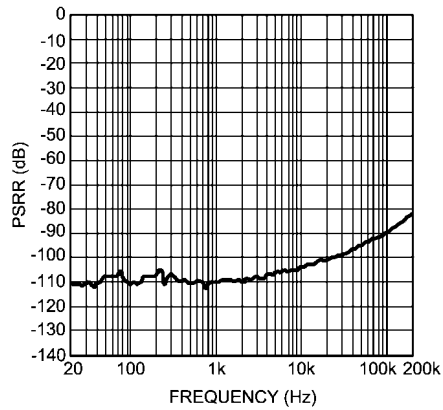

300038q3

PSRR- vs Frequency
 $V_{CC} = 2.5V, V_{EE} = -2.5V$
 $R_L = 600\Omega, f = 200kHz, V_{RIPPLE} = 200mVpp$

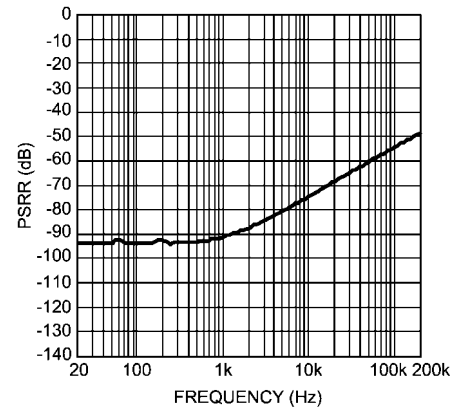

300038q6

CMRR vs Frequency
 $V_{CC} = 15V, V_{EE} = -15V$
 $R_L = 2k\Omega$

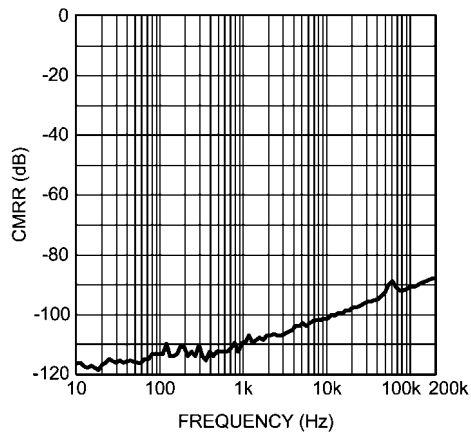

300038g0

CMRR vs Frequency
 $V_{CC} = 12V, V_{EE} = -12V$
 $R_L = 2k\Omega$

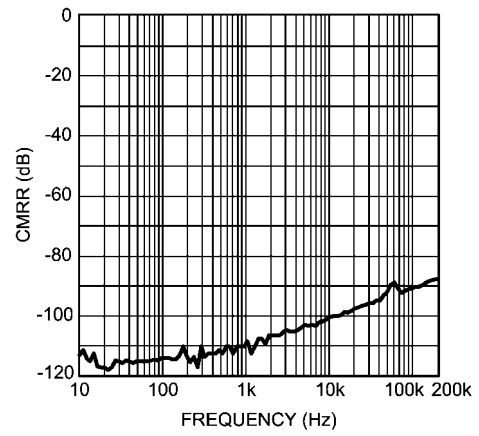

300038f7

CMRR vs Frequency
 $V_{CC} = 17V, V_{EE} = -17V$
 $R_L = 2k\Omega$

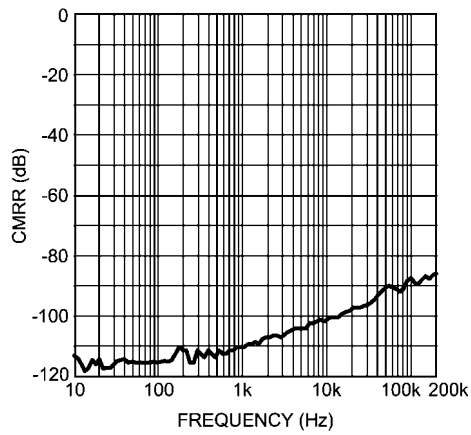

300038g3

CMRR vs Frequency
 $V_{CC} = 2.5V, V_{EE} = -2.5V$
 $R_L = 2k\Omega$

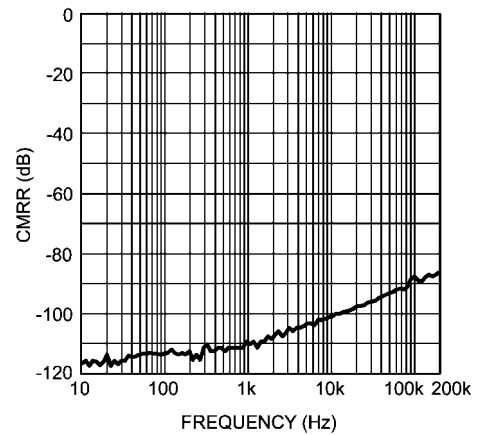

300038f4

CMRR vs Frequency
 $V_{CC} = 15V, V_{EE} = -15V$
 $R_L = 600\Omega$

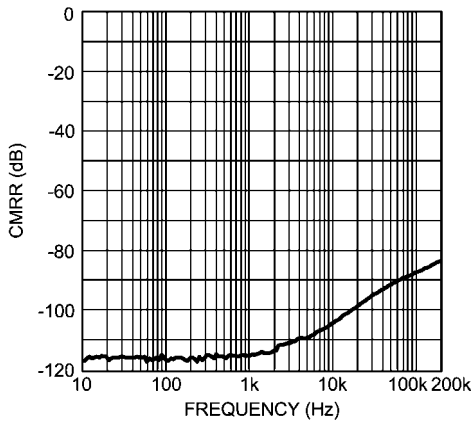

300038e9

CMRR vs Frequency
 $V_{CC} = 12V, V_{EE} = -12V$
 $R_L = 600\Omega$

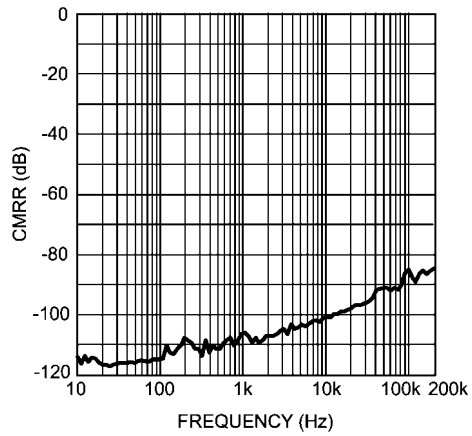

300038f9

CMRR vs Frequency
 $V_{CC} = 17V, V_{EE} = -17V$
 $R_L = 600\Omega$

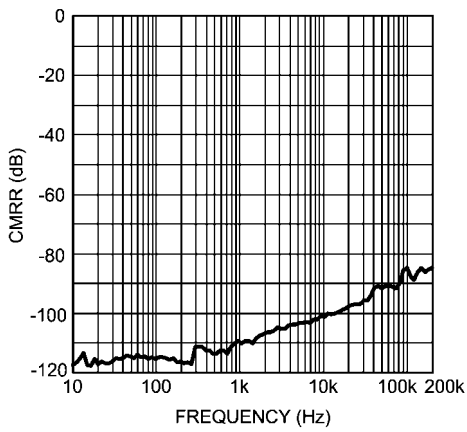

300038g5

CMRR vs Frequency
 $V_{CC} = 2.5V, V_{EE} = -2.5V$
 $R_L = 600\Omega$

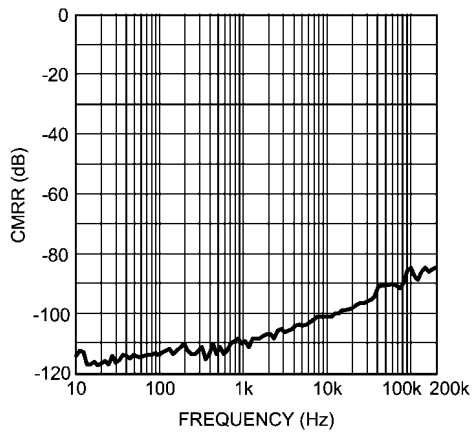

300038f6

CMRR vs Frequency
 $V_{CC} = 15V, V_{EE} = -15V$
 $R_L = 10k\Omega$

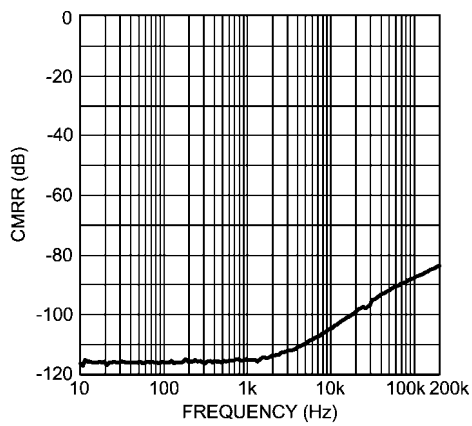

300038e8

CMRR vs Frequency
 $V_{CC} = 12V, V_{EE} = -12V$
 $R_L = 10k\Omega$

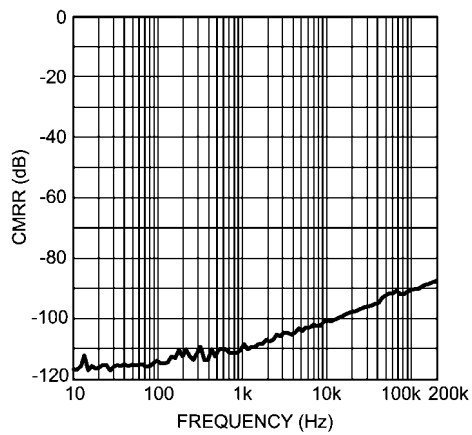

300038f8

CMRR vs Frequency
 $V_{CC} = 17V, V_{EE} = -17V$
 $R_L = 10k\Omega$

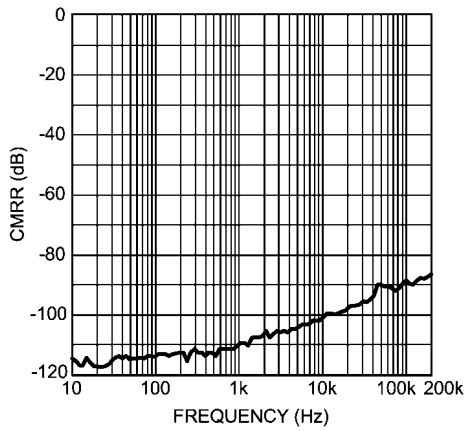

300038g4

CMRR vs Frequency
 $V_{CC} = 2.5V, V_{EE} = -2.5V$
 $R_L = 10k\Omega$

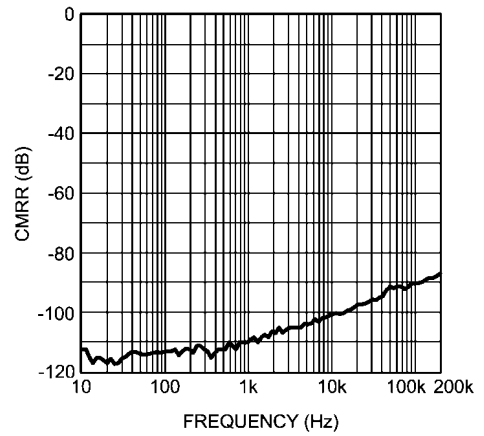

300038f5

Output Voltage vs Load Resistance
 $V_{DD} = 15V, V_{EE} = -15V$
 $THD+N = 1\%$

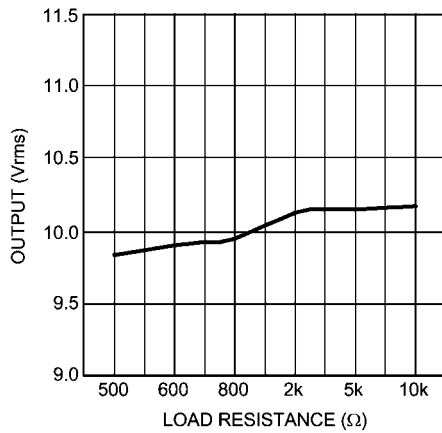

300038h1

Output Voltage vs Load Resistance
 $V_{DD} = 12V, V_{EE} = -12V$
 $THD+N = 1\%$

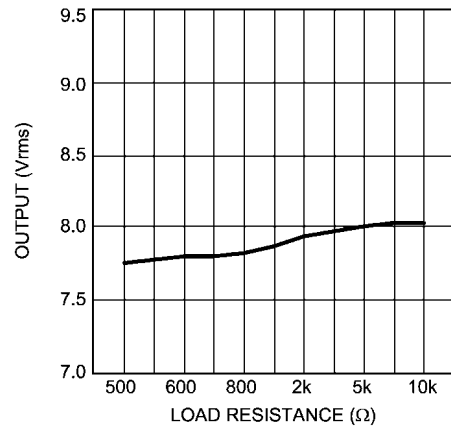

300038h0

Output Voltage vs Load Resistance
 $V_{DD} = 17V, V_{EE} = -17V$
 $THD+N = 1\%$

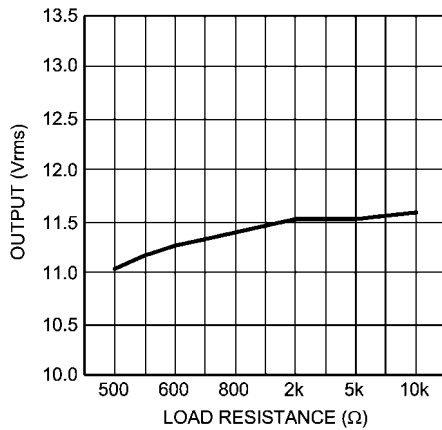

300038h2

Output Voltage vs Load Resistance
 $V_{DD} = 2.5V, V_{EE} = -2.5V$
 $THD+N = 1\%$

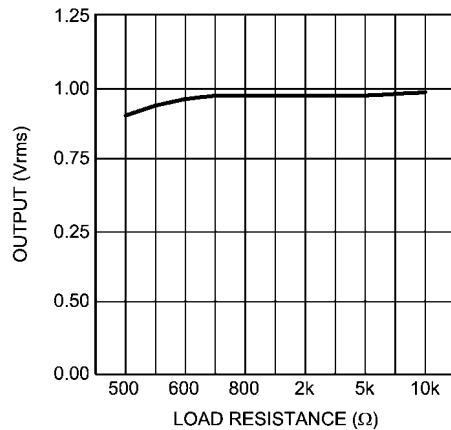

300038g9

Output Voltage vs Supply Voltage
 $R_L = 2k\Omega$, THD+N = 1%

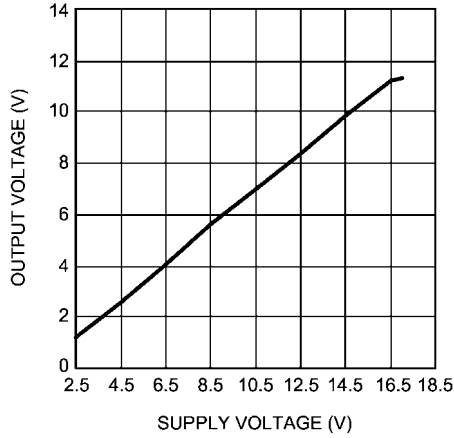

300038j9

Output Voltage vs Supply Voltage
 $R_L = 600\Omega$, THD+N = 1%

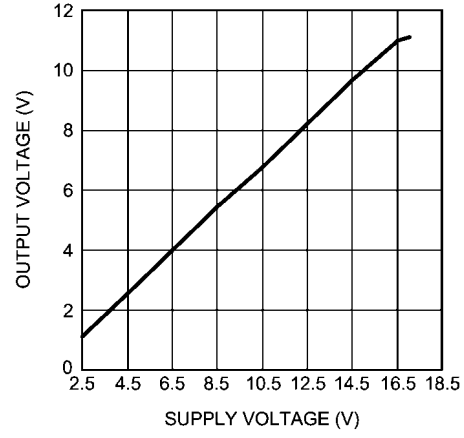

300038j8

Output Voltage vs Supply Voltage
 $R_L = 10k\Omega$, THD+N = 1%

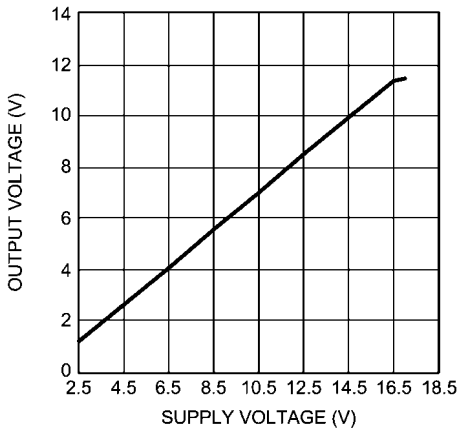

300038k0

Supply Current vs Supply Voltage
 $R_L = 2k\Omega$

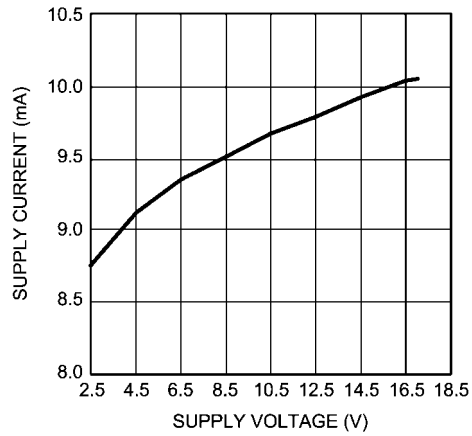

300038j6

Supply Current vs Supply Voltage
 $R_L = 600\Omega$

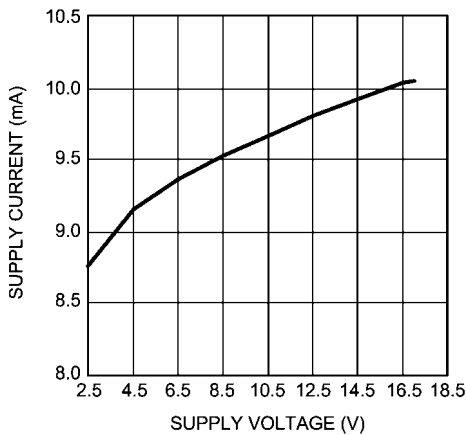

300038j5

Supply Current vs Supply Voltage
 $R_L = 10k\Omega$

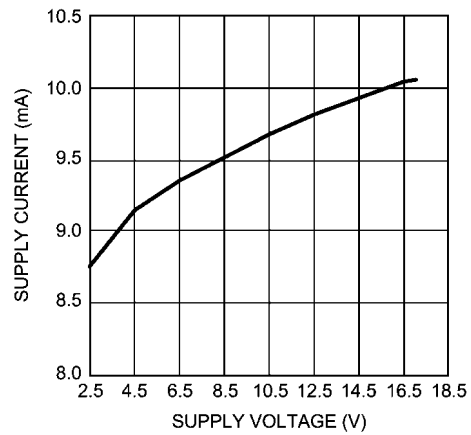

300038j7

Full Power Bandwidth vs Frequency

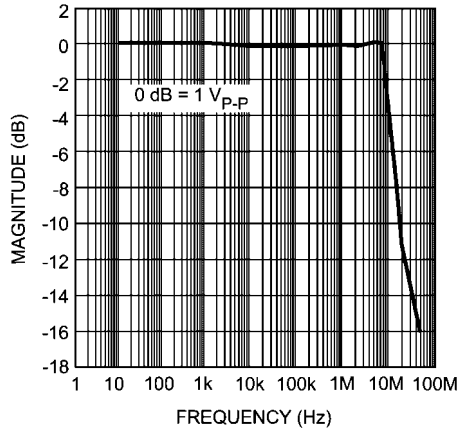

300038j0

Gain Phase vs Frequency

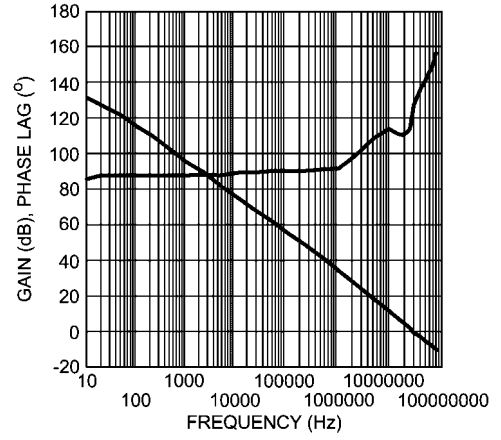

300038j1

Small-Signal Transient Response
 $A_V = 1, C_L = 10\text{pF}$

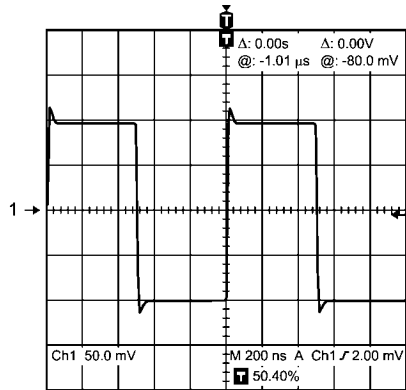

300038i7

Small-Signal Transient Response
 $A_V = 1, C_L = 100\text{pF}$

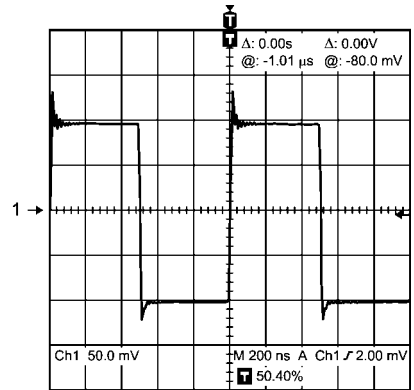

300038i8

Application Information

DISTORTION MEASUREMENTS

The vanishingly low residual distortion produced by LME49720 is below the capabilities of all commercially available equipment. This makes distortion measurements just slightly more difficult than simply connecting a distortion meter to the amplifier's inputs and outputs. The solution, however, is quite simple: an additional resistor. Adding this resistor extends the resolution of the distortion measurement equipment.

The LME49720's low residual distortion is an input referred internal error. As shown in Figure 1, adding the 10Ω resistor connected between the amplifier's inverting and non-inverting

inputs changes the amplifier's noise gain. The result is that the error signal (distortion) is amplified by a factor of 101. Although the amplifier's closed-loop gain is unaltered, the feedback available to correct distortion errors is reduced by 101, which means that measurement resolution increases by 101. To ensure minimum effects on distortion measurements, keep the value of R1 low as shown in Figure 1.

This technique is verified by duplicating the measurements with high closed loop gain and/or making the measurements at high frequencies. Doing so produces distortion components that are within the measurement equipment's capabilities. This datasheet's THD+N and IMD values were generated using the above described circuit connected to an Audio Precision System Two Cascade.

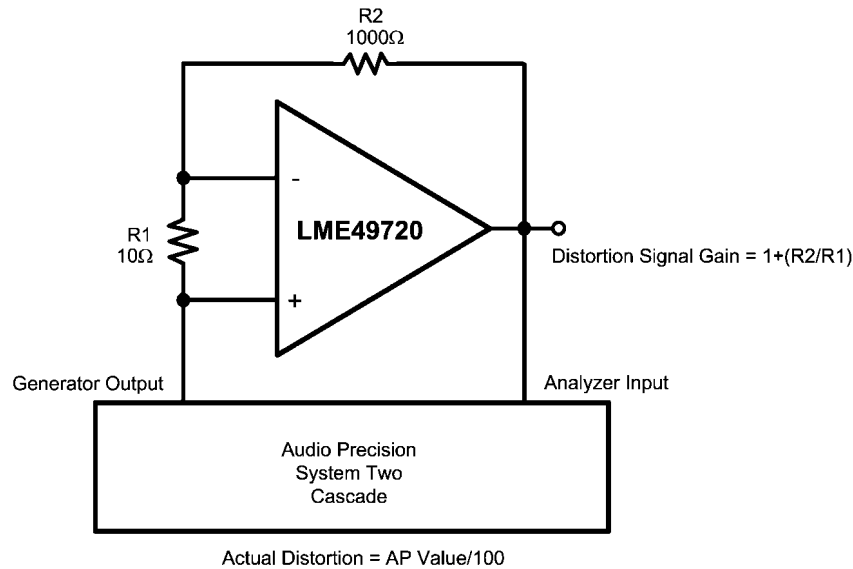

300038k4

FIGURE 1. THD+N and IMD Distortion Test Circuit

The LME49720 is a high speed op amp with excellent phase margin and stability. Capacitive loads up to 100pF will cause little change in the phase characteristics of the amplifiers and are therefore allowable.

Capacitive loads greater than 100pF must be isolated from the output. The most straightforward way to do this is to put

a resistor in series with the output. This resistor will also prevent excess power dissipation if the output is accidentally shorted.

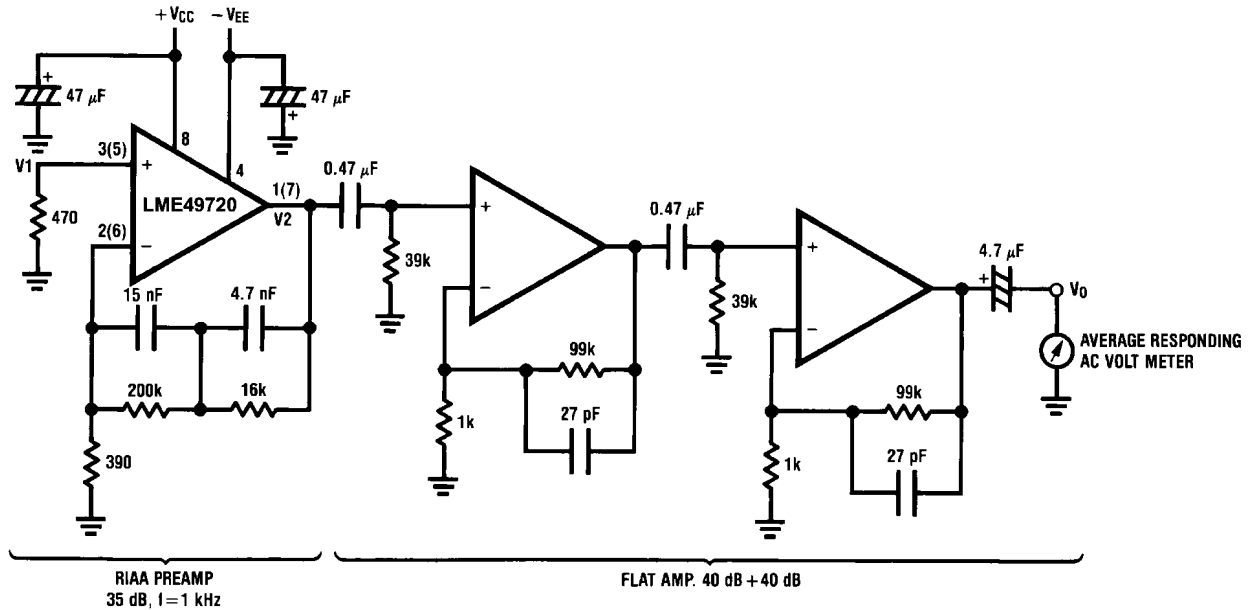

Complete shielding is required to prevent induced pick up from external sources. Always check with oscilloscope for power line noise.

30003827

Noise Measurement Circuit
Total Gain: 115 dB @ f = 1 kHz
Input Referred Noise Voltage: $e_n = V_0/560,000$ (V)

RIAA Preamp Voltage Gain, RIAA Deviation vs Frequency

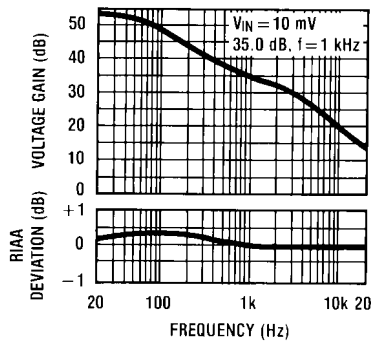

Flat Amp Voltage Gain vs Frequency

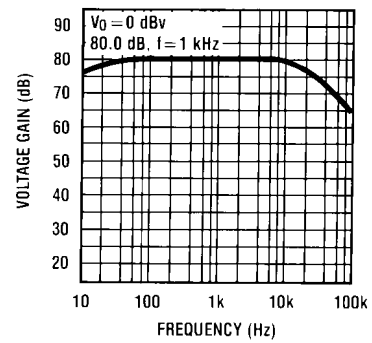

TYPICAL APPLICATIONS

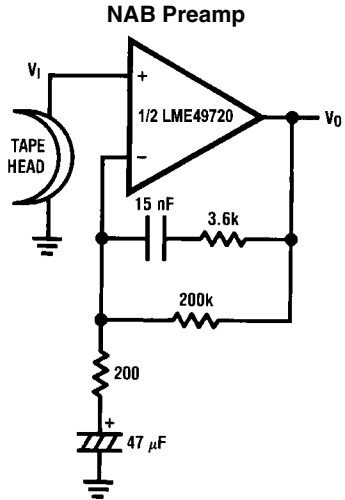

NAB Preamp Voltage Gain vs Frequency

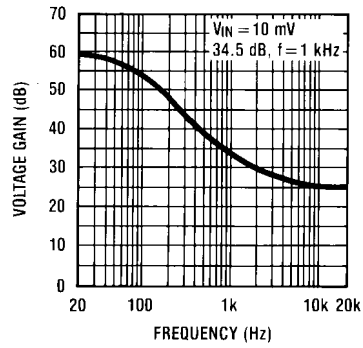

30003831

$A_V = 34.5$
 $F = 1 \text{ kHz}$
 $E_n = 0.38 \mu\text{V}$
 A Weighted

30003830

Balanced to Single Ended Converter

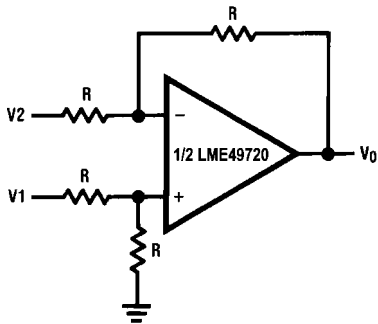

$V_O = V1 - V2$

30003832

Adder/Subtractor

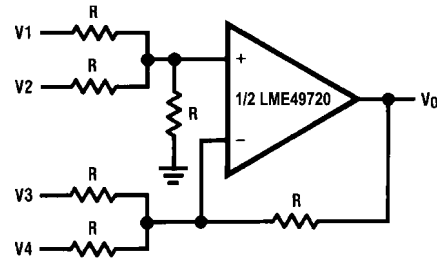

$V_O = V1 + V2 - V3 - V4$

30003833

Sine Wave Oscillator

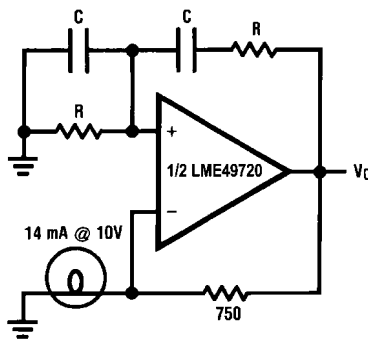

30003834

$f_o = \frac{1}{2\pi RC}$

Second Order High Pass Filter (Butterworth)

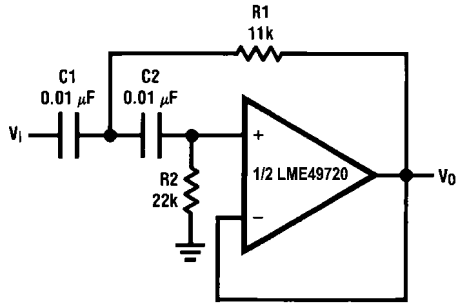

30003835

if $C1 = C2 = C$

$$R1 = \frac{\sqrt{2}}{2\omega_0 C}$$

$$R2 = 2 \cdot R1$$

Illustration is $f_0 = 1$ kHz

Second Order Low Pass Filter (Butterworth)

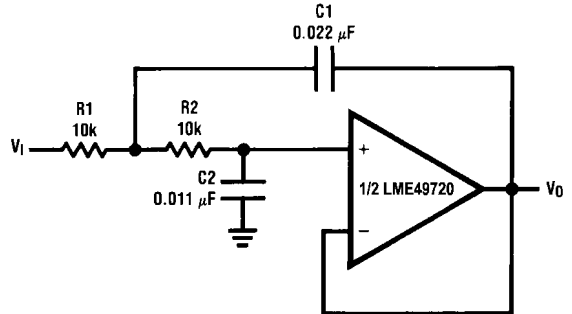

30003836

if $R1 = R2 = R$

$$C1 = \frac{\sqrt{2}}{\omega_0 R}$$

$$C2 = \frac{C1}{2}$$

Illustration is $f_0 = 1$ kHz

State Variable Filter

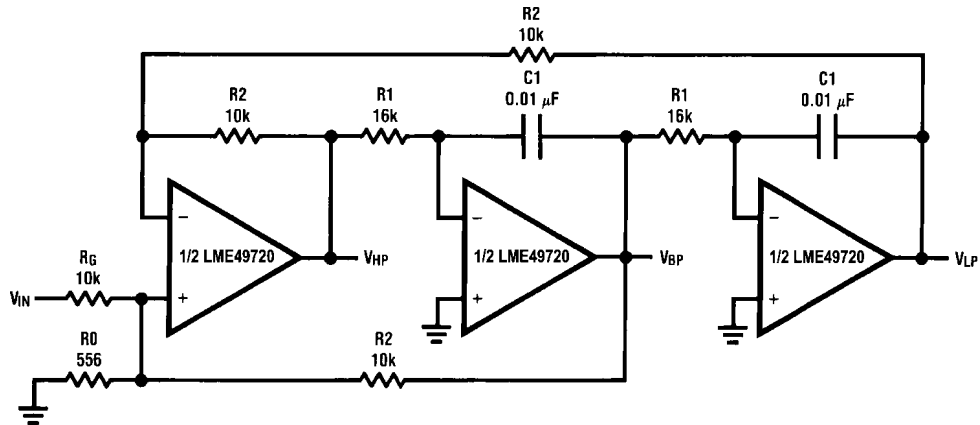

30003837

$$f_0 = \frac{1}{2\pi C1 R1}, Q = \frac{1}{2} \left(1 + \frac{R2}{R0} + \frac{R2}{RG} \right), A_{BP} = Q A_{LP} = Q A_{LH} = \frac{R2}{RG}$$

Illustration is $f_0 = 1$ kHz, $Q = 10$, $A_{BP} = 1$

AC/DC Converter

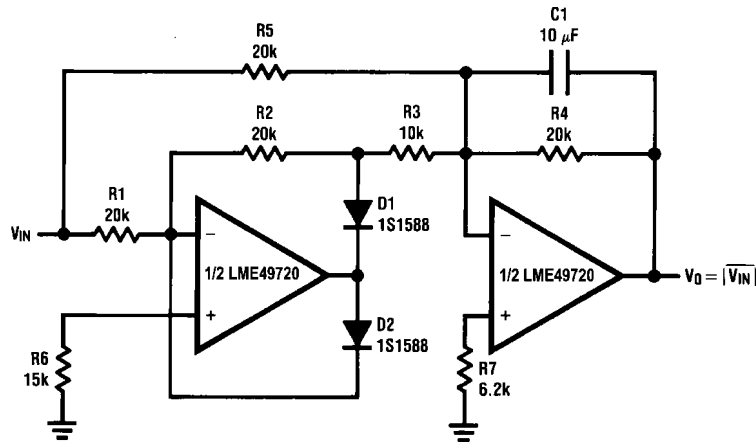

30003838

2 Channel Panning Circuit (Pan Pot)

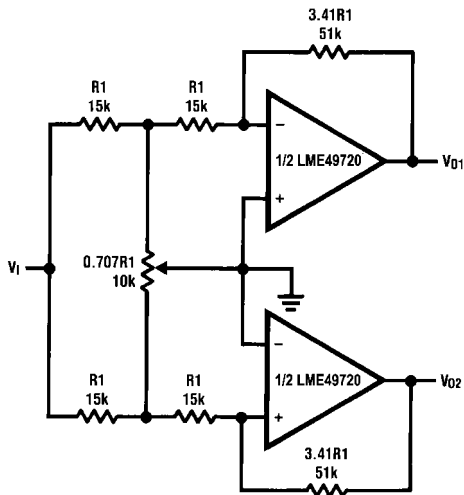

30003839

Line Driver

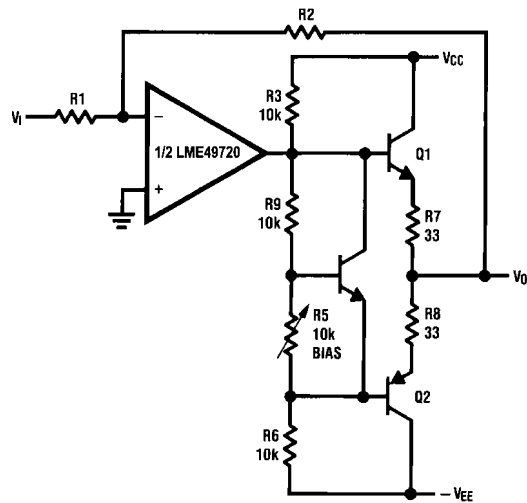

30003840

Tone Control

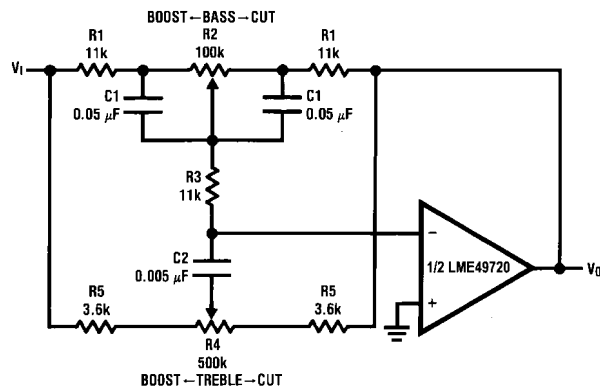

300038p0

$$f_L = \frac{1}{2\pi R2C1}, f_{LB} = \frac{1}{2\pi R1C1}$$

$$f_H = \frac{1}{2\pi R5C2}, f_{HB} = \frac{1}{2\pi(R1 + R5 + 2R3)C2}$$

Illustration is:
 $f_L = 32 \text{ Hz}$, $f_{LB} = 320 \text{ Hz}$
 $f_H = 11 \text{ kHz}$, $f_{HB} = 1.1 \text{ kHz}$

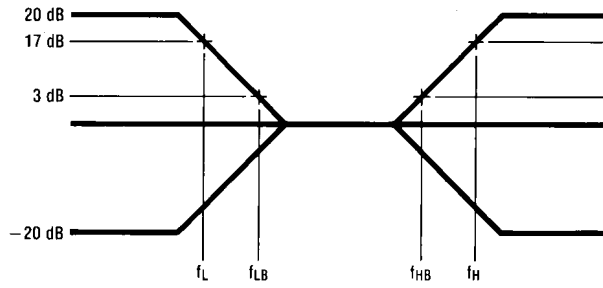

30003842

RIAA Preamp

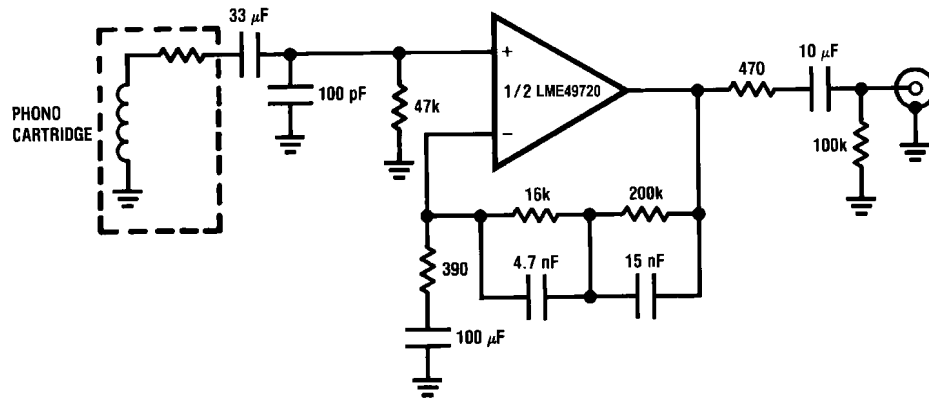

30003803

$A_v = 35 \text{ dB}$
 $E_n = 0.33 \mu\text{V}$
 $S/N = 90 \text{ dB}$
 $f = 1 \text{ kHz}$
 A Weighted
 A Weighted, $V_{IN} = 10 \text{ mV}$
 @ $f = 1 \text{ kHz}$

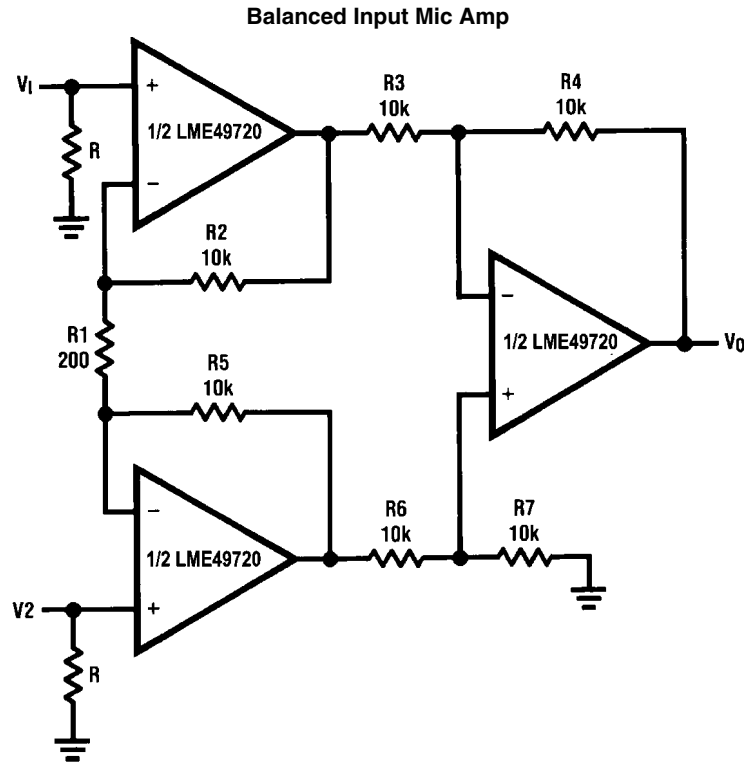

30003843

If $R_2 = R_5$, $R_3 = R_6$, $R_4 = R_7$

$$V_0 = \left(1 + \frac{2R_2}{R_1}\right) \frac{R_4}{R_3} (V_2 - V_1)$$

Illustration is:

$$V_0 = 101(V_2 - V_1)$$

10 Band Graphic Equalizer

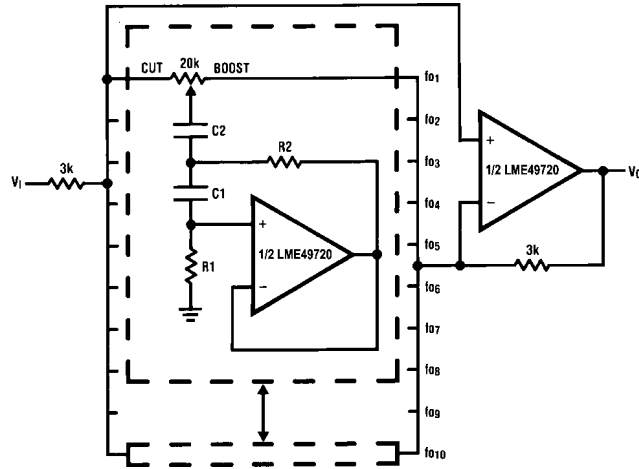

30003844

fo (Hz)	C ₁	C ₂	R ₁	R ₂
32	0.12μF	4.7μF	75kΩ	500Ω
64	0.056μF	3.3μF	68kΩ	510Ω
125	0.033μF	1.5μF	62kΩ	510Ω
250	0.015μF	0.82μF	68kΩ	470Ω
500	8200pF	0.39μF	62kΩ	470Ω
1k	3900pF	0.22μF	68kΩ	470Ω
2k	2000pF	0.1μF	68kΩ	470Ω
4k	1100pF	0.056μF	62kΩ	470Ω
8k	510pF	0.022μF	68kΩ	510Ω
16k	330pF	0.012μF	51kΩ	510Ω

Note 9: At volume of change = ±12 dB

Q = 1.7

Reference: "AUDIO/RADIO HANDBOOK", National Semiconductor, 1980, Page 2-61

Revision History

Rev	Date	Description
1.0	03/30/07	Initial release.
1.1	05/03/07	Put the "general note" under the EC table.
1.2	10/22/07	Replaced all the PSRR curves.

Physical Dimensions inches (millimeters) unless otherwise noted

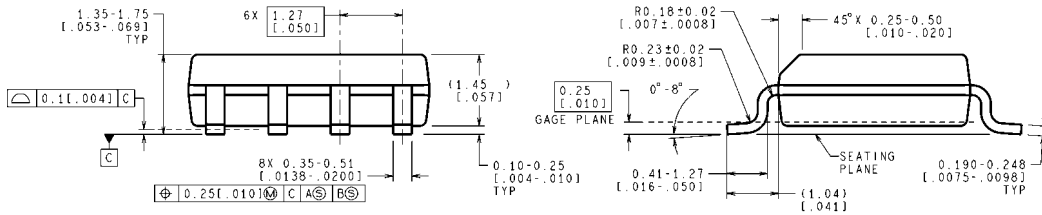
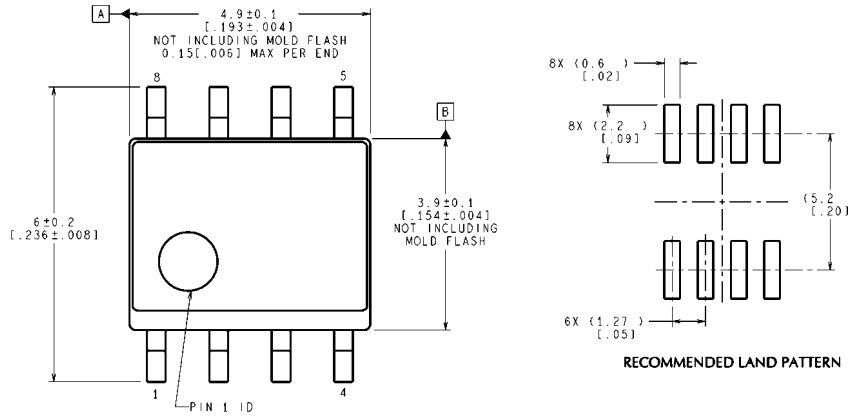

CONTROLLING DIMENSION IS MILLIMETER
VALUES IN [] ARE INCHES
DIMENSIONS IN () FOR REFERENCE ONLY

M08A (Rev L)

Narrow SOIC Package
Order Number LME49720MA
NS Package Number M08A

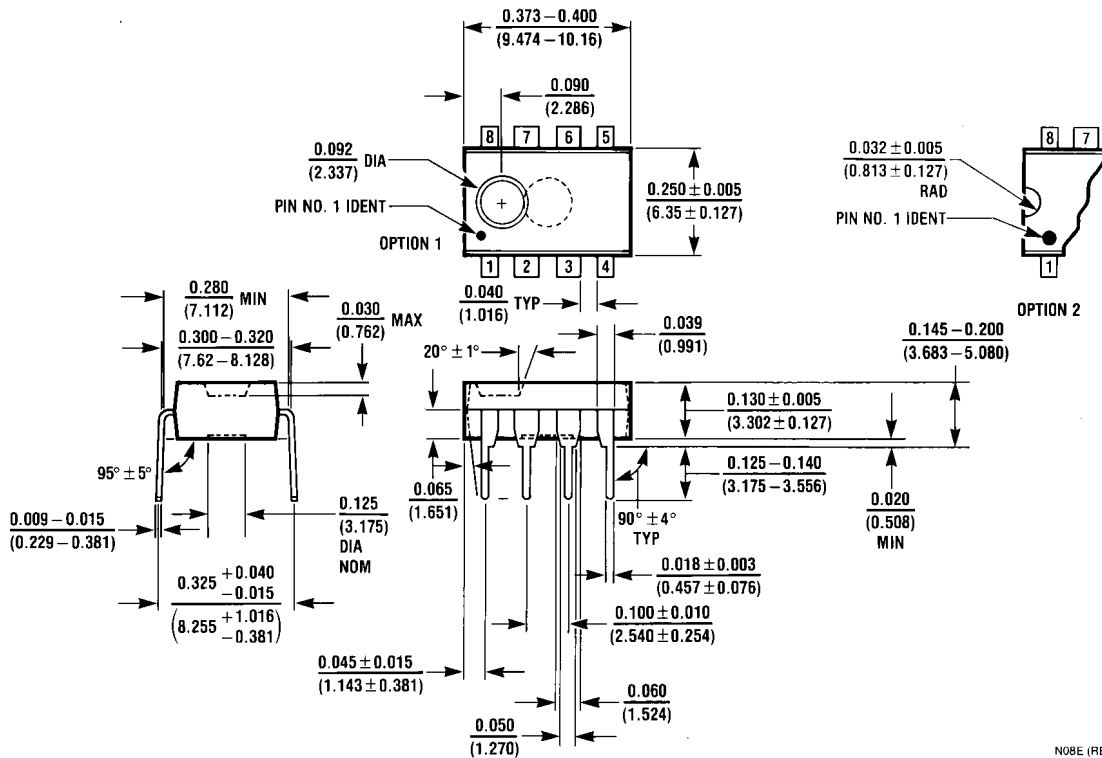

N08E (REV F)

Dual-In-Line Package
Order Number LME49720NA
NS Package Number N08E

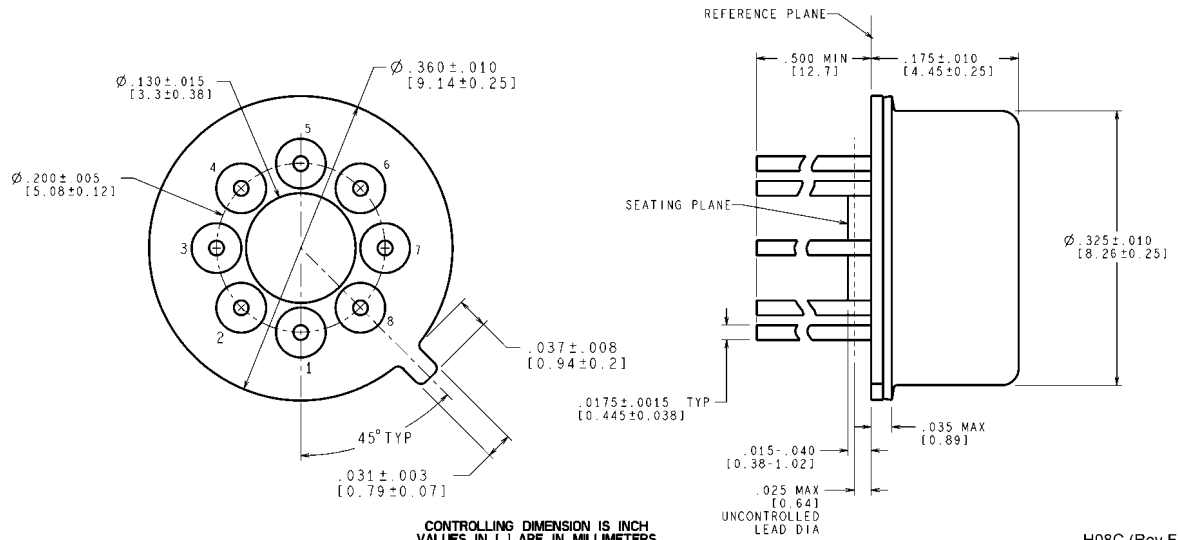

CONTROLLING DIMENSION IS INCH
VALUES IN [] ARE IN MILLIMETERS

TO-99 Metal Can Package
Order Number LME49720HA
NS Package Number H08C

H08C (Rev F)

Notes

THE CONTENTS OF THIS DOCUMENT ARE PROVIDED IN CONNECTION WITH NATIONAL SEMICONDUCTOR CORPORATION ("NATIONAL") PRODUCTS. NATIONAL MAKES NO REPRESENTATIONS OR WARRANTIES WITH RESPECT TO THE ACCURACY OR COMPLETENESS OF THE CONTENTS OF THIS PUBLICATION AND RESERVES THE RIGHT TO MAKE CHANGES TO SPECIFICATIONS AND PRODUCT DESCRIPTIONS AT ANY TIME WITHOUT NOTICE. NO LICENSE, WHETHER EXPRESS, IMPLIED, ARISING BY ESTOPPEL OR OTHERWISE, TO ANY INTELLECTUAL PROPERTY RIGHTS IS GRANTED BY THIS DOCUMENT.

TESTING AND OTHER QUALITY CONTROLS ARE USED TO THE EXTENT NATIONAL DEEMS NECESSARY TO SUPPORT NATIONAL'S PRODUCT WARRANTY. EXCEPT WHERE MANDATED BY GOVERNMENT REQUIREMENTS, TESTING OF ALL PARAMETERS OF EACH PRODUCT IS NOT NECESSARILY PERFORMED. NATIONAL ASSUMES NO LIABILITY FOR APPLICATIONS ASSISTANCE OR BUYER PRODUCT DESIGN. BUYERS ARE RESPONSIBLE FOR THEIR PRODUCTS AND APPLICATIONS USING NATIONAL COMPONENTS. PRIOR TO USING OR DISTRIBUTING ANY PRODUCTS THAT INCLUDE NATIONAL COMPONENTS, BUYERS SHOULD PROVIDE ADEQUATE DESIGN, TESTING AND OPERATING SAFEGUARDS.

EXCEPT AS PROVIDED IN NATIONAL'S TERMS AND CONDITIONS OF SALE FOR SUCH PRODUCTS, NATIONAL ASSUMES NO LIABILITY WHATSOEVER, AND NATIONAL DISCLAIMS ANY EXPRESS OR IMPLIED WARRANTY RELATING TO THE SALE AND/OR USE OF NATIONAL PRODUCTS INCLUDING LIABILITY OR WARRANTIES RELATING TO FITNESS FOR A PARTICULAR PURPOSE, MERCHANTABILITY, OR INFRINGEMENT OF ANY PATENT, COPYRIGHT OR OTHER INTELLECTUAL PROPERTY RIGHT.

LIFE SUPPORT POLICY

NATIONAL'S PRODUCTS ARE NOT AUTHORIZED FOR USE AS CRITICAL COMPONENTS IN LIFE SUPPORT DEVICES OR SYSTEMS WITHOUT THE EXPRESS PRIOR WRITTEN APPROVAL OF THE CHIEF EXECUTIVE OFFICER AND GENERAL COUNSEL OF NATIONAL SEMICONDUCTOR CORPORATION. As used herein:

Life support devices or systems are devices which (a) are intended for surgical implant into the body, or (b) support or sustain life and whose failure to perform when properly used in accordance with instructions for use provided in the labeling can be reasonably expected to result in a significant injury to the user. A critical component is any component in a life support device or system whose failure to perform can be reasonably expected to cause the failure of the life support device or system or to affect its safety or effectiveness.

National Semiconductor and the National Semiconductor logo are registered trademarks of National Semiconductor Corporation. All other brand or product names may be trademarks or registered trademarks of their respective holders.

Copyright© 2007 National Semiconductor Corporation

For the most current product information visit us at www.national.com



National Semiconductor Americas Customer Support Center
 Email: new.feedback@nsc.com
 Tel: 1-800-272-9959

National Semiconductor Europe Customer Support Center
 Fax: +49 (0) 180-530-85-86
 Email: europe.support@nsc.com
 Deutsch Tel: +49 (0) 69 9508 6208
 English Tel: +49 (0) 870 24 0 2171
 Français Tel: +33 (0) 1 41 91 8790

National Semiconductor Asia Pacific Customer Support Center
 Email: ap.support@nsc.com

National Semiconductor Japan Customer Support Center
 Fax: 81-3-5639-7507
 Email: jpn.feedback@nsc.com
 Tel: 81-3-5639-7560