

# Single, Dual, Quad General Purpose Micropower, RRIO Operational Amplifier

## ISL28113, ISL28213, ISL28413

The ISL28113, ISL28213, and ISL28413 are single, dual, and quad channel general purpose micropower, rail-to-rail input and output operational amplifiers with supply voltage range of 1.8V to 5.5V. Key features are a low supply current of 130µA maximum per channel at room temperature, a low bias current and a wide input voltage range, which enables the ISL28x13 devices to be excellent general purpose op-amps for a wide range of applications.

The ISL28113 is available in the SC70-5 and SOT23-5 packages, the ISL28213 is in the MSOP8, SOIC8, SOT23-8 packages, and the ISL28413 is in the TSSOP14, SOIC14 packages. All devices operate over the extended temperature range of -40°C to +125°C.

## Features

- Low Current Consumption . . . . . 130µA
- Wide Supply Range. . . . . 1.8V to 5.5V
- Gain Bandwidth Product . . . . . 2MHz
- Input Bias Current . . . . . 20pA, Max.
- Operating Temperature Range . . . . -40°C to +125°C
- Packages
  - ISL28113 (Single) . . . . . SC70-5, SOT23-5
  - ISL28213 (Dual) . . . . . MSOP8, SOIC8, SOT23-8
  - ISL28413 (Quad). . . . . SOIC14, TSSOP14

## Applications\* (see page 15)

- Power Supply Control/Regulation
- Process Control
- Signal Gain/Buffers
- Active Filters
- Current Shunt Sensing
- Trans-impedance Amps

## Related Literature\* (see page 15)

- See [AN1519](#) for "ISL28213/14SOICEVAL2Z Evaluation Board User's Guide"
- See [AN1520](#) for "ISL28113/14SOT23EVAL1Z Evaluation Board User's Guide"
- See [AN1542](#) for "ISL28213/14MSOPEVAL2Z Evaluation Board User's Guide"

## Typical Application

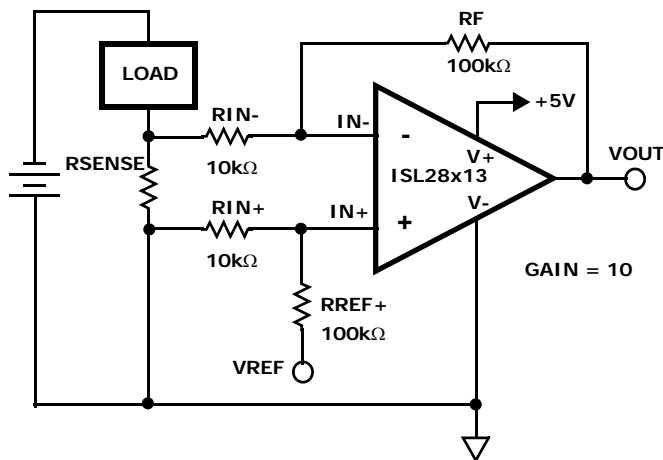

SINGLE-SUPPLY, LOW-SIDE CURRENT SENSE AMPLIFIER

## Ordering Information

PART NUMBER (Notes 2, 3)	PART MARKING	PACKAGE (Pb-Free)	PKG. DWG. #
ISL28113FEZ-T7 (Note 1)	BJA	5 Ld SC-70	P5.049
ISL28113FEZ-T7A (Note 1)	BJA	5 Ld SC-70	P5.049
ISL28113FHZ-T7 (Note 1)	BCYA	5 Ld SOT-23	MDP0038
ISL28113FHZ-T7A (Note 1)	BCYA	5 Ld SOT-23	MDP0038
ISL28213FUZ	8213Z	8 Ld MSOP	M8.118A
ISL28213FUZ-T7 (Note 1)	8213Z	8 Ld MSOP	M8.118A
ISL28213FBZ	28213 FBZ	8 Ld SOIC	M8.15E
ISL28213FBZ-T7 (Note 1)	28213 FBZ	8 Ld SOIC	M8.15E
ISL28213FBZ-T13 (Note 1)	28213 FBZ	8 Ld SOIC	M8.15E
<i>Coming Soon</i> ISL28213FHZ	TBD	8 Ld SOT-23	P8.064
<i>Coming Soon</i> ISL28213FHZ-T7 (Note 1)	TBD	8 Ld SOT-23	P8.064
ISL28413FVZ	28413 FVZ	14 Ld TSSOP	MDP0044
ISL28413FVZ-T7 (Note 1)	28413 FVZ	14 Ld TSSOP	MDP0044
ISL28413FVZ-T13 (Note 1)	28413 FVZ	14 Ld TSSOP	MDP0044
ISL28413FBZ	28413 FBZ	14 Ld SOIC	MDP0027
ISL28413FBZ-T7 (Note 1)	28413 FBZ	14 Ld SOIC	MDP0027
ISL28413FBZ-T13 (Note 1)	28413 FBZ	14 Ld SOIC	MDP0027
ISL28113SOT23EVAL1Z	Evaluation Board		
ISL28213MSOPEVAL2Z	Evaluation Board		
ISL28213SOICEVAL2Z	Evaluation Board		
ISL28413TSSOPEVAL1Z	Evaluation Board		

NOTES:

1. Please refer to [TB347](#) for details on reel specifications.
2. These Intersil Pb-free plastic packaged products employ special Pb-free material sets, molding compounds/die attach materials, and 100% matte tin plate plus anneal (e3 termination finish, which is RoHS compliant and compatible with both SnPb and Pb-free soldering operations). Intersil Pb-free products are MSL classified at Pb-free peak reflow temperatures that meet or exceed the Pb-free requirements of IPC/JEDEC J STD-020.
3. For Moisture Sensitivity Level (MSL), please see device information page for [ISL28113](#), [ISL28213](#), [ISL28413](#). For more information on MSL please see techbrief [TB363](#).

## Pin Configurations

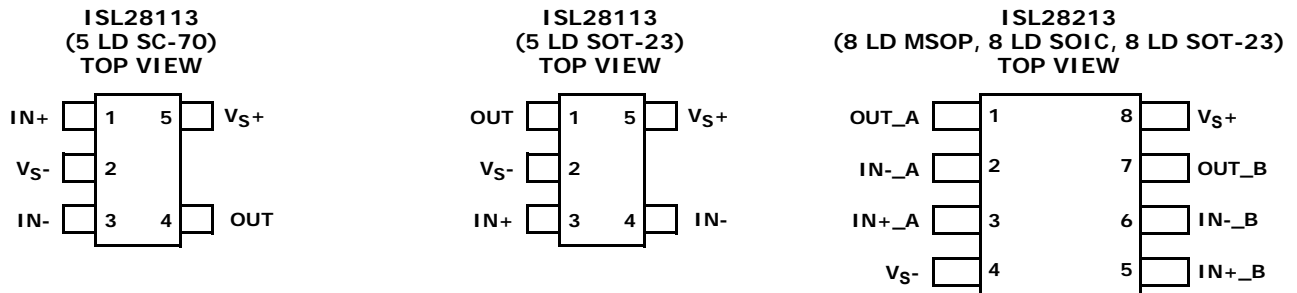

Pin Configurations (Continued)

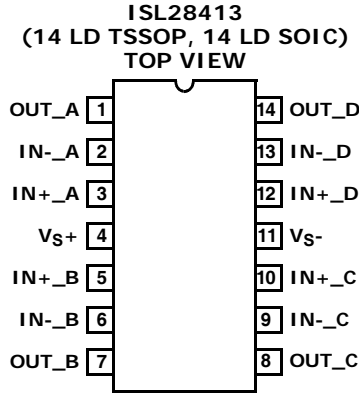

Pin Descriptions

PIN NAME	PIN NUMBER				DESCRIPTION	
	5 LD SC-70	5 LD SOT-23	8 LD MSOP, 8 LD SOIC, 8 LD SOT-23	14 LD TSSOP, 14 LD SOIC		
OUT OUT_A OUT_B OUT_C OUT_D	4	1	1 7	1 7 8 14	Output	 CIRCUIT 1
VS-	2	2	4	11	Negative supply voltage	 CAPACITIVELY TRIGGERED ESD CLAMP CIRCUIT 2
IN+ IN+_A IN+_B IN+_C IN+_D	1	3	3 5	3 5 10 12	Positive Input	 CIRCUIT 3
IN- IN-_A IN-_B IN-_C IN-_D	3	4	2 6	2 6 9 13	Negative Input	
VS+	5	5	8	4	Positive supply voltage	See Circuit 2

# ISL28113, ISL28213, ISL28413

## Absolute Maximum Ratings (T<sub>A</sub> = +25°C)

Supply Voltage	6.5V
Supply Turn-on Voltage Slew Rate	1V/μs
Differential Input Current	20mA
Differential Input Voltage	0.5V
Input Voltage	V <sub>-</sub> - 0.5V to V <sub>+</sub> + 0.5V
ESD Rating	
Human Body Model	4000V
Machine Model	
ISL28113, ISL28213	350V
ISL28413	400V
Charged Device Model	2000V

## Thermal Information

Thermal Resistance (Typical)	θ <sub>JA</sub> (°C/W)	θ <sub>JC</sub> (°C/W)
5 Ld SC-70 (Notes 4, 5)	250	N/A
5 Ld SOT-23 (Notes 4, 5)	225	N/A
8 Ld MSOP (Notes 4, 5)	180	100
8 Ld SOIC Package (Notes 4, 5)	126	90
8 Ld SOT-23	TBD	TBD
14 Ld TSSOP Package (Notes 4, 5)	120	40
14 Ld SOIC Package (Notes 4, 5)	90	50
Ambient Operating Temperature Range	-40°C to +125°C	
Storage Temperature Range	-65°C to +150°C	
Operating Junction Temperature	+125°C	
Pb-Free Reflow Profile	see link below	
	<a href="http://www.intersil.com/pbfree/Pb-FreeReflow.asp">http://www.intersil.com/pbfree/Pb-FreeReflow.asp</a>	

**CAUTION:** Do not operate at or near the maximum ratings listed for extended periods of time. Exposure to such conditions may adversely impact product reliability and result in failures not covered by warranty.

### NOTES:

- θ<sub>JA</sub> is measured with the component mounted on a high effective thermal conductivity test board in free air. See Tech Brief TB379 for details.
- For θ<sub>JC</sub>, the "case temp" location is the top of the package.

**Electrical Specifications** V<sub>S+</sub> = 5V, V<sub>S-</sub> = 0V, R<sub>L</sub> = Open, V<sub>CM</sub> = V<sub>S</sub>/2, T<sub>A</sub> = +25°C, unless otherwise specified.  
**Boldface limits apply over the operating temperature range, -40°C to +125°C, unless otherwise specified.**

PARAMETER	DESCRIPTION	CONDITIONS	MIN (Note 6)	TYP	MAX (Note 6)	UNIT
<b>DC SPECIFICATIONS</b>						
V <sub>OS</sub>	Input Offset Voltage		-5	0.5	5	mV
			<b>-6</b>		<b>6</b>	mV
TCV <sub>OS</sub>	Input Offset Voltage Temperature Coefficient	-40°C to +125°C		2	<b>10</b>	μV/°C
I <sub>OS</sub>	Input Offset Current			1	30	pA
I <sub>B</sub>	Input Bias Current	ISL28113	-20	3	20	pA
			<b>-100</b>		<b>100</b>	pA
		ISL28213, ISL28413	-20	3	20	pA
			<b>-50</b>		<b>50</b>	pA
Common Mode Input Voltage Range			<b>- 0.1V</b>		<b>+5.1V</b>	V
Z <sub>IN</sub>	Input Impedance			10 <sup>12</sup>		Ω
C <sub>IN</sub>	Input Capacitance			1		pF
CMRR	Common Mode Rejection Ratio	V <sub>CM</sub> = -0.1V to 5.1V		72		dB
				70		dB
PSRR	Power Supply Rejection Ratio	V <sub>S</sub> = 1.8V to 5.5V		71		dB
				70		dB
V <sub>OH</sub>	Output Voltage Swing, High	R <sub>L</sub> = 10kΩ	4.985	4.993		V
			<b>4.98</b>			V
V <sub>OL</sub>	Output Voltage Swing, Low	R <sub>L</sub> = 10kΩ		13	15	mV
					<b>20</b>	mV
V <sub>+</sub>	Supply Voltage		1.8		5.5	V

# ISL28113, ISL28213, ISL28413

**Electrical Specifications**  $V_{S+} = 5V$ ,  $V_{S-} = 0V$ ,  $R_L = \text{Open}$ ,  $V_{CM} = V_{S+}/2$ ,  $T_A = +25^\circ\text{C}$ , unless otherwise specified.  
**Boldface limits apply over the operating temperature range,  $-40^\circ\text{C}$  to  $+125^\circ\text{C}$ , unless otherwise specified.**

PARAMETER	DESCRIPTION	CONDITIONS	MIN (Note 6)	TYP	MAX (Note 6)	UNIT
$I_S$	Supply Current per Amplifier	$R_L = \text{OPEN}$		90	130	$\mu\text{A}$
					<b>170</b>	$\mu\text{A}$
$I_{SC+}$	Output Source Short Circuit Current	$R_L = 10\Omega$ to $V_-$		-22		mA
$I_{SC-}$	Output Sink Short Circuit Current	$R_L = 10\Omega$ to $V_+$		16		mA
<b>AC SPECIFICATIONS</b>						
GBWP	Gain Bandwidth Product	$V_S = \pm 2.5V$ $A_V = 100$ , $R_F = 100k\Omega$ , $R_G = 1k\Omega$ , $R_L = 10k\Omega$ to $V_{CM}$		2		MHz
$e_N V_{P-P}$	Peak-to-Peak Input Noise Voltage	$V_S = \pm 2.5V$ $f = 0.1\text{Hz}$ to $10\text{Hz}$		14		$\mu\text{V}_{P-P}$
$e_N$	Input Noise Voltage Density	$V_S = \pm 2.5V$ $f = 1\text{kHz}$		55		$\text{nV}/\sqrt{\text{Hz}}$
$i_N$	Input Noise Current Density	$V_S = \pm 2.5V$ $f = 1\text{kHz}$		5		$\text{fA}/\sqrt{\text{Hz}}$
$C_{in}$	Differential Input Capacitance	$V_S = \pm 2.5V$ $f = 1\text{MHz}$		1.0		pF
	Common Mode Input Capacitance			1.3		pF
<b>TRANSIENT RESPONSE</b>						
SR	Slew Rate 20% to 80% $V_{OUT}$	$V_{OUT} = 0.5V$ to $4.5V$		1		$\text{V}/\mu\text{s}$
$t_r$ , $t_f$ , Small Signal	Rise Time, $t_r$ 10% to 90%	$V_S = \pm 2.5V$ $A_V = +1$ , $V_{OUT} = 0.05V_{P-P}$ , $R_F = 0\Omega$ , $R_L = 10k\Omega$ , $C_L = 15\text{pF}$		100		ns
	Fall Time, $t_f$ 10% to 90%			115		ns
$t_s$	Settling Time to 0.1%, $4V_{P-P}$ Step	$V_S = \pm 2.5V$ $A_V = +1$ , $R_F = 0\Omega$ , $R_L = 10k\Omega$ , $C_L = 1.2\text{pF}$		7.5		$\mu\text{s}$

NOTE:

6. Parameters with MIN and/or MAX limits are 100% tested at  $+25^\circ\text{C}$ , unless otherwise specified. Temperature limits established by characterization and are not production tested.

## Typical Performance Curves

$V_S = \pm 2.5V$ ,  $V_{CM} = 0V$ ,  $R_L = \text{Open}$ , unless otherwise specified.

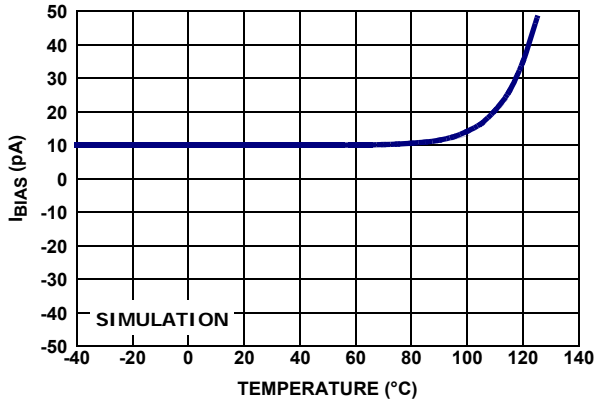

FIGURE 1. INPUT BIAS CURRENT vs TEMPERATURE

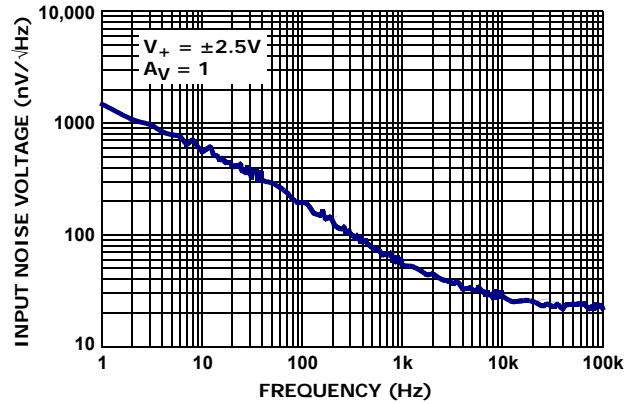

FIGURE 2. INPUT NOISE VOLTAGE SPECTRAL DENSITY

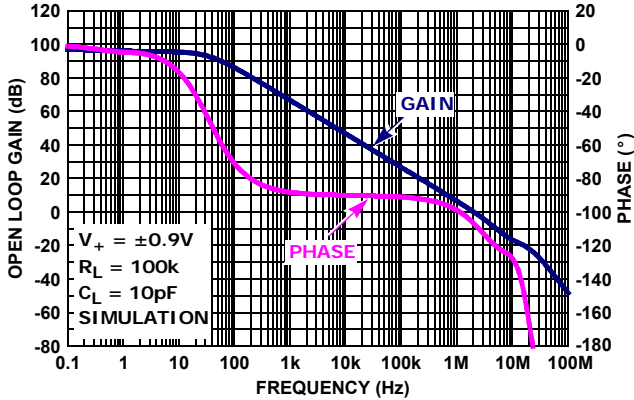

FIGURE 3. OPEN-LOOP GAIN, PHASE vs FREQUENCY,  $R_L = 100k\Omega$ ,  $C_L = 10pF$ ,  $V_S = \pm 0.9V$

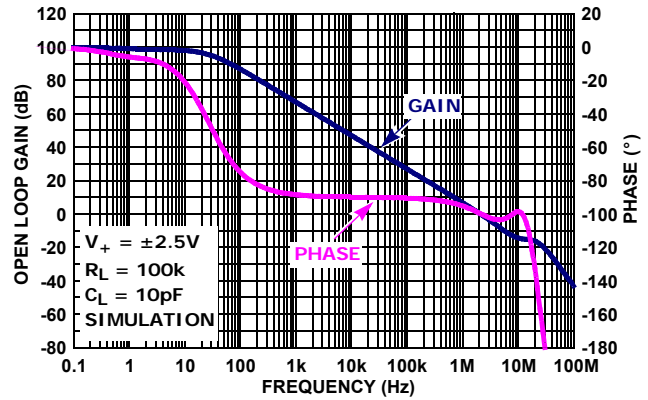

FIGURE 4. OPEN-LOOP GAIN, PHASE vs FREQUENCY,  $R_L = 100k\Omega$ ,  $C_L = 100F$ ,  $V_S = \pm 2.5V$

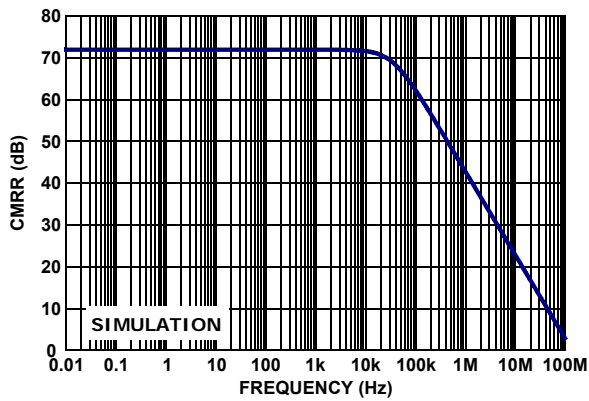

FIGURE 5. CMRR vs FREQUENCY,  $V_S = \pm 2.5$

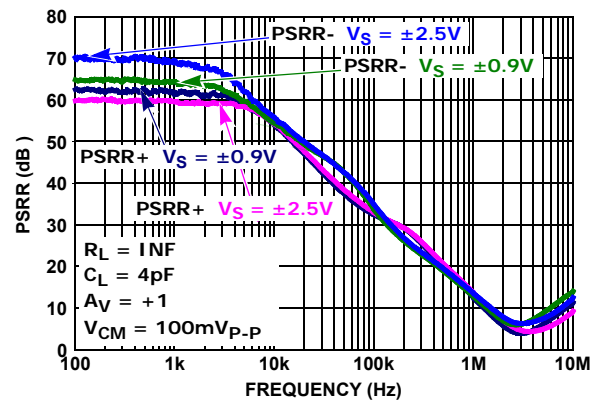

FIGURE 6. PSRR vs FREQUENCY,  $V_S = \pm 0.9V, \pm 2.5V$

Typical Performance Curves

$V_S = \pm 2.5V$ ,  $V_{CM} = 0V$ ,  $R_L = \text{Open}$ , unless otherwise specified. (Continued)

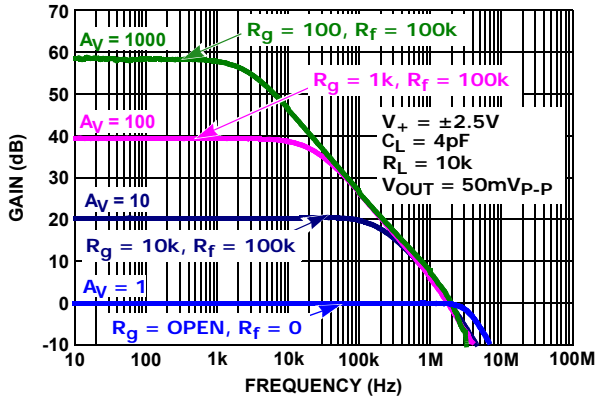

FIGURE 7. FREQUENCY RESPONSE vs CLOSED LOOP GAIN

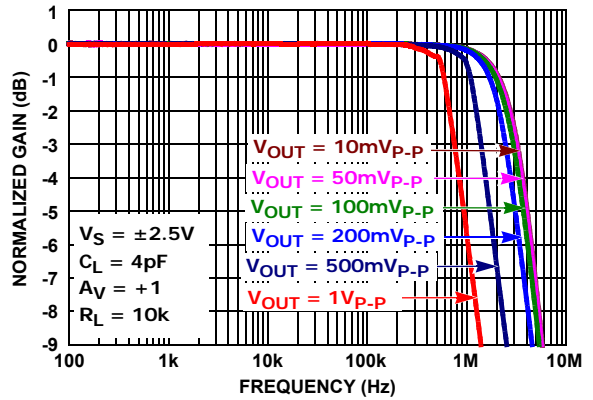

FIGURE 8. FREQUENCY RESPONSE vs  $V_{OUT}$

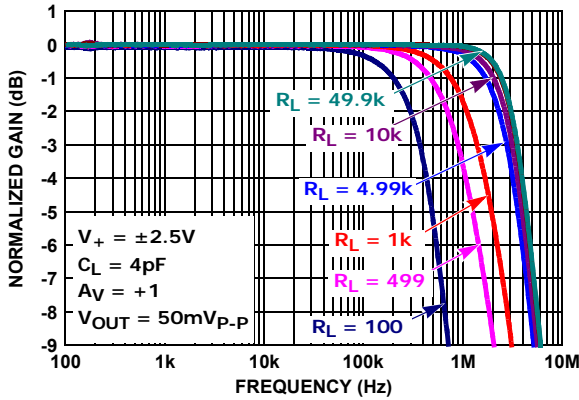

FIGURE 9. GAIN vs FREQUENCY vs  $R_L$

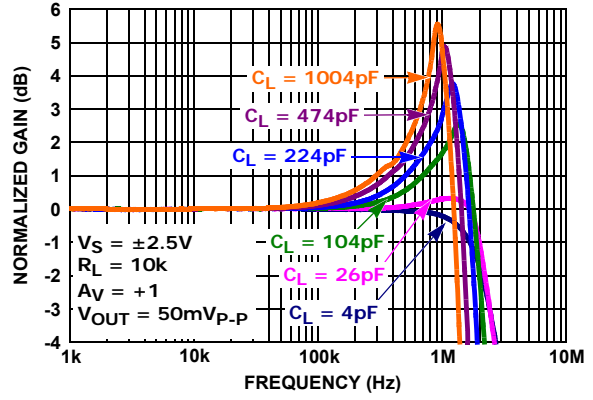

FIGURE 10. GAIN vs FREQUENCY vs  $C_L$

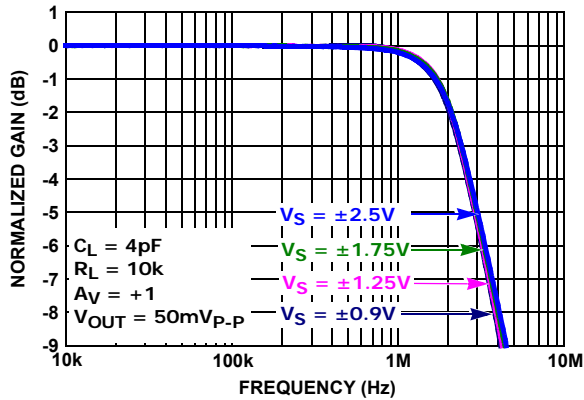

FIGURE 11. GAIN vs FREQUENCY vs SUPPLY VOLTAGE

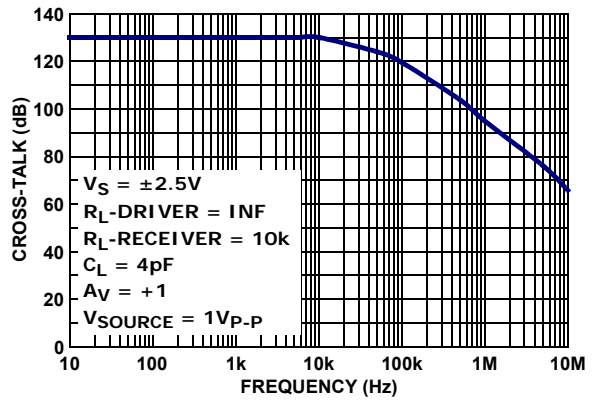

FIGURE 12. CROSSTALK,  $V_S = \pm 2.5V$

Typical Performance Curves

$V_S = \pm 2.5V$ ,  $V_{CM} = 0V$ ,  $R_L = \text{Open}$ , unless otherwise specified. (Continued)

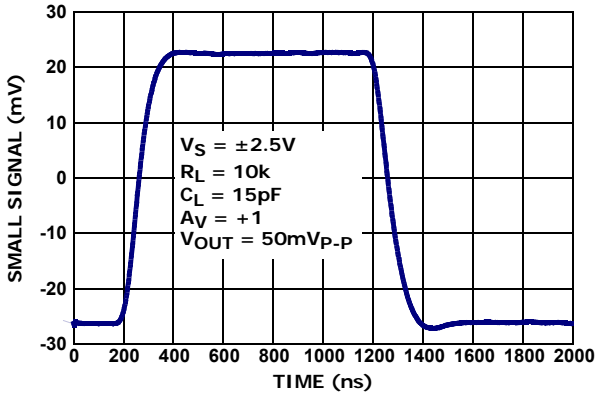

FIGURE 13. SMALL SIGNAL TRANSIENT RESPONSE,  $V_S = \pm 2.5V$

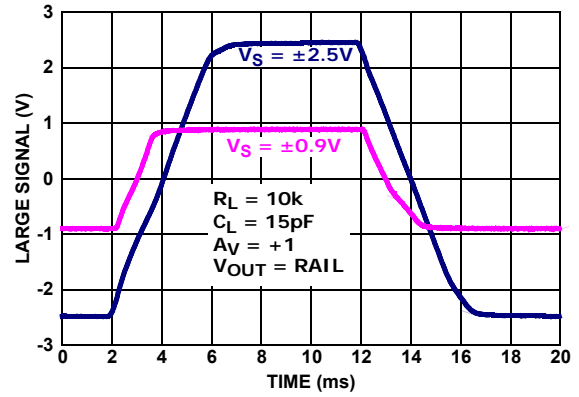

FIGURE 14. LARGE SIGNAL TRANSIENT RESPONSE vs  $R_L$   $V_S = \pm 0.9V, \pm 2.5V$

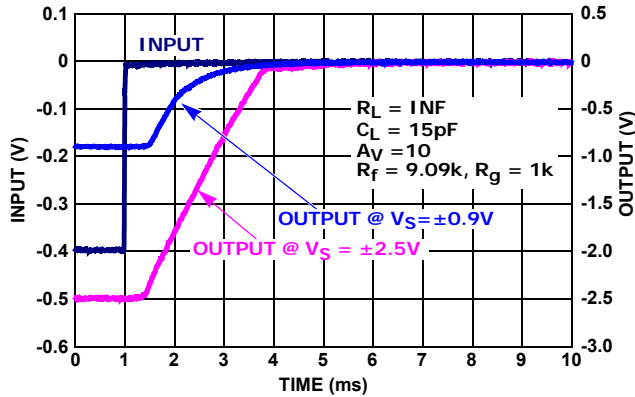

FIGURE 15. NEGATIVE OUTPUT OVERLOAD RESPONSE TIME,  $V_S = \pm 0.9V, \pm 2.5V$

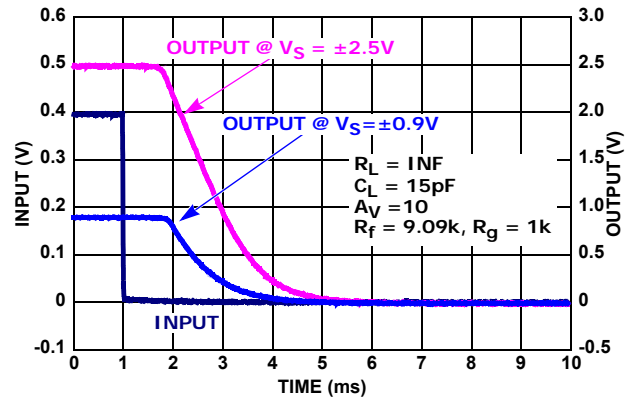

FIGURE 16. POSITIVE OUTPUT OVERLOAD RESPONSE TIME,  $V_S = \pm 0.9V, \pm 2.5V$

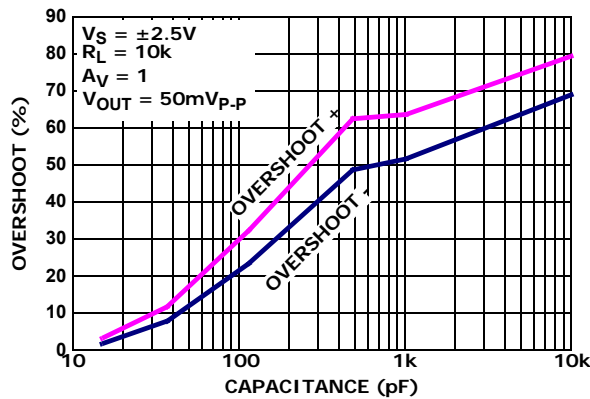

FIGURE 17. % OVERSHOOT vs LOAD CAPACITANCE,  $V_S = \pm 2.5V$



## Applications Information

### Functional Description

The ISL28113, ISL28213 and ISL28413 are single, dual and quad, CMOS rail-to-rail input, output (RRIO) micropower operational amplifiers. They are designed to operate from single supply (1.8V to 5.5V) or dual supply ( $\pm 0.9V$  to  $\pm 2.75V$ ). The parts have an input common mode range that extends 100mV above and below the power supply voltage rails. The output stage can swing to within 15mV of the supply rails with a 10k $\Omega$  load.

### Input ESD Diode Protection

All input terminals have internal ESD protection diodes to both positive and negative supply rails, limiting the input voltage to within one diode beyond the supply rails. They also contain back-to-back diodes across the input terminals (see "Pin Descriptions - Circuit 1" on page 3). For applications where the input differential voltage is expected to exceed 0.5V, an external series resistor must be used to ensure the input currents never exceed 20mA (see Figure 18).

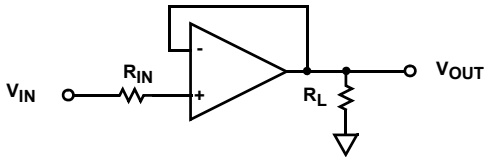

FIGURE 18. INPUT CURRENT LIMITING

Although the amplifier is fully protected, high input slew rates that exceed the amplifier slew rate ( $\pm 1V/\mu s$ ) may cause output distortion.

### Output Phase Reversal

Output phase reversal is a change of polarity in the amplifier transfer function when the input voltage exceeds the supply voltage. The ISL28113, ISL28213 and ISL28413 are immune to output phase reversal, even when the input voltage is 1V beyond the supplies.

### Unused Channels

If the application requires less than all amplifiers one channel, the user must configure the unused channel(s) to prevent it from oscillating. The unused channel(s) will oscillate if the input and output pins are floating. This will result in higher than expected supply currents and possible noise injection into the channel being used. The proper way to prevent this oscillation is to short the output to the inverting input and ground the positive input (as shown in Figure 19).

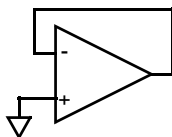

FIGURE 19. PREVENTING OSCILLATIONS IN UNUSED CHANNELS

### Power Dissipation

It is possible to exceed the +125°C maximum junction temperatures under certain load, power supply conditions and ambient temperature conditions. It is therefore important to calculate the maximum junction temperature ( $T_{JMAX}$ ) for all applications to determine if power supply voltages, load conditions, or package type need to be modified to remain in the safe operating area. These parameters are related using Equation 1:

$$T_{JMAX} = T_{MAX} + \theta_{JA} \times PD_{MAXTOTAL} \quad (EQ. 1)$$

where:

- $PD_{MAXTOTAL}$  is the sum of the maximum power dissipation of each amplifier in the package ( $PD_{MAX}$ )
- $PD_{MAX}$  for each amplifier can be calculated using Equation 2:

$$PD_{MAX} = V_S \times I_{qMAX} + (V_S - V_{OUTMAX}) \times \frac{V_{OUTMAX}}{R_L} \quad (EQ. 2)$$

where:

- $T_{MAX}$  = Maximum ambient temperature
- $\theta_{JA}$  = Thermal resistance of the package
- $PD_{MAX}$  = Maximum power dissipation of 1 amplifier
- $V_S$  = Total supply voltage
- $I_{qMAX}$  = Maximum quiescent supply current of 1 amplifier
- $V_{OUTMAX}$  = Maximum output voltage swing of the application
- $R_L$  = Load resistance

### ISL28113, ISL28213 and ISL28413 SPICE Model

Figure 20 shows the SPICE model schematic and Figure 21 shows the net list for the SPICE model. The model is a simplified version of the actual device and simulates important AC and DC parameters. AC parameters incorporated into the model are: 1/f and flatband noise, Slew Rate, CMRR, Gain and Phase. The DC parameters are IOS, total supply current and output voltage swing. The model uses typical parameters given in the "Electrical Specifications" Table beginning on page 4. The AVOL is adjusted for 85dB with the dominate pole at 100Hz. The CMRR is set 72dB,  $f = 35kHz$ ). The input stage models the actual device to present an accurate AC representation. The model is configured for ambient temperature of +25°C.

Figures 22 through 31 show the characterization vs simulation results for the Noise Voltage, Closed Loop Gain vs Frequency, Large Signal 5V Step Response, CMRR and Open Loop Gain Phase.

## LICENSE STATEMENT

The information in this SPICE model is protected under the United States copyright laws. Intersil Corporation hereby grants users of this macro-model hereto referred to as "Licensee", a nonexclusive, nontransferable licence to use this model as long as the Licensee abides by the terms of this agreement. Before using this macro-model, the Licensee should read this license. If the Licensee does not accept these terms, permission to use the model is not granted.

The Licensee may not sell, loan, rent, or license the macro-model, in whole, in part, or in modified form, to anyone outside the Licensee's company. The Licensee may modify the macro-model to suit his/her specific applications, and the Licensee may make copies of this macro-model for use within their company only.

This macro-model is provided "AS IS, WHERE IS, AND WITH NO WARRANTY OF ANY KIND EITHER EXPRESSED OR IMPLIED, INCLUDING BUY NOT LIMITED TO ANY IMPLIED WARRANTIES OF MERCHANTABILITY AND FITNESS FOR A PARTICULAR PURPOSE."

In no event will Intersil be liable for special, collateral, incidental, or consequential damages in connection with or arising out of the use of this macro-model. Intersil reserves the right to make changes to the product and the macro-model without prior notice.

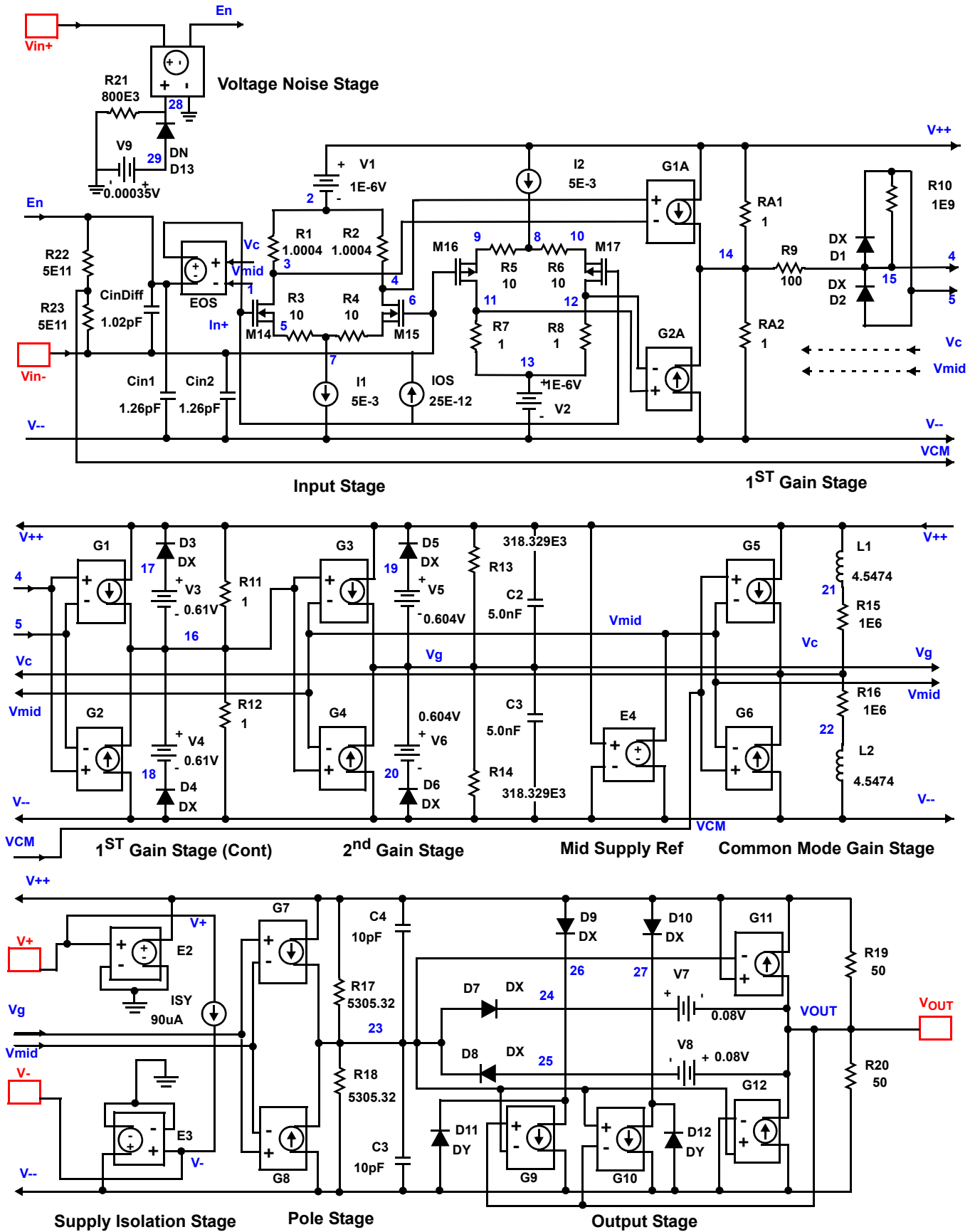

FIGURE 20. SPICE SCHEMATIC

# ISL28113, ISL28213, ISL28413

```

* source ISL28113_SPICEmodel
* Revision D, LaFontaine February 22, 2010 Improved noise
performance
* Model for Noise, supply currents, CMRR 72dB f=35kHz ,AVOL 85dB
f=100Hz
* SR = 1.0V/us, GBWP 2MHz, 2nd pole 3MHz Output voltage clamp
and short ckt I limit
*Copyright 2009 by Intersil Corporation
*Refer to data sheet "LICENSE STATEMENT" Use of
*this model indicates your acceptance with the
*terms and provisions in the License Statement.
* Connections:
      +input
      |
      | -input
      | +Vsupply
      | -Vsupply
      |
      | output
      |
.subckt ISL28113subckt Vin+ Vin- V+ V- VOUT
* source ISL28113_DS rev1
*
*Voltage Noise
E_En VIN+ EN 28 0 1
D_D13 29 28 DN
V_V9 29 0 0.45
R_R21 28 0 30
*
*Input Stage
M_M14 3 1 5 5 NCHANNELMOSFET
M_M15 4 VIN- 6 6 NCHANNELMOSFET
M_M16 11 VIN- 9 9 PMOSISIL
M_M17 12 1 10 10 PMOSISIL
L_L1 7 V-- DC 5e-3
L_L2 V++ 8 DC 5e-3
L_IOS VIN- 1 DC 25e-12
G_G1A V++ 14 4 3 1404
G_G2A V-- 14 11 12 1404
V_V1 V++ 2 1e-6
V_V2 13 V-- 1e-6
R_R1 3 2 1.0004
R_R2 4 2 1.0004
R_R3 5 7 10
R_R4 7 6 10
R_R5 9 8 10
R_R6 8 10 10
R_R7 13 11 1
R_R8 13 12 1
R_RA1 14 V++ 1
R_RA2 V-- 14 1
C_CinDif VIN- EN 1.02E-12
C_Cin1 V-- EN 1.26e-12
C_Cin2 V-- VIN- 1.26e-12
*
*1st Gain Stage
G_G1 V++ 16 15 VMID 334.753e-3
G_G2 V-- 16 15 VMID 334.753e-3
V_V3 17 16 .61
V_V4 16 18 .61
D_D1 15 VMID DX
D_D2 VMID 15 DX
D_D3 17 V++ DX
D_D4 V-- 18 DX
R_R9 15 14 100
R_R10 15 VMID 1e9
R_R11 16 V++ 1
R_R12 V-- 16 1
*
*2nd Gain Stage
G_G3 V++ VG 16 VMID 24.893e-3
G_G4 V-- VG 16 VMID 24.893e-3
V_V5 19 VG .604
V_V6 VG 20 .604
D_D5 19 V++ DX
D_D6 V-- 20 DX
R_R13 VG V++ 318.329e3
R_R14 V-- VG 318.329e3
C_C2 VG V++ 5E-09
C_C3 V-- VG 5E-09
*
*Mid supply Ref
E_E4 VMID V-- V++ V-- 0.5
E_E2 V++ 0 V+ 0 1
E_E3 V-- 0 V- 0 1
L_ISY V+ V- DC 90e-6
*
*Common Mode Gain Stage with Zero
G_G5 V++ VC VCM VMID 0.25118
G_G6 V-- VC VCM VMID 0.25118
E_EOS 1 EN VC VMID 1
R_R15 VC 21 0.001
R_R16 22 VC 0.001
R_R22 EN VCM 5e11
R_R23 VCM VIN- 5e11
L_L1 21 V++ 4.547418E-09
L_L2 22 V-- 4.547418E-09
*
*Pole Stage
G_G7 V++ 23 VG VMID 0.18849
G_G8 V-- 23 VG VMID 0.18849
R_R17 23 V++ 5.30532
R_R18 V-- 23 5.30532
C_C4 23 V++ 1e-8
C_C5 V-- 23 1e-8
*
*Output Stage with Correction Current Sources
G_G9 26 V-- VOUT 23 0.02
G_G10 27 V-- 23 VOUT 0.02
G_G11 VOUT V++ V++ 23 0.02
G_G12 V-- VOUT 23 V-- 0.02
V_V7 24 VOUT .08
V_V8 VOUT 25 .08
D_D7 23 24 DX
D_D8 25 23 DX
D_D9 V++ 26 DX
D_D10 V++ 27 DX
D_D11 V-- 26 DY
D_D12 V-- 27 DY
R_R19 VOUT V++ 50
R_R20 V-- VOUT 50
.model pmosil pmos (kp=16e-3 vto=-0.6)
.model NCHANNELMOSFET nmos (kp=3e-3 vto=0.6)
.model DN D(KF=6.69e-9 AF=1)
.MODEL DX D(IS=1E-12 Rs=0.1)
.MODEL DY D(IS=1E-15 BV=50 Rs=1)
.ends ISL28113subckt

```

FIGURE 21. SPICE NET LIST

## Characterization vs Simulation Results

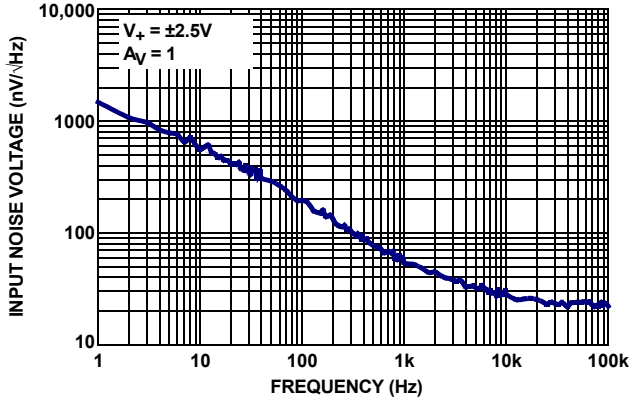

FIGURE 22. CHARACTERIZED INPUT NOISE VOLTAGE

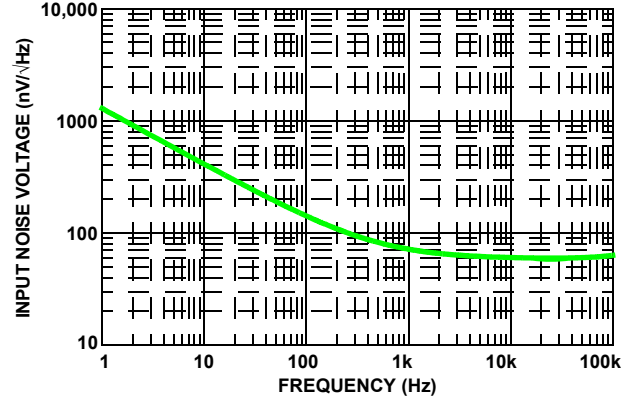

FIGURE 23. SIMULATED INPUT NOISE VOLTAGE

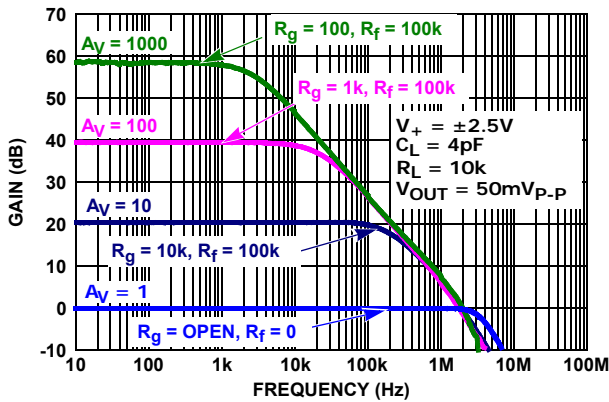

FIGURE 24. CHARACTERIZED CLOSED LOOP GAIN vs FREQUENCY

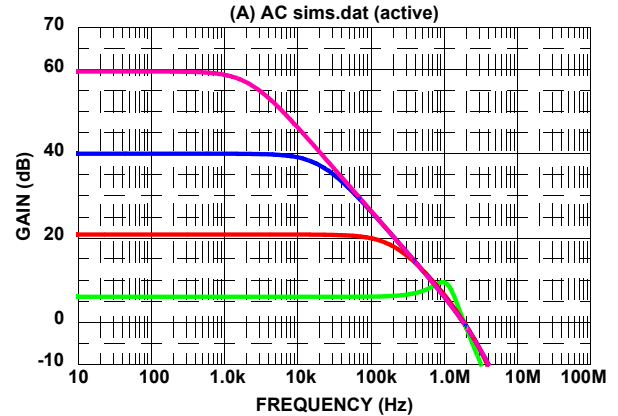

FIGURE 25. SIMULATED CLOSED LOOP GAIN vs FREQUENCY

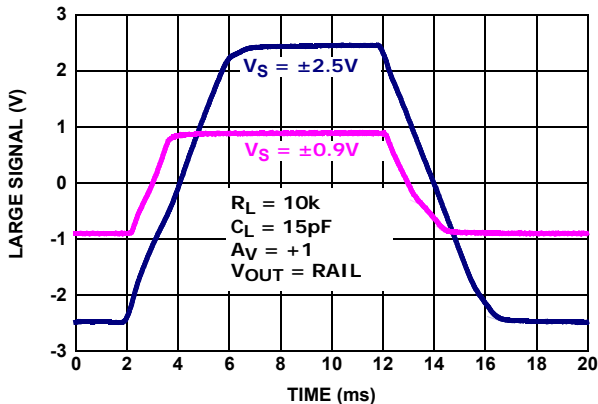

FIGURE 26. CHARACTERIZED LARGE SIGNAL TRANSIENT RESPONSE vs  $R_L$ ,  $V_S = \pm 0.9V, \pm 2.5V$

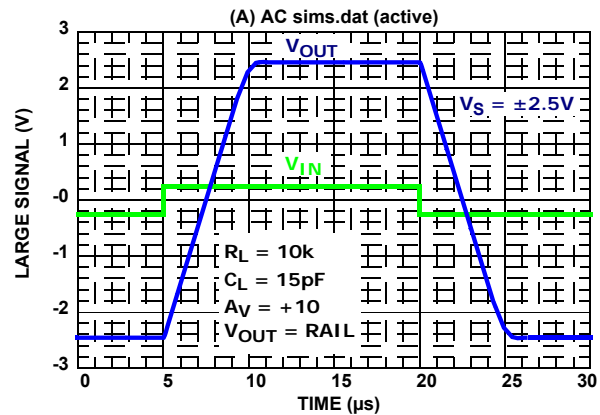

FIGURE 27. SIMULATED LARGE SIGNAL TRANSIENT RESPONSE vs  $R_L$ ,  $V_S = \pm 0.9V, \pm 2.5V$

Characterization vs Simulation Results (Continued)

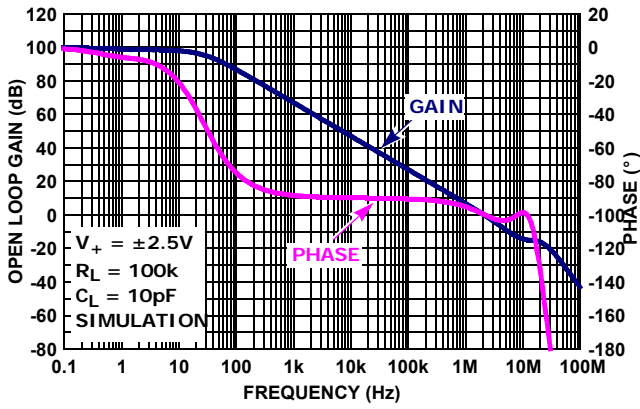

FIGURE 28. SIMULATED (DESIGN) OPEN-LOOP GAIN, PHASE vs FREQUENCY

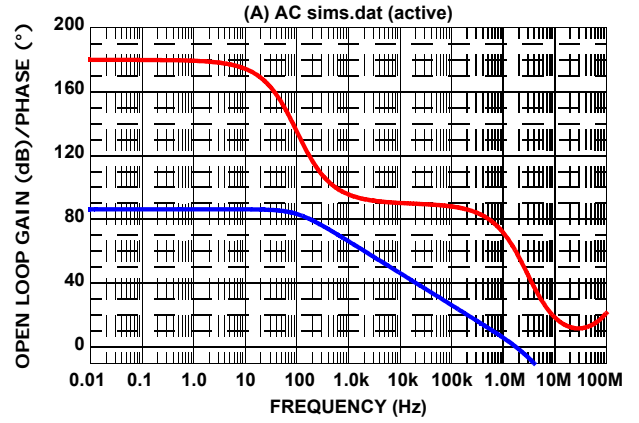

FIGURE 29. SIMULATED (SPICE) OPEN-LOOP GAIN, PHASE vs FREQUENCY

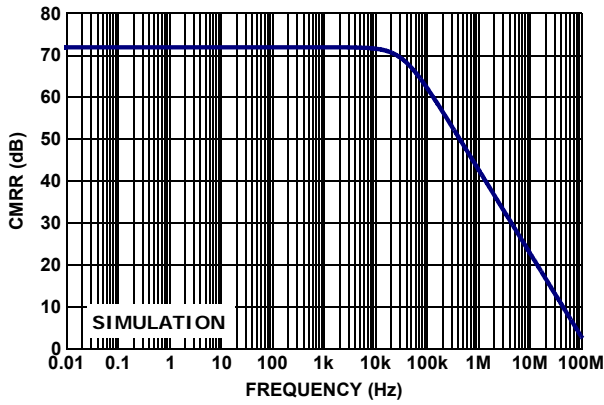

FIGURE 30. SIMULATED (DESIGN) CMRR

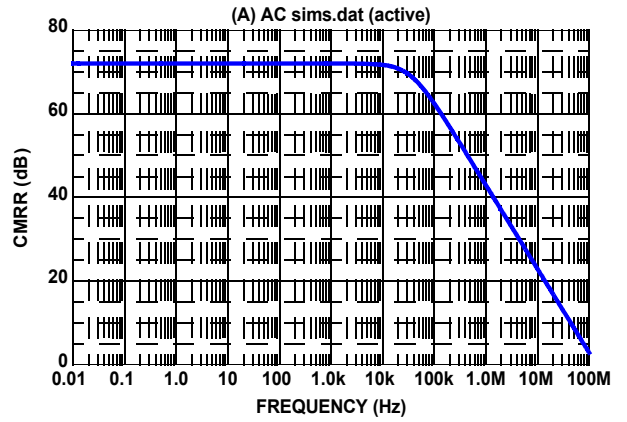

FIGURE 31. SIMULATED (SPICE) CMRR

## Revision History

The revision history provided is for informational purposes only and is believed to be accurate, but not warranted. Please go to Web to make sure you have the latest Rev.

DATE	REVISION	CHANGE
3/23/10	FN6728.4	Page 1, 2nd paragraph - Added "...SOT23-8 packages..." and changed "SO8" to "SOIC8".  Also global, changed S08 to SOIC8  On page 2, Ordering Information table: Part Number ISL28213FEZ changed to ISL28213FHZ and Part Marking changed to "TBD"
3/22/10		-Added Related Literature on page 1, updated ordering information by adding Eval boards. -Added to ordering information part number ISL28213FHZ 8 Ld SOT-23 Package as coming soon. -Replaced Figure 23 Simulated Input Noise Voltage with following changes: Y-axis from "10 to 100" to "10,000 to 10" Removed (A) AC sims.dat (active) from top of graph Curve changed to improve noise performance Made changes to Spice Net List as follows: -Changed Revision from "C" to "D" and added improved noise performance to Revision line. -Changed in Voltage Noise "V_V9 29 0 .00035" to "V_V9 29 0 0.45" "R_R21 28 0 800E3 TC=0,0" to "R_R21 28 0 30" -Removed TC=0 in Input Stage from R_R1 through C_Cin2 -Removed TC=0 in 1st Gain Stage from R_R9 through R_R12 -Removed TC=0 in 2nd Gain Stage from R_R13 through C_C3 -Changed in Common Mode Gain Stage with Zero "G_G5 V++ VC VCM VMID 2.5118E-10" to "G_G5 V++ VC VCM VMID 0.25118" "G_G6 V-- VC VCM VMID 2.5118E-10" to "G_G6 V-- VC VCM VMID 0.25118" Removed TC=0 from R_R16 through R_R23 -Changed in Pole Stage "G_G7 V++ 23 VG VMID 188.49e-6" to "G_G7 V++ 23 VG VMID 0.18849" "G_G8 V-- 23 VG VMID 188.49e-6" to "G_G8 V-- 23 VG VMID 0.18849" Removed TC=0 from R_R17 through C_C5 Removed TC=0 in Output Stage with Correction Current Sources from R_R19 and R_R20 Made changes to Spice Schematic Figure 20 as follows: -Input Stage - Modified connection to the EOS (voltage control voltage source) -Added to Thermal Information 8 LD SOT-23 as TBD -Added to pin configuration for the ISL28213 8 Ld SOT-23
12/16/09	FN6728.3	Removed "Coming Soon" from MSOP package options in the "Ordering Information" on page 2. Updated the Theta JA for the MSOP package option from 170°C/W to 180°C/W on page 4.
11/17/09	FN6728.2	Removed "Coming Soon" from SC70 and SOT-23 package options in the "Ordering Information" on page 2.
11/12/09	FN6728.1	Changed theta Ja to 250 from 300. Added license statement (page 10) and reference in spice model (page 12).
10/26/09	FN6728.0	Initial Release

## Products

Intersil Corporation is a leader in the design and manufacture of high-performance analog semiconductors. The Company's products address some of the industry's fastest growing markets, such as, flat panel displays, cell phones, handheld products, and notebooks. Intersil's product families address power management and analog signal processing functions. Go to [www.intersil.com/products](http://www.intersil.com/products) for a complete list of Intersil product families.

\*For a complete listing of Applications, Related Documentation and Related Parts, please see the respective device information page on intersil.com: [ISL28113](http://www.intersil.com/products), [ISL28213](http://www.intersil.com/products), [ISL28413](http://www.intersil.com/products)

To report errors or suggestions for this datasheet, please go to [www.intersil.com/askourstaff](http://www.intersil.com/askourstaff)

FITs are available from our website at <http://rel.intersil.com/reports/search.php>

Small Outline Transistor Plastic Packages (SC70-5)

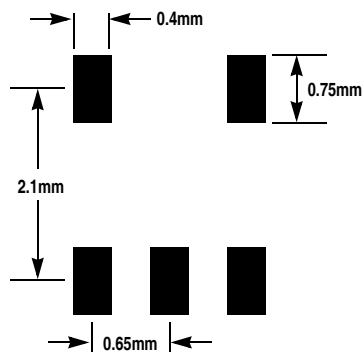
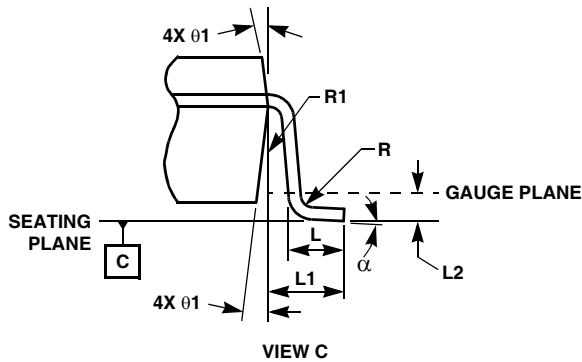
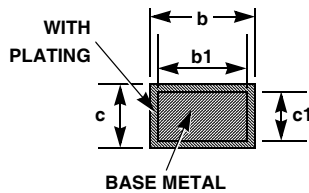
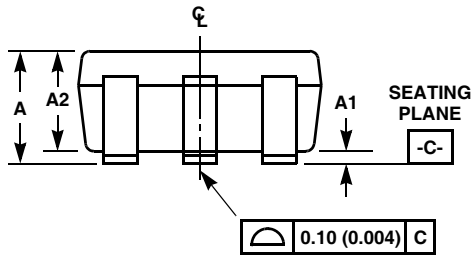
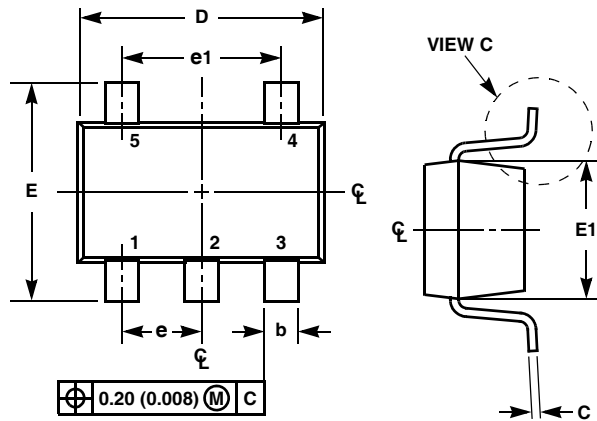

TYPICAL RECOMMENDED LAND PATTERN

P5.049

5 LEAD SMALL OUTLINE TRANSISTOR PLASTIC PACKAGE

SYMBOL	INCHES		MILLIMETERS		NOTES
	MIN	MAX	MIN	MAX	
A	0.031	0.043	0.80	1.10	-
A1	0.000	0.004	0.00	0.10	-
A2	0.031	0.039	0.80	1.00	-
b	0.006	0.012	0.15	0.30	-
b1	0.006	0.010	0.15	0.25	-
c	0.003	0.009	0.08	0.22	6
c1	0.003	0.009	0.08	0.20	6
D	0.073	0.085	1.85	2.15	3
E	0.071	0.094	1.80	2.40	-
E1	0.045	0.053	1.15	1.35	3
e	0.0256 Ref		0.65 Ref		-
e1	0.0512 Ref		1.30 Ref		-
L	0.010	0.018	0.26	0.46	4
L1	0.017 Ref.		0.420 Ref.		-
L2	0.006 BSC		0.15 BSC		-
$\alpha$	0°	8°	0°	8°	-
N	5		5		5
R	0.004	-	0.10	-	-
R1	0.004	0.010	0.15	0.25	-

Rev. 3 7/07

NOTES:

1. Dimensioning and tolerances per ASME Y14.5M-1994.
2. Package conforms to EIAJ SC70 and JEDEC MO-203AA.
3. Dimensions D and E1 are exclusive of mold flash, protrusions, or gate burrs.
4. Footlength L measured at reference to gauge plane.
5. "N" is the number of terminal positions.
6. These Dimensions apply to the flat section of the lead between 0.08mm and 0.15mm from the lead tip.
7. Controlling dimension: MILLIMETER. Converted inch dimensions are for reference only.



SOT-23 Package Family

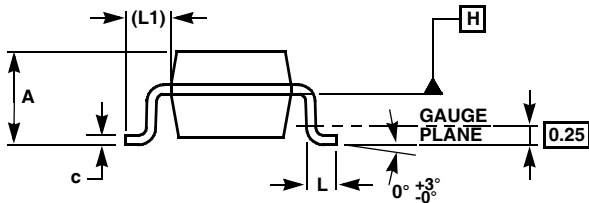
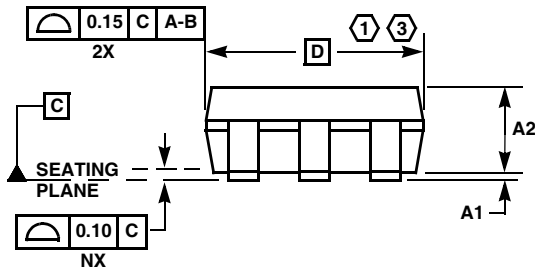
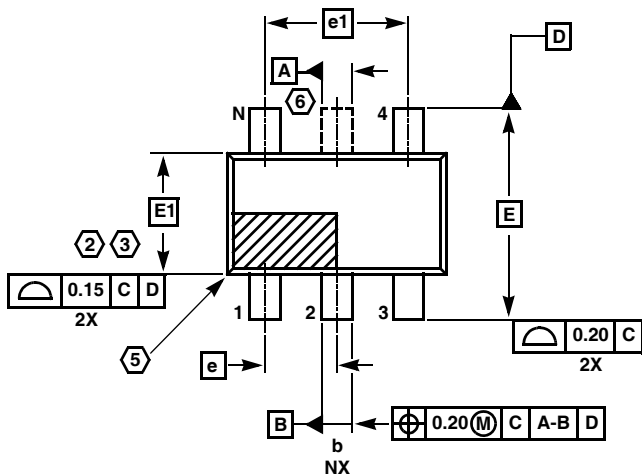

MDP0038  
SOT-23 PACKAGE FAMILY

SYMBOL	MILLIMETERS		TOLERANCE
	SOT23-5	SOT23-6	
A	1.45	1.45	MAX
A1	0.10	0.10	$\pm 0.05$
A2	1.14	1.14	$\pm 0.15$
b	0.40	0.40	$\pm 0.05$
c	0.14	0.14	$\pm 0.06$
D	2.90	2.90	Basic
E	2.80	2.80	Basic
E1	1.60	1.60	Basic
e	0.95	0.95	Basic
e1	1.90	1.90	Basic
L	0.45	0.45	$\pm 0.10$
L1	0.60	0.60	Reference
N	5	6	Reference

Rev. F 2/07

NOTES:

1. Plastic or metal protrusions of 0.25mm maximum per side are not included.
2. Plastic interlead protrusions of 0.25mm maximum per side are not included.
3. This dimension is measured at Datum Plane "H".
4. Dimensioning and tolerancing per ASME Y14.5M-1994.
5. Index area - Pin #1 I.D. will be located within the indicated zone (SOT23-6 only).
6. SOT23-5 version has no center lead (shown as a dashed line).

# Package Outline Drawing

## M8.118A

8 LEAD MINI SMALL OUTLINE PLASTIC PACKAGE (MSOP)

Rev 0, 9/09

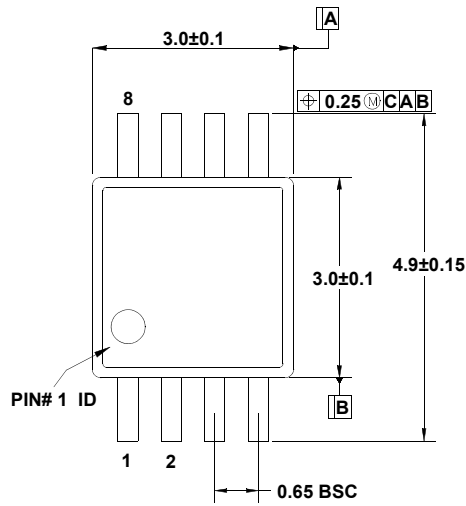

**TOP VIEW**

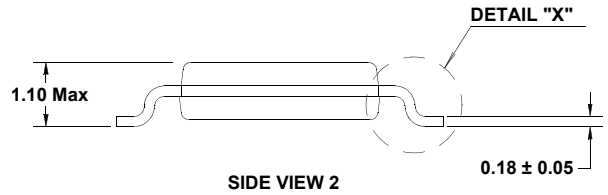

**SIDE VIEW 2**

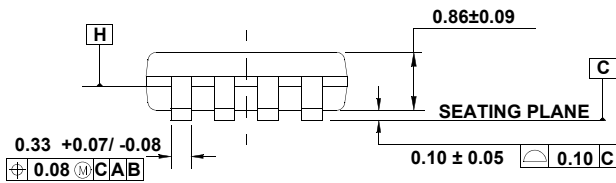

**SIDE VIEW 1**

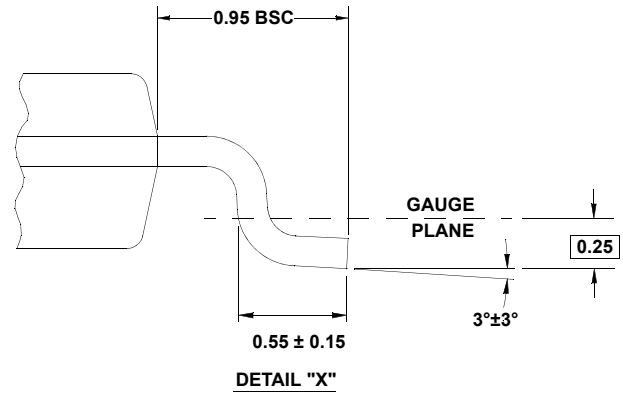

**DETAIL "X"**

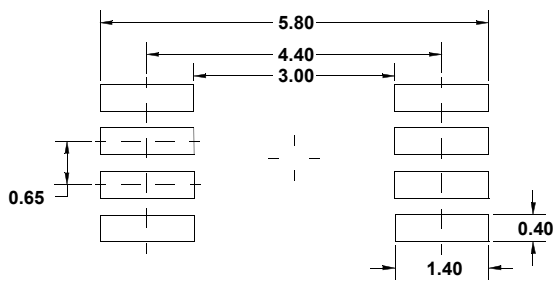

**TYPICAL RECOMMENDED LAND PATTERN**

**NOTES:**

1. Dimensions are in millimeters.
2. Dimensioning and tolerancing conform to JEDEC MO-187-AA and AMSE Y14.5m-1994.
3. Plastic or metal protrusions of 0.15mm max per side are not included.
4. Plastic interlead protrusions of 0.25mm max per side are not included.
5. Dimensions "D" and "E1" are measured at Datum Plane "H".
6. This replaces existing drawing # MDP0043 MSOP 8L.

# Package Outline Drawing

## M8.15E

8 LEAD NARROW BODY SMALL OUTLINE PLASTIC PACKAGE

Rev 0, 08/09

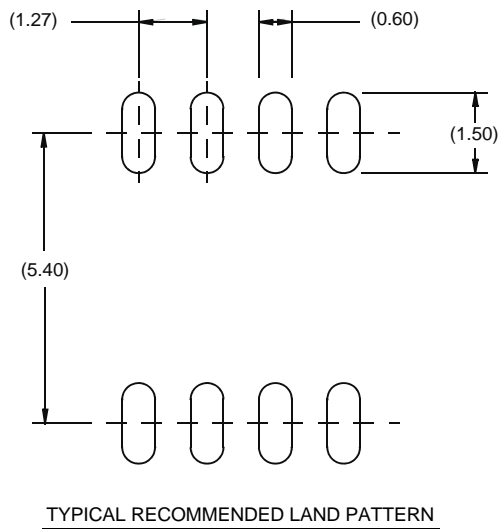
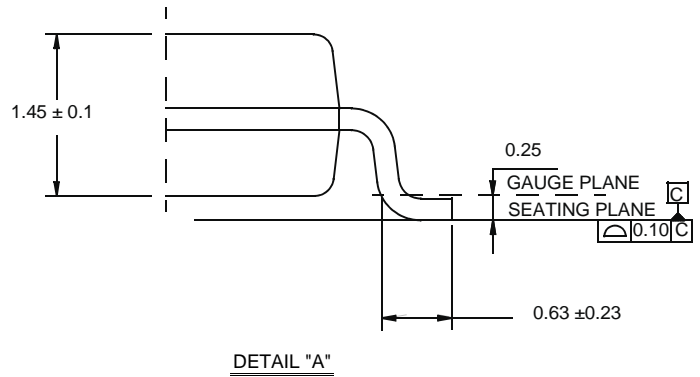
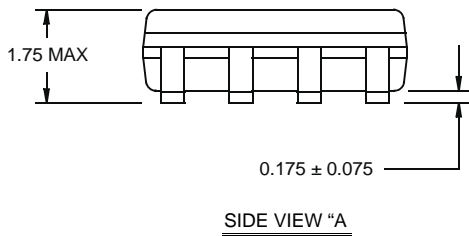
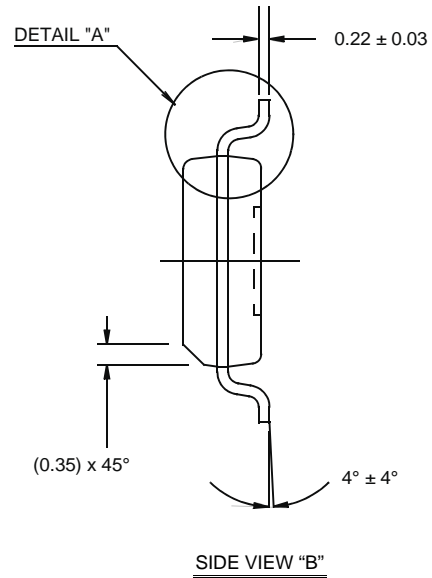
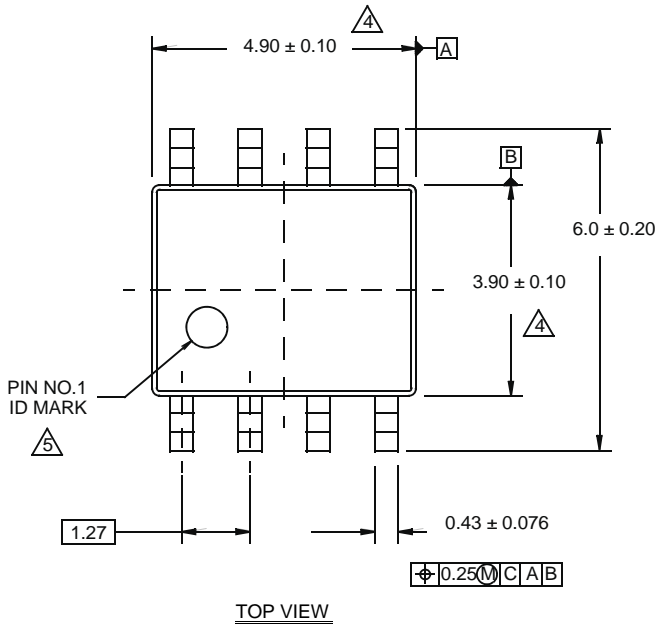

**NOTES:**

1. Dimensions are in millimeters.  
Dimensions in ( ) for Reference Only.
2. Dimensioning and tolerancing conform to AMSE Y14.5m-1994.
3. Unless otherwise specified, tolerance : Decimal ± 0.05
4. Dimension does not include interlead flash or protrusions.  
Interlead flash or protrusions shall not exceed 0.25mm per side.
5. The pin #1 identifier may be either a mold or mark feature.
6. Reference to JEDEC MS-012.

**Small Outline Package Family (SO)**

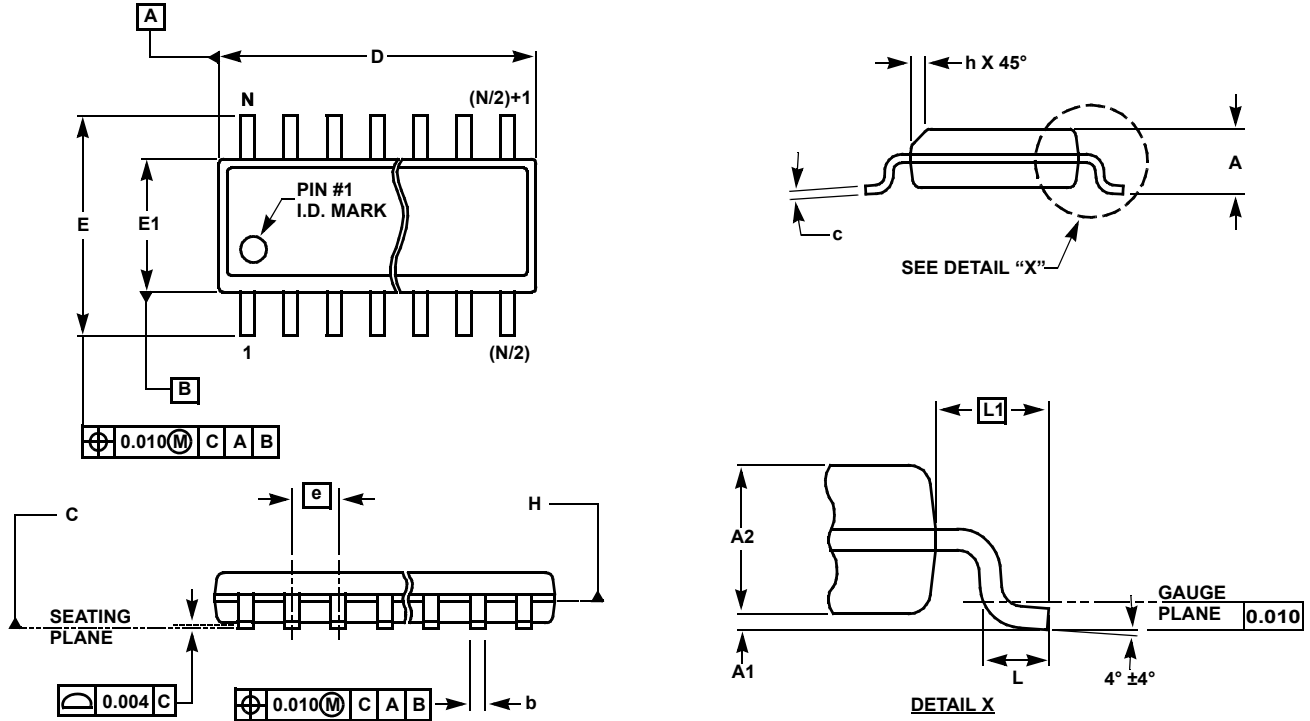

**MDP0027**

**SMALL OUTLINE PACKAGE FAMILY (SO)**

SYMBOL	INCHES							TOLERANCE	NOTES
	SO-8	SO-14	SO16 (0.150")	SO16 (0.300") (SOL-16)	SO20 (SOL-20)	SO24 (SOL-24)	SO28 (SOL-28)		
A	0.068	0.068	0.068	0.104	0.104	0.104	0.104	MAX	-
A1	0.006	0.006	0.006	0.007	0.007	0.007	0.007	±0.003	-
A2	0.057	0.057	0.057	0.092	0.092	0.092	0.092	±0.002	-
b	0.017	0.017	0.017	0.017	0.017	0.017	0.017	±0.003	-
c	0.009	0.009	0.009	0.011	0.011	0.011	0.011	±0.001	-
D	0.193	0.341	0.390	0.406	0.504	0.606	0.704	±0.004	1, 3
E	0.236	0.236	0.236	0.406	0.406	0.406	0.406	±0.008	-
E1	0.154	0.154	0.154	0.295	0.295	0.295	0.295	±0.004	2, 3
e	0.050	0.050	0.050	0.050	0.050	0.050	0.050	Basic	-
L	0.025	0.025	0.025	0.030	0.030	0.030	0.030	±0.009	-
L1	0.041	0.041	0.041	0.056	0.056	0.056	0.056	Basic	-
h	0.013	0.013	0.013	0.020	0.020	0.020	0.020	Reference	-
N	8	14	16	16	20	24	28	Reference	-

Rev. M 2/07

**NOTES:**

1. Plastic or metal protrusions of 0.006" maximum per side are not included.
2. Plastic interlead protrusions of 0.010" maximum per side are not included.
3. Dimensions "D" and "E1" are measured at Datum Plane "H".
4. Dimensioning and tolerancing per ASME Y14.5M-1994

Thin Shrink Small Outline Package Family (TSSOP)

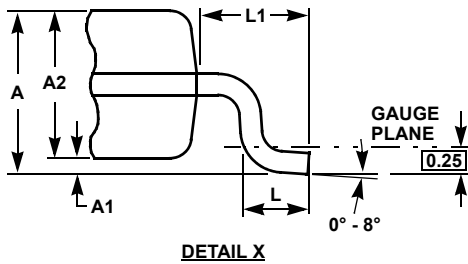
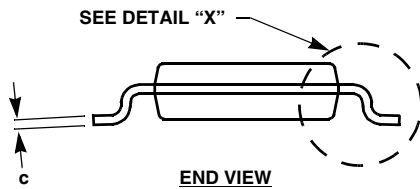
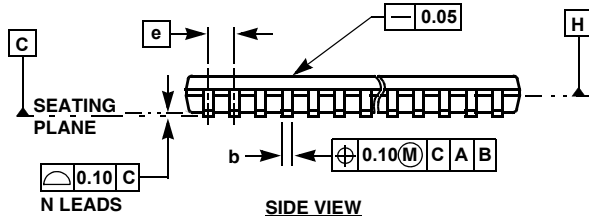
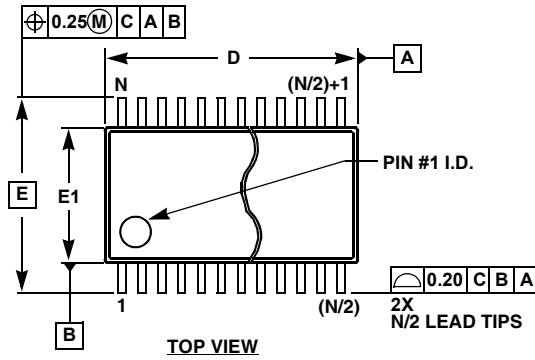

MDP0044

THIN SHRINK SMALL OUTLINE PACKAGE FAMILY

SYMBOL	MILLIMETERS					TOLERANCE
	14 LD	16 LD	20 LD	24 LD	28 LD	
A	1.20	1.20	1.20	1.20	1.20	Max
A1	0.10	0.10	0.10	0.10	0.10	±0.05
A2	0.90	0.90	0.90	0.90	0.90	±0.05
b	0.25	0.25	0.25	0.25	0.25	+0.05/-0.06
c	0.15	0.15	0.15	0.15	0.15	+0.05/-0.06
D	5.00	5.00	6.50	7.80	9.70	±0.10
E	6.40	6.40	6.40	6.40	6.40	Basic
E1	4.40	4.40	4.40	4.40	4.40	±0.10
e	0.65	0.65	0.65	0.65	0.65	Basic
L	0.60	0.60	0.60	0.60	0.60	±0.15
L1	1.00	1.00	1.00	1.00	1.00	Reference

Rev. F 2/07

NOTES:

1. Dimension "D" does not include mold flash, protrusions or gate burrs. Mold flash, protrusions or gate burrs shall not exceed 0.15mm per side.
2. Dimension "E1" does not include interlead flash or protrusions. Interlead flash and protrusions shall not exceed 0.25mm per side.
3. Dimensions "D" and "E1" are measured at dAtum Plane H.
4. Dimensioning and tolerancing per ASME Y14.5M-1994.

For additional products, see [www.intersil.com/product\\_tree](http://www.intersil.com/product_tree)

Intersil products are manufactured, assembled and tested utilizing ISO9000 quality systems as noted in the quality certifications found at [www.intersil.com/design/quality](http://www.intersil.com/design/quality)

Intersil products are sold by description only. Intersil Corporation reserves the right to make changes in circuit design, software and/or specifications at any time without notice. Accordingly, the reader is cautioned to verify that data sheets are current before placing orders. Information furnished by Intersil is believed to be accurate and reliable. However, no responsibility is assumed by Intersil or its subsidiaries for its use; nor for any infringements of patents or other rights of third parties which may result from its use. No license is granted by implication or otherwise under any patent or patent rights of Intersil or its subsidiaries.

For information regarding Intersil Corporation and its products, see [www.intersil.com](http://www.intersil.com)