



### FEATURES

#### Low noise

Input voltage noise: 0.85 nV/ $\sqrt{\text{Hz}}$

Current noise: 2.0 pA/ $\sqrt{\text{Hz}}$

#### High speed

200 MHz bandwidth (G = 12.04 dB)

295 V/ $\mu\text{s}$  slew rate

#### Selectable gain

G = 12.04 dB ( $\times 4$ )

G = 18.06 dB ( $\times 8$ )

G = 21.58 dB ( $\times 12$ )

G = 24.08 dB ( $\times 16$ )

#### Active input impedance matching

#### Integrated input clamp diodes

#### Single-ended input, differential output

#### Supply range: 4.5 V to 5.5 V

#### Low power: 60 mW/channel

### APPLICATIONS

#### CW Doppler ultrasound front ends

#### Low noise preamplification

#### Predriver for I/Q demodulators and phase shifters

#### Wideband analog-to-digital drivers

### GENERAL DESCRIPTION

The AD8432 is a dual-channel, low power, ultralow noise amplifier with selectable gain and active impedance matching. Each channel has a single-ended input, differential output, and integrated input clamps. By pin strapping the gain setting pins, four accurate gains of G = 12.04 dB, 18.06 dB, 21.58 dB, and 24.08 dB ( $\times 4$ ,  $\times 8$ ,  $\times 12$ , and  $\times 16$ , respectively) are possible. A bandwidth of 200 MHz at G = 12.04 dB makes this amplifier well suited for many high speed applications.

The exceptional noise performance of the AD8432 is made possible by the active impedance matching. Using a feedback network, the input impedance of the amplifiers can be adjusted to match the signal source impedance without compromising the noise performance. Impedance matching and low noise in the AD8432 allow designers to create wider dynamic range systems that are able to detect even very low level signals.

### FUNCTIONAL BLOCK DIAGRAM

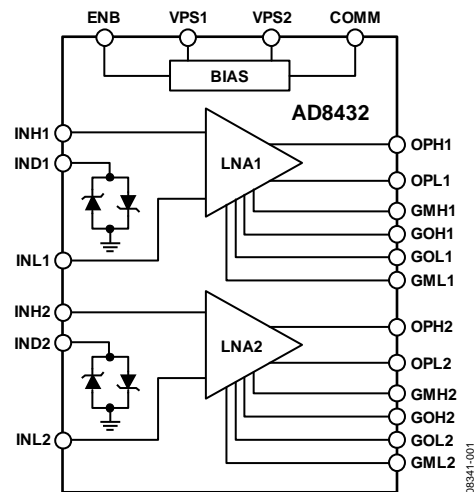

Figure 1.

The AD8432 achieves 0.85 nV/ $\sqrt{\text{Hz}}$  input-referred voltage noise for a gain of 12.04 dB. The AD8432's ultralow noise, low distortion, gain accuracy, and channel-to-channel matching are ideal for high performance ultrasound systems and for processing I/Q demodulator signals.

The AD8432 operates on a single supply of 5 V at 24 mA. It is available in a 4 mm  $\times$  4 mm, 24-lead LFCSP. The LFCSP features an exposed paddle that provides a low thermal resistance path to the PCB, which enables more efficient heat transfer and increases reliability. The operating temperature range is  $-40^{\circ}\text{C}$  to  $+85^{\circ}\text{C}$ .

#### Rev. B

Information furnished by Analog Devices is believed to be accurate and reliable. However, no responsibility is assumed by Analog Devices for its use, nor for any infringements of patents or other rights of third parties that may result from its use. Specifications subject to change without notice. No license is granted by implication or otherwise under any patent or patent rights of Analog Devices. Trademarks and registered trademarks are the property of their respective owners.

One Technology Way, P.O. Box 9106, Norwood, MA 02062-9106, U.S.A.  
Tel: 781.329.4700 [www.analog.com](http://www.analog.com)  
Fax: 781.461.3113 ©2009-2011 Analog Devices, Inc. All rights reserved.

**TABLE OF CONTENTS**

Features .....	1	Gain Setting Technique .....	18
Applications.....	1	Active Input Resistance Matching.....	19
Functional Block Diagram .....	1	Applications Information .....	21
General Description .....	1	Typical Setup.....	21
Revision History .....	2	I/Q Demodulation Front End.....	23
Specifications.....	3	Differential-to-Single-Ended Conversion.....	24
Absolute Maximum Ratings.....	5	Evaluation Board .....	25
Thermal Resistance .....	5	Gain Setting.....	25
Maximum Power Dissipation .....	5	Schematic.....	26
ESD Caution.....	5	Power Supply.....	27
Pin Configuration and Function Descriptions.....	6	Input Termination .....	27
Typical Performance Characteristics .....	7	Output.....	27
Test Circuits.....	16	Outline Dimensions .....	28
Theory of Operation .....	18	Ordering Guide .....	28
Low Noise Amplifier (LNA) .....	18		

**REVISION HISTORY****3/11—Rev. A to Rev. B**

Changes to Format .....	21
-------------------------	----

**2/10—Rev. 0 to Rev. A**

Changes to General Description .....	1
Changes to Figure 5, Figure 6, Figure 7, Figure 8.....	7
Added Figure 27, Figure 29, and Figure 31, Renumbered Sequentially .....	11
Added Figure 33 and Figure 35.....	12
Changes to Figure 58.....	16

**10/09—Revision 0: Initial Version**

## SPECIFICATIONS

$V_S = 5\text{ V}$ ,  $T_A = 25^\circ\text{C}$ ,  $R_S = R_{IN} = 50\ \Omega$ ,  $R_{FB} = 150\ \Omega$ ,  $C_{SH} = 47\ \text{pF}$ ,  $R_{SH} = 15\ \Omega$ ,  $R_L = 500\ \Omega$  (per SE output),  $C_L = 5\ \text{pF}$  (per SE output),  $G = 12.04\ \text{dB}$  (single-ended input to differential output),  $f = 1\ \text{MHz}$ , unless otherwise specified.

Table 1.

Parameter	Conditions	Min	Typ	Max	Unit
<b>DYNAMIC PERFORMANCE</b>					
Gain Range	Input to differential output (selectable gain)	12.04		24.08	dB
	Input to single output (selectable gain)	6.02		18.06	dB
Gain Error			0.1	1	dB
–3 dB Small Signal Bandwidth	$R_{IN}$ unterminated, $R_{FB} = \infty$ , $C_{SH} = 0\ \text{pF}$ , $R_{SH} = 0\ \Omega$				
	$G = 12.04\ \text{dB}$		200		MHz
	$G = 18.06\ \text{dB}$		90		MHz
	$G = 21.58\ \text{dB}$		50		MHz
	$G = 24.08\ \text{dB}$		32		MHz
–3 dB Large Signal Bandwidth	$V_{OUT} = 2\ \text{V p-p}$		42		MHz
Slew Rate (Rising Edge)	$V_{OUT} = 2\ \text{V p-p}$ , $f = 10\ \text{MHz}$		295		V/ $\mu\text{s}$
Slew Rate (Falling Edge)	$V_{OUT} = 2\ \text{V p-p}$ , $f = 10\ \text{MHz}$		170		V/ $\mu\text{s}$
Overdrive Recovery Time			10		ns
<b>DISTORTION/NOISE PERFORMANCE</b>					
Input Voltage Noise	$R_{FB} = \infty$		0.85		nV/ $\sqrt{\text{Hz}}$
Input Current Noise	$R_{FB} = \infty$		2.0		pA/ $\sqrt{\text{Hz}}$
Noise Figure	Unterminated	$R_S = 50\ \Omega$ , $R_{FB} = \infty$	2.8		dB
	Active Termination	$R_S = R_{IN} = 50\ \Omega$ , $R_{FB} = 150\ \Omega$	4.8		dB
		$R_S = 50\ \Omega$ , $R_{FB} = 226\ \Omega$ , $R_{IN} = 75\ \Omega$	4.2		dB
		$R_S = 50\ \Omega$ , $R_{FB} = 301\ \Omega$ , $R_{IN} = 100\ \Omega$	3.2		dB
		$R_S = 50\ \Omega$ , $R_{FB} = 619\ \Omega$ , $R_{IN} = 200\ \Omega$	2.1		dB
		$R_S = 50\ \Omega$ , $R_{FB} = 3.57\ \text{k}\Omega$ , $R_{IN} = 1\ \text{k}\Omega$	2.3		dB
		Output Referred Noise	$G = 12.04\ \text{dB}$ , $R_{FB} = \infty$		3.4
$G = 18.06\ \text{dB}$ , $R_{FB} = \infty$			6.8		nV/ $\sqrt{\text{Hz}}$
$G = 21.58\ \text{dB}$ , $R_{FB} = \infty$			10.2		nV/ $\sqrt{\text{Hz}}$
$G = 24.08\ \text{dB}$ , $R_{FB} = \infty$			13.6		nV/ $\sqrt{\text{Hz}}$
Harmonic Distortion	1 MHz ( $V_{OUT} = 1\ \text{V p-p}$ )	HD2	–67		dBc
		HD2, $R_S = 50\ \Omega$ , $R_{IN}$ unterminated	–74		dBc
		HD3	–103		dBc
	1 MHz ( $V_{OUT} = 2\ \text{V p-p}$ )	HD3, $R_S = 50\ \Omega$ , $R_{IN}$ unterminated	–106		dBc
		HD2	–65		dBc
		HD2, $R_S = 50\ \Omega$ , $R_{IN}$ unterminated	–72		dBc
	10 MHz ( $V_{OUT} = 1\ \text{V p-p}$ )	HD3	–103		dBc
		HD3, $R_S = 50\ \Omega$ , $R_{IN}$ unterminated	–92		dBc
		HD2	–66		dBc
	10 MHz ( $V_{OUT} = 2\ \text{V p-p}$ )	HD2, $R_S = 50\ \Omega$ , $R_{IN}$ unterminated	–62		dBc
		HD3	–78		dBc
		HD3, $R_S = 50\ \Omega$ , $R_{IN}$ unterminated	–73		dBc
10 MHz ( $V_{OUT} = 2\ \text{V p-p}$ )	HD2	–60		dBc	
	HD2, $R_S = 50\ \Omega$ , $R_{IN}$ unterminated	–56		dBc	
	HD3	–72		dBc	
	HD3, $R_S = 50\ \Omega$ , $R_{IN}$ unterminated	–65		dBc	

# AD8432

Parameter	Conditions	Min	Typ	Max	Unit
Two-Tone IMD3 Distortion	$R_S = 50 \Omega$ , $R_{IN}$ unterminated				
10 MHz	$V_{OUT} = 1 \text{ V p-p}$ , $f_1 = 9.5 \text{ MHz}$ , $f_2 = 10.5 \text{ MHz}$		-89.1		dBc
	$V_{OUT} = 2 \text{ V p-p}$ , $f_1 = 9.5 \text{ MHz}$ , $f_2 = 10.5 \text{ MHz}$		-66.0		dBc
1 MHz	$V_{OUT} = 1 \text{ V p-p}$ , $f_1 = 0.9 \text{ MHz}$ , $f_2 = 1.1 \text{ MHz}$		-88.9		dBc
	$V_{OUT} = 2 \text{ V p-p}$ , $f_1 = 0.9 \text{ MHz}$ , $f_2 = 1.1 \text{ MHz}$		-73.7		dBc
Input 1dB Compression Point	$f = 1 \text{ MHz}$		7.5		dBm
	$f = 10 \text{ MHz}$		7.7		dBm
Output Third-Order Intercept					
1 MHz	$V_{OUT} = 1 \text{ V p-p}$ of composite tones		29.7		dBV rms
	$V_{OUT} = 2 \text{ V p-p}$ of composite tones		28.2		dBV rms
10 MHz	$V_{OUT} = 1 \text{ V p-p}$ of composite tones		23.2		dBV rms
	$V_{OUT} = 2 \text{ V p-p}$ of composite tones		24.2		dBV rms
1 MHz	$V_{OUT} = 1 \text{ V p-p}$ of composite tones, reference to $50 \Omega$		42.7		dBm
	$V_{OUT} = 2 \text{ V p-p}$ of composite tones, reference to $50 \Omega$		41.2		dBm
10 MHz	$V_{OUT} = 1 \text{ V p-p}$ of composite tones, reference to $50 \Omega$		36.2		dBm
	$V_{OUT} = 2 \text{ V p-p}$ of composite tones, reference to $50 \Omega$		37.2		dBm
Crosstalk	$V_{OUT} = 1 \text{ V p-p}$ , $f = 1 \text{ MHz}$		102		dB
<b>DC PERFORMANCE</b>					
Input Offset Voltage		-6.25	+1	+6.25	mV
Input Offset Voltage Drift			300		$\mu\text{V}/^\circ\text{C}$
<b>INPUT CHARACTERISTICS</b>					
Input Voltage Range	AC-coupled		1.2		V p-p
Input Resistance	$R_{FB} = 150 \Omega$		50		$\Omega$
	$R_{FB} = 226 \Omega$		75		$\Omega$
	$R_{FB} = 301 \Omega$		100		$\Omega$
	$R_{FB} = 619 \Omega$		200		$\Omega$
	$R_{FB} = 3.57 \text{ k}\Omega$		1		k $\Omega$
	$R_{FB} = \infty$ , $f = 100 \text{ kHz}$		6.2		k $\Omega$
Input Capacitance			6		pF
Input Common-Mode Voltage			3.25		V
<b>OUTPUT CHARACTERISTICS</b>					
Output Common-Mode Voltage			2.5		V
Output Offset Voltage		-25	+4	+25	mV
Output Voltage Swing			4.8		V p-p
Output Resistance	Single-ended, either output		<0.1		$\Omega$
Output Resistance in Shutdown Mode	Single-ended, either output		2.5		k $\Omega$
Output Short-Circuit Current	$R_L = 10 \Omega$ differential		77		mA
Enable Response Time	ENB <sub>ON</sub> (enable high to output on)		200		$\mu\text{s}$
	ENB <sub>OFF</sub> (enable low to output off)		200		$\mu\text{s}$
<b>POWER SUPPLY</b>					
Supply Voltage		4.5	5	5.5	V
Quiescent Current	ENB = 5 V		24		mA
Over Temperature	$T_A = -40^\circ\text{C}$		21		mA
	$T_A = +85^\circ\text{C}$		27		mA
Supply Current in Shutdown Mode	ENB = GND		50	100	$\mu\text{A}$
Power Dissipation			120		mW
PSRR	$G = 24.08 \text{ dB}$ , $f = 100 \text{ kHz}$ , no bypass capacitors		-82		dB

## ABSOLUTE MAXIMUM RATINGS

Table 2.

Parameter	Rating
Voltage	
Supply Voltage	5.5 V
Input Voltage	0 V to VPS
Power Dissipation	120 mW
Temperature	
Operating Temperature	-40°C to +85°C
Storage Temperature	-65°C to +150°C
Package Glass Transition Temperature (T <sub>G</sub> )	150°C
Lead Temperature (Soldering, 60 sec)	300°C

Stresses above those listed under Absolute Maximum Ratings may cause permanent damage to the device. This is a stress rating only; functional operation of the device at these or any other conditions above those indicated in the operational section of this specification is not implied. Exposure to absolute maximum rating conditions for extended periods may affect device reliability.

### THERMAL RESISTANCE

$\theta_{JA}$  is specified for the worst-case conditions, that is, a device soldered in a circuit board for surface-mount packages. The  $\theta_{JA}$  value in Table 3 assumes a 4-layer JEDEC standard board with zero airflow.

Table 3. Thermal Resistance<sup>1</sup>

Parameter	$\theta_{JA}$	$\theta_{JC}$	$\theta_{JB}$	$\Psi_{JT}$	Unit
40-Lead LFCSP	57.9	11.2	35.9	1.1	°C/W

<sup>1</sup> 4-layer JEDEC board (2S2P).

### MAXIMUM POWER DISSIPATION

The maximum safe power dissipation for the AD8432 is limited by the associated rise in junction temperature (T<sub>J</sub>) on the die. At approximately 150°C, which is the glass transition temperature, the properties of the plastic change. Even temporarily exceeding this temperature limit may change the stresses that the package exerts on the die, permanently shifting the parametric performance of the amplifiers. Exceeding a temperature of 150°C for an extended period can cause changes in silicon devices, potentially resulting in a loss of functionality.

### ESD CAUTION



**ESD (electrostatic discharge) sensitive device.** Charged devices and circuit boards can discharge without detection. Although this product features patented or proprietary protection circuitry, damage may occur on devices subjected to high energy ESD. Therefore, proper ESD precautions should be taken to avoid performance degradation or loss of functionality.

## PIN CONFIGURATION AND FUNCTION DESCRIPTIONS

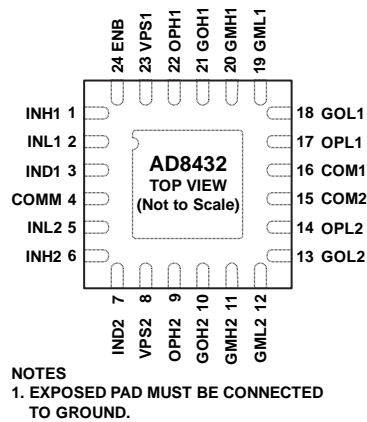

Figure 2. Pin Configuration

Table 4. Pin Function Descriptions

Pin No.	Mnemonic	Description
1	INH1	LNA1 Noninverting Input.
2	INL1	LNA1 Inverting Input (AC-Coupled to Ground).
3, 7	IND1, IND2	Integrated Input Clamping Back-to-Back Diodes.
4	COMM	Input Ground.
5	INL2	LNA2 Inverting Input (AC-Coupled to Ground).
6	INH2	LNA2 Noninverting Input.
8	VPS2	5 V Supply.
9	OPH2	Noninverting Output of LNA2.
10	GOH2	Gain Setting Pin for LNA2.
11	GMH2	Gain Setting Pin for LNA2.
12	GML2	Gain Setting Pin for LNA2.
13	GOL2	Gain Setting Pin for LNA2.
14	OPL2	Inverting Output of LNA2.
15	COM2	LNA2 Output Ground.
16	COM1	LNA1 Output Ground.
17	OPL1	Inverting Output of LNA1.
18	GOL1	Gain Setting Pin for LNA1.
19	GML1	Gain Setting Pin for LNA1.
20	GMH1	Gain Setting Pin for LNA1.
21	GOH1	Gain Setting Pin for LNA1.
22	OPH1	Noninverting Output of LNA1.
23	VPS1	5 V Supply.
24	ENB	Enable.
	EPAD	Exposed pad must be connected to ground.

# TYPICAL PERFORMANCE CHARACTERISTICS

$V_S = 5\text{ V}$ ,  $T_A = 25^\circ\text{C}$ ,  $R_S = R_{IN} = 50\ \Omega$ ,  $R_{FB} = 150\ \Omega$ ,  $C_{SH} = 47\text{ pF}$ ,  $R_{SH} = 15\ \Omega$ ,  $R_L = 500\ \Omega$  (per SE output),  $C_L = 5\text{ pF}$  (per SE output),  $G = 12.04\text{ dB}$  (single-ended input to differential output),  $f = 1\text{ MHz}$ , unless otherwise specified.

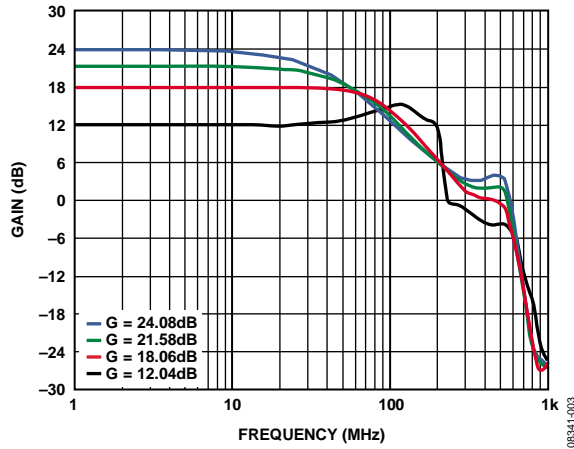

Figure 3. Small Signal Differential Gain vs. Frequency,  $R_{IN}$  Unterminated

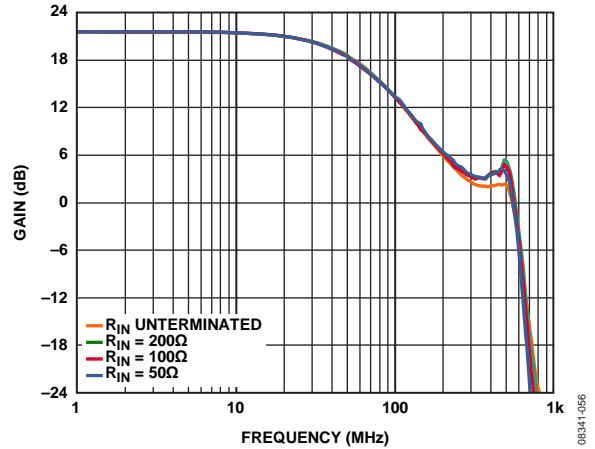

Figure 6. Small Signal Frequency Response vs.  $R_{IN}$ ,  $G = 21.58\text{ dB}$

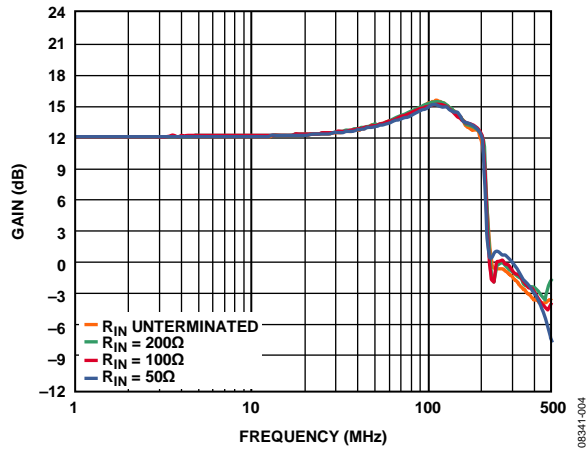

Figure 4. Small Signal Frequency Response vs.  $R_{IN}$ ,  $G = 12.04\text{ dB}$

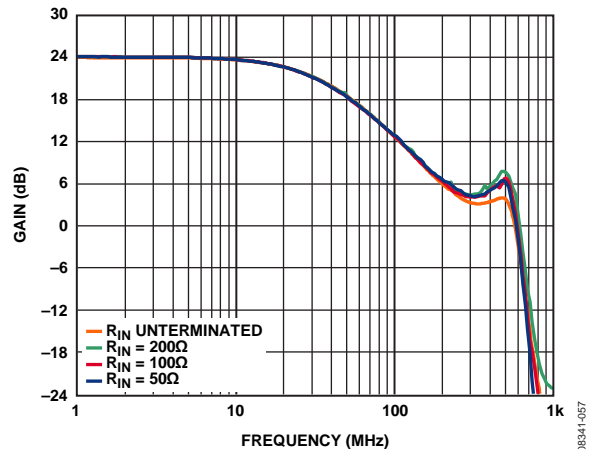

Figure 7. Small Signal Frequency Response vs.  $R_{IN}$ ,  $G = 24.08\text{ dB}$

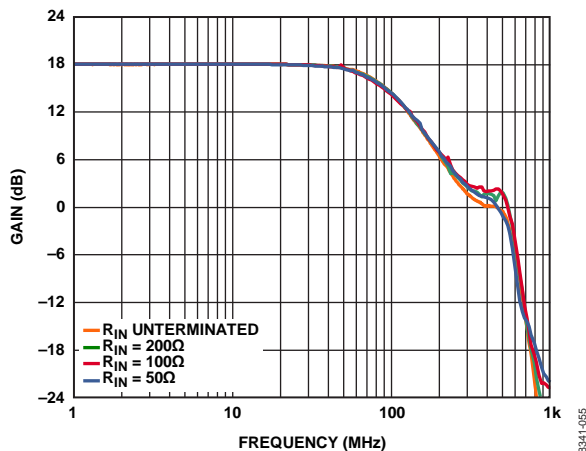

Figure 5. Small Signal Frequency Response vs.  $R_{IN}$ ,  $G = 18.06\text{ dB}$

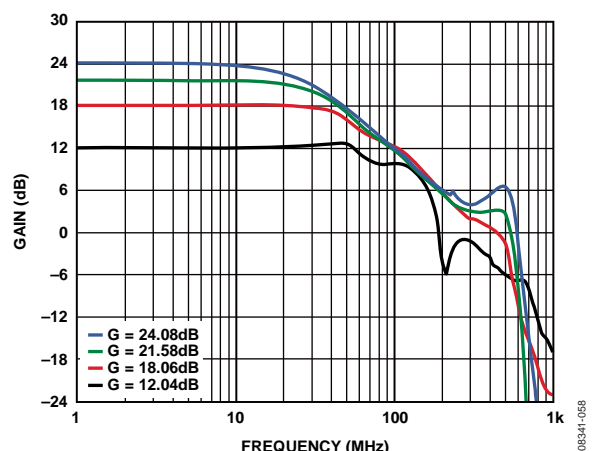

Figure 8. Differential Gain vs. Frequency,  $V_{OUT} = 1\text{ V p-p}$ ,  $R_{IN} = 50\ \Omega$

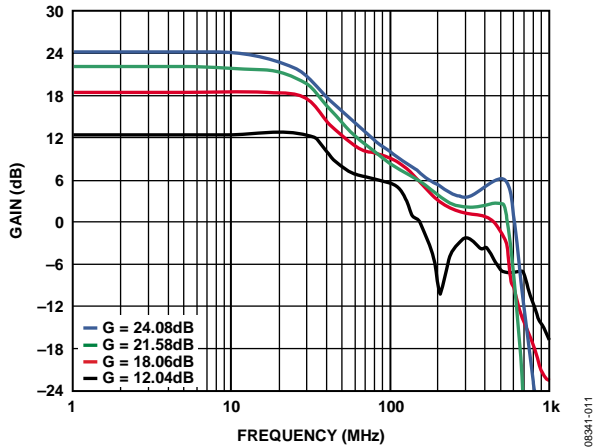

Figure 9. Differential Gain vs. Frequency,  $V_{OUT} = 2\text{ V p-p}$ ,  $R_{IN} = 50\ \Omega$

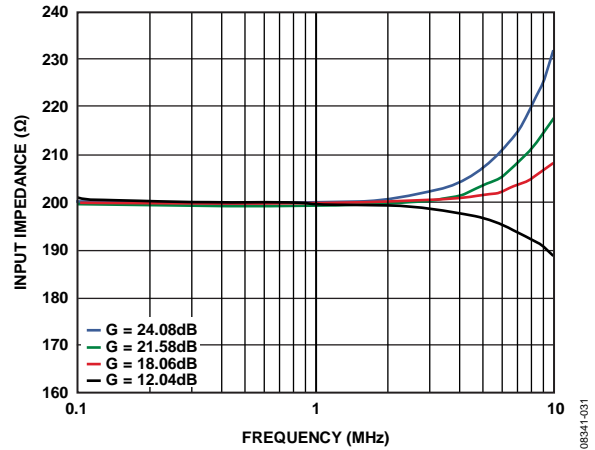

Figure 12. Input Impedance  $R_{IN}$  vs. Frequency,  $200\ \Omega$  Active Termination

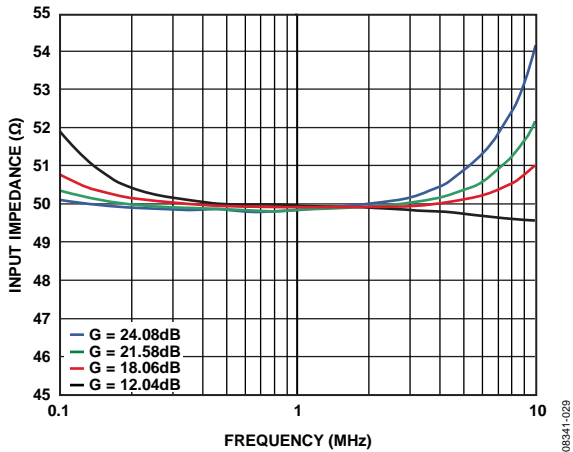

Figure 10. Input Impedance  $R_{IN}$  vs. Frequency,  $50\ \Omega$  Active Termination

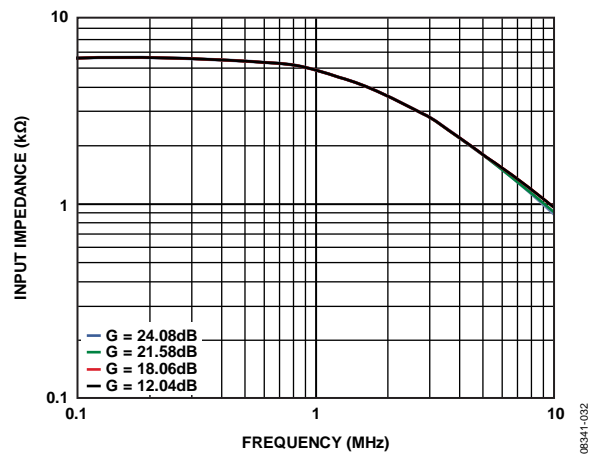

Figure 13. Input Impedance  $R_{IN}$  vs. Frequency, Underterminated

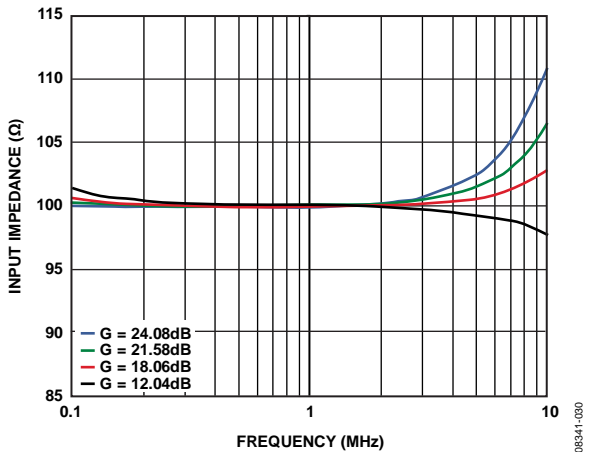

Figure 11. Input Impedance  $R_{IN}$  vs. Frequency,  $100\ \Omega$  Active Termination

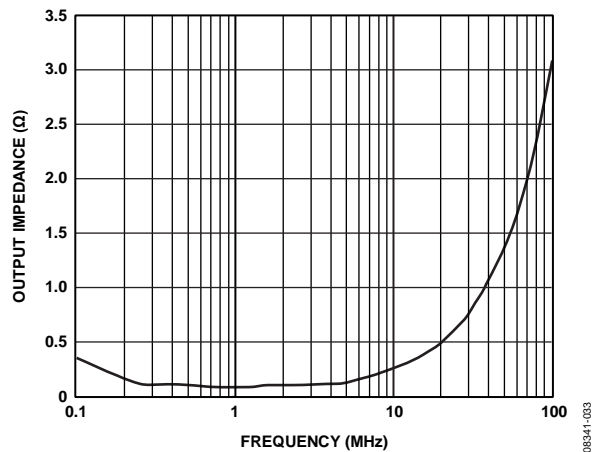

Figure 14. Output Impedance vs. Frequency



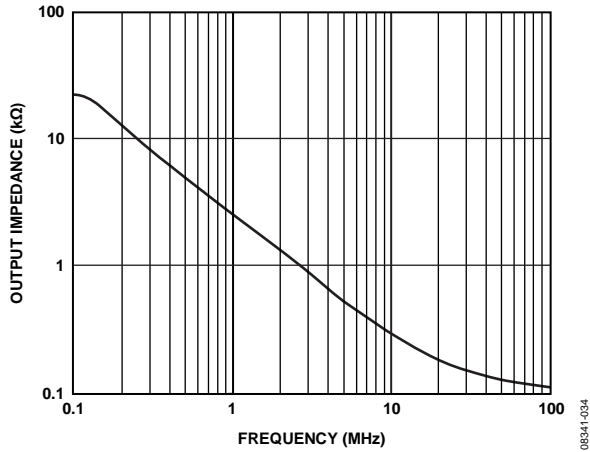

Figure 15. Output Impedance vs. Frequency in Disable Mode

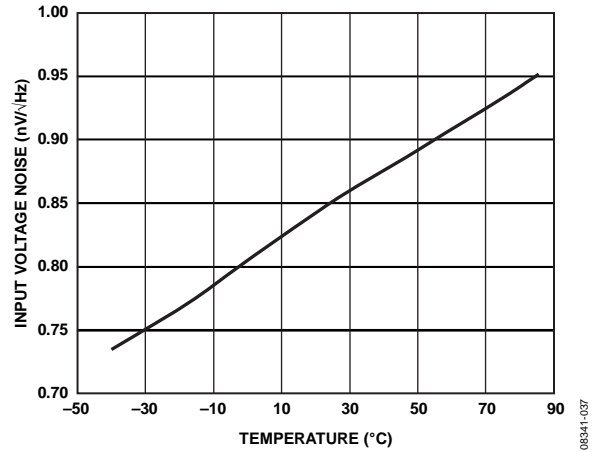

Figure 18. Input Voltage Noise vs. Temperature

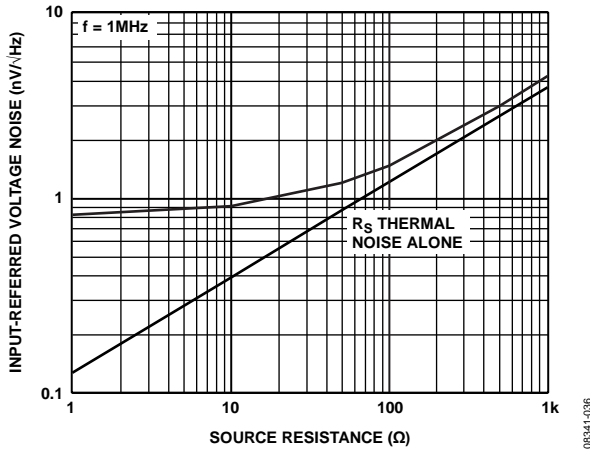

Figure 16. Input-Referred Voltage Noise vs. Source Resistance ( $R_S$ )

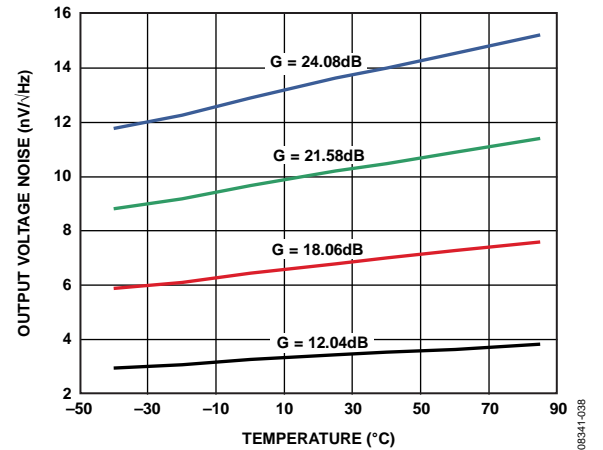

Figure 19. Output Voltage Noise vs. Temperature

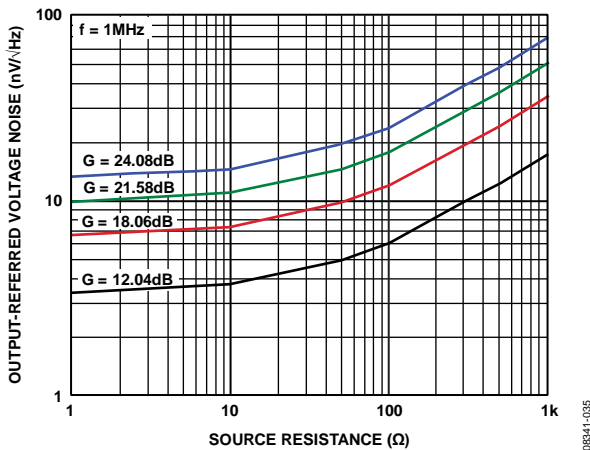

Figure 17. Output-Referred Voltage Noise vs. Source Resistance ( $R_S$ )

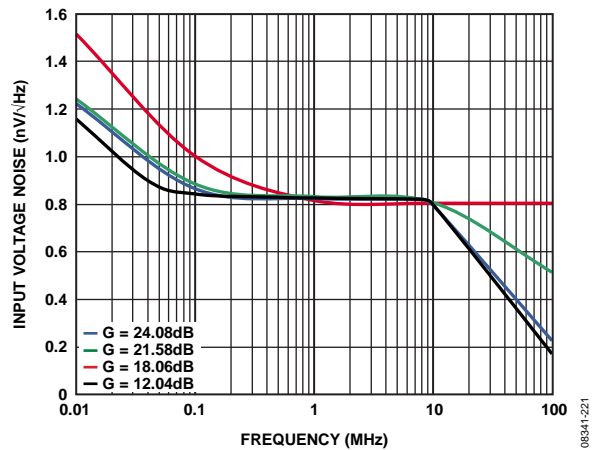

Figure 20. Input Voltage Noise vs. Frequency

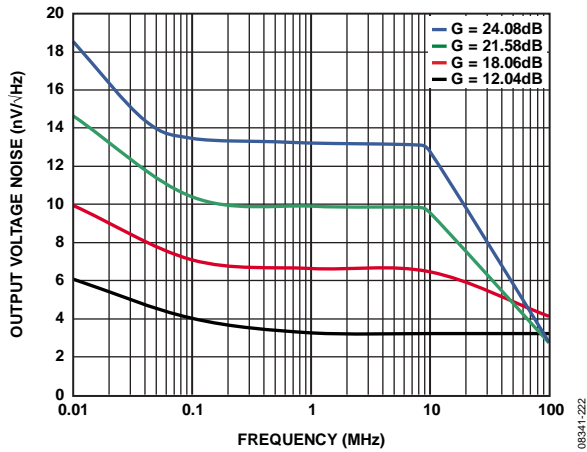

Figure 21. Output Voltage Noise vs. Frequency

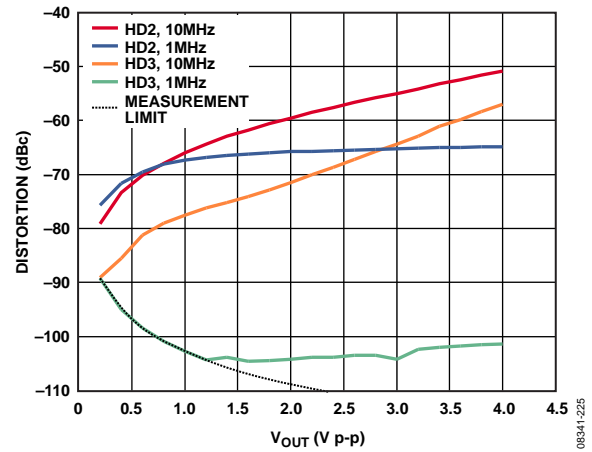

Figure 24. Harmonic Distortion vs. Differential Output Voltage,  $G = 12.04$  dB

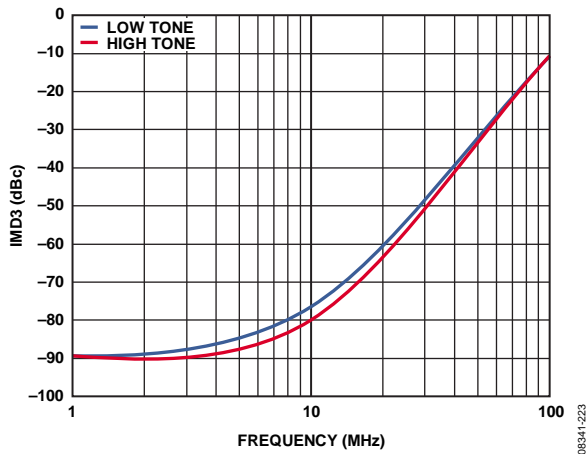

Figure 22. IMD3 vs. Frequency

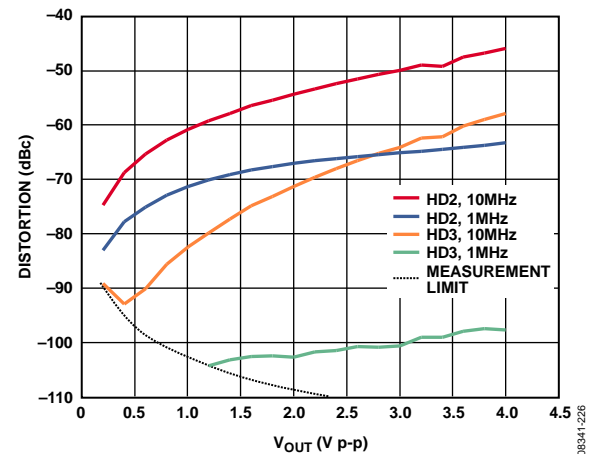

Figure 25. Harmonic Distortion vs. Differential Output Voltage,  $G = 24.08$  dB

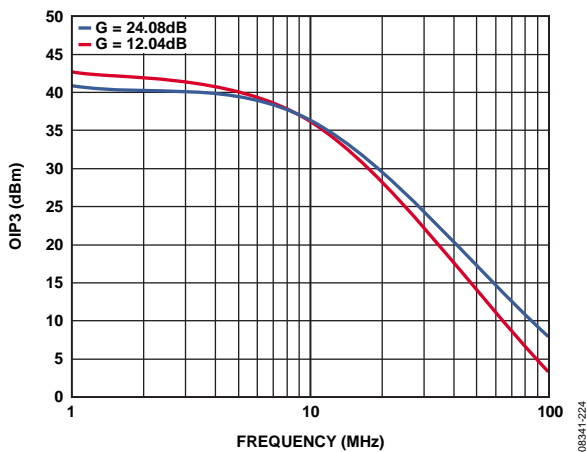

Figure 23. Output Third-Order Intercept vs. Frequency

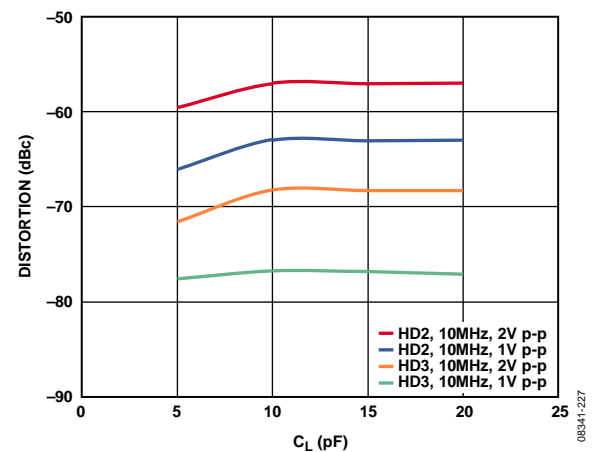

Figure 26. Harmonic Distortion at 10 MHz vs. Capacitive Load ( $C_L$ ),  $G = 12.04$  dB

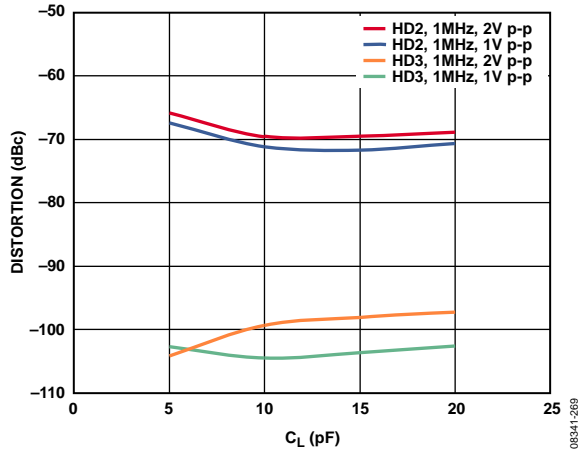

Figure 27. Harmonic Distortion at 1 MHz vs. Capacitive Load ( $C_L$ ),  $G = 12.04$  dB

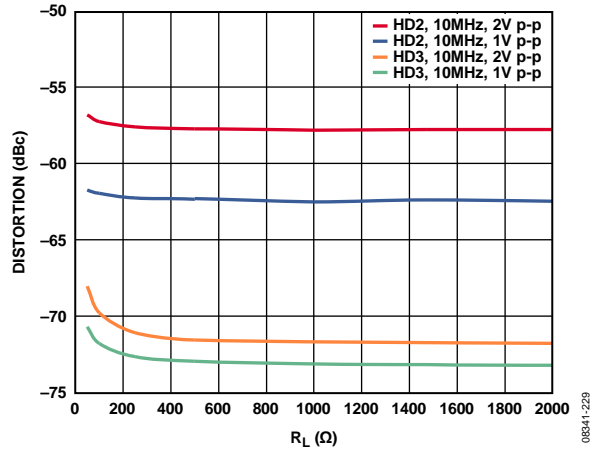

Figure 30. Harmonic Distortion at 10 MHz vs. Resistive Load ( $R_L$ ),  $G = 12.04$  dB

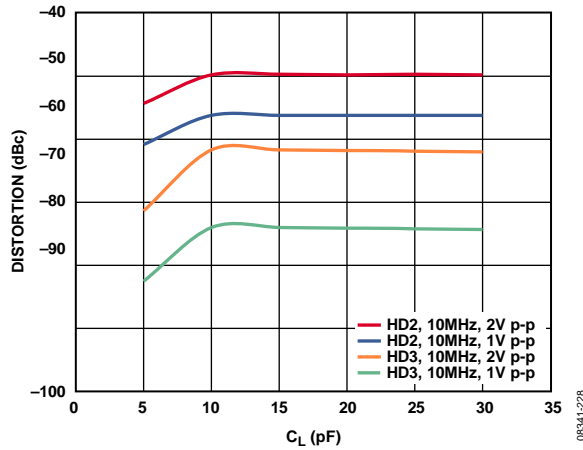

Figure 28. Harmonic Distortion at 10 MHz vs. Capacitive Load ( $C_L$ ),  $G = 24.08$  dB

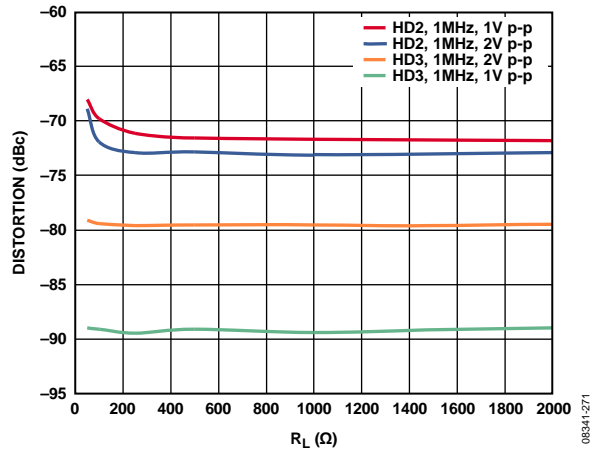

Figure 31. Harmonic Distortion at 1 MHz vs. Resistive Load ( $R_L$ ),  $G = 12.04$  dB

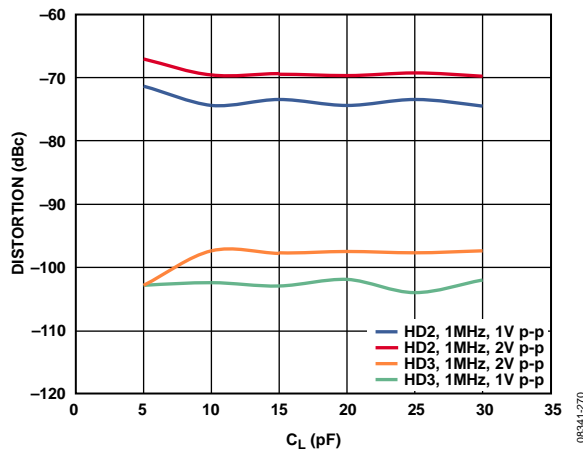

Figure 29. Harmonic Distortion at 1 MHz vs. Capacitive Load ( $C_L$ ),  $G = 24.08$  dB

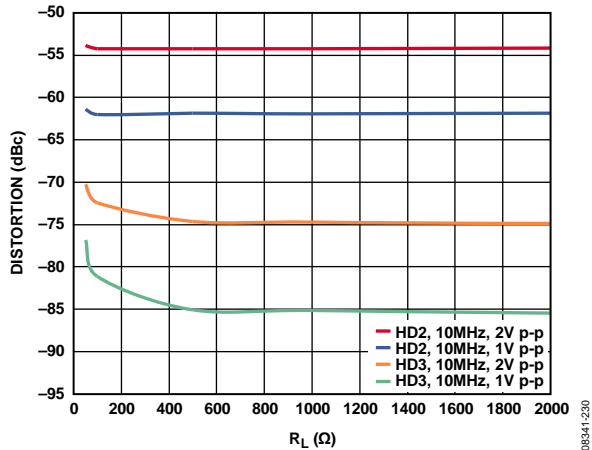

Figure 32. Harmonic Distortion at 10 MHz vs. Resistive Load ( $R_L$ ),  $G = 24.08$  dB

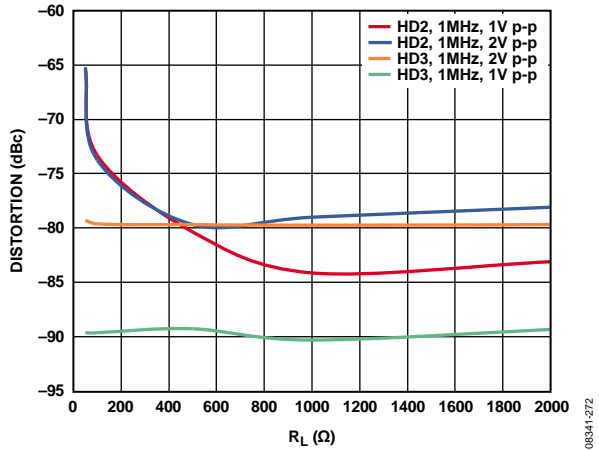

Figure 33. Harmonic Distortion at 1 MHz vs. Resistive Load ( $R_L$ ),  $G = 24.08$  dB

08341-272

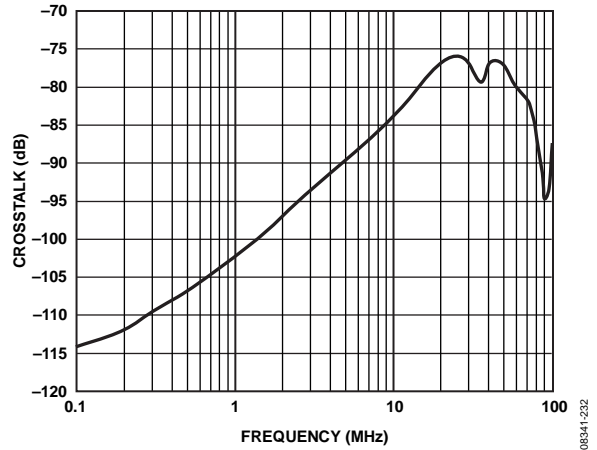

Figure 36. Channel Crosstalk vs. Frequency

08341-232

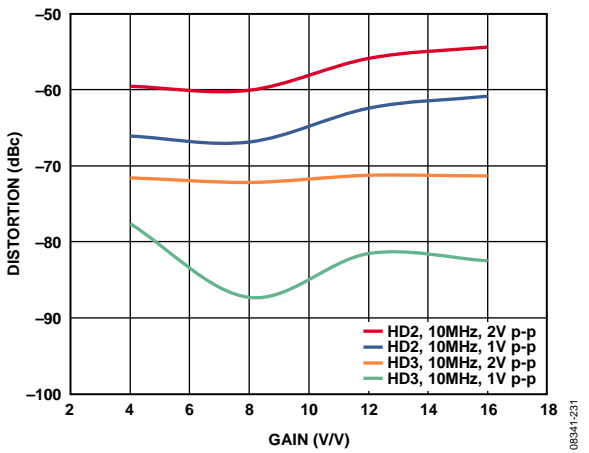

Figure 34. Harmonic Distortion at 10 MHz vs. Gain

08341-231

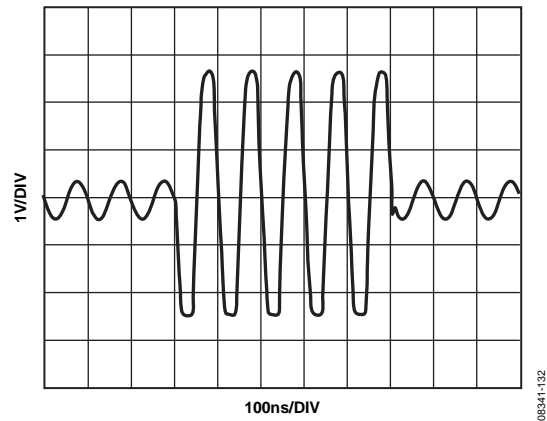

Figure 37. Overdrive Recovery,  $G = 12.04$  dB

08341-132

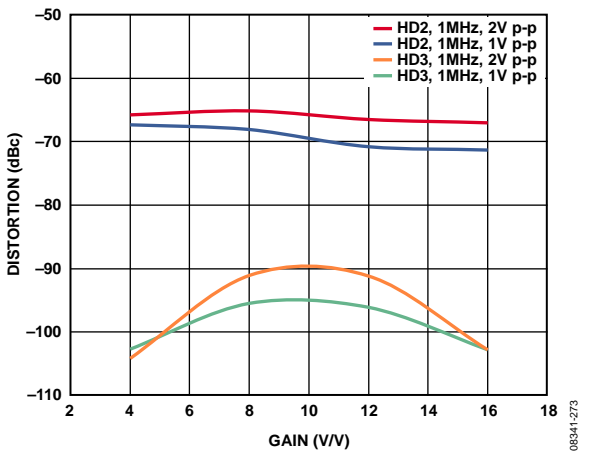

Figure 35. Harmonic Distortion at 1 MHz vs. Gain

08341-273

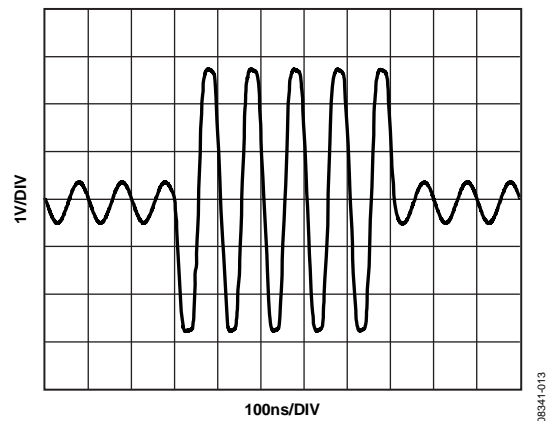

Figure 38. Overdrive Recovery,  $G = 24.08$  dB

08341-013

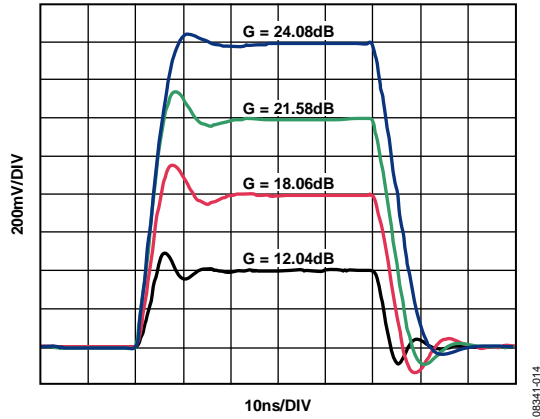

Figure 39. Small Signal Transient Response vs. Gain,  $V_{IN} = 100\text{ mV p-p}$

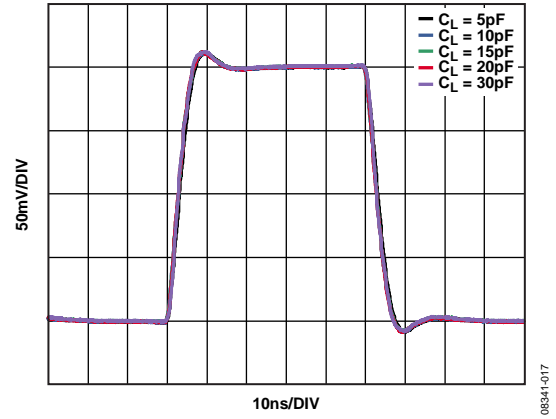

Figure 42. Small Signal Transient Response vs. Capacitive Load ( $C_L$ ),  $G = 24.08\text{ dB}$



Figure 40. Small Signal Transient Response,  $G = 12.04\text{ dB}$

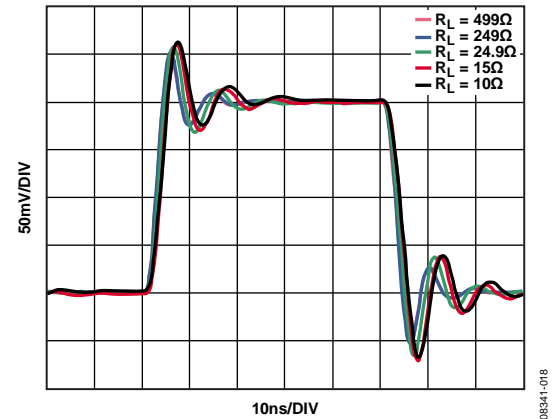

Figure 43. Small Signal Transient Response vs. Resistive Load ( $R_L$ ),  $G = 12.04\text{ dB}$

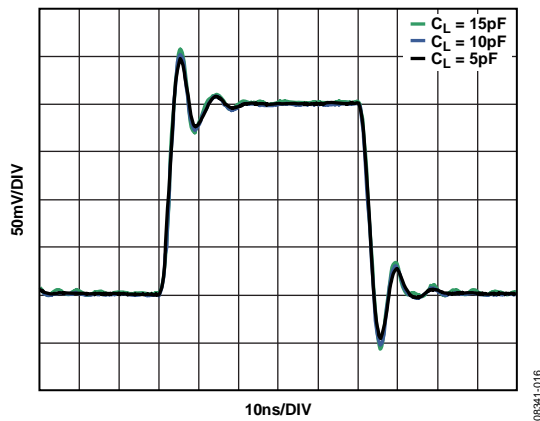

Figure 41. Small Signal Transient Response vs. Capacitive Load ( $C_L$ ),  $G = 12.04\text{ dB}$

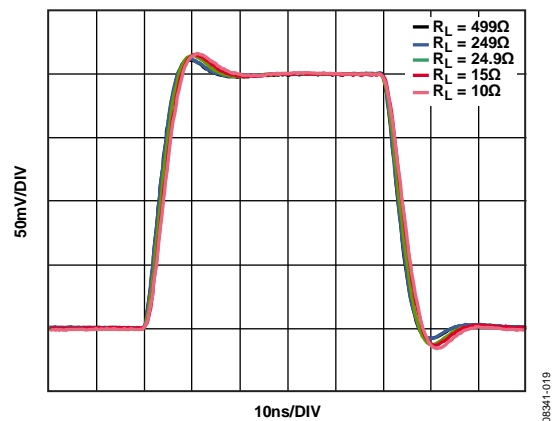

Figure 44. Small Signal Transient Response vs. Resistive Load ( $R_L$ ),  $G = 24.08\text{ dB}$

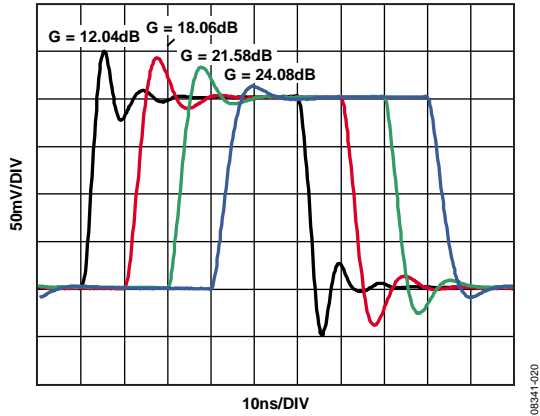

Figure 45. Small Signal Transient Response vs. Gain,  $V_{OUT} = 200\text{ mV p-p}$

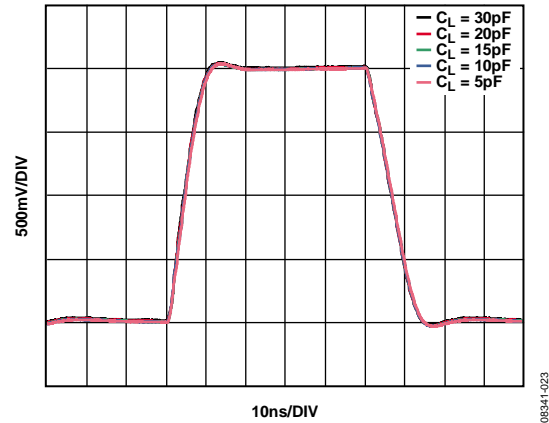

Figure 48. Large Signal Transient Response vs. Capacitive Load ( $C_L$ ),  $G = 24.08\text{ dB}$

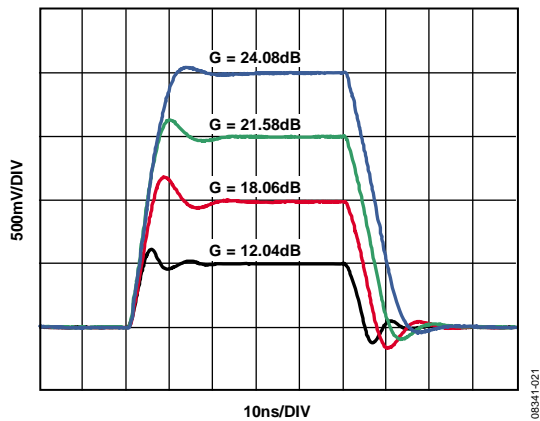

Figure 46. Large Signal Transient Response vs. Gain,  $V_{IN} = 125\text{ mV p-p}$

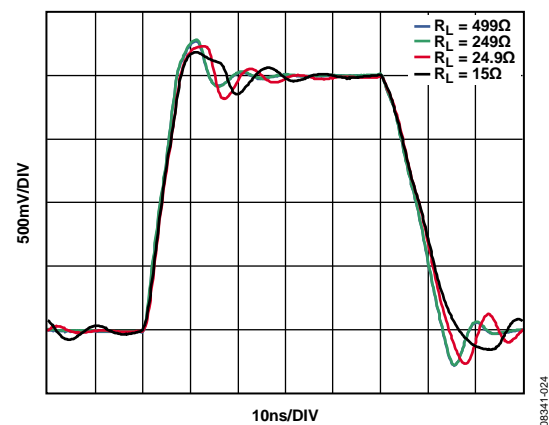

Figure 49. Large Signal Transient Response vs. Resistive Load ( $R_L$ ),  $G = 12.04\text{ dB}$

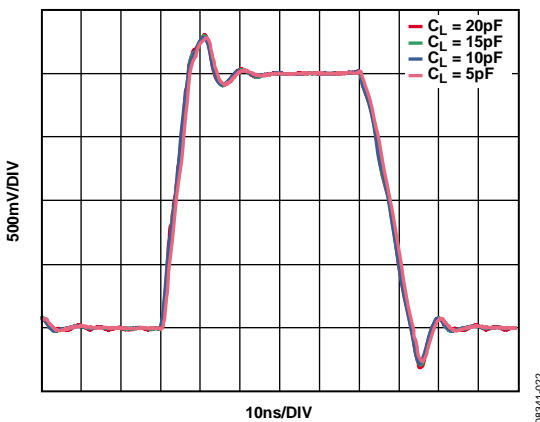

Figure 47. Large Signal Transient Response vs. Capacitive Load ( $C_L$ ),  $G = 12.04\text{ dB}$

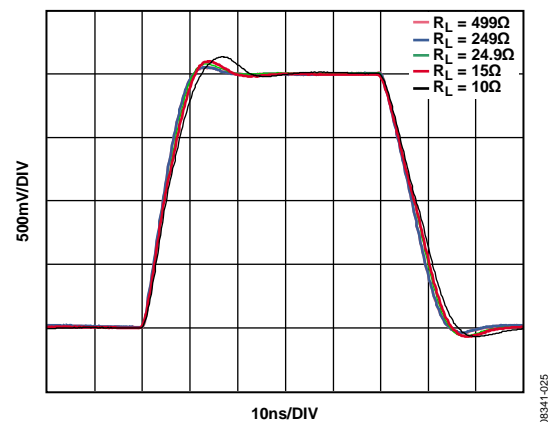

Figure 50. Large Signal Transient Response vs. Resistive Load ( $R_L$ ),  $G = 24.08\text{ dB}$

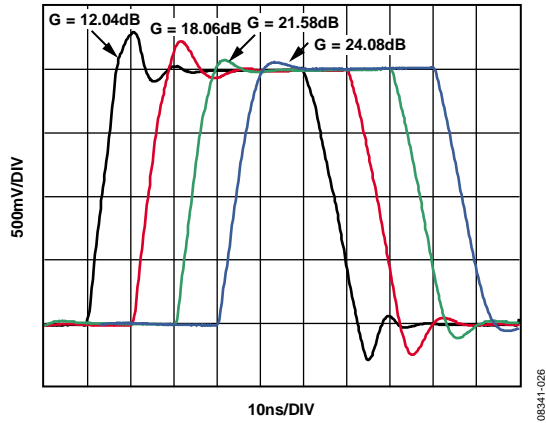

Figure 51. Large Signal Transient Response vs. Gain,  $V_{OUT} = 2V_{p-p}$

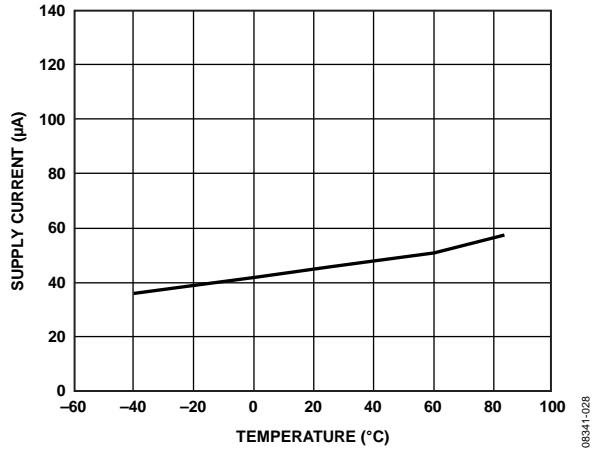

Figure 54. Supply Current vs. Temperature in Disable Mode

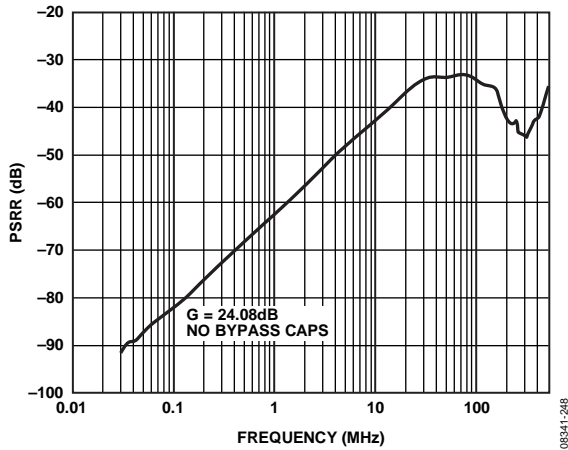

Figure 52. PSRR vs. Frequency

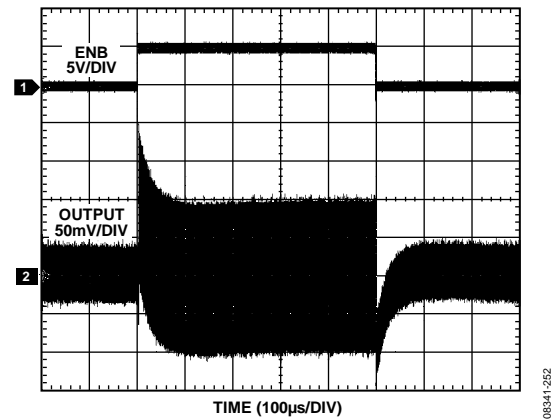

Figure 55. Small Signal Enable Response

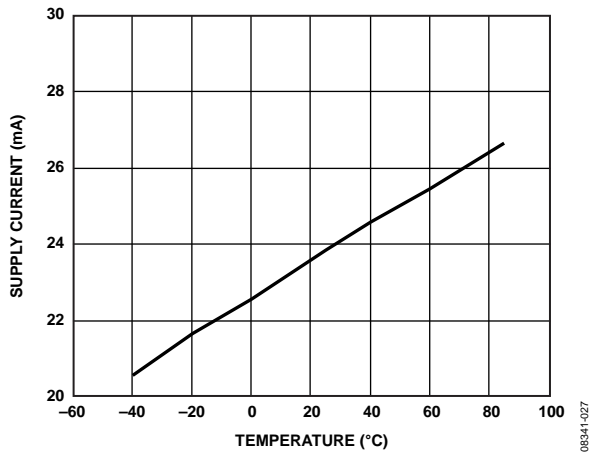

Figure 53. Supply Current vs. Temperature

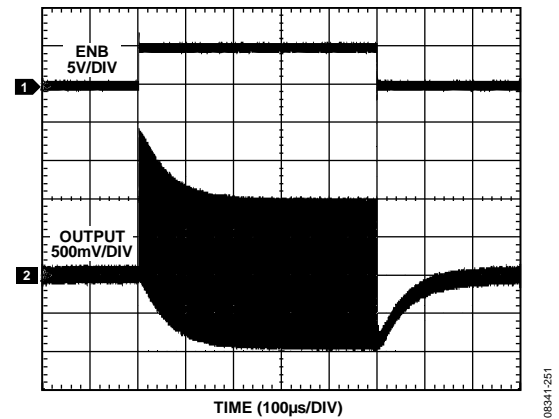

Figure 56. Large Signal Enable Response

## TEST CIRCUITS

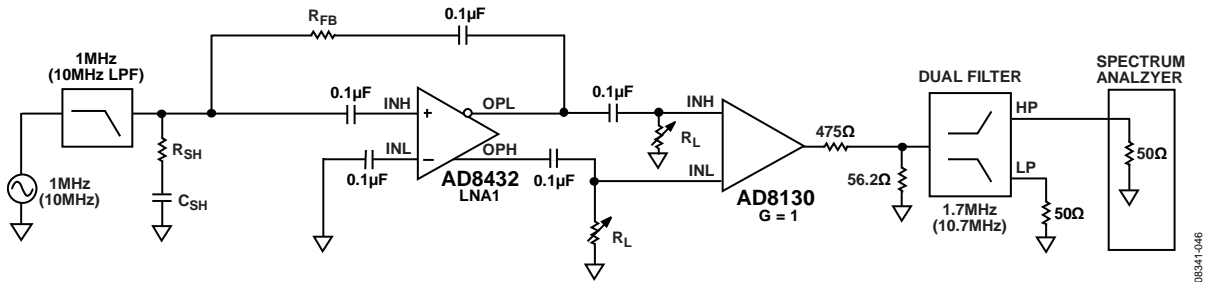

Figure 57. Harmonic Distortion vs. Resistive Load ( $R_L$ ) Measurements

08341-046

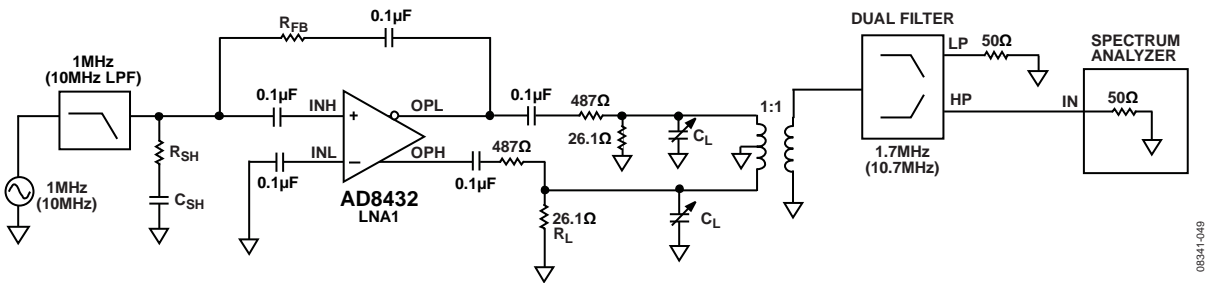

Figure 58. Harmonic Distortion vs. Capacitive Load ( $C_L$ ) Measurements

08341-049

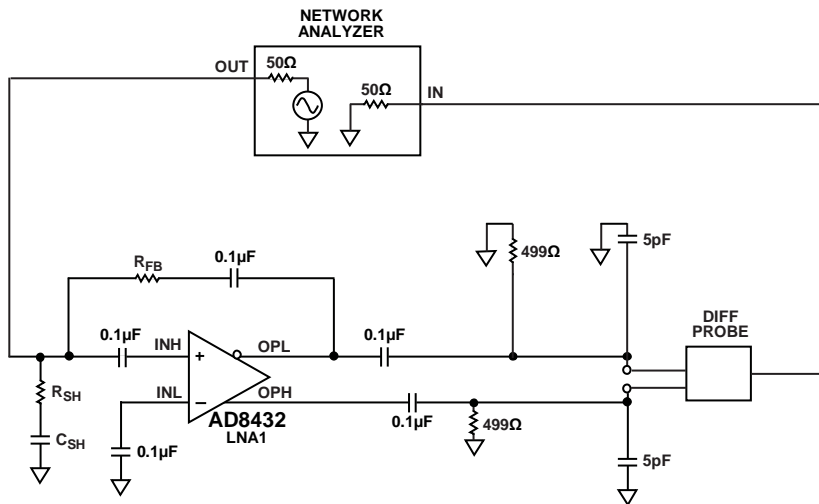

Figure 59. Frequency Response Measurements

08341-047

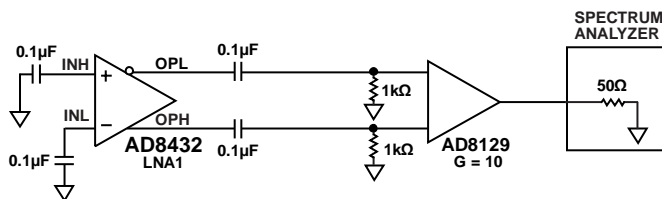

Figure 60. Voltage Noise Measurements

08341-048



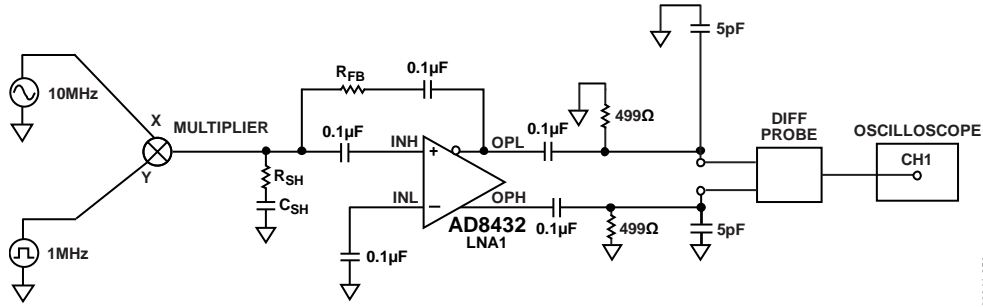

Figure 61. Overdrive Recovery Measurements

08341-050

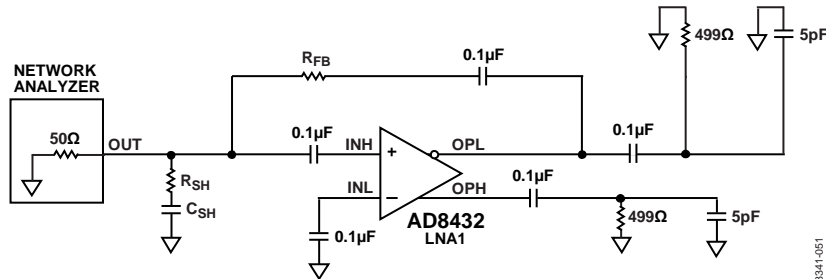

Figure 62. Input Impedance vs. Frequency Measurements

08341-051

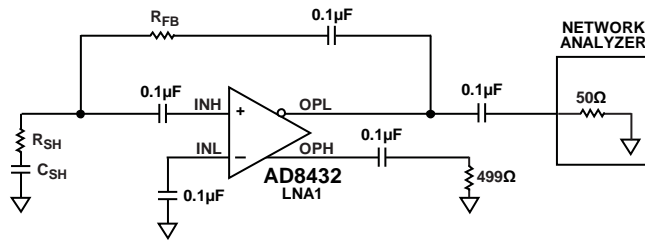

Figure 63. Output Impedance vs. Frequency Measurements

08341-052

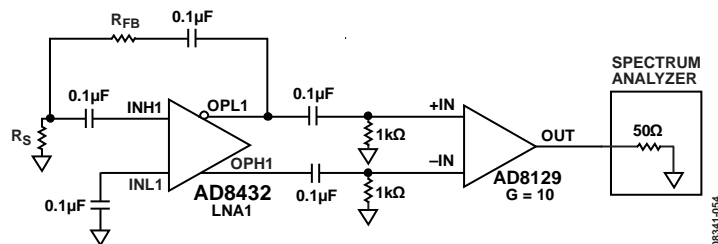

Figure 64. Noise Figure Measurements

08341-054

## THEORY OF OPERATION

### LOW NOISE AMPLIFIER (LNA)

The AD8432 is a dual-channel, ultralow noise amplifier with integrated pin-strappable, gain-setting resistors. The resistors can be externally connected to achieve differential gains of 12.04 dB, 18.06 dB, 21.58 dB, and 24.08 dB ( $\times 4$ ,  $\times 8$ ,  $\times 12$ , and  $\times 16$ , respectively). A simplified schematic of an LNA is shown in Figure 65.

The LNA is driven with a single-ended input and measured differentially at the output. The inverting input INL must be ac-coupled to ground through a capacitor for proper operation. The LNA cannot be driven differentially due to the asymmetry of the internal gain setting resistors. The gain from the inverting input INL to the single-ended output (OPH or OPL) does not match the gain from the noninverting input INH to the single-ended output.

The AD8432 inputs have a dc bias voltage of 3.25 V, which is generated internally. The inputs must be ac-coupled through a series capacitor to maintain the dc bias level of the inputs. Likewise, the AD8432 outputs have a dc bias voltage of 2.5 V. An ac coupling capacitor in series with each single-ended output is recommended to prevent improper loading of the outputs. The AD8432 inputs have a dc bias voltage of 3.25 V, which is generated internally. The inputs must be ac-coupled through a series capacitor to maintain the dc bias level of the inputs (see CINL and CINH in Figure 65).

The AD8432 supports a differential output voltage of 4.8 V p-p for the common-mode output voltage of 2.5 V. Therefore, for a

differential gain of  $G = 12.04$  dB, the maximum input voltage allowed is 1.2 V p-p.

Clamping the inputs ensures quick recovery from large input voltages. The input back-to-back diodes, which are integrated inside the die (IND1 and IND2), should be used for the lowest gain configuration (12.04 dB) to protect the input from overdriving. They should be connected after the source resistance or before the INH coupling capacitor.

The use of a fully differential topology and negative feedback minimizes distortion. A differential signal enables smaller swings at each output, which results in reduction of third-order distortion.

The AD8432 is a voltage feedback amplifier. Due to gain bandwidth product (GBW), a decrease in bandwidth should be expected as the gain increases. Table 5 displays the values of the  $-3$  dB bandwidth for each gain with unterminated input impedance.

### GAIN SETTING TECHNIQUE

Pin strapping is used to set the gain of the amplifier. Gain setting resistors are integrated in the LNA and are accessible externally through the GOH, GMH, GML, and GOL pins. By externally shorting these pins, and thereby shorting or connecting the internal resistors, the AD8432 can be configured for four different gains. Table 5 shows which pins must be connected to achieve the desired gain.

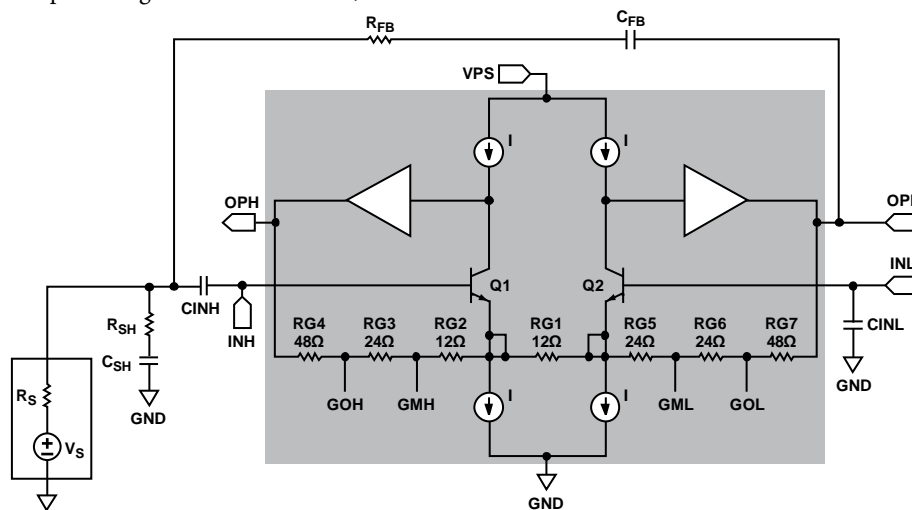

Figure 65. Simplified Schematic of LNA

**Table 5. Gain Setting Using a Pin-Strapping Technique and –3 dB Bandwidth for Each Gain Configuration**

Differential Gain (dB)	Single Gain (dB)	–3 dB BW (MHz)	RG1 (Ω)	RG2 (Ω)	RG3 (Ω)	RG4 (Ω)	RG5 (Ω)	RG6 (Ω)	RG7 (Ω)
12.04	6.02	200	12	12	Connect GMH to GOH	Connect GOH to OPH	24	Connect GML to GOL	Connect GOL to OPL
18.06	12.04	90	12	12	24	Connect GOH to OPH	24	24	Connect GOL to OPL
21.58	15.56	50	12	12	Connect GMH to GOH	48	24	Connect GML to GOL	48
24.08	18.06	32	12	12	24	48	24	24	48

The single-ended gain from INH to OPH (see Figure 65) is defined as

$$G_{OPH-INH} = \frac{R_{G1} + R_{G2} + R_{G3} + R_{G4}}{R_{G1}}$$

The single-ended gain from INH to OPL is defined as

$$G_{OPL-INH} = -\frac{R_{G5} + R_{G6} + R_{G7}}{R_{G1}}$$

The values of the seven gain resistors were chosen so that both single-ended gains are equal. For example, to set a gain of 12.04 dB ( $G = \times 4$ ) differentially, the gain from INH to each output (OPH, OPL) should be 6.02 dB ( $G = \times 2$ ).

INH to OPH: For  $R_{G1} = R_{G2} = R_G$ , then

$$G_{OPH-INH} = \frac{R_{G1} + R_{G2}}{R_{G1}} = \frac{2 \times R_G}{R_G} = 2$$

INH to OPL: For  $R_{G1} = R_G$  and  $R_{G5} = 2 \times R_G$ , then

$$G_{OPL-INH} = -\frac{R_{G5}}{R_{G1}} = -\frac{2 \times R_G}{R_G} = -2$$

### ACTIVE INPUT RESISTANCE MATCHING

The AD8432 reduces noise and optimizes signal power transfer by using active input termination to perform signal source resistance matching.

The primary purpose of input impedance matching is to optimize the input signal power transfer. With resistive termination, the input noise increases due to the thermal noise of the terminating resistor and the increased contribution of the input voltage noise generator of the LNA. With active impedance matching, however, the contributions of both are smaller than they are for resistive termination by a factor of  $1/(1 + \frac{1}{2} \text{ LNA gain})$ . The noise figure (NF) for the three terminating schemes is shown in Figure 67.

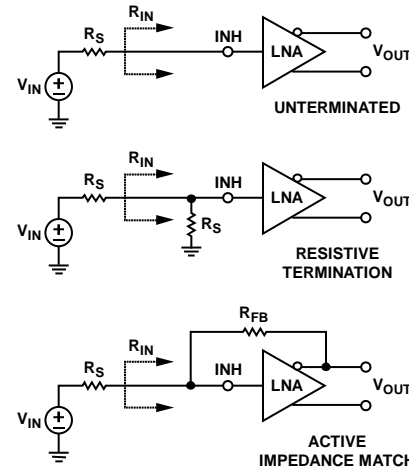

Figure 66. Input Resistance Matching

To achieve this active impedance match, connect a feedback resistor,  $R_{FB}$ , between the INH and OPL (see Figure 66).  $R_{IN}$  is given in Equation 1, where  $G/2$  is the single-ended gain.

$$R_{IN} = \frac{R_{FB}}{1 + \frac{G}{2}} \tag{1}$$

In addition, to further reduce the input resistance, there is an internal resistance of 6.2 kΩ in parallel with the source resistance, such that

$$R_{IN} = \frac{R_{FB}}{1 + \frac{G}{2}} \parallel R_{INTERNAL} \tag{2}$$

Equation 3 should be used to calculate  $R_{FB}$  accurately for a desired input resistance and single-ended gain. Refer to Table 6 for calculated results for  $R_{FB}$  for several input resistance and gain combinations.

$$\Rightarrow R_{FB} = \frac{R_{IN} \left(1 + \frac{G}{2}\right)}{1 - \frac{R_{IN}}{R_{INTERNAL}}}, R_{INTERNAL} = 6.2 \text{ k}\Omega \tag{3}$$

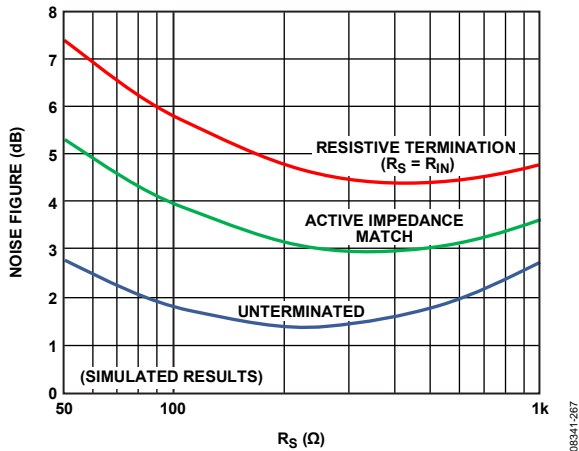

Figure 67. Noise Figure vs.  $R_s$  for Resistive, Active Match, and Terminated Inputs

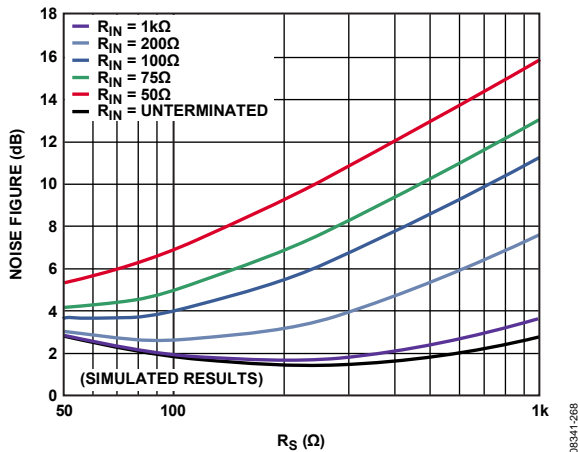

Figure 68. Noise Figure vs.  $R_s$  for Various Values of  $R_{IN}$ , Actively Matched

The user must determine the level of matching accuracy desired and adjust  $R_{FB}$  accordingly. The  $R_{FB}$  and  $C_{FB}$  network presents a load to OPL that OPH does not see. The user can add an identical load on OPH to improve slightly the distortion caused by this imbalance.

There is a feedback capacitor ( $C_{FB}$ ) in series with  $R_{FB}$  (see Figure 65) because the dc levels of the positive output and the positive input are different. At higher frequencies, the value of the feedback capacitor must be considered.

The unterminated bandwidth ( $R_{FB} = \infty$ ) is 200 MHz. The AD8432 has a low input-referred voltage noise of  $0.85 \text{ nV}/\sqrt{\text{Hz}}$  at the lowest gain, 12.04 dB (unterminated configuration). To achieve such low noise, the dual amplifier consumes 24 mA, resulting in a power consumption of 120 mW.

Table 6. Feedback Resistance for Several  $R_{IN}$  and Gain Combinations

Desired $R_{IN}$ ( $\Omega$ )	Differential Gain (V/V)	Single-Ended Gain, $G/2$ (V/V)	Exact $R_{FB}$ ( $\Omega$ ), Equation 2	$R_{FB}$ ( $\Omega$ ), 1% Standard Value	Actual $R_{IN}$ ( $\Omega$ ), Equation 2
50	4	2	151.2	150	49.6
75	4	2	227.8	226	74.4
100	4	2	304.9	301	98.7
200	4	2	620	619	199.7
1 k	4	2	3.58 k	3.57 k	998.4
50	8	4	252	250	49.6
100	8	4	508.2	511	100.5
50	12	6	352.9	357	50.6
100	12	6	711.5	715	100.5
50	16	8	453.7	453	49.9
100	16	8	914.8	909	99.4

## APPLICATIONS INFORMATION

The AD8432 LNA provides precision gain and ultralow noise performance with minimal external components. Because it is a high performance part, care must be taken to ensure that it is configured optimally to attain the best performance and dynamic range for the system.

### TYPICAL SETUP

The internal bias circuitry of the AD8432 sets the input bias voltage at 3.25 V and the output bias voltage at 2.5 V. It is important to ac couple the inputs through a capacitor to maintain the internal dc bias levels. When active input termination is used ( $R_{FB}$ ), a decoupling capacitor ( $C_{FB}$ ) is required to isolate the input and output bias voltages of the LNA. A typical value for  $C_{FB}$  is 0.1  $\mu\text{F}$ , but a smaller value capacitor is more appropriate at higher frequencies.

The unterminated input impedance of the AD8432 is 6.2 k $\Omega$ . Any input resistance between 50  $\Omega$  and 6.2 k $\Omega$  can be synthesized using active impedance matching.

At the lowest gain (12.04 dB), the gain response exhibits some peaking at higher frequencies. A resistor-capacitor shunt network (RC) at the input (see  $R_{SHx}$  and  $C_{SHx}$  in Figure 69) is recommended to reduce gain peaking and enhance stability at higher frequencies.

Table 7 shows the recommended values of  $R_{FB}$ ,  $C_{SH}$ , and  $R_{SH}$  for all four gains and several input impedance combinations. The values for the  $C_{SH}$  and  $R_{SH}$  network are determined empirically and can be customized as needed to optimize performance. As  $R_{IN}$  increases, the value of  $C_{SH}$  diminishes, and for higher input impedance values, no capacitor may be required.

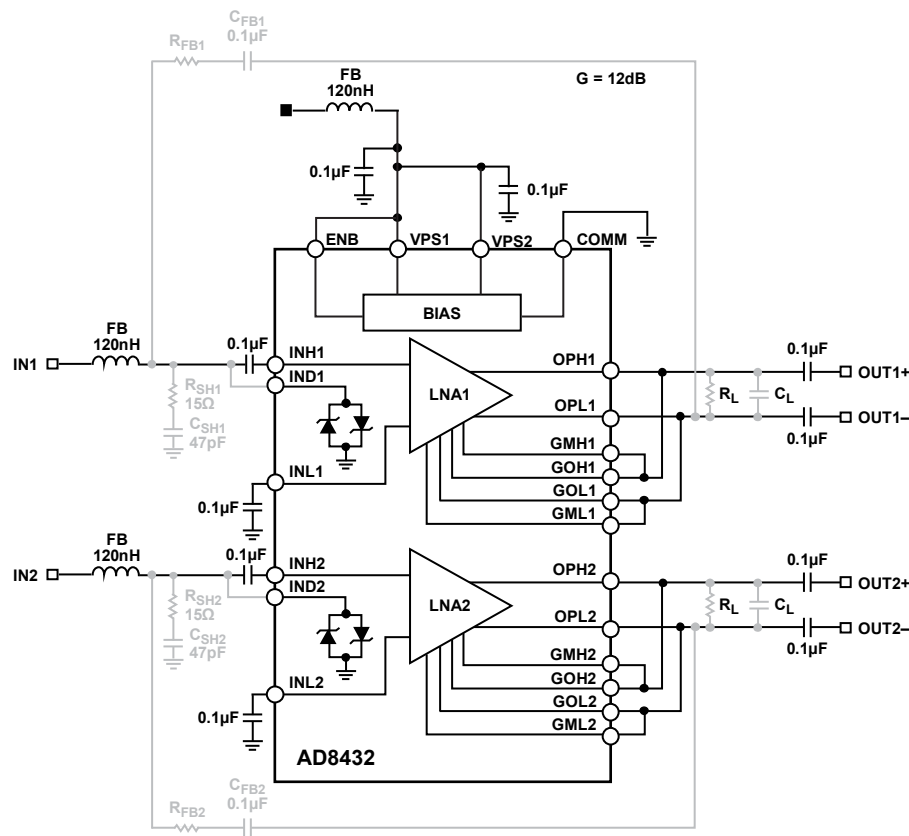

Figure 69. Typical AD8432 Setup,  $G = 12.04 \text{ dB}$

08341-040

# AD8432

Table 7. External Component Selections for Common Input Impedance

$R_{IN}$ ( $\Omega$ )	Gain (dB)	$R_{FB}$ ( $\Omega$ )	$C_{SH}$ (pF)	$R_{SH}$ ( $\Omega$ )	-3 dB BW (MHz)
50	12	150	47	15	176
	18	249	30	15	116
	21	357	None	None	117
	24	453	None	None	87
75	12	226	36	15	167
	18	383	None	None	144
	21	536	None	None	100
	24	681	None	None	72
100	12	301	30	15	164
	18	511	None	None	134
	21	715	None	None	90
	24	909	None	None	63
200	12	619	18	15	164
	18	1.02 k	None	None	116
	21	1.43 k	None	None	74
	24	1.87 k	None	None	51
1 k	12	3.57 k	10	10	160
	18	5.9 k	None	None	99
	21	8.25 k	None	None	61
	24	10.7 k	None	None	43
Unterminated, $R_s = 50 \Omega$	12	$\infty$	None	None	178
	18	$\infty$	None	None	95
	21	$\infty$	None	None	59
	24	$\infty$	None	None	40
Unterminated, $R_s = 0 \Omega$	12	$\infty$	None	None	210
	18	$\infty$	None	None	96
	21	$\infty$	None	None	55
	24	$\infty$	None	None	38

**I/Q DEMODULATION FRONT END**

The AD8432 low noise amplifiers can be used to drive the differential RF inputs of the dual AD8333 or the quad AD8339 I/Q demodulators. The primary application for the AD8339 is phased array beamforming in medical ultrasound, specifically in CW Doppler processing. Other applications include phased array radar and smart antennas for mobile communications.

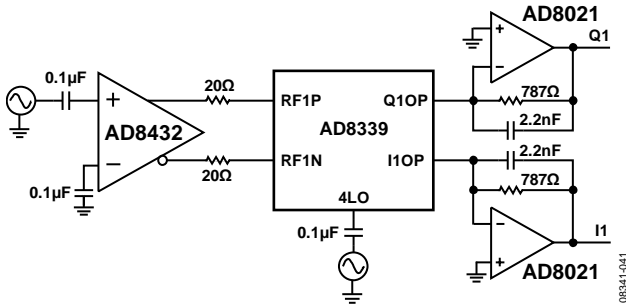

Figure 70. Block Diagram of AD8432 and AD8339 Application for Ultrasound Beamforming

Because of its low output noise and low distortion, the AD8432 ensures minimal degradation in dynamic range while amplifying the RF input signal. At the lowest gain of 12.04 dB, the AD8432 contributes only 3.4 nV/√Hz output voltage noise.

Figure 70 shows a simplified block diagram of one channel of the AD8432 driving the AD8339. The AD8432 outputs can be connected directly to the AD8339 RF inputs through 20 Ω resistors. A differential clock signal, 4LO, which is applied to the

4LOP and 4LON pins of the AD8339, has a frequency 4× that of the RF inputs. The AD8339 downconverts the RF signals, generates quadrature, and phase-shifts the resultant I and Q signals.

The I and Q outputs of the AD8339 are current outputs. A transimpedance amplifier, such as the AD8021, processes the outputs and performs several functions, including the following:

- Current-to-voltage conversion
- Summation amplifier for multiple channels
- Active low-pass filter

In beamforming applications, the I and Q outputs of a number of receiver channels are summed, which increases the system dynamic range by  $10 \log_{10}(N)$ , where N is the number of channels being summed. The external RC feedback network of the AD8021 is a 100 kHz low-pass filter as shown in Figure 70. See the AD8333 and AD8339 datasheets for more details on implementing I/Q demodulators.

Evaluation boards are available for the AD8432 and the AD8339 to facilitate system level design and testing. A detailed reference schematic of the setup is shown in Figure 71. The AD8432 is shown in this configuration with a gain of 12.04 dB, with unterminated inputs. If active termination is preferred, use an  $R_{FB}$  and  $C_{FB}$  network as discussed in the Theory of Operation section. The IND1/IND2 clamping diodes can be connected to IN1/IN2 to protect the LNA input from being overdriven.

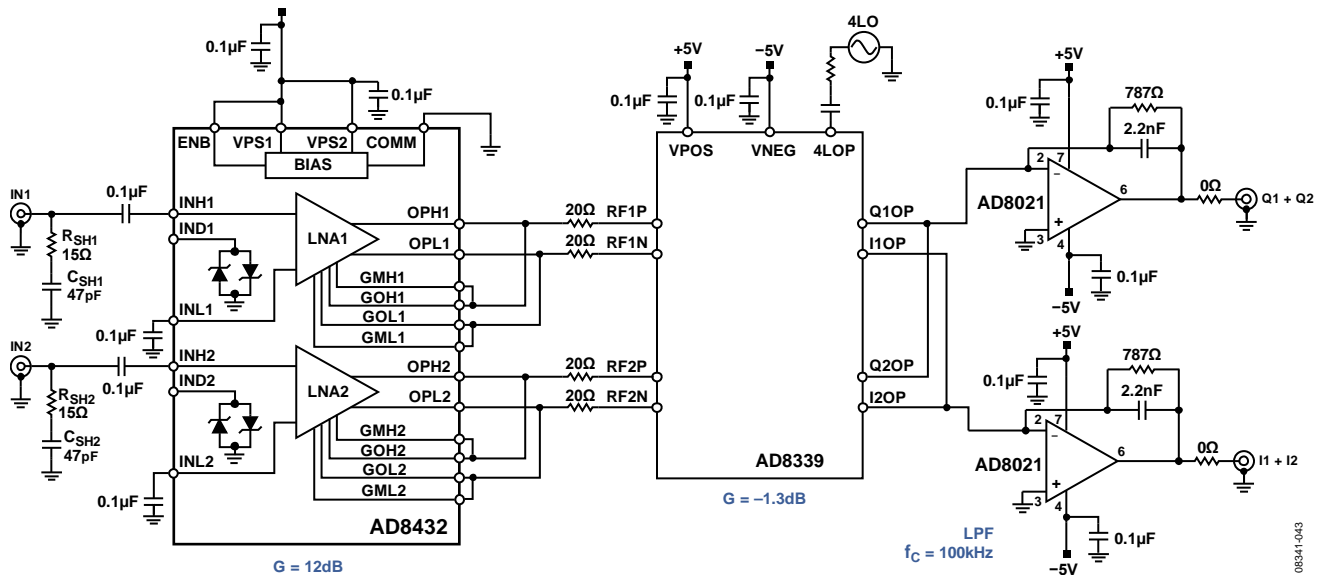

Figure 71. Schematic of the AD8432 (G = 12.04 dB) and AD8339 Application for Ultrasound Beamforming

# AD8432

## DIFFERENTIAL-TO-SINGLE-ENDED CONVERSION

Some applications require the low noise and high dynamic range of the AD8432; however, they may also require a single-ended output, rather than a differential output. The AD8129 or AD8130 differential receiver amplifier can be used for the differential-to-single-ended conversion of the AD8432 output, as shown in Figure 72.

The AD8129 is a low noise, high gain (10 or greater) amplifier intended for applications over very long cables, where signal attenuation is significant. The AD8130 is stable at a gain of 1 and can be used for applications where lower gains are required. The AD8129 and AD8130 have user-adjustable gain, set by the ratio of two resistors, to help compensate for losses in the transmission line.

A transformer or balun can also be used to convert the differential output of the AD8432 to a single-ended output. Transformers have lower distortion; however, care must be taken to properly match the impedance of the transformer. The test circuit for distortion measurements in Figure 58 uses an ADTT1-1 transformer to perform differential-to-single-ended conversion.

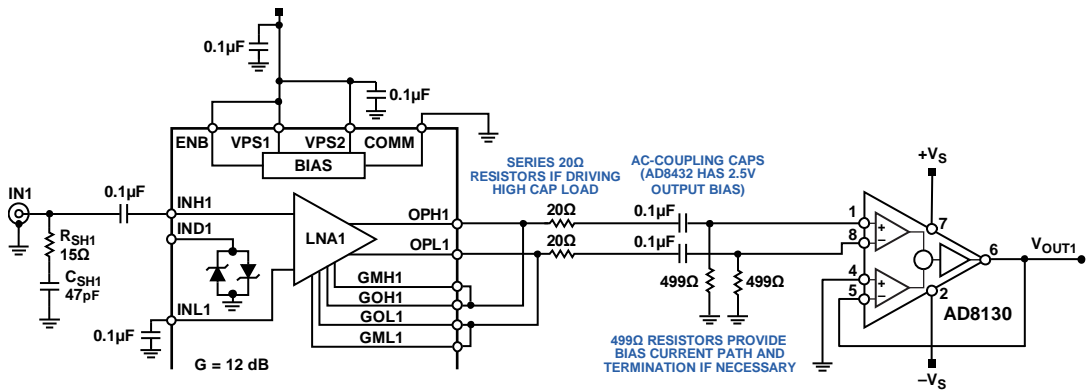



## EVALUATION BOARD

Figure 73 shows the AD8432 evaluation board, and the schematic diagram is shown in Figure 74. Using the board is a convenient and fast way to verify system design and assess the performance of the AD8432 under user-specific operating conditions. The board provides access to all LNA inputs, outputs, and gain setting pins. The board is shipped in a typical  $G = 12.04$  dB configuration but is designed to allow customization of the setup as required.

The AD8432-EVALZ requires a single 5 V power supply. An on-board switch (S1) allows VPS to drive the enable (ENB) input.

### GAIN SETTING

Headers (W5 to W12) are provided across the gain setting pins and can be shorted using jumpers to allow gain setting quickly and easily. Alternately, it is recommended to short the gain setting pins using surface-mount (0402),  $0\ \Omega$  resistors (R1 to R4, R9 to R12) that eliminate the small parasitic capacitances from longer trace lengths to the headers. As shipped, the evaluation board is configured for  $G = 12.04$  dB with these  $0\ \Omega$  resistors.

Table 8 outlines the resistors or headers that must be installed or shorted for each gain configuration.

**Table 8. Gain Setting Using Resistors or Headers**

LNA1		LNA2		Gain (V/V)			
				4	8	12	16
R1	W5	R9	W9	X <sup>1</sup>	X <sup>1</sup>		
R2	W6	R10	W10	X <sup>1</sup>		X <sup>1</sup>	
R3	W7	R11	W11	X <sup>1</sup>		X <sup>1</sup>	
R4	W8	R12	W12	X <sup>1</sup>	X <sup>1</sup>		

<sup>1</sup> X = shorting the indicated header or resistor.

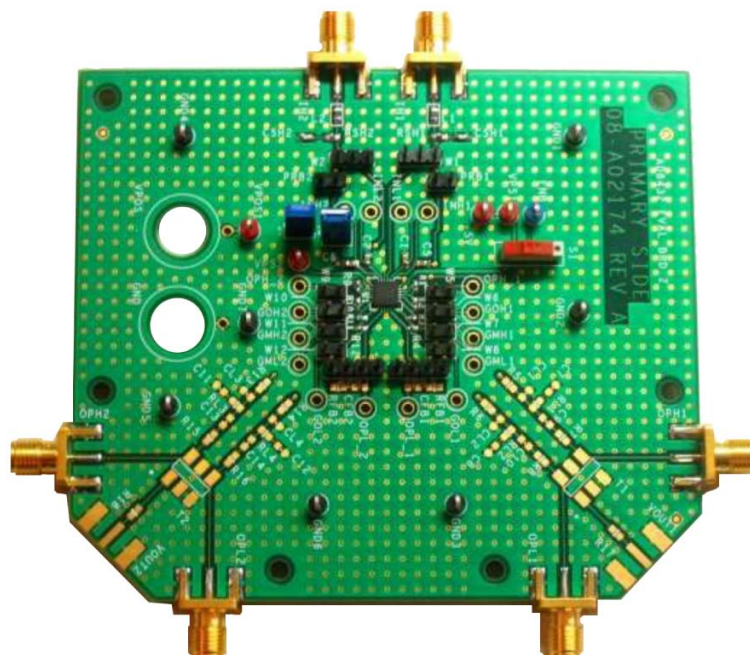

Figure 73. Evaluation Board

08341-045

# AD8432

## SCHEMATIC

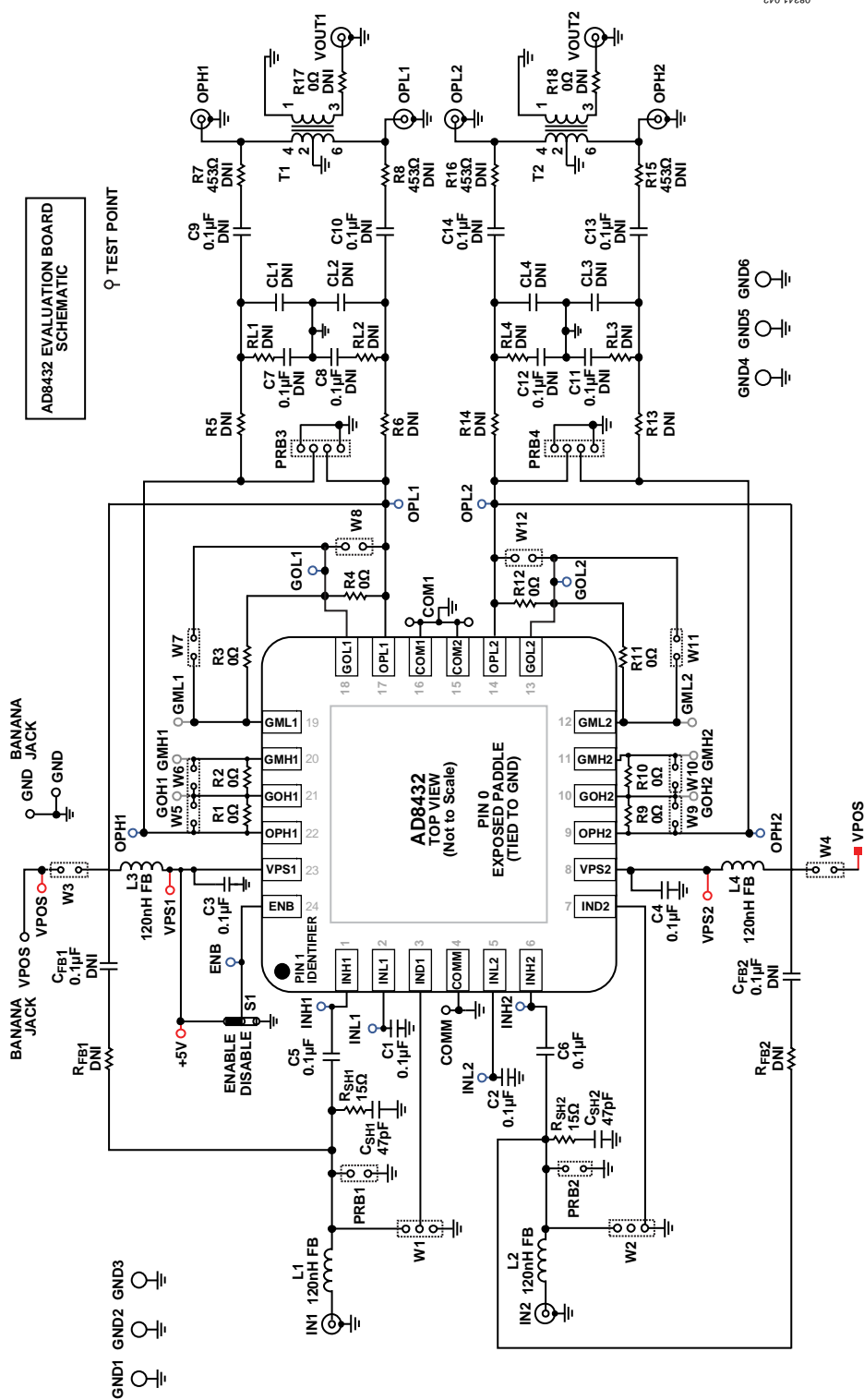

Figure 74. Schematic

## POWER SUPPLY

The AD8432 should be powered by a single 5 V supply connected to the VPOS terminal. Separate supplies can be used for VPS1, VPS2, and ENB, or they can all be tied to VPOS by shorting the W3 and W4 headers and the S1 switch. Ferrite beads and decoupling capacitors are installed for isolation, protection, and power supply noise reduction.

## INPUT TERMINATION

Active input impedance matching can be realized by installing a feedback resistor ( $R_{FB}$ ), the value of which is determined by the gain and source impedance, as described in the Theory of Operation section.  $C_{FB}$  provides the necessary ac coupling between the input and output when using active termination; a 0.1  $\mu$ F capacitor value is recommended. The  $R_{FB}$  and  $C_{FB}$  network presents a load to OPL, and an equivalent load at OPH can be used to balance the differential output.

Input clamping diodes (IND1 and IND2) can be connected to the inputs by shorting the connection on the W1 and W2 headers. The diodes provide overvoltage protection to the input and enable faster overdrive recovery times, especially at the lowest gain (12.04 dB).

## OUTPUT

The AD8432 evaluation board provides the space to configure the output loading conditions required by the user, by populating the given footprints (for example, RL1, RL2, C7, and C8). SMA connectors are available at the outputs, and space for a transformer is also available for differential-to-single-ended conversion.

The 4-pin headers, PRB3 and PRB4, are placed close to the AD8432, and they provide a way for monitoring the differential output or the single-ended output using a high impedance differential probe. The two inner pins of the headers are connected to OPL/OPH, and the two outer pins of the headers are connected to ground.

There are several footprints provided to install ac coupling capacitors at the outputs (C7 to C14). The AD8432 outputs are biased internally at 2.5 V. To maintain the dc bias level, use coupling capacitors between the outputs and the load.

OUTLINE DIMENSIONS

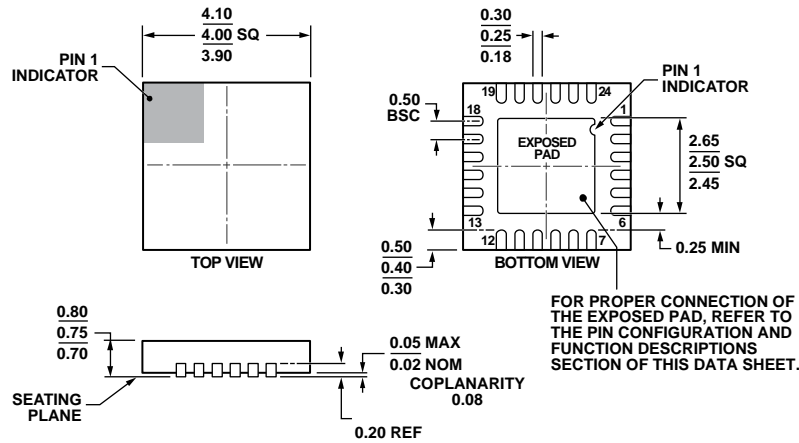

COMPLIANT TO JEDEC STANDARDS MO-220-WGGD.

Figure 75. 24-Lead Lead Frame Chip Scale Package [LFCSP\_WQ]  
 4 mm × 4 mm, Very Very Thin Quad  
 (CP-24-7)  
 Dimensions shown in millimeters

112108-A

ORDERING GUIDE

Model <sup>1</sup>	Temperature Range	Package Description	Package Option
AD8432ACPZ-R7	-40°C to +85°C	24-Lead LFCSP_WQ, 7" Tape and Reel	CP-24-7
AD8432ACPZ-RL	-40°C to +85°C	24-Lead LFCSP_WQ, 13" Tape and Reel	CP-24-7
AD8432ACPZ-WP	-40°C to +85°C	24-Lead LFCSP_WQ, Waffle Pack	CP-24-7
AD8432-EVALZ		Evaluation Board	

<sup>1</sup> Z = RoHS Compliant Part.