

**Description**

The compact DFA20 Series provides power densities up to 11 watts per cubic inch (0.67 watts per cm<sup>3</sup>). Ideal for battery-operated, industrial, medical control, and remote data collection systems, this converter has fully-filtered inputs and outputs. Complete overload protection with independent pulse-by-pulse current limiting and an overtemperature shutdown ensures reliable system operation. The output of the converter is electrically isolated, thereby allowing the output to be configured as a positive or negative output voltage.

**Features**

- RoHS lead solder exemption compliant
- Remote On/Off and trim
- Overcurrent protection and thermal shutdown
- Efficiencies to 83%
- 700V isolation; up to 1544V on 48V converters
- Power density up to 11 Watts per cubic inch
- Five-sided, shielded case



Model Selection				
Model	Input VDC		Output VDC	Output mA
	Min	Max		
DFA20E12S3.3	9	18	3.3	4000
DFA20E12S5	9	18	5	4000
DFA20E12S12	9	18	12	1700
DFA20E12S15	9	18	15	1400
DFA20E24S3.3	18	36	3.3	4000
DFA20E24S5	18	36	5	4000
DFA20E24S12	18	36	12	1700
DFA20E24S15	18	36	15	1400
DFA20E48S12	36	72	12	1700

Model numbers highlighted in yellow or shaded are not recommended for new designs.

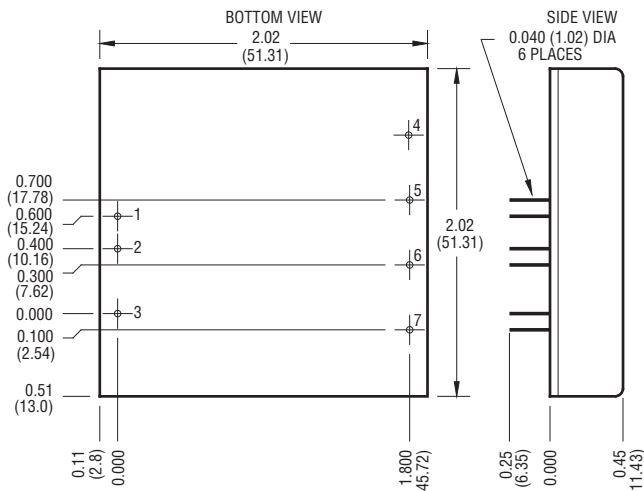

Mechanical tolerances unless otherwise noted:  
X.XX dimensions: ±0.020 inches  
X.XXX dimensions: ±0.005 inches

Pin	Function
1	+Input
2	-Input
3	On/Off
4	No Pin
5	+Out
6	-Out
7	Trim

**NOTES:**

- (1) All parameters measured at Tc = 25°C, nominal input voltage and full-rated load unless otherwise noted.
- (2) The Case is tied to the -Input, Pin 2.
- (3) The functional temperature range is intended to give an additional data point for use in evaluating this power supply. At the low functional temperature the power supply will function with no side effects. However, sustained operation at the high functional temperature will reduce expected operational life. The data sheet specifications are not guaranteed beyond the case operating range.
- (4) The case thermal impedance is specified as the case temperature rise over ambient per package watt dissipated.

General Specifications (1)			
All Models			Units
ON/OFF Function			
ON Logic Level or Pin Open	MIN	> 1.6	VDC
OFF Logic Level or Tie Pin to -Input	MAX	< 0.7	VDC
Open Circuit Voltage	TYP	2.5	VDC
Input Resistance	TYP	20	kOhms
Converter Idle Current ON/OFF Pin Low			
12V Models	TYP	3	mA
24V and 48V Models	TYP	5	mA
Isolation (2)			
Isolation Voltage			
Input to Output 12V, 24V	MIN	700	VDC
Input to Output 48V	MIN	1544	VDC
10µA Leakage			
Input-to-Output Capacitance	TYP	290	pF
Output Trim Function			
Trim Range	MIN	±5	%
Input Resistance	MIN	10	kOhms
Open Circuit Voltage	TYP	2.5	VDC
Environmental			
Case Operating Range, Tc No Derating	MIN	-40	°C
	MAX	85	°C
Case Functional Range (3)	MIN	-50	°C
	MAX	100	°C
Storage Range	MIN	-55	°C
	MAX	105	°C
Thermal Shutdown Case Temperature	TYP	105	°C
Thermal Impedance (4)	TYP	9.5	°C/Watt
General			
MTBF (Calculated)	TYP	800,000	Hrs
Unit Weight	TYP	2.3 / 65	oz / gm
Chassis Mounting Kit 12V, 24V		CM2B 1	
48V		CM2A 1	

Input Parameters (1)								
Model		DFA20E12S3.3	DFA20E12S5	DFA20E12S12	DFA20E12S15	DFA20E24S3.3	DFA20E24S5	Units
Voltage Range	MIN	9				18		VDC
	MAX	18				36		
Reflected Ripple (2)	TYP	350				140		mApp
	TYP	100				40		
Input Current Full Load	TYP	1.46	2.12	2.15	2.21	0.70	1.01	A
	No Load	16	16	16	16	10	10	
Efficiency	TYP	76	79	79	79	80	83	%
Switching Frequency	TYP	220						kHz
Maximum Input Overvoltage, 100ms Maximum	MAX	24				45		VDC
Turn-ON Time, 1% Output Error	TYP	10						ms
Model		DFA20E24S12	DFA20E24S15	DFA20E48S12			Units	
Voltage Range	MIN	18	36			VDC		
	MAX	36	72					
Reflected Ripple (2)	TYP	140	90			mApp		
	TYP	40	25			mArms		
Input Current Full Load	TYP	10	10	8			MA	
	No Load	1.00	1.02	0.51				
Efficiency	TYP	85	86	84			%	
Switching Frequency	TYP	220						kHz
Maximum Input Overvoltage, 100ms Maximum	MAX	45	85			VDC		
Turn-ON Time, 1% Output Error	TYP	10						ms

Output Parameters (1)						
Model		DFA20E12S3.3 DFA20E24S3.3	DFA20E12S5 DFA20E24S5	DFA20E12S12 DFA20E24S12 DFA20E48S12	DFA20E12S15 DFA20E24S15	Units
Output Voltage		3.33	5	12	15	VDC
Output Voltage Accuracy	MIN	3.30	4.95	11.90	14.90	VDC
	TYP	3.33	5.00	12.00	15.00	
	MAX	3.36	5.05	12.10	15.10	
Rated Load Range	MIN	0.0	0.0	0.0	0.0	A
	MAX	4.0	4.0	1.7	1.4	
Load Regulation 25% Max-Max Load	TYP MAX	1				%
Line Regulation Vin = Min-Max VDC	TYP	0.5	0.01			%
	MAX	1.0	0.1			
Short Term Stability (3)	TYP	< 0.05				%/24Hrs
Input Ripple Rejection (4)	TYP	> 40				dB
Noise, 0-20 MHz BW (2)	TYP	75				MVpp
RMS Noise, 0.01 - 1 MHz	TYP	15				mVrms
Temperature Coefficient	TYP	50				ppm/°C
	MAX	150				
Short Circuit Protection to Common for all Outputs	Continuous, with Thermal Protection					

#### NOTES:

- (1) All parameters measured at Tc = 25°C, nominal input voltage and full-rated load unless otherwise noted.
- (2) Noise measurement bandwidth is 0-20 MHz for peak-to-peak measurements; 10 kHz to 1 MHz for RMS measurements. Output noise is measured with a 0.01µF ceramic capacitor in parallel with a 1µF, 35V Tantalum capacitor located 1" away from the converter to simulate your PCB's standard decoupling. Input reflected ripple is measured into a 10µH source impedance.
- (3) Short-term stability is specified after a 30-minute warmup at full load, constant line and recording the drift over a 24-hour period.
- (4) The input ripple rejection is specified for DC to 120 Hz ripple with a modulation amplitude of 1% of Vin.

**DFA20 SERIES APPLICATION NOTES:**

**External Capacitance Requirements**

No external capacitance is required for operation of the DFA20 Series. The use of input capacitors with less than 0.5 Ohms ESR may cause peaking in the input filter and degrade filter performance. External output capacitance is not required for operation. However, it is recommended that 1 $\mu$ F to 10 $\mu$ F of tantalum and 0.001 to 0.1 $\mu$ F ceramic capacitance be selected for reduced system noise. Additional output capacitance may be added for increased filtering, but should not exceed 400 $\mu$ F.

**Negative Outputs**

A negative output voltage may be obtained by connecting the +OUT to circuit ground and connecting -OUT as the negative output.

**Remote ON/OFF Operation**

The remote ON/OFF pin may be left floating if this function is not used. It is recommended to drive this pin with an open collector arrangement or a relay contact.

When the ON/OFF pin is pulled low with respect to the -INPUT, the converter is placed in a low power drain state.

**Output Trim**

The TRIM pin may be used to adjust the output  $\pm$ 5% from the nominal setting. This function allows adjustment for voltage drops in the system wiring, as well as the 5.2 volt outputs for ECL applications. Figure 1 shows the proper connections to use this function. A trimpot value of 10 kOhms should be used for 3.3 and 5 volt outputs. A trimpot value of 20 kOhms should be used for 12 and 15 volt outputs. If the TRIM function is not required, the pin may be left floating.

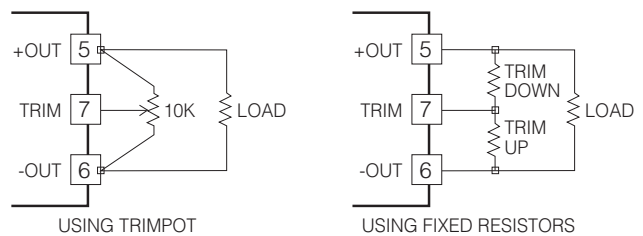

**Figure 1.**

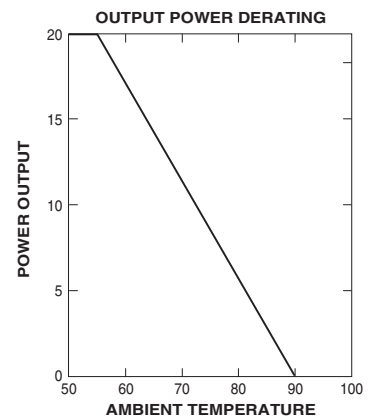
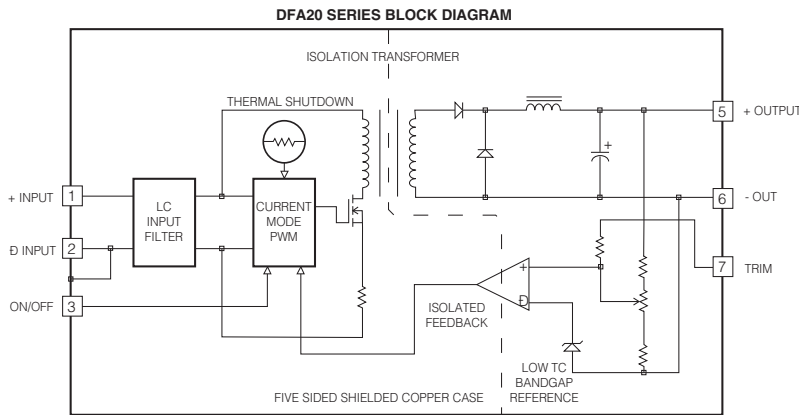

Typical Performance: (Tc=25°C, Vin=Nom VDC, Rated Load)

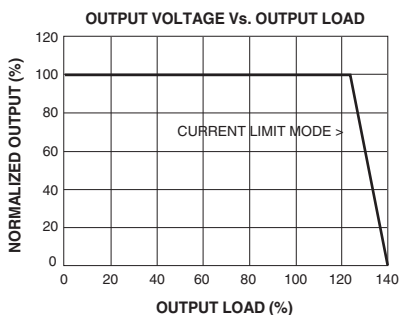
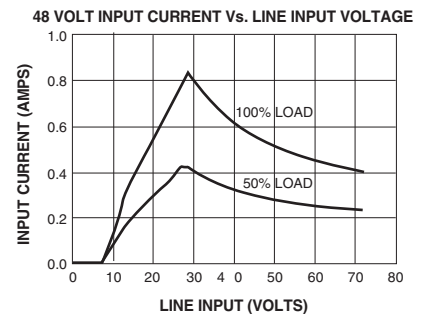
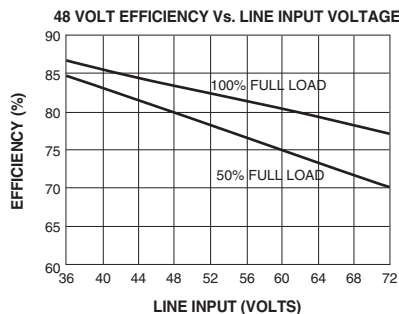
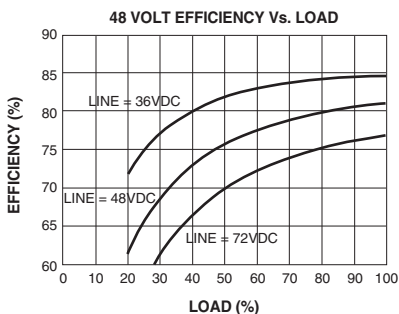
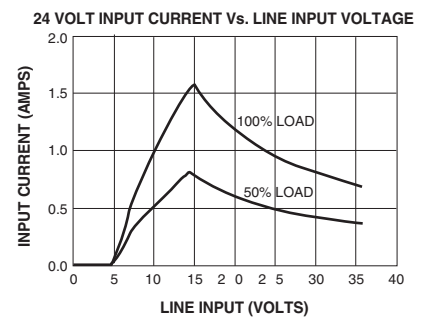
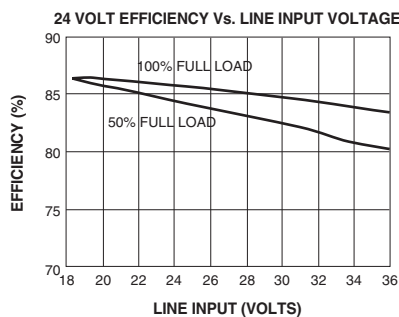
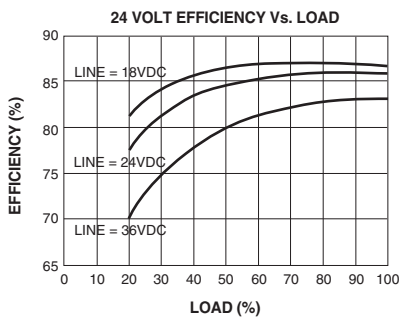
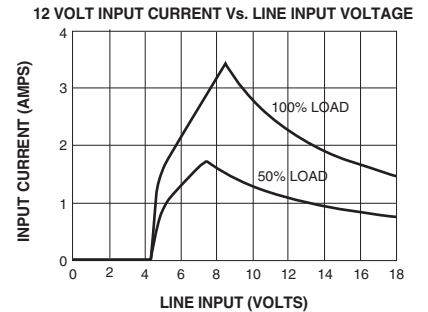
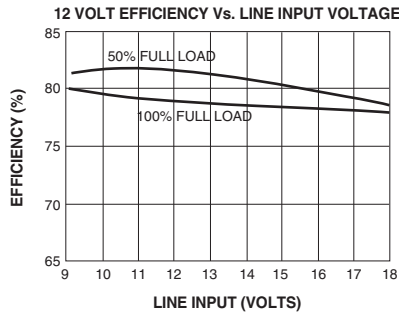
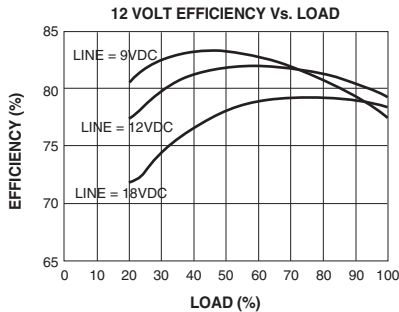

**NOTES ON USING THE CURVES**

- 1) The input currents are for 20 watts of output power. For  $\pm 5$  volt output models the current is approximately 15% less.
- 2) The efficiency curves are for 12 volt output models. To use for other models, adjust as follows:  
 $\pm 5$  volt models subtract approximately 3%.  
 $\pm 15$  volt models add approximately 1%.

**NUCLEAR AND MEDICAL APPLICATIONS** - Power-One products are not designed, intended for use in, or authorized for use as critical components in life support systems, equipment used in hazardous environments, or nuclear control systems without the express written consent of the respective divisional president of Power-One, Inc.

**TECHNICAL REVISIONS** - The appearance of products, including safety agency certifications pictured on labels, may change depending on the date manufactured. Specifications are subject to change without notice.