



FEATURES

- Small size, 1" x 1" x 0.45"
- Full 5 Watts output power
- No external components required
- Drop-in replacements for many standard, 2" x 1" DC/DCs
- Wide input voltage ranges:
18-36V or 36-72V
- 5, 12, or 15V outputs
- Guaranteed efficiencies to 80%
- Fully regulated and isolated
(1000Vdc guaranteed)
- Output overvoltage protection and current limiting
- -25 to +95°C operating temperature
- Shielded cases (5 sides)
- UL 1950, CSA 22.2 No. 234, IEC 950
- Modifications and customs for OEM's

PRODUCT OVERVIEW

The migration to distributed power is accelerating. The critical need for accurate voltages, tight regulation and rapid transient response is propelling the move to power processing at the "point-of-use" with low-power DC/DC converters physically located right at their loads.

DATEL's miniature, full featured, 5 Watt UWR Models were specifically designed for today's demanding distributed power architectures in aerospace, marine, telecom and computer applications. The converters' low cost, small size (1" x 1" x 0.45") and full 5 Watt output capability give system architects unprecedented design and layout flexibility.

Occupying less than 0.5in³ total volume, these extremely compact, fully regulated and isolated (1000Vdc guaranteed) modules are available with either 5, 12 or 15 Volt outputs. Input voltage ranges are either 18-36 Volts ("D24" models) or 36-72 Volts ("D48" models).

Although their overall size is 50-75% smaller than many similarly rated power modules, these 1" x 1" UWR Models are exact, drop-in, pin-for-pin replacements for many standard 2" x 1" and 2" x 2", 5 Watt modules. They achieve their small size and low cost by exploiting a novel feedback approach that does not depend upon traditional optocoupler techniques.

All models are 5-side shielded and have a non-conductive baseplate that permits pc-card runs to be placed beneath the package. Units are assembled using high-speed automated SMT techniques and are fully encapsulated with thermally conductive potting compound. Every unit is electrically tested before and after encapsulation, 100% burned-in under full load, hi-pot tested, and final-electrical tested prior to shipment. Every unit meets DATEL's traditional high standards for quality and long-term reliability.

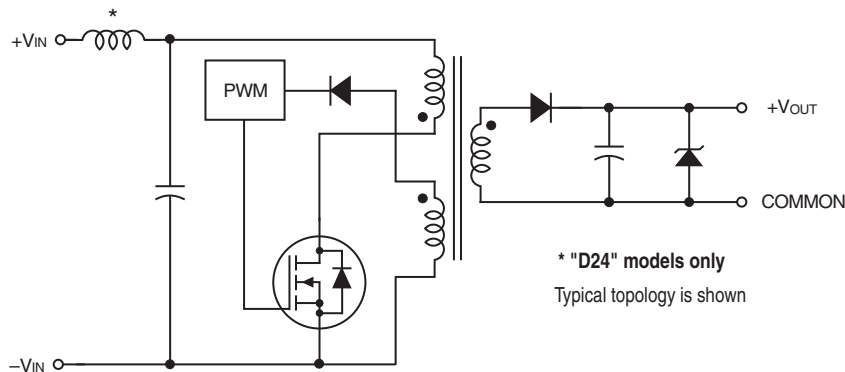

Figure 1. Simplified Block Diagram



Performance Specifications and Ordering Guide ^①

ORDERING GUIDE										
Model	Output					Input			Efficiency (Min.)	Package (Case, Pinout)
	Vout (Volts)	Iout (mA, max)	Ripple/Noise ^② (mVp-p, Max.)	Regulation (Max.)		Vin Nom. (Volts)	Range (Volts)	Iin ^④ (mA, Max.)		
				Line	Load ^③					
UWR-5/1000-D24	5	1000	120	±2%	±2%	24	18-36	25/282	75%	C7, P3
UWR-5/1000-D48	5	1000	120	±2%	±2%	48	36-72	25/141	75%	C7, P3
UWR-12/420-D24	12	420	150	±2%	±2%	24	18-36	25/265	80%	C7, P3
UWR-12/420-D48	12	420	150	±2%	±2%	48	36-72	25/133	80%	C7, P3
UWR-15/335-D24	15	335	150	±2%	±2%	24	18-36	25/264	80%	C7, P3
UWR-15/335-D48	15	335	150	±2%	±2%	48	36-72	25/132	80%	C7, P3

① Typical at TA = +25°C under nominal line voltage and full-load conditions unless otherwise noted.
 ② Ripple/Noise (R/N) measured over a 20MHz bandwidth.
 ③ 20% to 100% load.

④ Nominal line voltage, no-load/full-load conditions.
 ⑤ RoHS-6 hazardous substance compliance does not claim EU exemption 7b (lead in solder).

PART NUMBER STRUCTURE

U **WR** - **15** / **335** - **D24** - **C**

Output Configuration:
U = Unipolar

Wide Range Input

Nominal Output Voltage
 5, 12 or 15 Volts

RoHS-6 hazardous substance compliant*

Input Voltage Range:
D24 = 18-36 Volts (24V nominal)
D48 = 36-72 Volts (48V nominal)

Maximum Output Current in mA

* Contact Murata Power Solutions (Datel) for availability.

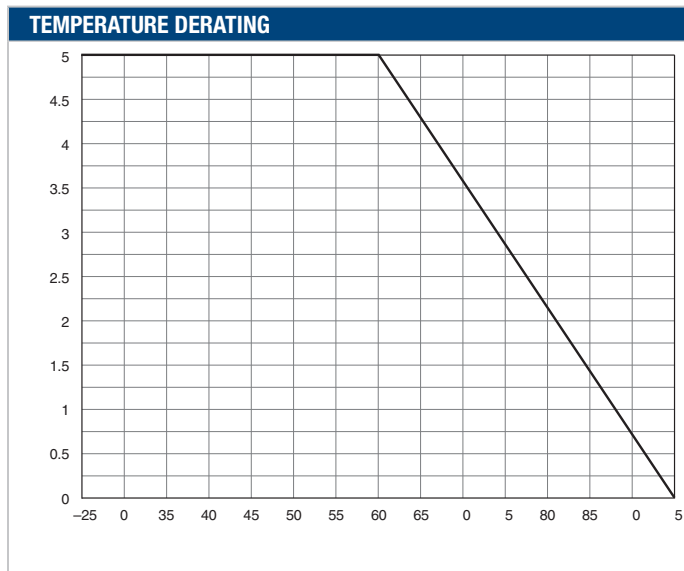

MECHANICAL SPECIFICATIONS

Notes:

For "D24" models, the case is connected to pin 2 (-VIN).

For "D48" models, the case is connected to pin 1 (+VIN).

INPUT/OUTPUT CONNECTIONS	
Pin	Function P3
1	+Input
2	-Input
3	+Output
4	No Pin
5	No Pin
6	Common

Dimensions are in inches (mm shown for ref. only).

Tolerances (unless otherwise specified):
 .XX ± 0.02 (0.5)
 .XXX ± 0.010 (0.25)
 Angles ± 2°
 Components are shown for reference only.

Performance/Functional Specifications

Typical @ TA = +25°C under nominal line voltage and full-load conditions, unless noted. ①

INPUT	
Input Voltage Range:	
"D24" Models	18-36 Volts (24V nominal)
"D48" Models	36-72 Volts (48V nominal)
Input Current	See Ordering Guide
Input Filter Type ②	LC on "D24" models C on "D48" models
Reverse-Polarity Protection	Yes (Instantaneous, 6A maximum)
OUTPUT	
V_{out} Accuracy (50% load):	
5V Outputs	±1.5%, maximum
12/15V Outputs	±1%, maximum
Temperature Coefficient	±0.02% per °C
Ripple/Noise (20MHz BW) ②	See Ordering Guide
Line Regulation	See Ordering Guide
Load Regulation	See Ordering Guide
Efficiency	See Ordering Guide
Isolation Voltage ③	1000Vdc, minimum
Current Limiting	Auto-recovery
Overvoltage Protection	Zener/transorb clamp
DYNAMIC CHARACTERISTICS	
Transient Response (50% load step)	500µsec max. to ±2% of final value
Switching Frequency	170kHz (±10kHz)
ENVIRONMENTAL	
Operating Temperature (Ambient): ④	
Without Derating	-25 to +60°C
With Derating	to +95°C (See Derating Curve)
Storage Temperature	-55 to +125°C
Flammability	UL94V-0
PHYSICAL	
Dimensions	1" x 1" x 0.45" (25.4 x 25.4 x 11.4mm)
Shielding	5-sided
Case Connection:	
"D24" Models	Pin 2 (-V _{IN})
"D48" Models	Pin 1 (+V _{IN})
Case Material	Corrosion resistant steel with non-conductive, powder coat matte black finish and plastic baseplate
Pin Material	Gold plate over copper alloy
Weight	0.7 ounces (20 grams)

① These power converters require a minimum 20% loading to maintain specified regulation. Operation under no-load conditions will not damage these devices; however they may not meet all listed specifications.

ABSOLUTE MAXIMUM RATINGS

Input Voltage:	
"D24" Models	40 Volts
"D48" Models	80 Volts
Input Reverse-Polarity Protection	Current must be < 6A. Brief duration only. Fusing recommended.
Output Overvoltage Protection:	
5V Outputs	6.8 Volts, limited duration
12V Outputs	15 Volts, limited duration
15V Outputs	18 Volts, limited duration
Output Current	Current limited. Max. current and short-circuit duration are model dependent.
Storage Temperature	-55 to +125°C
Lead Temperature (soldering, 10 sec.)	+300°C

These are stress ratings. Exposure of devices to greater than any of these conditions may adversely affect long-term reliability. Proper operation under conditions other than those listed in the Performance/Functional Specifications Table is not implied.

TECHNICAL NOTES

Floating Outputs

Since these are isolated DC/DC converters, their outputs are "floating." Users may ground either the Common (pin 6) for normal usage or the positive side (+Output, pin 3) to effectively reverse the output polarity.

Filtering and Noise Reduction

All UWR 5 Watt DC/DC Converters achieve their rated ripple and noise specifications without the use of external input/output capacitors. In critical applications, input/output ripple and noise may be further reduced by installing low-ESR, tantalum or electrolytic capacitors across the input and/or output terminals. The capacitors should be located as close to the power converters as possible. Typical values are listed below. In many applications, using values greater than those listed will yield better results.

To Reduce Input Ripple

"D24" Models	20µF, 50V
"D48" Models	10µF, 100V

To Reduce Output Ripple

5V Outputs	47µF, 10V, Low ESR
12/15V Outputs	33µF, 20V, Low ESR

Input Fusing

Certain applications and/or safety agencies may require the installation of fuses at the inputs of power conversion components. For DATEL UWR 5 Watt DC/DC Converters, you should use fast-blow type fuses with values no greater than 0.5A.

TYPICAL PERFORMANCE CURVES (T_A = +25°C)

The performance curves below were derived from actual test data for a single model number (UWR-5/1000-D24). Since all devices in this Series have the same circuit topology, the performance curves are representative of all devices.

EFFICIENCY VS. INPUT VOLTAGE AND OUTPUT LOAD

Efficiency vs. Input Voltage

(Full-load conditions. Guaranteed efficiency = 75% at V_{IN} = 24V)

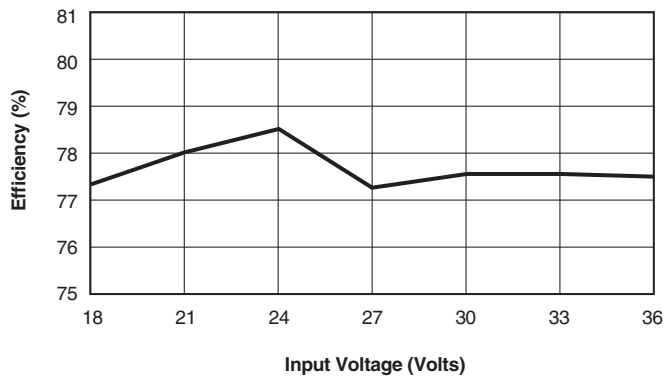

Efficiency vs. Output Load

(V_{IN} = nominal = 24V. Guaranteed efficiency at full load = 75%)

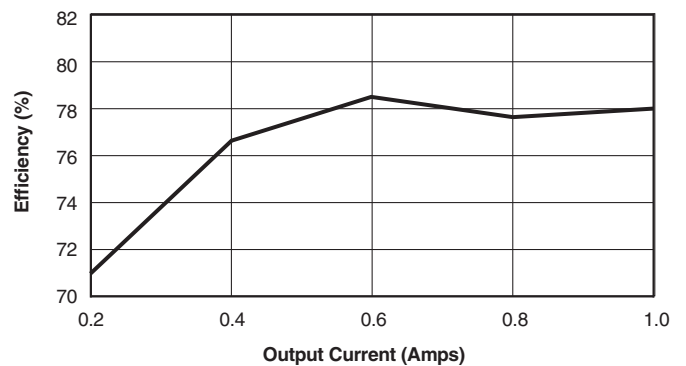

LINE REGULATION

Output Voltage vs. Input Voltage

(Full-load conditions. Nominal V_{OUT} = 5V)

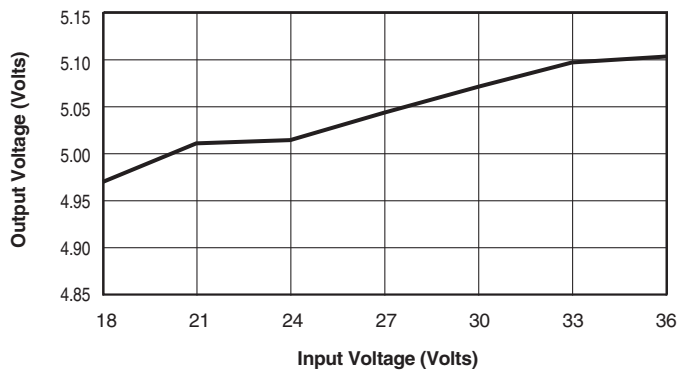

LOAD REGULATION

Output Voltage vs. Output Load

(V_{IN} = nominal = 24V. Nominal V_{OUT} = 5V)

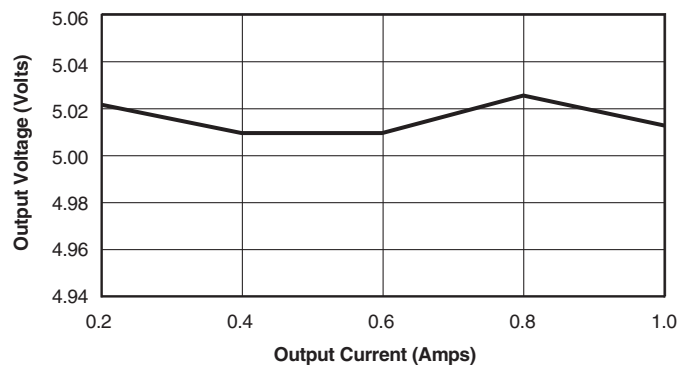

CUSTOM CAPABILITIES

DATEL's world-class design, development and manufacturing team stands ready to work with you to deliver the exact power converter you need for your demanding, large volume, OEM applications. And ... we'll do it on time and within budget!

Our experienced applications and design staffs; quick-turn prototype capability; highly automated, SMT assembly facilities; and in-line SPC quality-control techniques combine to give us the unique ability to design and deliver any quantity of power converters to the highest standards of quality and reliability.

We have compiled a large library of DC/DC designs that are currently used in a variety of telecom, medical, computer, railway, aerospace and industrial applications. We may already have the converter you need.

Contact us. Our goal is to provide you the highest-quality, most cost-effective power converters available.

EMI RADIATED EMISSIONS

If you're designing with EMC in mind, please note that all of DATEL's UWR 5 Watt DC/DC Converters have been characterized for radiated and conducted emissions in our new EMI/EMC laboratory. Testing is conducted in an EMCO 5305 GTEM test cell utilizing EMCO automated EMC test software. Radiated emissions are tested to the limits of FCC Part 15, Class B and CISPR 22 (EN 55022), Class B. Correlation to other specifications can be supplied upon request. Radiated emissions plots to FCC and CISPR 22 for model UWR-5/1000-D24 appear below. Its performance is typical of all models in the Family.

UWR-5/1000-D24 Radiated Emissions
FCC Part 15 Class B, 3 Meters
Converter Output = 5Vdc @ 800mA

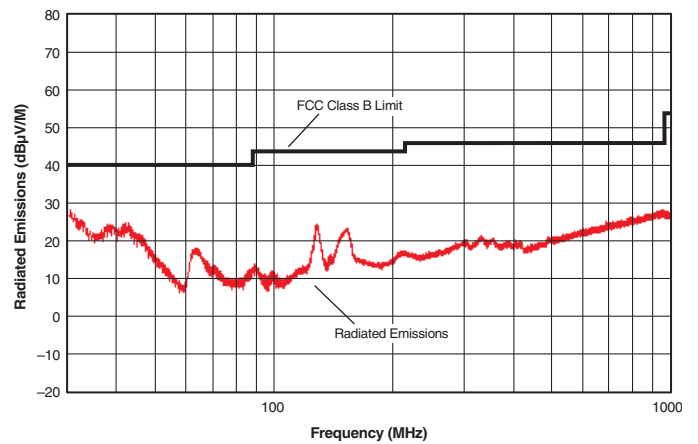

UWR-5/1000-D24 Radiated Emissions
EN 55022 Class B, 10 Meters
Converter Output = 5Vdc @ 800mA

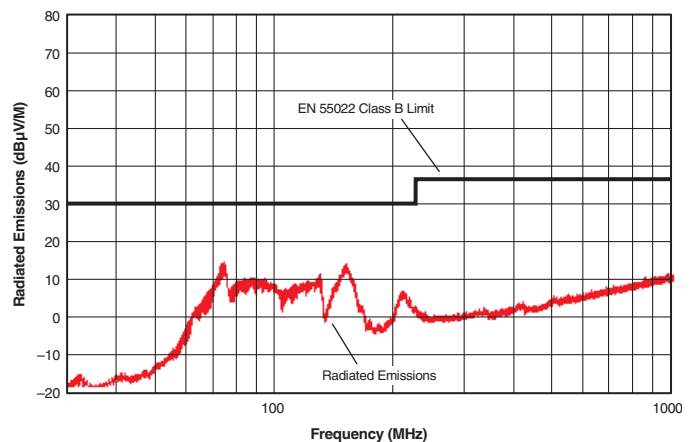

Murata Power Solutions, Inc.
 11 Cabot Boulevard, Mansfield, MA 02048-1151 U.S.A.
 ISO 9001 and 14001 REGISTERED

Murata Power Solutions, Inc. makes no representation that the use of its products in the circuits described herein, or the use of other technical information contained herein, will not infringe upon existing or future patent rights. The descriptions contained herein do not imply the granting of licenses to make, use, or sell equipment constructed in accordance therewith. Specifications are subject to change without notice. © 2010 Murata Power Solutions, Inc.

