

LP38511-1.8

800 mA Fast-Transient Response Low-Dropout Linear Voltage Regulator with Error Flag

General Description

The LP38511-1.8 Fast-Transient Response Low-Dropout Voltage Regulator offers the highest-performance in meeting AC and DC accuracy requirements for powering Digital Cores. The LP38511-1.8 uses a proprietary control loop that enables extremely fast response to change in line conditions and load demands. Output Voltage DC accuracy is guaranteed at $\pm 2.5\%$ over line, load and full temperature range from -40°C to $+125^{\circ}\text{C}$. The LP38511-1.8 is designed for inputs from the 2.5V, 3.3V, and 5.0V rail, is stable with 10 μF ceramic capacitors, and has a fixed 1.8V output. An Error Flag feature monitors the output voltage and notifies the system processor when the output voltage falls more than 15% below the nominal value. The LP38511-1.8 provides excellent transient performance to meet the demand of high performance digital core ASICs, DSPs, and FPGAs found in highly-intensive applications such as servers, routers/switches, and base stations.

Features

- 2.25V to 5.5V Input Voltage Range
- 1.8V Fixed Output Voltage
- 800 mA Output Load Current
- $\pm 2.5\%$ V_{OUT} Accuracy over Line, Load, and Full-Temperature Range from -40°C to $+125^{\circ}\text{C}$
- Stable with tiny 10 μF ceramic capacitors
- 0.20% Output Voltage Load Regulation from 10 mA to 800 mA
- Enable pin
- Error Flag Indicates Status of Output Voltage
- 1 μA of Quiescent current in Shutdown
- 40dB of PSRR at 100 kHz
- Over-Temperature and Over-Current Protection
- TO263 and TO-263 THIN Surface Mount Packages

Applications

- Digital Core ASICs, FPGAs, and DSPs
- Servers
- Routers and Switches
- Base Stations
- Storage Area Networks
- DDR2 Memory

Typical Application Circuit

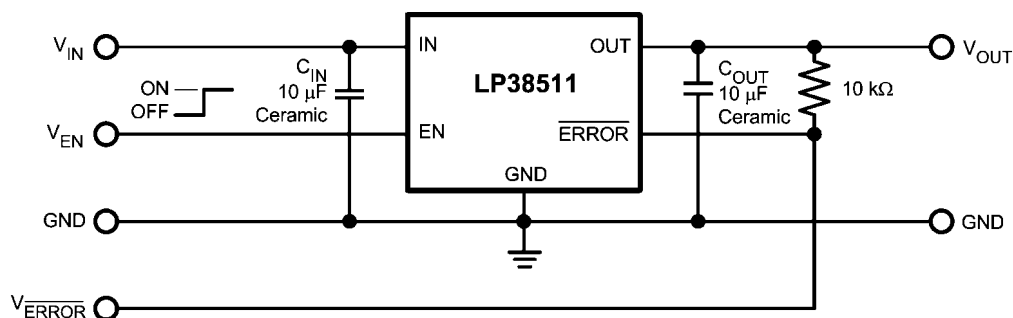

20182901

Ordering Information

TABLE 1. Package Marking and Ordering Information

Output Voltage	Order Number	Package Type	Package Marking	Supplied As:
1.8	LP38511TJ-1.8	TO263-5 THIN	LP38511TJ-1.8	Tape and Reel
	LP38511TS-1.8	TO263-5	LP38511TS-1.8	Rail
	LP38511TSX-1.8	TO263-5	LP38511TS-1.8	Tape and Reel

Connection Diagrams

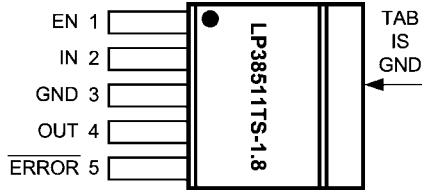

Top View
TO-263 5 Pin Package

20182904

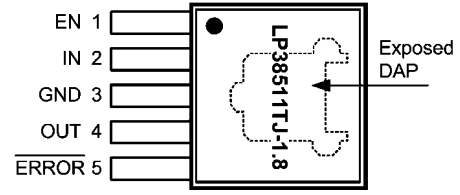

Top View
TO-263 THIN 5 Pin Package

20182905

Pin Descriptions for TO-263 and TO-263 THIN Packages

Pin #	Pin Name	Function
1	EN	Enable. Pull high to enable the output, low to disable the output. This pin has no internal bias and must be tied to the input voltage, or actively driven.
2	IN	Input Supply Pin
3	GND	Ground
4	OUT	Regulated Output Voltage Pin
5	$\overline{\text{ERROR}}$	$\overline{\text{ERROR}}$ Flag. A high level indicates that V_{OUT} is within 15% (V_{OUT} falling) of the nominal regulated voltage.
TAB/DAP	TAB/DAP	The TO-263 TAB, and the TO-263 THIN DAP, is used as a thermal connection to remove heat from the device to an external heatsink. The TAB/DAP is internally connected to device pin 3, and is electrical ground connection.

Absolute Maximum Ratings (Note 1)

If Military/Aerospace specified devices are required, please contact the National Semiconductor Sales Office/Distributors for availability and specifications.

Storage Temperature Range	-65°C to +150°C
Peak Reflow Temperature (Note 3)	
PSOP-8	260°C, 30s
TO-263	260°C, 30s
ESD Rating (Note 2)	±2 kV
Power Dissipation (Note 4)	Internally Limited
Input Pin Voltage (Survival)	-0.3V to +6.0V
Enable Pin Voltage (Survival)	-0.3V to +6.0V
Output Pin Voltage (Survival)	-0.3V to +6.0V
ERROR Pin Voltage (Survival)	0.3V to +6.0V
I _{OUT} (Survival)	Internally Limited

Operating Ratings (Note 1)

Input Supply Voltage, V _{IN}	2.25V to 5.5V
Enable Input Voltage, V _{EN}	0.0V to 5.5V
ERROR Pin Voltage	0.0V to V _{IN}
Output Current (DC)	0 mA to 800 mA
Junction Temperature (Note 4)	-40°C to +125°C

Electrical Characteristics

Unless otherwise specified: V_{IN} = 2.5V, I_{OUT} = 10 mA, C_{IN} = 10 μF, C_{OUT} = 10 μF, V_{EN} = V_{IN}. Limits in standard type are for T_J = 25°C only; limits in **boldface type** apply over the junction temperature (T_J) range of -40°C to +125°C. Minimum and Maximum limits are guaranteed through test, design, or statistical correlation. Typical values represent the most likely parametric norm at T_J = 25°C, and are provided for reference purposes only.

Symbol	Parameter	Conditions	Min	Typ	Max	Units
V _{OUT}	Output Voltage Tolerance (Note 7)	2.25V ≤ V _{IN} ≤ 5.5V 10 mA ≤ I _{OUT} ≤ 800 mA	-1.0 -2.5	0	+1.0 +2.5	%
ΔV _{OUT} /ΔV _{IN}	Output Voltage Line Regulation (Notes 5, 7)	2.25V ≤ V _{IN} ≤ 5.5V	-	0.02 0.06	-	%/V
ΔV _{OUT} /ΔI _{OUT}	Output Voltage Load Regulation (Notes 6, 7)	10 mA ≤ I _{OUT} ≤ 800 mA	-	0.25 0.40	-	%/A
V _{DO}	Dropout Voltage (Note 8)	I _{OUT} = 800 mA	-	135	225 260	mV
I _{GND}	Ground Pin Current, Output Enabled	I _{OUT} = 10 mA ERROR pin = GND	-	7.5	11 12	mA
		I _{OUT} = 800 mA ERROR pin = GND	-	9.5	13 14	
	Ground Pin Current, Output Disabled	V _{EN} = 0.50V ERROR pin = GND	-	0.1	3.5 12	μA
I _{SC}	Short Circuit Current	V _{OUT} = 0V	-	1.5	-	A

Enable Input

V _{EN(ON)}	Enable ON Threshold	V _{EN} rising from 0.50V until V _{OUT} = ON	0.90 0.80	1.20	1.50 1.60	V
V _{EN(OFF)}	Enable OFF Threshold	V _{EN} falling from 1.60V until V _{OUT} = OFF	0.60 0.50	1.00	1.40 1.50	V
V _{EN(HYS)}	Enable Hysteresis	V _{EN(ON)} - V _{EN(OFF)}	-	200	-	mV
t _{d(OFF)}	Turn-off delay	Time from V _{EN} < V _{EN(OFF)} to V _{OUT} = OFF, I _{LOAD} = 1.5A	-	1	-	μs
t _{d(ON)}	Turn-on delay	Time from V _{EN} > V _{EN(ON)} to V _{OUT} = ON, I _{LOAD} = 800 mA	-	25	-	
I _{EN}	Enable Pin Current	V _{EN} = V _{IN}	-	1	-	nA
		V _{EN} = 0V	-	-1	-	

Symbol	Parameter	Conditions	Min	Typ	Max	Units
ERROR Flag						
V_{TH}	Error Flag Threshold (Note 9)	V_{OUT} rising threshold where ERROR Flag goes high	78	90	98	%
		V_{OUT} falling threshold where ERROR Flag goes low	74	85	93	
$V_{ERROR(SAT)}$	ERROR Flag Saturation Voltage	$I_{SINK} = 1 \text{ mA}$	-	12.5	45	mV
I_{IK}	ERROR Flag Pin Leakage Current	$V_{ERROR} = 5.5V$	-	1	-	nA
t_d	ERROR Flag Delay time		-	1	-	μs
AC Parameters						
PSRR	Ripple Rejection	$V_{IN} = 2.5V$ $f = 120\text{Hz}$	-	73	-	dB
		$V_{IN} = 2.5V$ $f = 1 \text{ kHz}$	-	73	-	
e_n	Output Noise Density	$f = 120\text{Hz}$	-	2	-	$\text{nV}/\sqrt{\text{Hz}}$
	Output Noise Voltage	$\text{BW} = 100\text{Hz} - 100\text{kHz}$	-	75	-	$\mu\text{V (rms)}$
Thermal Characteristics						
T_{SD}	Thermal Shutdown	T_J rising	-	165	-	$^{\circ}\text{C}$
ΔT_{SD}	Thermal Shutdown Hysteresis	T_J falling from T_{SD}	-	10	-	
θ_{JA}	Thermal Resistance Junction to Ambient (Note 4)	TO-263 and TO-263 THIN	-	60	-	$^{\circ}\text{C/W}$
		PSOP-8	-	168	-	
θ_{JC}	Thermal Resistance Junction to Case	TO-263 and TO-263 THIN	-	3	-	$^{\circ}\text{C/W}$
		PSOP-8	-	11	-	
<p>Note 1: Absolute Maximum Ratings indicate limits beyond which damage to the device may occur. Operating Ratings indicate conditions for which the device is intended to be functional, but does not guarantee specific performance limits. For guaranteed specifications and conditions, see the Electrical Characteristics.</p> <p>Note 2: The human body model is a 100pF capacitor discharged through a 1.5kΩ resistor into each pin. Test method is per JESD22-A114.</p> <p>Note 3: Refer to JEDEC J-STD-020C for surface mount device (SMD) package reflow profiles and conditions. Unless otherwise stated, the temperatures and times are for Sn-Pb (STD) only.</p> <p>Note 4: Device operation must be evaluated, and derated as needed, based on ambient temperature (T_A), power dissipation (P_D), maximum allowable operating junction temperature ($T_{J(MAX)}$), and package thermal resistance (θ_{JA}).</p> <p>Note 5: Output voltage line regulation is defined as the change in output voltage from the nominal value (ΔV_{OUT}) due to a change in the voltage at the input (ΔV_{IN}).</p> <p>Note 6: Output voltage load regulation is defined as the change in output voltage from the nominal value (ΔV_{OUT}) due to a change in the load current at the output (ΔI_{OUT}).</p> <p>Note 7: The line and load regulation specification contains only the typical number. However, the limits for line and load regulation are included in the output voltage tolerance specification.</p> <p>Note 8: Dropout voltage is defined as the minimum input to output differential voltage at which the output drops 2% below the nominal value. For the LP38511-1.8, the minimum V_{IN} operating voltage is the limiting factor.</p> <p>Note 9: The ERROR Flag thresholds are specified as percentage of the nominal regulated output voltage. See Application Information.</p>						

Typical Performance Characteristics

Unless otherwise specified: $T_J = 25^\circ\text{C}$, $V_{IN} = 2.5\text{V}$, $V_{EN} = V_{IN}$,

$C_{IN} = 10\ \mu\text{F}$, $C_{OUT} = 10\ \mu\text{F}$, $I_{OUT} = 10\ \text{mA}$.

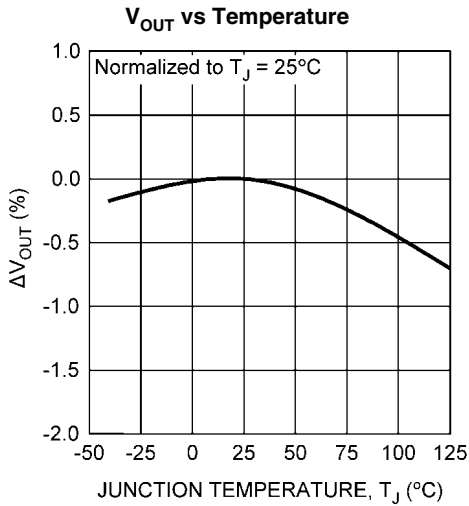

20182911

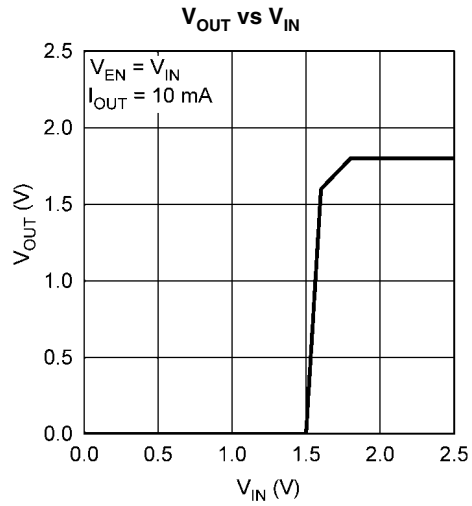

20182937

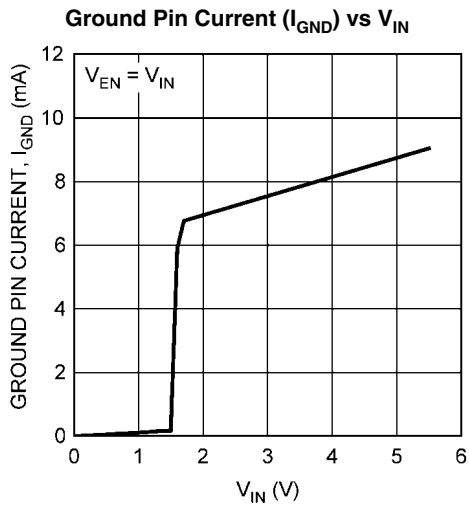

20182912

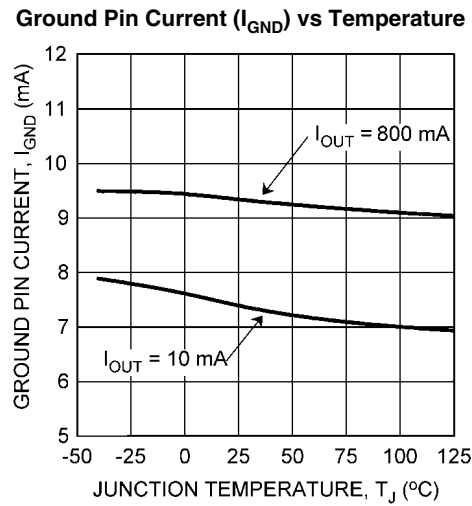

20182913

Ground Pin Current (I_{GND}) vs Temperature, $V_{EN} = 0.5\text{V}$

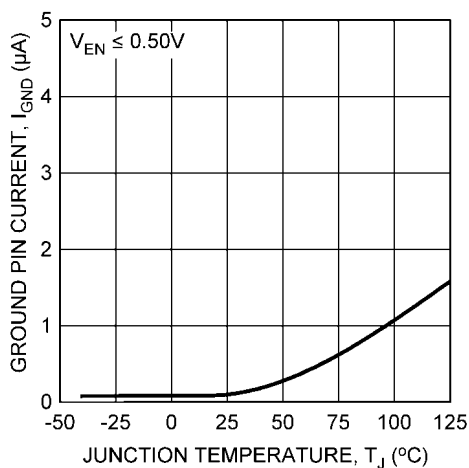

20182914

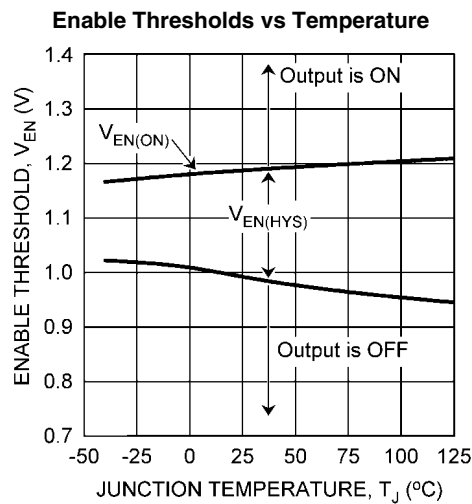

20182916

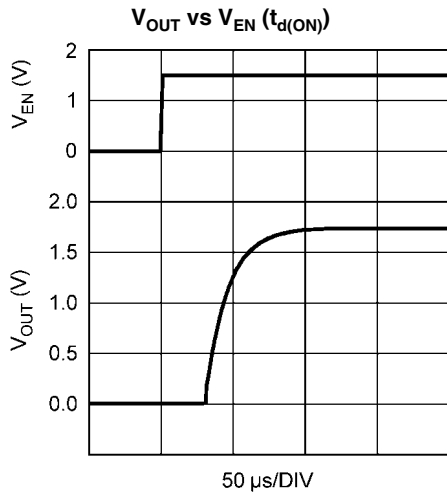

20182932

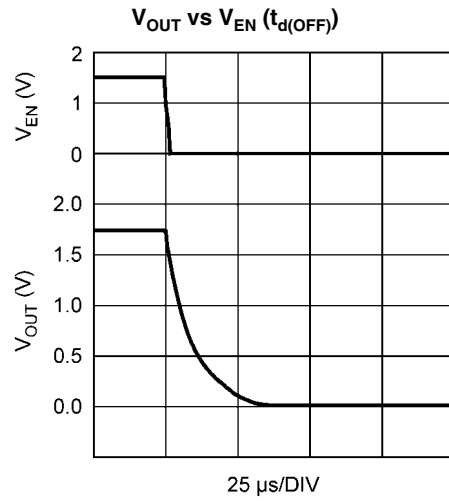

20182930

V_{OUT} ERROR Flag Threshold vs Temperature

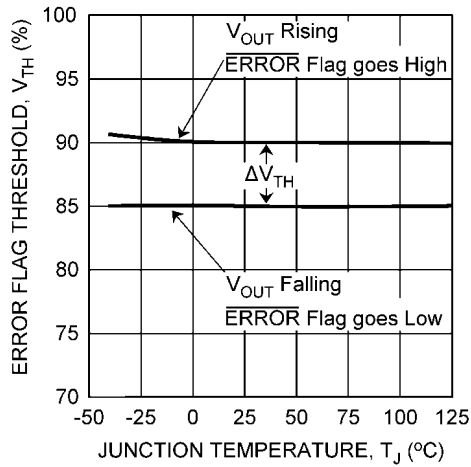

20182917

ERROR Flag Low vs Temperature

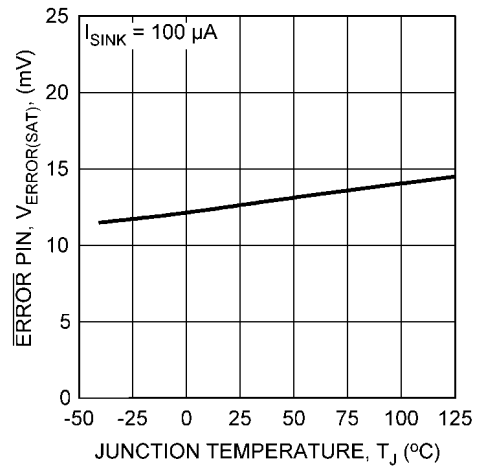

20182918

Load regulation vs Temperature

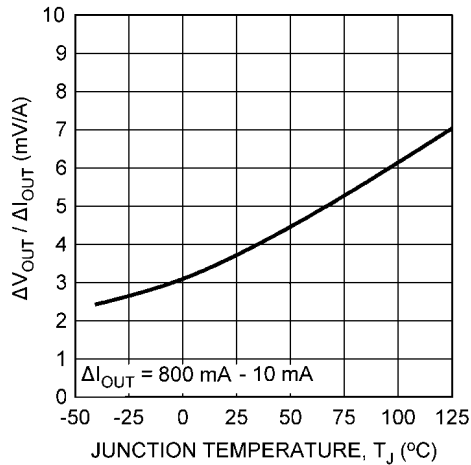

20182920

Line Regulation vs Temperature

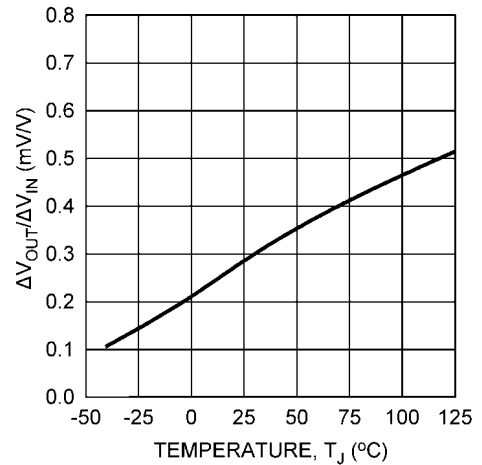

20182921

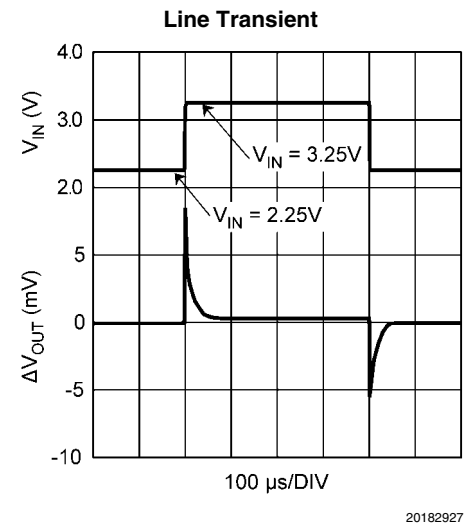
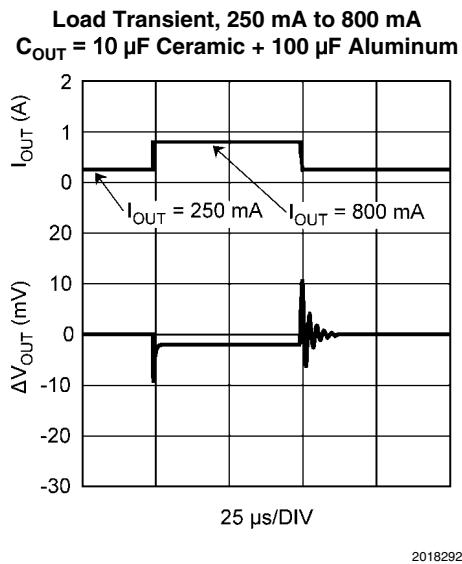
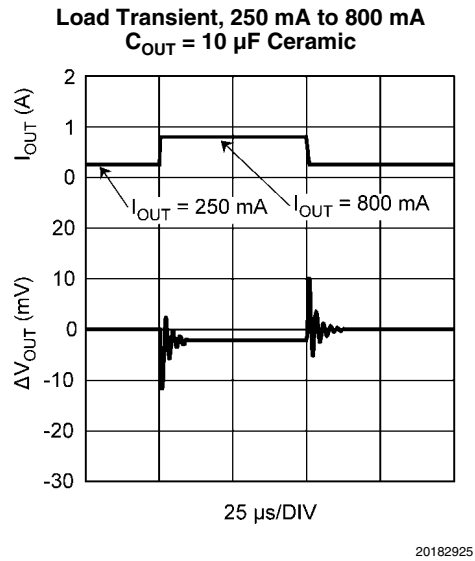
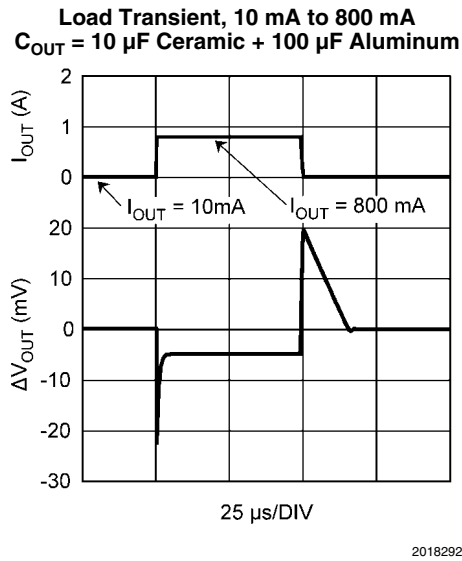
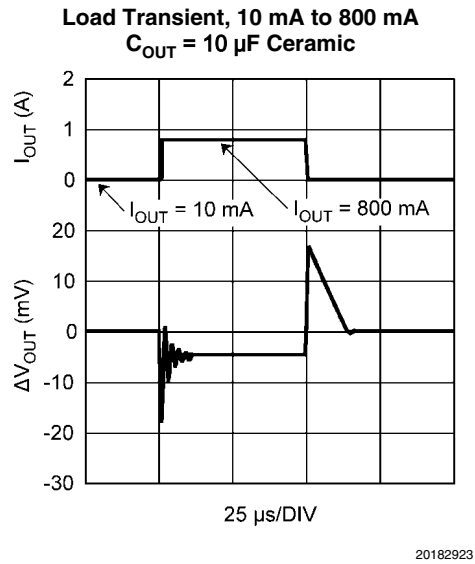
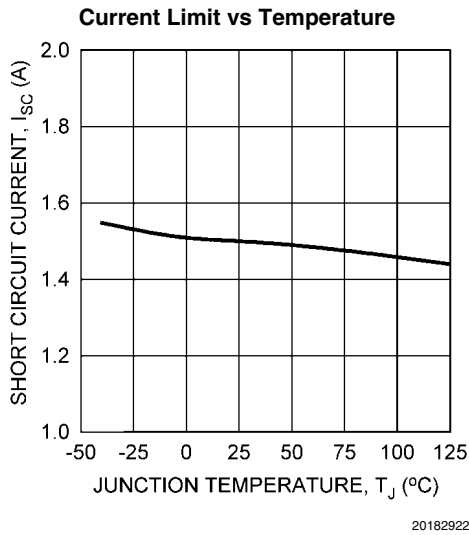

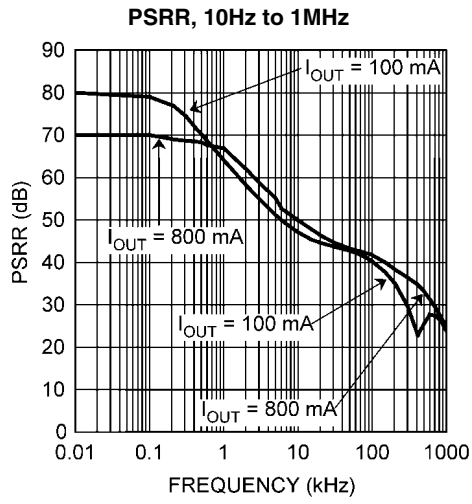

20182929

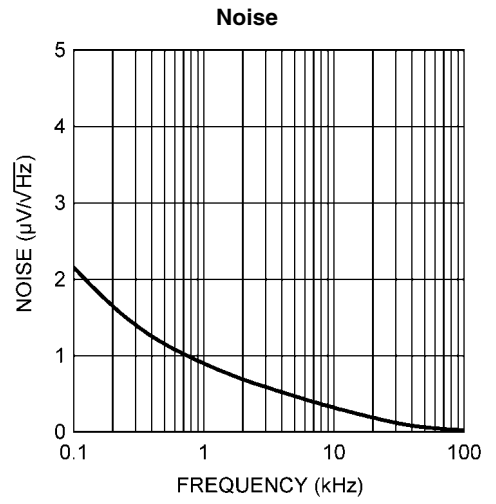

20182931

Block Diagram

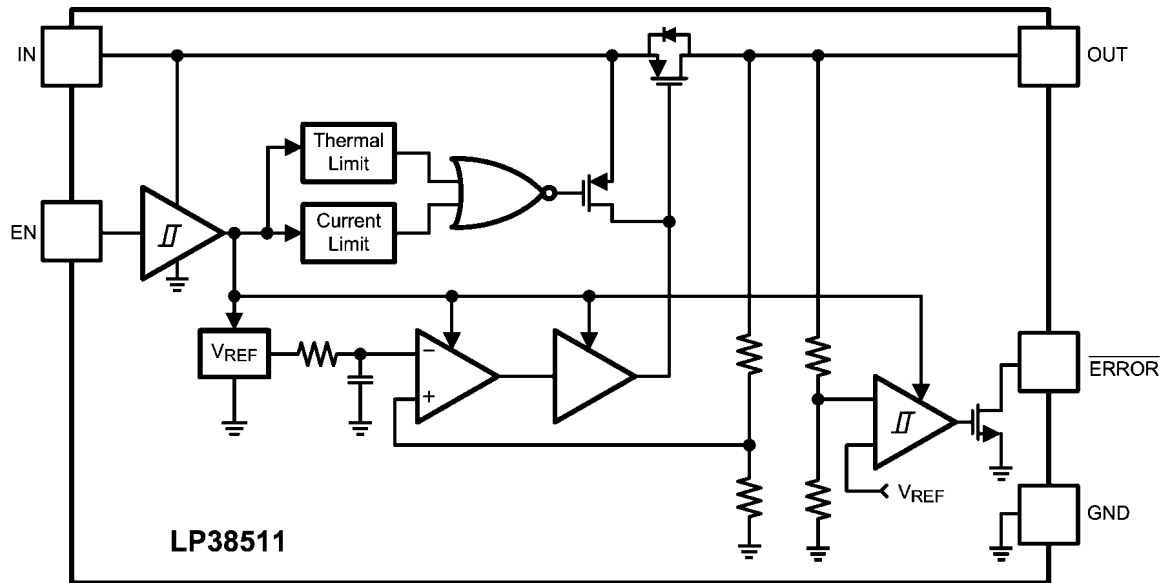

20182907

Application Information

EXTERNAL CAPACITORS

Like any low-dropout regulator, external capacitors are required to assure stability. These capacitors must be correctly selected for proper performance.

Input Capacitor

A ceramic input capacitor of at least 10 μF is required. For general usage across all load currents and operating conditions, a 10 μF ceramic input capacitor will provide satisfactory performance.

Output Capacitor

A ceramic capacitor with a minimum value of 10 μF is required at the output pin for loop stability. It must be located less than 1 cm from the device and connected directly to the output and ground pin using traces which have no other currents flowing through them. As long as the minimum of 10 μF ceramic is met, there is no limitation on any additional capacitance.

X7R and X5R dielectric ceramic capacitors are strongly recommended, as they typically maintain a capacitance range within $\pm 20\%$ of nominal over full operating ratings of temperature and voltage. Of course, they are typically larger and more costly than Z5U/Y5U types for a given voltage and capacitance.

Z5U and Y5V dielectric ceramics are not recommended as the capacitance will drop severely with applied voltage. A typical Z5U or Y5V capacitor can lose 60% of its rated capacitance with half of the rated voltage applied to it. The Z5U and Y5V also exhibit a severe temperature effect, losing more than 50% of nominal capacitance at high and low limits of the temperature range.

REVERSE VOLTAGE

A reverse voltage condition will exist when the voltage at the output pin is higher than the voltage at the input pin. Typically this will happen when V_{IN} is abruptly taken low and C_{OUT} continues to hold a sufficient charge such that the input to output

voltage becomes reversed. A less common condition is when an alternate voltage source is connected to the output.

There are two possible paths for current to flow from the output pin back to the input during a reverse voltage condition.

While V_{IN} is high enough to keep the control circuitry alive, and the Enable pin is above the $V_{\text{EN(ON)}}$ threshold, the control circuitry will attempt to regulate the output voltage. Since the input voltage is less than the output voltage the control circuit will drive the gate of the pass element to the full on condition when the output voltage begins to fall. In this condition, reverse current will flow from the output pin to the input pin, limited only by the $R_{\text{DS(ON)}}$ of the pass element and the output to input voltage differential. Discharging an output capacitor up to 1000 μF in this manner will not damage the device as the current will rapidly decay. However, continuous reverse current should be avoided.

The internal PFET pass element in the LP38511 has an inherent parasitic diode. During normal operation, the input voltage is higher than the output voltage and the parasitic diode is reverse biased. However, if the output voltage to input voltage differential is more than 500 mV (typical) the parasitic diode becomes forward biased and current flows from the output pin to the input through the diode. The current in the parasitic diode should be limited to less than 1A continuous and 5A peak.

If used in a dual-supply system where the regulator output load is returned to a negative supply, the output pin must be diode clamped to ground. A Schottky diode is recommended for this protective clamp.

SHORT-CIRCUIT PROTECTION

The LP38511 is short circuit protected, and in the event of a peak over-current condition the short-circuit control loop will rapidly drive the output PMOS pass element off. Once the power pass element shuts down, the control loop will rapidly cycle the output on and off until the average power dissipation causes the thermal shutdown circuit to respond to servo the

on/off cycling to a lower frequency. Please refer to the *POWER DISSIPATION/HEATSINKING* section for power dissipation calculations.

ENABLE OPERATION

The Enable ON threshold is typically 1.2V, and the OFF threshold is typically 1.0V. To ensure reliable operation the Enable pin voltage must rise above the maximum $V_{EN(ON)}$ threshold and must fall below the minimum $V_{EN(OFF)}$ threshold. The Enable threshold has typically 200mV of hysteresis to improve noise immunity.

The Enable pin (EN) has no internal pull-up or pull-down to establish a default condition and, as a result, this pin must be terminated either actively or passively.

If the Enable pin is driven from a single ended device (such as discrete transistor) a pull-up resistor to V_{IN} , or a pull-down resistor to ground, will be required for proper operation. A 1 k Ω to 100 k Ω resistor can be used as the pull-up or pull-down resistor to establish default condition for the EN pin. The resistor value selected should be appropriate to swamp out any leakage in the external single ended device, as well as any stray capacitance.

If the Enable pin is driven from a source that actively pulls high and low (such as a CMOS rail to rail comparator output), the pull-up, or pull-down, resistor is not required.

If the application does not require the Enable function, the pin should be connected to directly to the adjacent V_{IN} pin.

The status of the Enable pin also affects the behavior of the $\overline{\text{ERROR}}$ Flag. While the Enable pin is high the regulator control loop will be active and the $\overline{\text{ERROR}}$ Flag will report the status of the output voltage. When the Enable pin is taken low the regulator control loop is shutdown, the output is turned off, and the $\overline{\text{ERROR}}$ Flag pin is immediately forced low.

ERROR FLAG OPERATION

When the LP38511 Enable pin is high, the $\overline{\text{ERROR}}$ Flag pin will produce a logic low signal when the output drops by more than 15% from the nominal output voltage. The drop in output voltage may be due to low input voltage, current limiting, or thermal limiting. This flag has a built in hysteresis. The output voltage will typically need to rise to within 10% (typical) of the nominal output voltage for the $\overline{\text{ERROR}}$ Flag to return to a logic high state. It should also be noted that when the Enable pin is pulled low, the $\overline{\text{ERROR}}$ Flag pin is forced to be low as well.

The internal $\overline{\text{ERROR}}$ flag comparator has an open drain output stage. Hence, the $\overline{\text{ERROR}}$ pin requires an external pull-up resistor. The value of the pull-up resistor should be in the range of 10 k Ω to 1 M Ω . The $\overline{\text{ERROR}}$ Flag pin should not be pulled-up to any voltage source higher than V_{IN} as current flow through an internal parasitic diode may cause unexpected behavior. The $\overline{\text{ERROR}}$ Flag must be connected to ground if this function is not used.

The timing diagram in *Figure 1* shows the relationship between the $\overline{\text{ERROR}}$ flag and the output voltage.

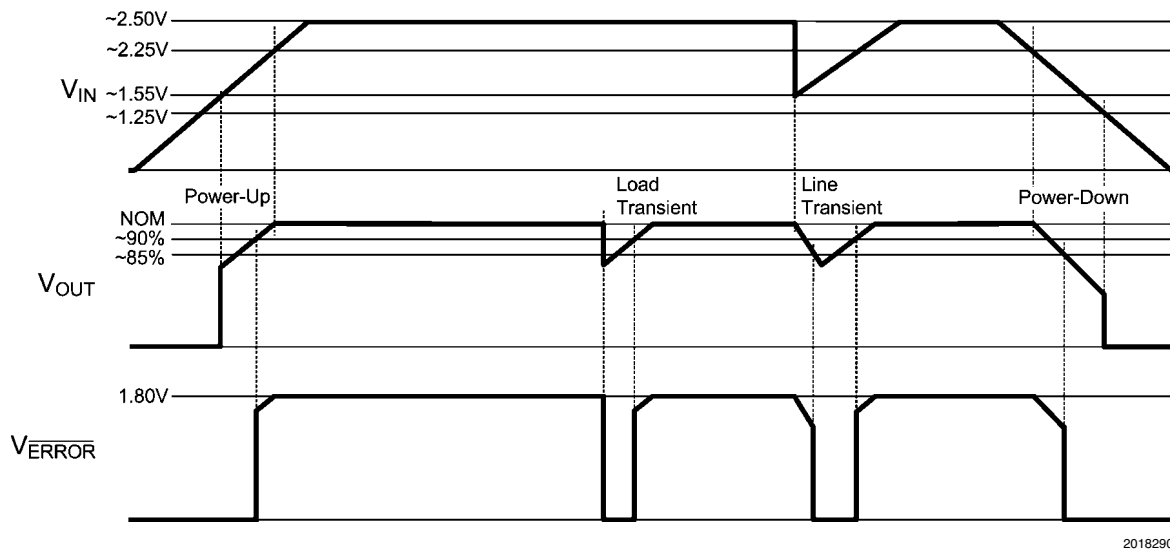

20182908

FIGURE 1. $\overline{\text{ERROR}}$ Flag Operation, see Typical Application

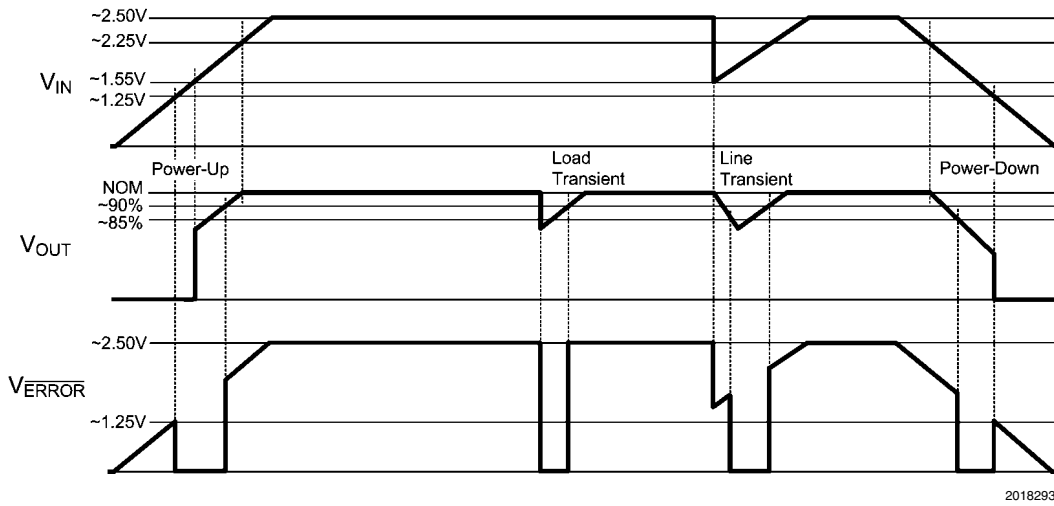

FIGURE 2. $\overline{V_{ERROR}}$ Flag Operation, biased from V_{IN}

POWER DISSIPATION/HEATSINKING

A heatsink may be required depending on the maximum power dissipation ($P_{D(MAX)}$), maximum ambient temperature ($T_{A(MAX)}$) of the application, and the thermal resistance (θ_{JA}) of the package. Under all possible conditions, the junction temperature (T_J) must be within the range specified in the Operating Ratings. The total power dissipation of the device is given by:

$$P_D = ((V_{IN} - V_{OUT}) \times I_{OUT}) + (V_{IN} \times I_{GND}) \quad (1)$$

where I_{GND} is the operating ground current of the device (specified under Electrical Characteristics).

The maximum allowable junction temperature rise (ΔT_J) depends on the maximum expected ambient temperature ($T_{A(MAX)}$) of the application, and the maximum allowable junction temperature ($T_{J(MAX)}$):

$$\Delta T_J = T_{J(MAX)} - T_{A(MAX)} \quad (2)$$

The maximum allowable value for junction to ambient Thermal Resistance, θ_{JA} , can be calculated using the formula:

$$\theta_{JA} = \Delta T_J / P_{D(MAX)} \quad (3)$$

HEATSINKING TO-263 PACKAGE

The TO-263 and the TO-263 THIN packages use the copper plane on the PCB as a heatsink. The tab, or DAP, of these packages are soldered to the copper plane for heat sinking. Figure 3 shows a curve for the θ_{JA} of TO-263 package for different copper area sizes, using a typical PCB with 1 ounce copper and no solder mask over the copper area for heat sinking.

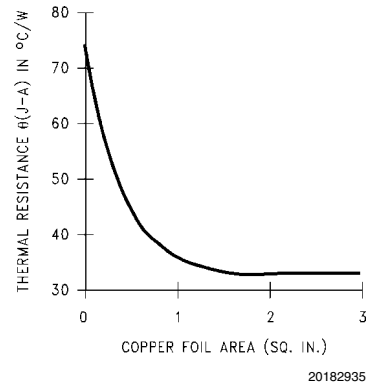

FIGURE 3. θ_{JA} vs Copper (1 Ounce) Area for TO-263 package

As shown in the figure, increasing the copper area beyond 1 square inch produces very little improvement. The minimum value for θ_{JA} for the TO-263 package mounted to a two-layer PCB is 32 $^{\circ}C/W$.

Figure 4 shows the maximum allowable power dissipation for TO-263 packages for different ambient temperatures, assuming θ_{JA} is 35 $^{\circ}C/W$ and the maximum junction temperature is 125 $^{\circ}C$.

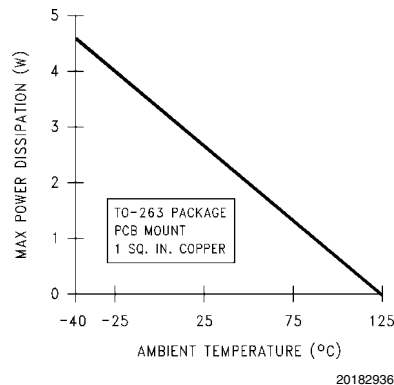
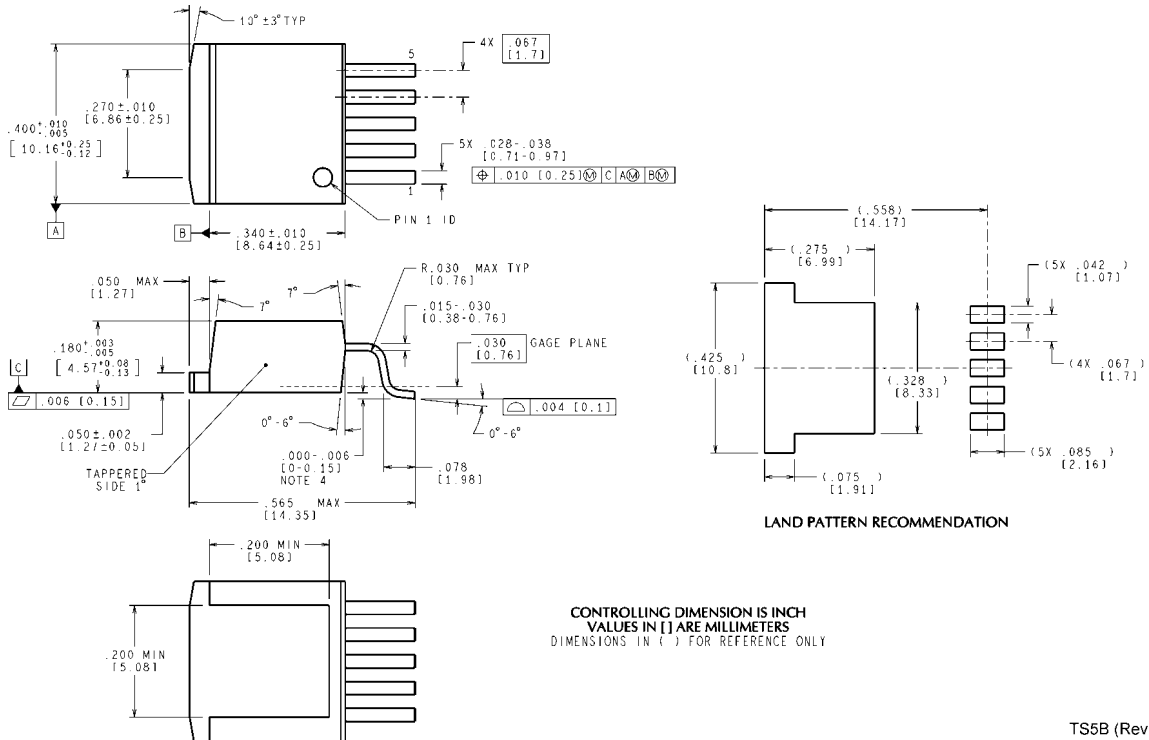
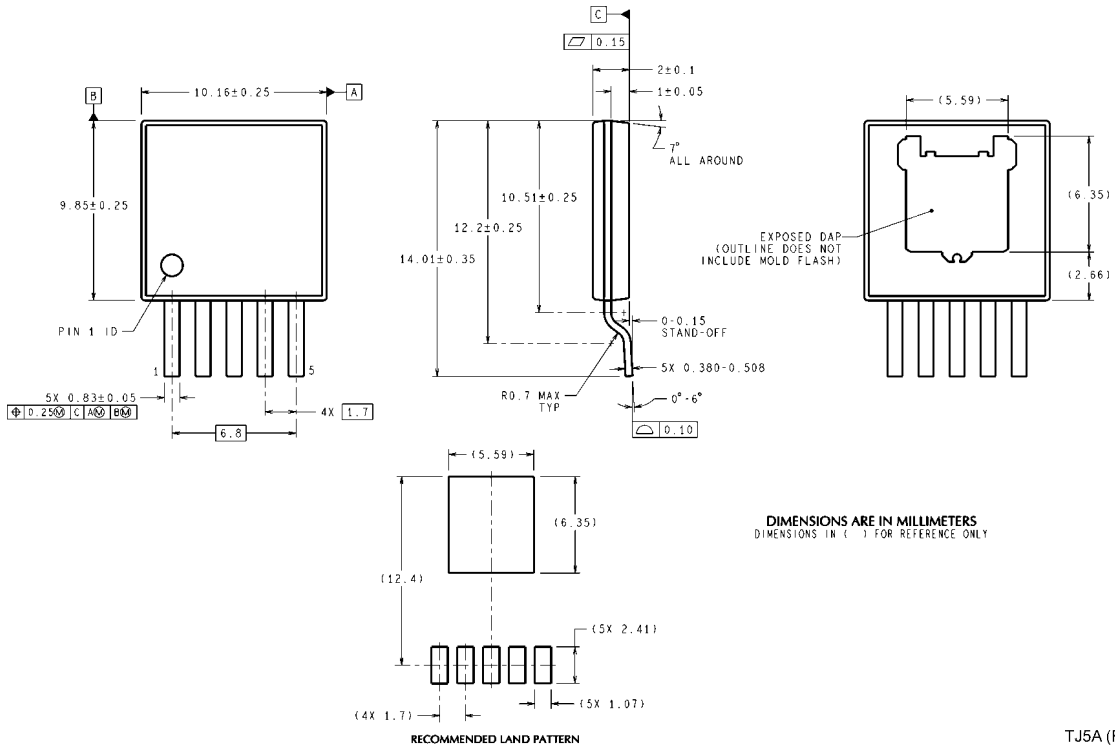

FIGURE 4. Maximum Power Dissipation vs Ambient Temperature for TO-263 Package

Physical Dimensions inches (millimeters) unless otherwise noted



**TO-263, Molded, 5 Lead, 0.067in (1.7mm) Pitch, Surface Mount Package
NS Package Number TS5B**



**TO-263 THIN, Molded, 5 Lead, 1.7mm Pitch, Surface Mount Package
NS Package Number TJ5A**

Notes

LP38511-1.8

Notes

For more National Semiconductor product information and proven design tools, visit the following Web sites at:

Products		Design Support	
Amplifiers	www.national.com/amplifiers	WEBENCH® Tools	www.national.com/webench
Audio	www.national.com/audio	App Notes	www.national.com/appnotes
Clock and Timing	www.national.com/timing	Reference Designs	www.national.com/refdesigns
Data Converters	www.national.com/adc	Samples	www.national.com/samples
Interface	www.national.com/interface	Eval Boards	www.national.com/evalboards
LVDS	www.national.com/lvds	Packaging	www.national.com/packaging
Power Management	www.national.com/power	Green Compliance	www.national.com/quality/green
Switching Regulators	www.national.com/switchers	Distributors	www.national.com/contacts
LDOs	www.national.com/ldo	Quality and Reliability	www.national.com/quality
LED Lighting	www.national.com/led	Feedback/Support	www.national.com/feedback
Voltage Reference	www.national.com/vref	Design Made Easy	www.national.com/easy
PowerWise® Solutions	www.national.com/powerwise	Solutions	www.national.com/solutions
Serial Digital Interface (SDI)	www.national.com/sdi	Mil/Aero	www.national.com/milaero
Temperature Sensors	www.national.com/tempsensors	SolarMagic™	www.national.com/solarmagic
Wireless (PLL/VCO)	www.national.com/wireless	Analog University®	www.national.com/AU

THE CONTENTS OF THIS DOCUMENT ARE PROVIDED IN CONNECTION WITH NATIONAL SEMICONDUCTOR CORPORATION ("NATIONAL") PRODUCTS. NATIONAL MAKES NO REPRESENTATIONS OR WARRANTIES WITH RESPECT TO THE ACCURACY OR COMPLETENESS OF THE CONTENTS OF THIS PUBLICATION AND RESERVES THE RIGHT TO MAKE CHANGES TO SPECIFICATIONS AND PRODUCT DESCRIPTIONS AT ANY TIME WITHOUT NOTICE. NO LICENSE, WHETHER EXPRESS, IMPLIED, ARISING BY ESTOPPEL OR OTHERWISE, TO ANY INTELLECTUAL PROPERTY RIGHTS IS GRANTED BY THIS DOCUMENT.

TESTING AND OTHER QUALITY CONTROLS ARE USED TO THE EXTENT NATIONAL DEEMS NECESSARY TO SUPPORT NATIONAL'S PRODUCT WARRANTY. EXCEPT WHERE MANDATED BY GOVERNMENT REQUIREMENTS, TESTING OF ALL PARAMETERS OF EACH PRODUCT IS NOT NECESSARILY PERFORMED. NATIONAL ASSUMES NO LIABILITY FOR APPLICATIONS ASSISTANCE OR BUYER PRODUCT DESIGN. BUYERS ARE RESPONSIBLE FOR THEIR PRODUCTS AND APPLICATIONS USING NATIONAL COMPONENTS. PRIOR TO USING OR DISTRIBUTING ANY PRODUCTS THAT INCLUDE NATIONAL COMPONENTS, BUYERS SHOULD PROVIDE ADEQUATE DESIGN, TESTING AND OPERATING SAFEGUARDS.

EXCEPT AS PROVIDED IN NATIONAL'S TERMS AND CONDITIONS OF SALE FOR SUCH PRODUCTS, NATIONAL ASSUMES NO LIABILITY WHATSOEVER, AND NATIONAL DISCLAIMS ANY EXPRESS OR IMPLIED WARRANTY RELATING TO THE SALE AND/OR USE OF NATIONAL PRODUCTS INCLUDING LIABILITY OR WARRANTIES RELATING TO FITNESS FOR A PARTICULAR PURPOSE, MERCHANTABILITY, OR INFRINGEMENT OF ANY PATENT, COPYRIGHT OR OTHER INTELLECTUAL PROPERTY RIGHT.

LIFE SUPPORT POLICY

NATIONAL'S PRODUCTS ARE NOT AUTHORIZED FOR USE AS CRITICAL COMPONENTS IN LIFE SUPPORT DEVICES OR SYSTEMS WITHOUT THE EXPRESS PRIOR WRITTEN APPROVAL OF THE CHIEF EXECUTIVE OFFICER AND GENERAL COUNSEL OF NATIONAL SEMICONDUCTOR CORPORATION. As used herein:

Life support devices or systems are devices which (a) are intended for surgical implant into the body, or (b) support or sustain life and whose failure to perform when properly used in accordance with instructions for use provided in the labeling can be reasonably expected to result in a significant injury to the user. A critical component is any component in a life support device or system whose failure to perform can be reasonably expected to cause the failure of the life support device or system or to affect its safety or effectiveness.

National Semiconductor and the National Semiconductor logo are registered trademarks of National Semiconductor Corporation. All other brand or product names may be trademarks or registered trademarks of their respective holders.

Copyright© 2009 National Semiconductor Corporation

For the most current product information visit us at www.national.com



**National Semiconductor
Americas Technical
Support Center**
Email: support@nsc.com
Tel: 1-800-272-9959

**National Semiconductor Europe
Technical Support Center**
Email: europe.support@nsc.com

**National Semiconductor Asia
Pacific Technical Support Center**
Email: ap.support@nsc.com

**National Semiconductor Japan
Technical Support Center**
Email: jpn.feedback@nsc.com