

500mA Low Dropout CMOS Linear Regulators with Adjustable Output *Stable with Ceramic Output Capacitors*

General Description

The LP38691/3-ADJ low dropout CMOS linear regulators provide 2.0% precision reference voltage, extremely low dropout voltage (250mV @ 500mA load current, $V_{OUT} = 5V$) and excellent AC performance utilizing ultra low ESR ceramic output capacitors.

The low thermal resistance of the LLP and SOT-223 packages allow the full operating current to be used even in high ambient temperature environments.

The use of a PMOS power transistor means that no DC base drive current is required to bias it allowing ground pin current to remain below 100 μA regardless of load current, input voltage, or operating temperature.

Dropout Voltage: 250 mV (typ) @ 500mA (typ. 5V out).

Ground Pin Current: 55 μA (typ) at full load.

Adjust Pin Voltage: 2.0% (25°C) accuracy.

Features

- LP38691QSD-ADJ is AEC-Q100 Grade 1
- Output voltage range of 1.25V - 9V
- 2.0% adjust pin voltage accuracy (25°C)
- Low dropout voltage: 250mV @ 500mA (typ, 5V out)
- Wide input voltage range (2.7V to 10V)
- Precision (trimmed) bandgap reference
- Guaranteed specs for -40°C to +125°C
- 1 μA off-state quiescent current
- Thermal overload protection
- Foldback current limiting
- SOT-223 and 6-Lead LLP packages
- Enable pin (LP38693-ADJ)

Applications

- Hard Disk Drives
- Notebook Computers
- Battery Powered Devices
- Portable Instrumentation

Typical Application Circuits

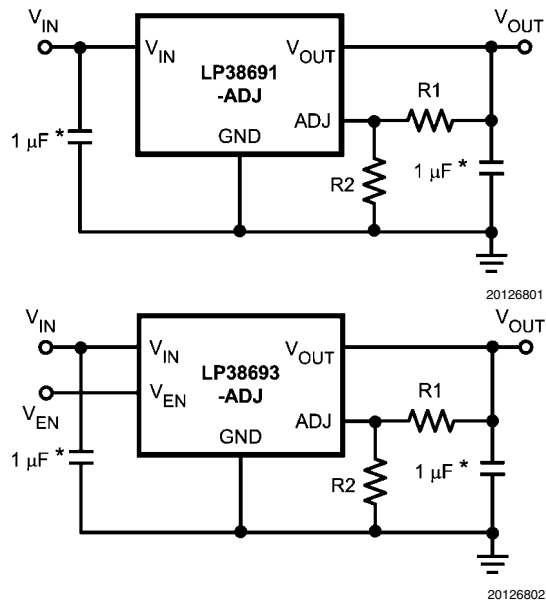

$$V_{OUT} = V_{ADJ} \times (1 + R1/R2)$$

Note: *Minimum value required for stability.

Connection Diagrams

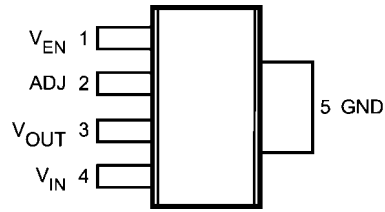

SOT-223, Top View
LP38693MP-ADJ

20126803

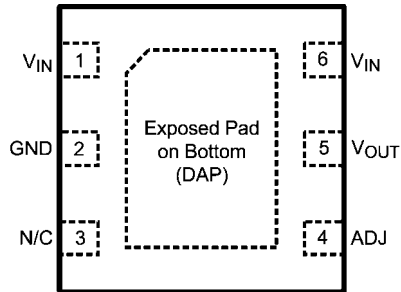

6-Lead LLP, Top View
LP38691SD-ADJ

20126804

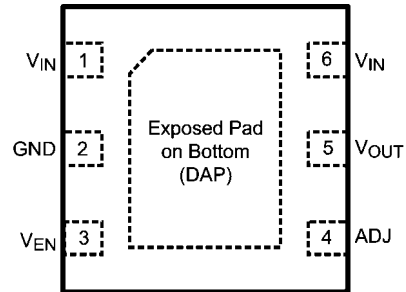

6-Lead LLP, Top View
LP38693SD-ADJ

20126805

Pin Descriptions

Pin	Description
V_{IN}	This is the input supply voltage to the regulator. For LLP package devices, both V_{IN} pins must be tied together for full current operation (250mA maximum per pin).
GND	Circuit ground for the regulator. For the SOT-223 package this is thermally connected to the die and functions as a heat sink when the soldered down to a large copper plane.
V_{OUT}	Regulated output voltage.
V_{EN}	The enable pin allows the part to be turned ON and OFF by pulling this pin high or low.
ADJ	The adjust pin is used to set the regulated output voltage by connecting it to the external resistors R1 and R2 (see Typical Application Circuit).
DAP	LLP Only - The DAP (Exposed Pad) functions as a thermal connection when soldered to a copper plane. See LLP MOUNTING section in Application Hints for more information.

Ordering Information

Order Number	Grade	Package Marking	Package Type	Package Drawing	Supplied As
LP38691SD-ADJ	Standard	L117B	6-Lead LLP	SDE06A	1000 Units Tape and Reel
LP38691SDX-ADJ	Standard	L117B	6-Lead LLP	SDE06A	4500 Units Tape and Reel
LP38691QSD-ADJ	Automotive	L251B	6-Lead LLP	SDE06A	1000 Units Tape and Reel
LP38691QSDX-ADJ	Automotive	L251B	6-Lead LLP	SDE06A	4500 Units Tape and Reel
LP38693MP-ADJ	Standard	LJUB	SOT-223	MP05A	1000 Units Tape and Reel
LP38693MPX-ADJ	Standard	LJUB	SOT-223	MP05A	2000 Units Tape and Reel
LP38693SD-ADJ	Standard	L127B	6-Lead LLP	SDE06A	1000 Units Tape and Reel
LP38693SDX-ADJ	Standard	L127B	6-Lead LLP	SDE06A	4500 Units Tape and Reel

Automotive Grade (Q) product incorporates enhanced manufacturing and support processes for the automotive market, including defect detection methodologies. Reliability qualification is compliant with the requirements and temperature grades defined in the AEC Q100 standard. Automotive Grade products are identified with the letter Q. For more information go to: <http://www.national.com/automotive>

For LP38691-ADJ Ordering and Availability Information see: <http://www.national.com/pf/LP/LP38691-ADJ.html#Order>

For LP38693-ADJ Ordering and Availability Information see: <http://www.national.com/pf/LP/LP38693-ADJ.html#Order>

Absolute Maximum Ratings *(Note 1)*

If Military/Aerospace specified devices are required, please contact the National Semiconductor Sales Office/Distributors for availability and specifications.

Storage Temperature Range	-65°C to +150°C
Lead Temp. (Soldering, 5 seconds)	260°C
ESD Rating <i>(Note 3)</i>	2 kV
Power Dissipation <i>(Note 2)</i>	Internally Limited
V(max) All pins (with respect to GND)	-0.3V to 12V
I _{OUT}	Internally Limited
Junction Temperature	-40°C to +150°C

Operating Ratings

V _{IN} Supply Voltage	2.7V to 10V
Operating Junction Temperature Range	-40°C to +125°C

Electrical Characteristics

Limits in standard typeface are for T_J = 25°C, and limits in **boldface type** apply over the full operating temperature range. Unless otherwise specified: V_{IN} = V_{OUT} + 1V, C_{IN} = C_{OUT} = 10 μF, I_{LOAD} = 10mA. Min/Max limits are guaranteed through testing, statistical correlation, or design.

Symbol	Parameter	Conditions	Min	Typ <i>(Note 4)</i>	Max	Units
V _{ADJ}	ADJ Pin Voltage	V _{IN} = 2.7V	1.225	1.25	1.275	V
		3.2V ≤ V _{IN} ≤ 10V 100 μA < I _L < 0.5A	1.200	1.25	1.300	
ΔV _O /ΔV _{IN}	Output Voltage Line Regulation <i>(Note 6)</i>	V _O + 0.5V ≤ V _{IN} ≤ 10V I _L = 25mA		0.03	0.1	%/V
ΔV _O /ΔI _L	Output Voltage Load Regulation <i>(Note 7)</i>	1 mA < I _L < 0.5A V _{IN} = V _O + 1V		1.8	5	%/A
V _{IN} - V _O	Dropout Voltage <i>(Note 8)</i>	(V _O = 2.5V) I _L = 0.1A I _L = 0.5A		80 430	145 725	mV
		(V _O = 3.3V) I _L = 0.1A I _L = 0.5A		65 330	110 550	
		(V _O = 5V) I _L = 0.1A I _L = 0.5A		45 250	100 450	
I _Q	Quiescent Current	V _{IN} ≤ 10V, I _L = 100 μA - 0.5A		55	100	μA
		V _{EN} ≤ 0.4V, (LP38693-ADJ Only)		0.001	1	
I _L (MIN)	Minimum Load Current	V _{IN} - V _O ≤ 4V			100	
I _{FB}	Foldback Current Limit	V _{IN} - V _O > 5V		350		mA
		V _{IN} - V _O < 4V		850		
PSRR	Ripple Rejection	V _{IN} = V _O + 2V(DC), with 1V(p-p) / 120Hz Ripple		55		dB
T _{SD}	Thermal Shutdown Activation (Junction Temp)			160		°C
T _{SD} (HYST)	Thermal Shutdown Hysteresis (Junction Temp)			10		
I _{ADJ}	ADJ Input Leakage Current	V _{ADJ} = 0 - 1.5V V _{IN} = 10V	-100	0.01	100	nA

Symbol	Parameter	Conditions	Min	Typ (Note 4)	Max	Units
e_n	Output Noise	BW = 10Hz to 10kHz $V_O = 3.3V$		0.7		$\mu V/\sqrt{Hz}$
V_O (LEAK)	Output Leakage Current	$V_O = V_O(NOM) + 1V @ V_{IN} = 10V$		0.5	2	μA
V_{EN}	Enable Voltage (LP38693-ADJ Only)	Output = OFF			0.4	V
		Output = ON, $V_{IN} = 4V$	1.8			
		Output = ON, $V_{IN} = 6V$	3.0			
		Output = ON, $V_{IN} = 10V$	4.0			
I_{EN}	Enable Pin Leakage (LP38693-ADJ Only)	$V_{EN} = 0V$ or $10V$, $V_{IN} = 10V$	-1	0.001	1	μA

Note 1: Absolute maximum ratings indicate limits beyond which damage to the component may occur. Operating ratings indicate conditions for which the device is intended to be functional, but do not guarantee specific performance limits. For guaranteed specifications, see Electrical Characteristics. Specifications do not apply when operating the device outside of its rated operating conditions.

Note 2: At elevated temperatures, device power dissipation must be derated based on package thermal resistance and heatsink values (if a heatsink is used). The junction-to-ambient thermal resistance (θ_{JA}) for the SOT-223 is approximately 125 °C/W for a PC board mounting with the device soldered down to minimum copper area (less than 0.1 square inch). If one square inch of copper is used as a heat dissipator for the SOT-223, the θ_{JA} drops to approximately 70 °C/W. The θ_{JA} values for the LLP package are also dependent on trace area, copper thickness, and the number of thermal vias used (refer to application note AN-1187 and the [LLP MOUNTING](#) section in this datasheet). If power dissipation causes the junction temperature to exceed specified limits, the device will go into thermal shutdown.

Note 3: ESD is tested using the human body model which is a 100pF capacitor discharged through a 1.5k resistor into each pin.

Note 4: Typical numbers represent the most likely parametric norm for 25°C operation.

Note 5: If used in a dual-supply system where the regulator load is returned to a negative supply, the output pin must be diode clamped to ground.

Note 6: Output voltage line regulation is defined as the change in output voltage from nominal value resulting from a change in input voltage.

Note 7: Output voltage load regulation is defined as the change in output voltage from nominal value as the load current increases from 1mA to full load.

Note 8: Dropout voltage is defined as the minimum input to output differential required to maintain the output within 100mV of nominal value.

Block Diagrams

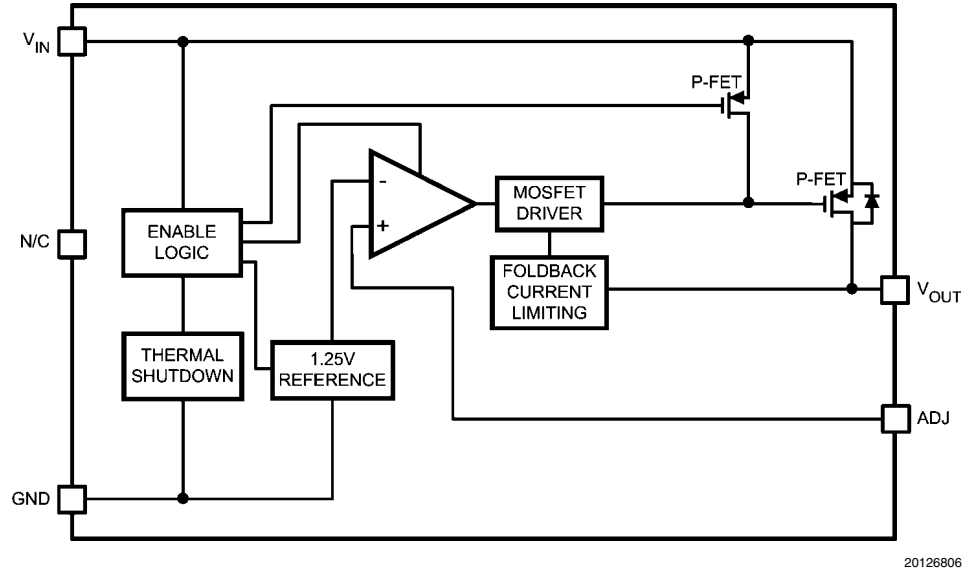

FIGURE 1. LP38691-ADJ Functional Diagram (LLP)

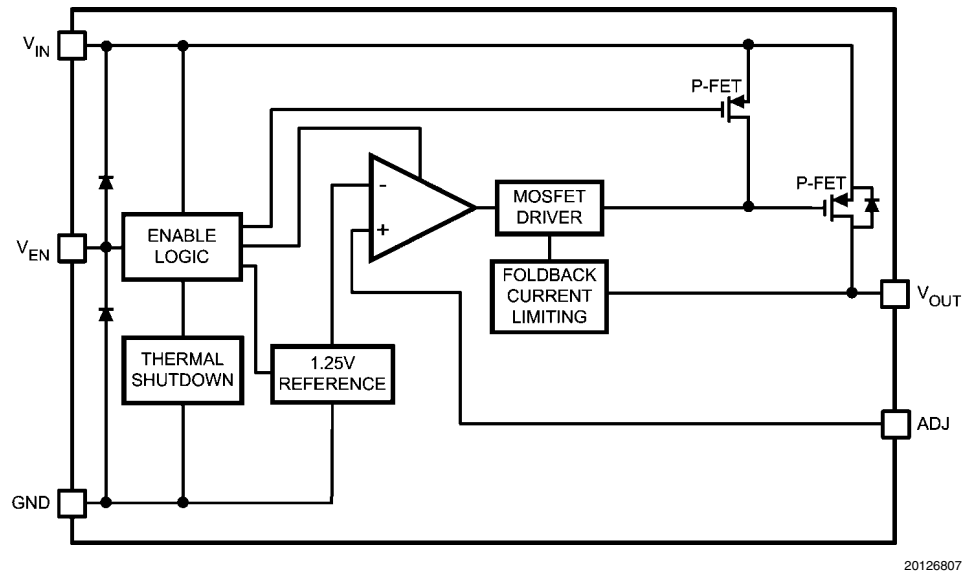
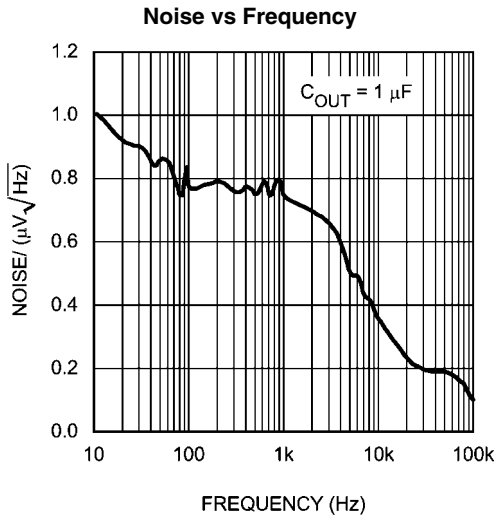

FIGURE 2. LP38693-ADJ Functional Diagram (SOT-223, LLP)

Typical Performance Characteristics

Unless otherwise specified: $T_J = 25^\circ\text{C}$, $C_{IN} = C_{OUT} = 10\ \mu\text{F}$, enable pin is tied to V_{IN} (LP38693-ADJ only), $V_O = 1.25\text{V}$, $V_{IN} = 2.7\text{V}$, $I_L = 10\text{mA}$.



20126835

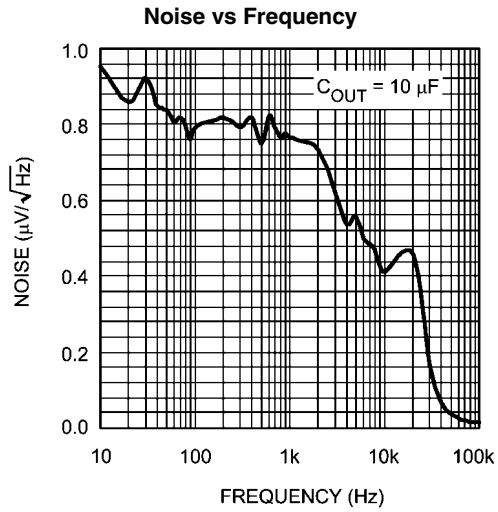

20126836

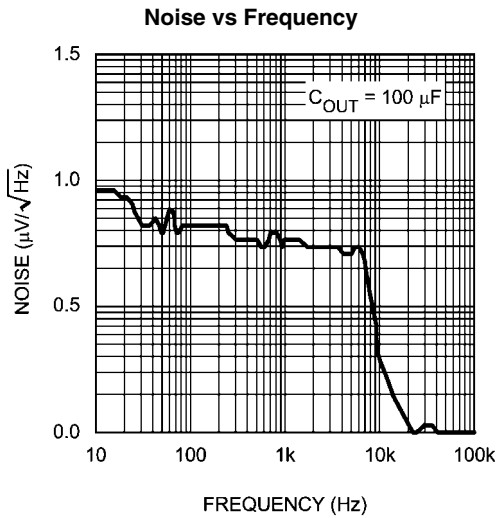

20126837

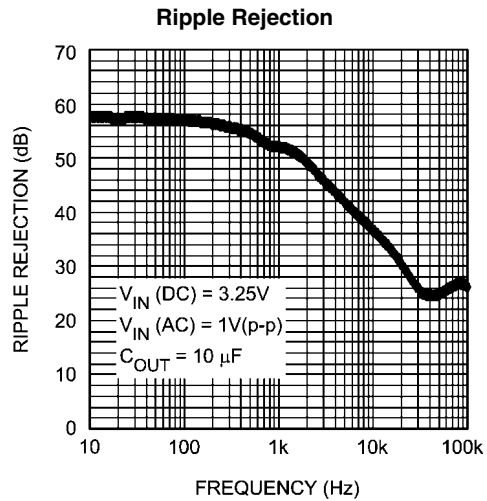

20126817

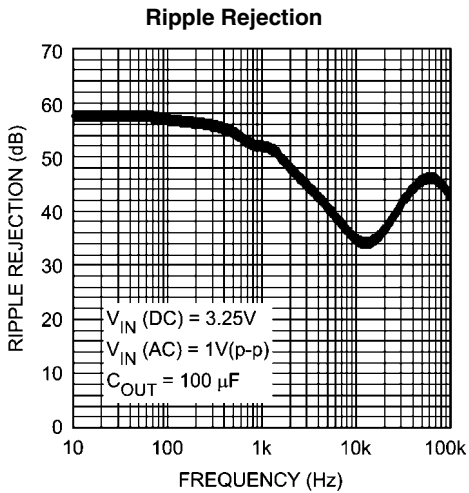

20126819

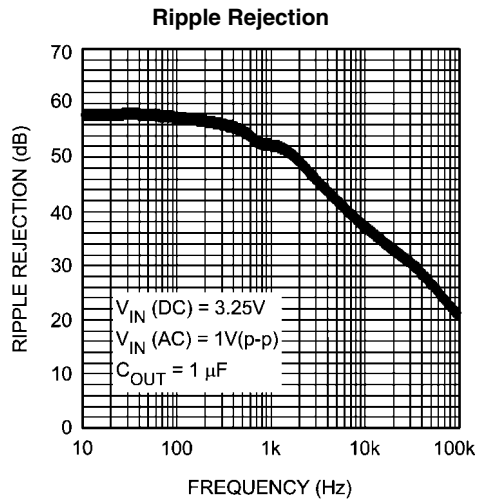

20126821

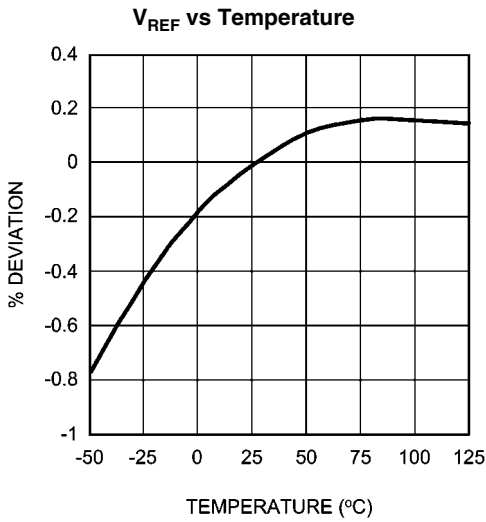

20126830

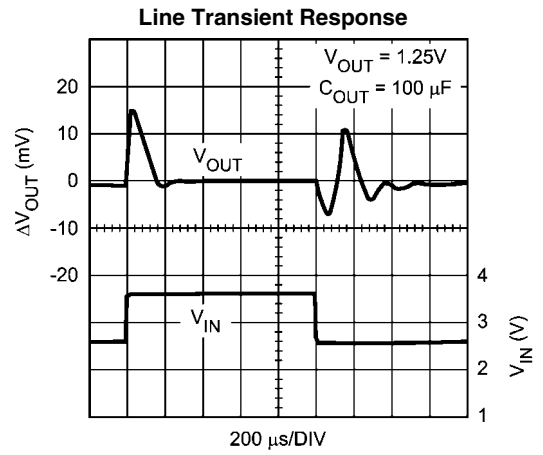

20126823

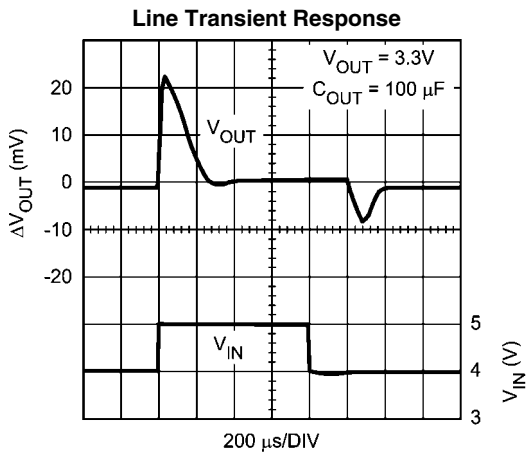

20126824

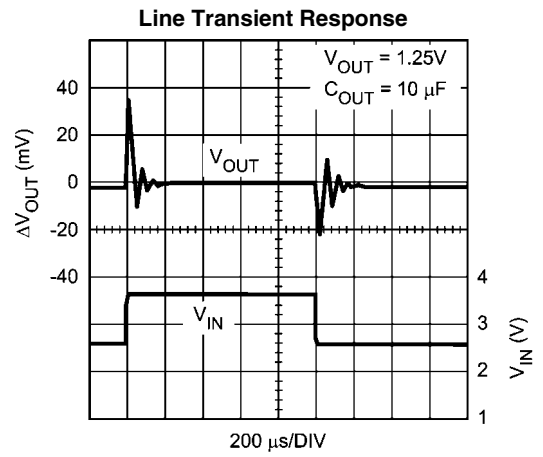

20126825

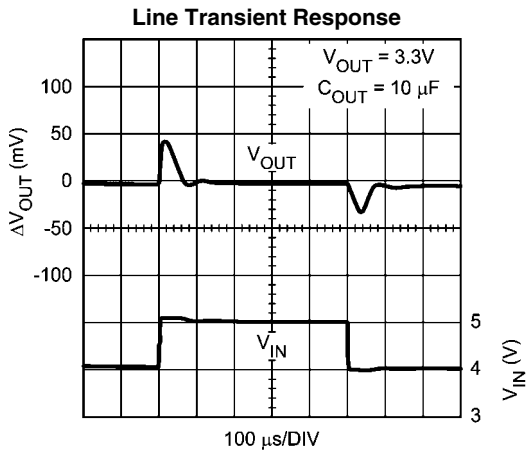

20126826

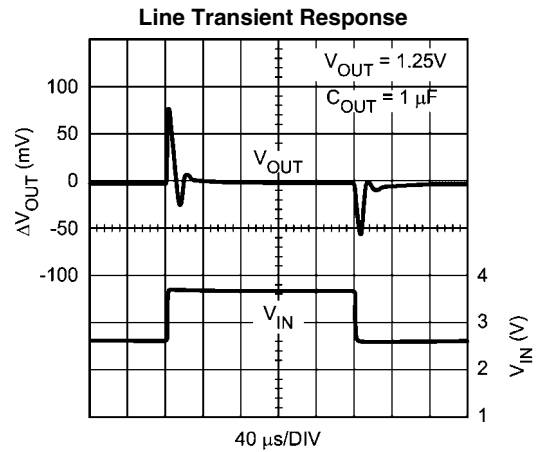

20126827

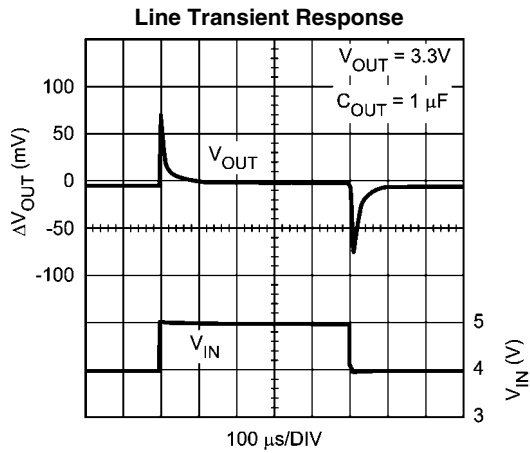

20126828

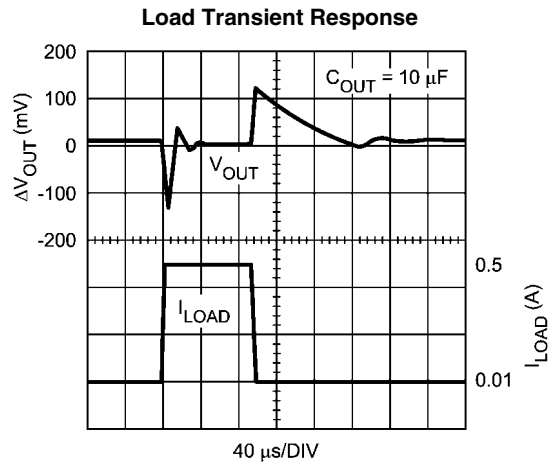

20126842

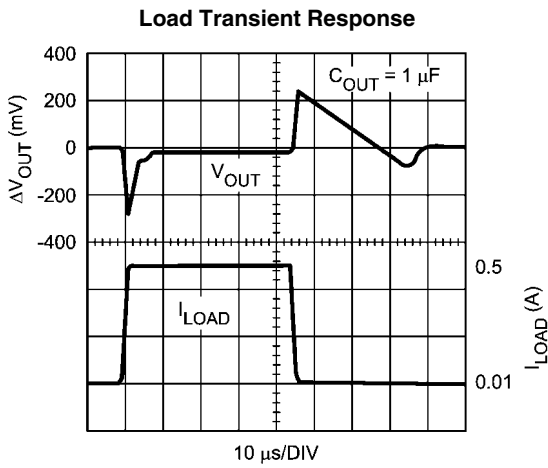

20126844

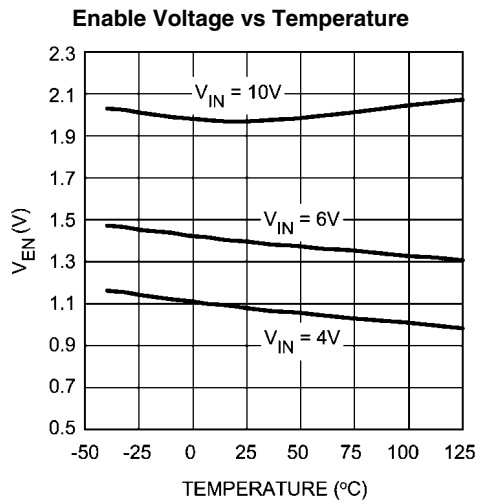

20126853

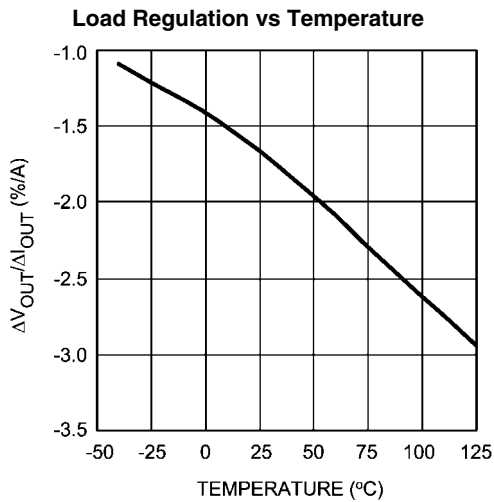

20126854

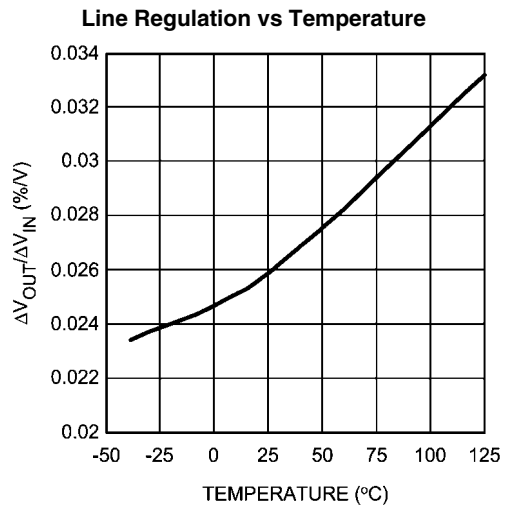

20126855

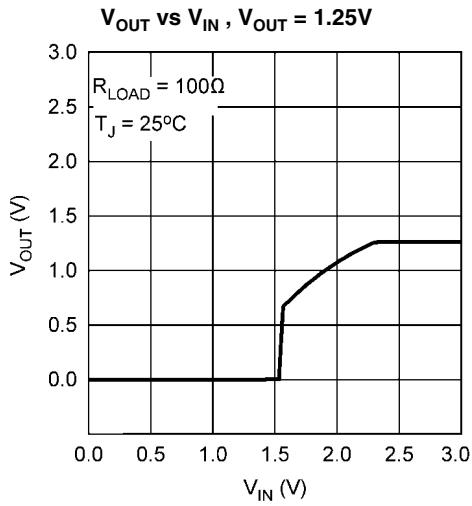

20126858

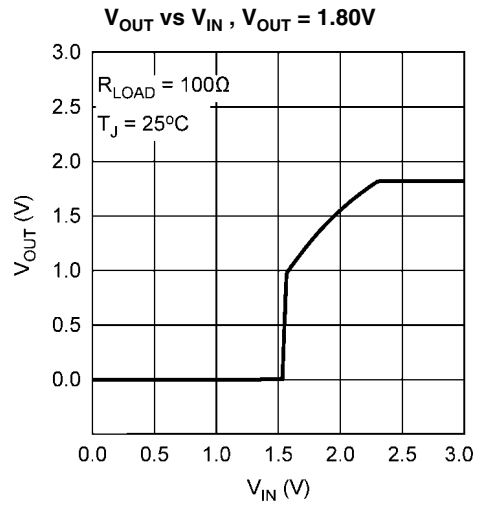

20126859

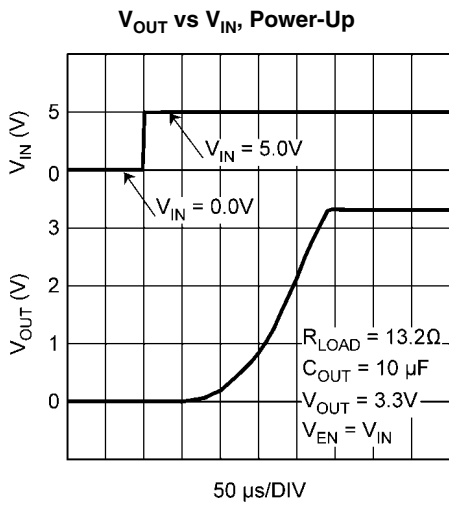

20126860

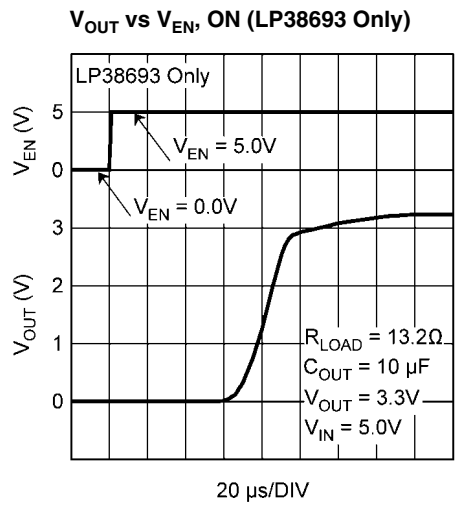

20126861

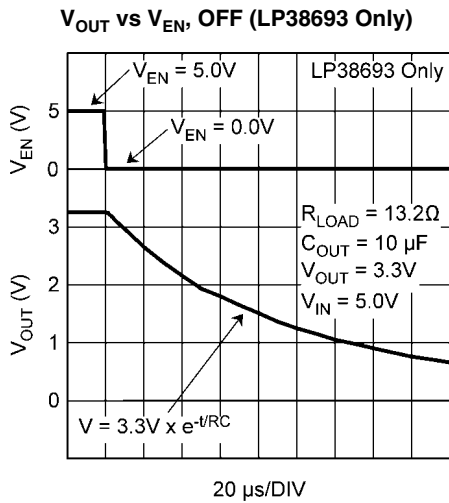

20126862

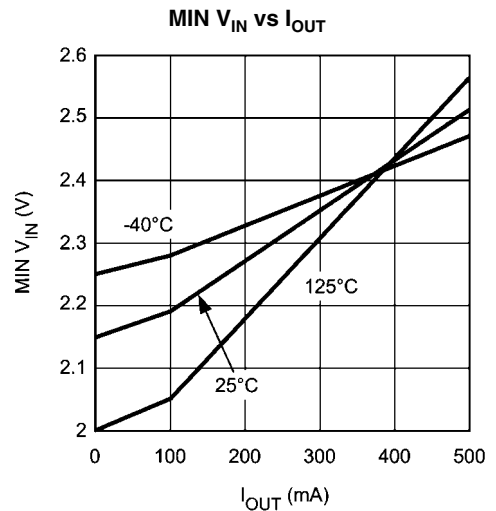

20126856

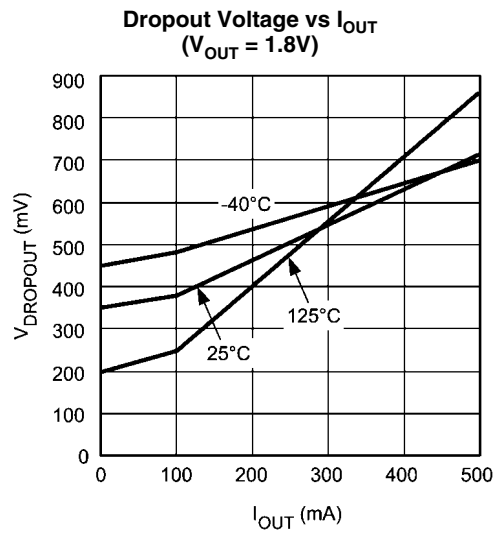

20126857

Application Hints

EXTERNAL CAPACITORS

Like any low-dropout regulator, external capacitors are required to assure stability. These capacitors must be correctly selected for proper performance.

INPUT CAPACITOR: An input capacitor of at least 1µF is required (ceramic recommended). The capacitor must be located not more than one centimeter from the input pin and returned to a clean analog ground.

OUTPUT CAPACITOR: An output capacitor is required for loop stability. It must be located less than 1 centimeter from the device and connected directly to the output and ground pins using traces which have no other currents flowing through them.

The minimum amount of output capacitance that can be used for stable operation is 1µF. Ceramic capacitors are recommended (the LP38691/3-ADJ was designed for use with ultra low ESR capacitors). The LP38691/3-ADJ is stable with any output capacitor ESR between zero and 100 Ohms.

SETTING THE OUTPUT VOLTAGE: The output voltage is set using the external resistors R1 and R2 (see Typical Application Circuit). The output voltage will be given by the equation:

$$V_{OUT} = V_{ADJ} \times (1 + (R1 / R2))$$

Because the part has a minimum load current requirement of 100 µA, it is recommended that R2 always be 12k Ohms or less to provide adequate loading. Even if a minimum load is always provided by other means, it is not recommended that very high value resistors be used for R1 and R2 because it can make the ADJ node susceptible to noise pickup. A maximum Ohmic value of 100k is recommended for R2 to prevent this from occurring.

ENABLE PIN (LP38693-ADJ only): The LP38693-ADJ has an Enable pin (EN) which allows an external control signal to turn the regulator output On and Off. The Enable On/Off threshold has no hysteresis. The voltage signal must rise and fall cleanly, and promptly, through the ON and OFF voltage thresholds. The Enable pin has no internal pull-up or pull-down to establish a default condition and, as a result, this pin must be terminated either actively or passively. If the Enable pin is driven from a source that actively pulls high and low, the drive voltage should not be allowed to go below ground potential or higher than V_{IN} . If the application does not require the Enable function, the pin should be connected directly to the V_{IN} pin.

FOLDBACK CURRENT LIMITING: Foldback current limiting is built into the LP38691/3-ADJ which reduces the amount of output current the part can deliver as the output voltage is reduced. The amount of load current is dependent on the differential voltage between V_{IN} and V_{OUT} . Typically, when this differential voltage exceeds 5V, the load current will limit at about 350 mA. When the $V_{IN} - V_{OUT}$ differential is reduced below 4V, load current is limited to about 850 mA.

SELECTING A CAPACITOR

It is important to note that capacitance tolerance and variation with temperature must be taken into consideration when selecting a capacitor so that the minimum required amount of capacitance is provided over the full operating temperature range.

Capacitor Characteristics

CERAMIC

For values of capacitance in the 10 to 100 µF range, ceramics are usually larger and more costly than tantalums but give superior AC performance for bypassing high frequency noise because of very low ESR (typically less than 10 mΩ). However, some dielectric types do not have good capacitance characteristics as a function of voltage and temperature.

Z5U and Y5V dielectric ceramics have capacitance that drops severely with applied voltage. A typical Z5U or Y5V capacitor can lose 60% of its rated capacitance with half of the rated voltage applied to it. The Z5U and Y5V also exhibit a severe temperature effect, losing more than 50% of nominal capacitance at high and low limits of the temperature range.

X7R and X5R dielectric ceramic capacitors are strongly recommended if ceramics are used, as they typically maintain a capacitance range within ±20% of nominal over full operating ratings of temperature and voltage. Of course, they are typically larger and more costly than Z5U/Y5U types for a given voltage and capacitance.

TANTALUM

Solid Tantalum capacitors have good temperature stability: a high quality Tantalum will typically show a capacitance value that varies less than 10-15% across the full temperature range of -40°C to 125°C. ESR will vary only about 2X going from the high to low temperature limits.

The increasing ESR at lower temperatures can cause oscillations when marginal quality capacitors are used (if the ESR of the capacitor is near the upper limit of the stability range at room temperature).

REVERSE VOLTAGE

A reverse voltage condition will exist when the voltage at the output pin is higher than the voltage at the input pin. Typically this will happen when V_{IN} is abruptly taken low and C_{OUT} continues to hold a sufficient charge such that the input to output voltage becomes reversed. A less common condition is when an alternate voltage source is connected to the output.

There are two possible paths for current to flow from the output pin back to the input during a reverse voltage condition.

1) While V_{IN} is high enough to keep the control circuitry alive, and the Enable pin (LP38693-ADJ only) is above the $V_{EN(ON)}$ threshold, the control circuitry will attempt to regulate the output voltage. If the input voltage is less than the programmed output voltage, the control circuit will drive the gate of the pass element to the full ON condition. In this condition, reverse current will flow from the output pin to the input pin, limited only by the $R_{DS(ON)}$ of the pass element and the output to input voltage differential. Discharging an output capacitor up to 1000 µF in this manner will not damage the device as the current will rapidly decay. However, continuous reverse current should be avoided. When the Enable pin is low this condition will be prevented.

2) The internal PFET pass element has an inherent parasitic diode. During normal operation, the input voltage is higher than the output voltage and the parasitic diode is reverse biased. However, when V_{IN} is below the value where the control circuitry is alive, or the Enable pin is low (LP38693-ADJ only), and the output voltage is more than 500 mV (typical) above the input voltage the parasitic diode becomes forward biased and current flows from the output pin to the input pin through the diode. The current in the parasitic diode should be limited to less than 1A continuous and 5A peak.

If used in a dual-supply system where the regulator output load is returned to a negative supply, the output pin must be diode clamped to ground to limit the negative voltage transition. A Schottky diode is recommended for this protective clamp.

PCB LAYOUT

Good PC layout practices must be used or instability can be induced because of ground loops and voltage drops. The input and output capacitors must be directly connected to the input, output, and ground pins of the regulator using traces which do not have other currents flowing in them (Kelvin connect).

The best way to do this is to lay out C_{IN} and C_{OUT} near the device with short traces to the V_{IN} , V_{OUT} , and ground pins. The regulator ground pin should be connected to the external circuit ground so that the regulator and its capacitors have a "single point ground".

It should be noted that stability problems have been seen in applications where "vias" to an internal ground plane were used at the ground points of the IC and the input and output capacitors. This was caused by varying ground potentials at these nodes resulting from current flowing through the ground plane. Using a single point ground technique for the regulator and its capacitors fixed the problem. Since high current flows through the traces going into V_{IN} and coming from V_{OUT} , Kelvin connect the capacitor leads to these pins so there is no voltage drop in series with the input and output capacitors.

LLP MOUNTING

The SDE06A (No Pullback) 6-Lead LLP package requires specific mounting techniques which are detailed in National Semiconductor Application Note # 1187. Referring to the section **PCB Design Recommendations** in AN-1187 (Page 5), it should be noted that the pad style which should be used with the LLP package is the NSMD (non-solder mask defined) type. Additionally, it is recommended the PCB terminal pads to be 0.2 mm longer than the package pads to create a solder fillet to improve reliability and inspection.

The thermal dissipation of the LLP package is directly related to the printed circuit board construction and the amount of additional copper area connected to the DAP.

The DAP (exposed pad) on the bottom of the LLP package is connected to the die substrate with a conductive die attach adhesive. The DAP has no direct electrical (wire) connection to any of the pins. There is a parasitic PN junction between the die substrate and the device ground. As such, it is strongly recommended that the DAP be connected directly to the ground at device lead 2 (i.e. GND). Alternately, but not recommended, the DAP may be left floating (i.e. no electrical connection). The DAP must not be connected to any potential other than ground.

For the LP38691SD-ADJ and LP38693SD-ADJ in the SDE06A 6-Lead LLP package, the junction-to-case thermal rating, θ_{JC} , is 10.4°C/W, where the case is the bottom of the package at the center of the DAP. The junction-to-ambient thermal performance for the LP38691SD-ADJ and LP38693SD-ADJ in the SDE06A 6-Lead LLP package, using the JEDEC JESD51 standards is summarized in the following table:

Board Type	Thermal Vias	θ_{JC}	θ_{JA}
JEDEC 2-Layer JESD 51-3	None	10.4°C/W	237°C/W
JEDEC 4-Layer JESD 51-7	1	10.4°C/W	74°C/W
	2	10.4°C/W	60°C/W
	4	10.4°C/W	49°C/W
	6	10.4°C/W	45°C/W

RFI/EMI SUSCEPTIBILITY

RFI (radio frequency interference) and EMI (electromagnetic interference) can degrade any integrated circuit's performance because of the small dimensions of the geometries inside the device. In applications where circuit sources are present which generate signals with significant high frequency energy content (> 1 MHz), care must be taken to ensure that this does not affect the IC regulator.

If RFI/EMI noise is present on the input side of the regulator (such as applications where the input source comes from the output of a switching regulator), good ceramic bypass capacitors must be used at the input pin of the IC.

If a load is connected to the IC output which switches at high speed (such as a clock), the high-frequency current pulses required by the load must be supplied by the capacitors on the IC output. Since the bandwidth of the regulator loop is less than 100 kHz, the control circuitry cannot respond to load changes above that frequency. This means the effective output impedance of the IC at frequencies above 100 kHz is determined only by the output capacitor(s).

In applications where the load is switching at high speed, the output of the IC may need RF isolation from the load. It is recommended that some inductance be placed between the output capacitor and the load, and good RF bypass capacitors be placed directly across the load.

PCB layout is also critical in high noise environments, since RFI/EMI is easily radiated directly into PC traces. Noisy circuitry should be isolated from "clean" circuits where possible, and grounded through a separate path. At MHz frequencies, ground planes begin to look inductive and RFI/EMI can cause ground bounce across the ground plane. In multi-layer PCB applications, care should be taken in layout so that noisy power and ground planes do not radiate directly into adjacent layers which carry analog power and ground.

OUTPUT NOISE

Noise is specified in two ways- **Spot Noise** or **Output Noise** density is the RMS sum of all noise sources, measured at the regulator output, at a specific frequency (measured with a 1Hz bandwidth). This type of noise is usually plotted on a curve as a function of frequency. **Total Output Noise** or **Broad-Band Noise** is the RMS sum of spot noise over a specified bandwidth, usually several decades of frequencies.

Attention should be paid to the units of measurement. Spot noise is measured in units $\mu\text{V}/\sqrt{\text{Hz}}$ or $\text{nV}/\sqrt{\text{Hz}}$ and total output noise is measured in $\mu\text{V}(\text{rms})$

The primary source of noise in low-dropout regulators is the internal reference. Noise can be reduced in two ways: by increasing the transistor area or by increasing the current drawn by the internal reference. Increasing the area will decrease the chance of fitting the die into a smaller package. Increasing the current drawn by the internal reference increases the total supply current (ground pin current).

Physical Dimensions inches (millimeters) unless otherwise noted

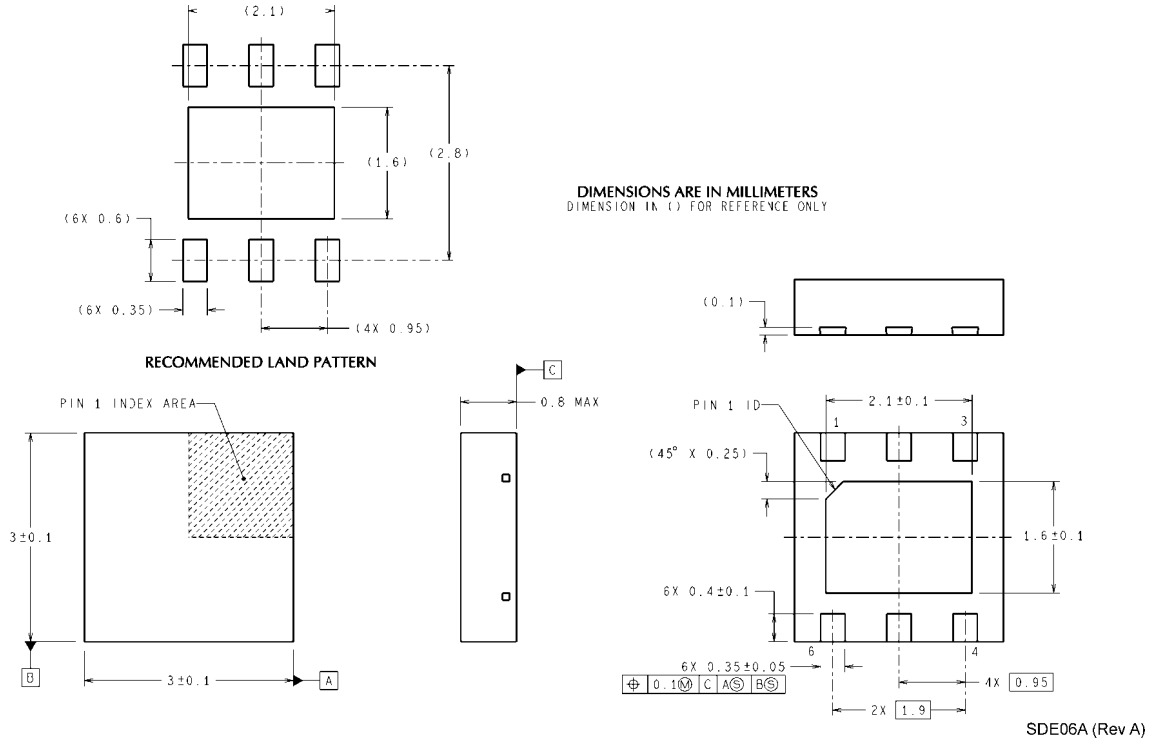

6-lead, LLP Package
NS Package Number SDE06A

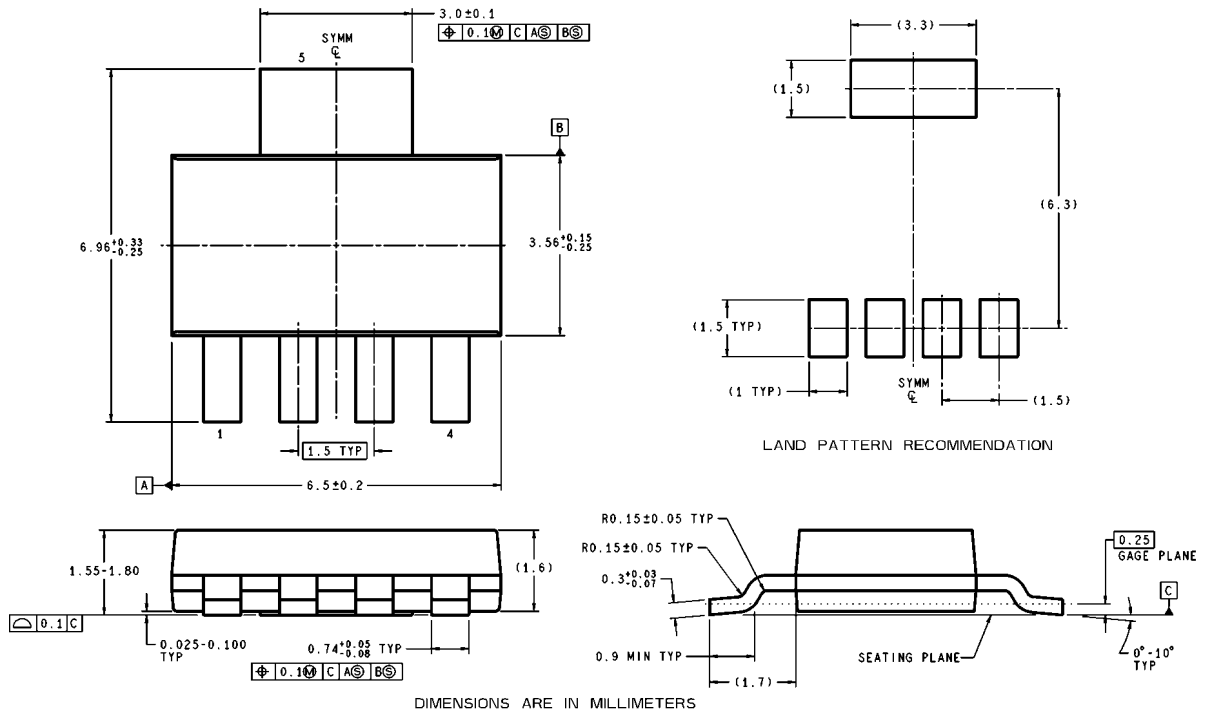

SOT-223 Package
NS Package Number MP05A

Notes

LP38691-ADJ/LP38693-ADJ

Notes

For more National Semiconductor product information and proven design tools, visit the following Web sites at:
www.national.com

Products		Design Support	
Amplifiers	www.national.com/amplifiers	WEBENCH® Tools	www.national.com/webench
Audio	www.national.com/audio	App Notes	www.national.com/appnotes
Clock and Timing	www.national.com/timing	Reference Designs	www.national.com/refdesigns
Data Converters	www.national.com/adc	Samples	www.national.com/samples
Interface	www.national.com/interface	Eval Boards	www.national.com/evalboards
LVDS	www.national.com/lvds	Packaging	www.national.com/packaging
Power Management	www.national.com/power	Green Compliance	www.national.com/quality/green
Switching Regulators	www.national.com/switchers	Distributors	www.national.com/contacts
LDOs	www.national.com/ldo	Quality and Reliability	www.national.com/quality
LED Lighting	www.national.com/led	Feedback/Support	www.national.com/feedback
Voltage References	www.national.com/vref	Design Made Easy	www.national.com/easy
PowerWise® Solutions	www.national.com/powerwise	Applications & Markets	www.national.com/solutions
Serial Digital Interface (SDI)	www.national.com/sdi	Mil/Aero	www.national.com/milaero
Temperature Sensors	www.national.com/tempensors	SolarMagic™	www.national.com/solarmagic
PLL/VCO	www.national.com/wireless	PowerWise® Design University	www.national.com/training

THE CONTENTS OF THIS DOCUMENT ARE PROVIDED IN CONNECTION WITH NATIONAL SEMICONDUCTOR CORPORATION ("NATIONAL") PRODUCTS. NATIONAL MAKES NO REPRESENTATIONS OR WARRANTIES WITH RESPECT TO THE ACCURACY OR COMPLETENESS OF THE CONTENTS OF THIS PUBLICATION AND RESERVES THE RIGHT TO MAKE CHANGES TO SPECIFICATIONS AND PRODUCT DESCRIPTIONS AT ANY TIME WITHOUT NOTICE. NO LICENSE, WHETHER EXPRESS, IMPLIED, ARISING BY ESTOPPEL OR OTHERWISE, TO ANY INTELLECTUAL PROPERTY RIGHTS IS GRANTED BY THIS DOCUMENT.

TESTING AND OTHER QUALITY CONTROLS ARE USED TO THE EXTENT NATIONAL DEEMS NECESSARY TO SUPPORT NATIONAL'S PRODUCT WARRANTY. EXCEPT WHERE MANDATED BY GOVERNMENT REQUIREMENTS, TESTING OF ALL PARAMETERS OF EACH PRODUCT IS NOT NECESSARILY PERFORMED. NATIONAL ASSUMES NO LIABILITY FOR APPLICATIONS ASSISTANCE OR BUYER PRODUCT DESIGN. BUYERS ARE RESPONSIBLE FOR THEIR PRODUCTS AND APPLICATIONS USING NATIONAL COMPONENTS. PRIOR TO USING OR DISTRIBUTING ANY PRODUCTS THAT INCLUDE NATIONAL COMPONENTS, BUYERS SHOULD PROVIDE ADEQUATE DESIGN, TESTING AND OPERATING SAFEGUARDS.

EXCEPT AS PROVIDED IN NATIONAL'S TERMS AND CONDITIONS OF SALE FOR SUCH PRODUCTS, NATIONAL ASSUMES NO LIABILITY WHATSOEVER, AND NATIONAL DISCLAIMS ANY EXPRESS OR IMPLIED WARRANTY RELATING TO THE SALE AND/OR USE OF NATIONAL PRODUCTS INCLUDING LIABILITY OR WARRANTIES RELATING TO FITNESS FOR A PARTICULAR PURPOSE, MERCHANTABILITY, OR INFRINGEMENT OF ANY PATENT, COPYRIGHT OR OTHER INTELLECTUAL PROPERTY RIGHT.

LIFE SUPPORT POLICY

NATIONAL'S PRODUCTS ARE NOT AUTHORIZED FOR USE AS CRITICAL COMPONENTS IN LIFE SUPPORT DEVICES OR SYSTEMS WITHOUT THE EXPRESS PRIOR WRITTEN APPROVAL OF THE CHIEF EXECUTIVE OFFICER AND GENERAL COUNSEL OF NATIONAL SEMICONDUCTOR CORPORATION. As used herein:

Life support devices or systems are devices which (a) are intended for surgical implant into the body, or (b) support or sustain life and whose failure to perform when properly used in accordance with instructions for use provided in the labeling can be reasonably expected to result in a significant injury to the user. A critical component is any component in a life support device or system whose failure to perform can be reasonably expected to cause the failure of the life support device or system or to affect its safety or effectiveness.

National Semiconductor and the National Semiconductor logo are registered trademarks of National Semiconductor Corporation. All other brand or product names may be trademarks or registered trademarks of their respective holders.

Copyright© 2010 National Semiconductor Corporation

For the most current product information visit us at www.national.com



National Semiconductor Americas Technical Support Center
 Email: support@nsc.com
 Tel: 1-800-272-9959

National Semiconductor Europe Technical Support Center
 Email: europe.support@nsc.com

National Semiconductor Asia Pacific Technical Support Center
 Email: ap.support@nsc.com

National Semiconductor Japan Technical Support Center
 Email: jpn.feedback@nsc.com