

<b>Title</b>	<b><i>Reference Design Report for 3 W Non-Isolated Constant Current LED Driver Using LNK306DN</i></b>
<b>Specification</b>	85–265 VAC Input, 10 V, 300 mA Output
<b>Application</b>	LED Lighting / Bulb Retrofit
<b>Author</b>	Power Integrations Applications Department
<b>Document Number</b>	RDR-131
<b>Date</b>	March 7, 2007
<b>Revision</b>	1.1

### **Summary and Features**

- Extremely small form factor, fits within GU10 lamp base
- Operates over the universal input voltage range (85 – 265 VAC)
- Meets EN55022 B conducted EMI requirements
- Drives LEDs in constant current (CC) mode
- Built-in, output overvoltage protection when unloaded
  - Allows supply to be tested without the load connected
- Low parts count, low-cost solution: only 25 components
- Non-isolated buck converter configuration allows use of off-the-shelf inductors (does not require a custom transformer)

The products and applications illustrated herein (including circuits external to the products and transformer construction) may be covered by one or more U.S. and foreign patents or potentially by pending U.S. and foreign patent applications assigned to Power Integrations. A complete list of Power Integrations' patents may be found at [www.powerint.com](http://www.powerint.com).

## Table of Contents

1	Introduction.....	3
2	Power Supply Specification .....	5
3	Circuit Diagram.....	6
4	Circuit Description .....	7
4.1	Configuration and Assembly Details.....	7
4.2	AC Input Rectification.....	7
4.3	LinkSwitch-TN .....	7
4.4	Output Feedback.....	7
5	Bill of Materials .....	10
5.1	Filter Board Bill of Materials.....	10
5.2	Converter Board Bill of Materials.....	11
6	PI XIs Design Spreadsheet.....	12
7	Performance.....	14
7.1	Efficiency.....	14
7.2	Output Current Regulation Vs. Line Voltage.....	15
7.3	Output VI Characteristic .....	15
8	Waveforms .....	16
8.1	Drain Voltage and Current, Normal Operation.....	16
8.2	Output Current and Voltage.....	16
8.3	Drain Current and Bulk Capacitor Voltage.....	17
8.4	Startup Drain Current and Bulk Capacitor Voltage .....	17
8.5	Startup Output Voltage and Current.....	18
8.6	Fault Conditions .....	18
9	Thermal Measurements.....	19
10	Conducted EMI.....	20
10.1	Competitive Product EMI.....	21
11	Revision History.....	22

### Important Note:

This board has no safety isolation. Therefore, all testing should be performed using an isolation transformer to provide the AC input to the prototype board.

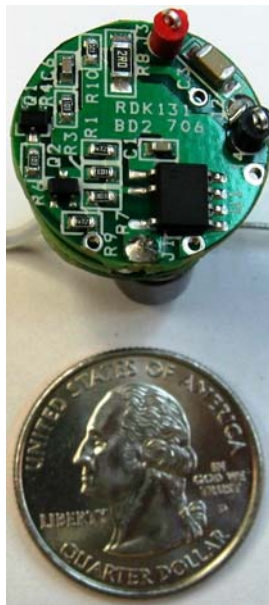


## 1 Introduction

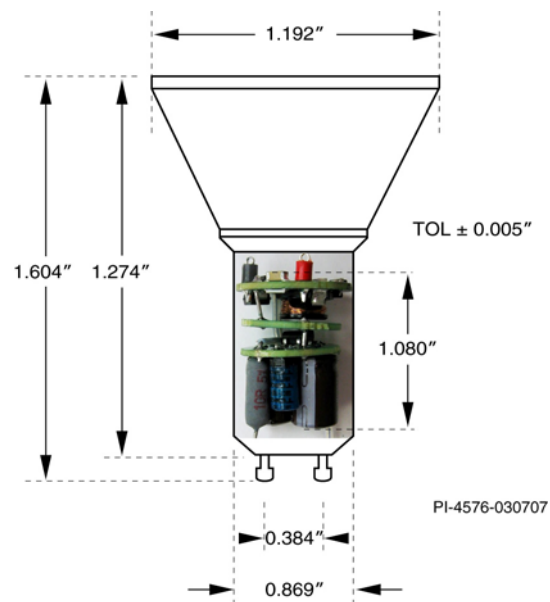
This engineering report describes an LED driver power supply that uses a member of the LinkSwitch-TN family of devices, the LNK306DN. The circuit regulates its load current to 300 mA while developing about 10 V across three series HB-LEDs.

The design provides no safety isolation between the AC input and DC output. Therefore the enclosure must be designed to provide isolation.

The report contains the power supply specification, a circuit diagram, a complete bill of materials, the *PI Xls* spreadsheet results for the design, the printed circuit board layouts, and performance data.



**Figure 1** – Photographs of (Top and Side views) Populated Circuit Board Assembly.



**Figure 2** – Mechanical Positioning of the Power Supply Assembly Inside the GU10 Bulb Socket Base.



## 2 Power Supply Specification

Description	Symbol	Min	Typ	Max	Units	Comment
<b>Input</b>						
Voltage	$V_{IN}$	85		265	VAC	2 Wire – no P.E.
Frequency	$f_{LINE}$	47	50/60	64	Hz	
No-load Input Power (230 VAC)				-	W	Not applicable
<b>Output</b>						
Output Voltage 1	$V_{OUT1}$		10		V	± 10% at 25 °C
Output Current 1	$I_{OUT1}$		0.3		A	
<b>Total Output Power</b>						
Continuous Output Power	$P_{OUT}$			3	W	
<b>Efficiency</b>	$\eta$		62		%	Measured at $P_{OUT}$ (3 W), 25 °C
<b>Environmental</b>						
Conducted EMI			Meets EN55022B/CISPR22B			
Safety			No input to output isolation			
Ambient Temperature	$T_{AMB}$	0		40	°C	Free convection, sea level



### 3 Circuit Diagram

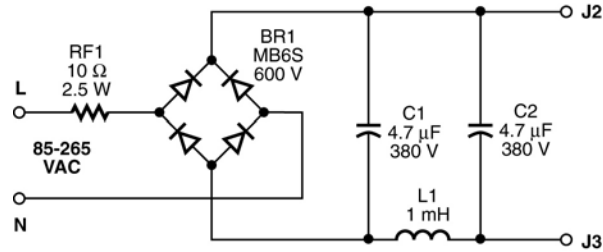


Figure 3a – Circuit Diagram of Filter Board.

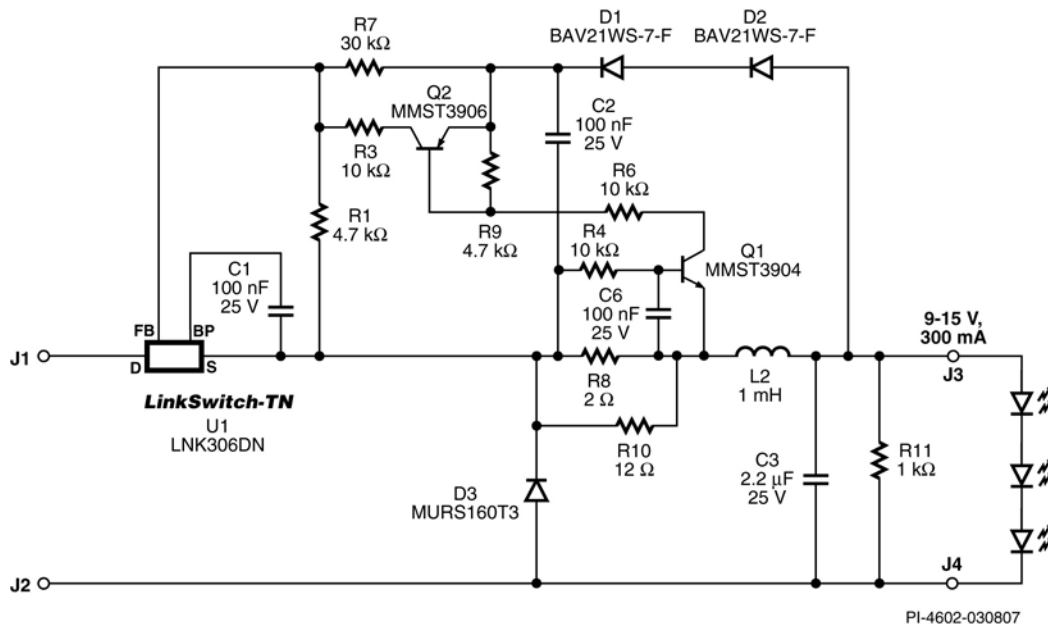


Figure 3b – Circuit Diagram of Converter Board.



## 4 Circuit Description

### 4.1 Configuration and Assembly Details

The power supply is configured as a non-isolated buck converter. Since it must fit in a GU10 lamp socket base, the supply was split into 2 interconnected boards. A Faraday shield (the third board) was sandwiched between the input rectification/EMI filter (bottom) board and the converter (top) board. The shield board is electrically connected to the converter board. This was necessary to meet the conducted EMI requirements. The shield consists of a single-sided, copper-clad PCB that is the same size as the input rectification/EMI filter board.

### 4.2 AC Input Rectification

A 10  $\Omega$  fusible resistor (RF1) will act as a fuse if a catastrophic failure occurs. The input voltage and current are rectified by a bridge rectifier (BR1) and smoothed by a pi filter circuit (C1, L1 and C2). The pi filter and RF1 also help attenuate the differential mode conducted EMI that is generated by the switching of the buck converter.

### 4.3 LinkSwitch-TN

The *PI Xls* spreadsheet tool was used to design this converter. When powering the designated LED load, the converter operates in the continuous conduction mode (CCM). The buck converter stage consists of the integrated MOSFET switch within the LNK306DN (U1), a freewheeling diode (D3), an output inductor (L2) and an output capacitor (C3). An Ultrafast MURS160T3 was chosen for the freewheeling diode to minimize the amplitude of the MOSFET turn-on spike. The remaining components are involved in sensing the normal-load output current and the no-load output voltage and conveying that information back to the FEEDBACK (FB) pin of the LNK306DN.

### 4.4 Output Feedback

The LinkSwitch-TN uses On/Off control to regulate the output of the supply. During each enabled switching cycle the drain current ramps to a fixed internal current limit level. When current into the FEEDBACK (FB) pin exceeds 49  $\mu$ A the next switching is disabled. By adjusting the number of enabled to disabled cycles the amount of energy delivered to the output can be varied to maintain regulation. The 49  $\mu$ A threshold is specified at a FB pin voltage of 1.65 V allowing this pin to be used as a voltage reference.

In this design both current and voltage feedback is used. Current feedback limits the LED current during normal operation while voltage feedback limits the output voltage should the LED load be disconnected, for example during production testing.

During the off time of U1, the voltage that appears across C2 is equal to the output voltage less a diode drop. In this design two 250 V rated diodes, D1 and D2, were used for space reasons, however a single 600 V diode could be used (in this case the voltage across C2 would be equal to the output voltage).



This voltage is divided by R7 and R1 so the voltage at the FB pin is 1.65 V when the output voltage reaches ~12 V. Due to the interaction with the current sense circuit and the small output capacitor value the actual peak no-load voltage is limited to ~18 V.

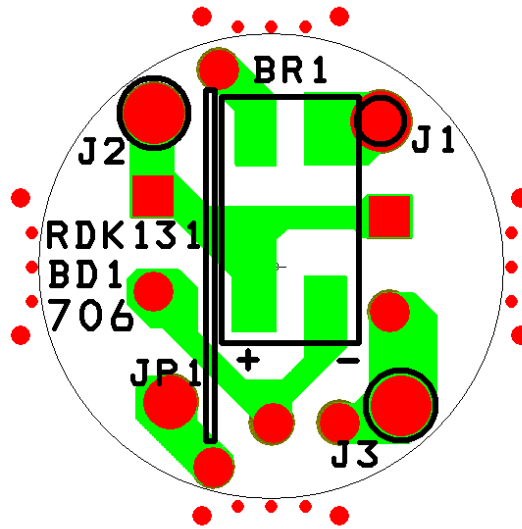
Current feedback is provided by sensing the voltage drop across R8 and R10, which is filtered by R4 and C6. Once the voltage drop exceeds the VBE of Q1, both Q1 and Q2 turn on, feeding additional current into the FB pin of U1 from C2. By adjusting the ratio of enabled to disabled cycles the average output current is controlled. As the VBE of Q1 varies with temperature the circuit exhibits a negative output current temperature coefficient.

Resistor R11 provides a minimum load to ensure correct operation at zero load.

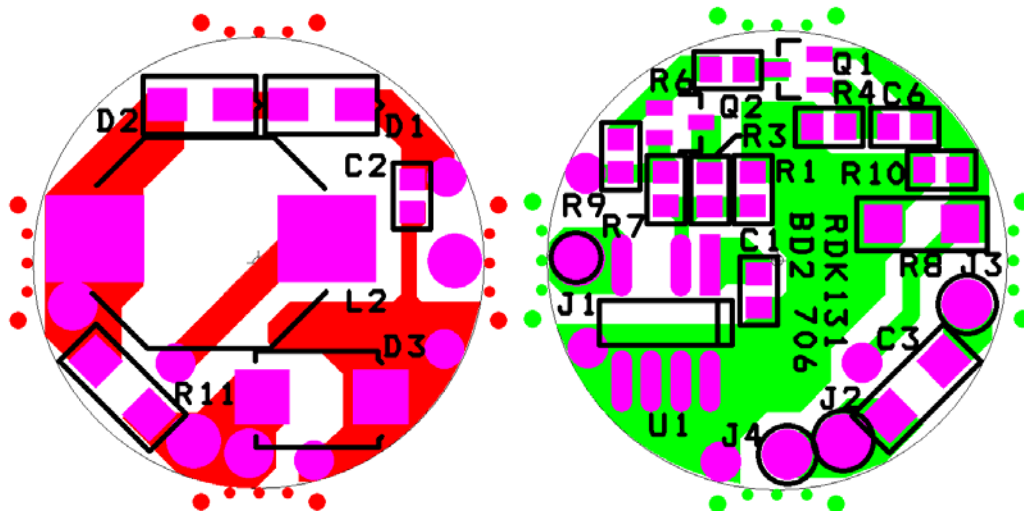
This relatively complicated current sense can be simplified by using the FB pin directly to sense the voltage drop across the sense resistors. However as the FB pin has a voltage of 1.65 V this resulted in unacceptable dissipation ( $0.3 \text{ A} \times 1.65 \text{ V} = 0.5 \text{ W}$ ) inside the GU10 enclosure. However in less thermally challenging designs this approach may be used.







Filter Board



Converter Board (Bottom and Top Side)

Figure 4 – Printed Circuit Board Layouts.



## 5 Bill of Materials

The BOM for each board is presented separately.

### 5.1 Filter Board Bill of Materials

Item	Qty	Ref Des	Value	Description	Mfg Part Number	Mfg	Comment
1	1	BR1	MB6S	600 V, 0.5 A, Bridge Rectifier, SMD, TO-269AA	MB6S	Vishay	
2	2	C1 C2	4.7 $\mu$ F	4.7 $\mu$ F, 380 V, Electrolytic, (8 x 11.5)	XX380VB4R7M8 X11LL	Nippon Chemi-Con	
3	3	J1 J2 J3	PCB Terminal 22 AWG	PCB Terminal Hole, 22 AWG	N/A	N/A	
4	0.08 Ft.	JP1		Wire Jumper, Non-insulated, 22 AWG, 0.6 in	298	Alpha	
5	1	L1	1000 $\mu$ H	1000 $\mu$ H, 0.21 A, 5.5 x 10.5 mm	SBC1-102-211	Tokin	
6	1	RF1	10 $\Omega$	10 $\Omega$ , 2.5 W, Fusible/Flame Proof Wire Wound	CRF253-4 10R	Vitrohm	
7	0.17 Ft.	W1		Wire Jumper, Non-insulated, 22 AWG	298	Alpha	Solder wire in J1 Location (apply teflon tubing (SW1) over wire)
8	0.07 Ft.	W2		Wire Jumper, Non-insulated, 22 AWG	298	Alpha	Solder wire in J2 location (apply teflon tubing (SW2) over wire)
9	0.03 Ft.	W3		Wire Jumper, Non-insulated, 22 AWG	298	Alpha	Solder wire in J3 location (teflon tubing not required)
10	0.07 Ft.	SJP1		Teflon Tubing for 22 AWG wire	TFT-200-22	Alpha	Place over JP1
11	0.15 Ft.	SW1		Teflon Tubing for 22 AWG wire	TFT-200-22	Alpha	Place over W1
12	0.06 Ft.	SW2		Teflon Tubing for 22 AWG wire	TFT-200-22	Alpha	Place over W2



## 5.2 Converter Board Bill of Materials

Item	Qty	Ref Des	Value	Description	Mfg Part Number	Mfg	Comment
1	3	C1 C2 C6	100 nF	100 nF 25 V, Ceramic, X7R, 0603	ECJ-1VB1E104K	Panasonic	
2	1	C3	2.2 $\mu$ F	2.2 $\mu$ F, 25 V, Ceramic, X7R, 1206	ECJ-3YB1E225K	Panasonic	
3	2	D1 D2	BAV21WS-7-F	250 V, 0.2 A, Fast Switching, 50 ns, SOD-323	BAV21WS-7-F	Diode Inc.	
4	1	D3	MURS160T3	600 V, 1 A, Ultrafast Recovery, 35 ns, SMB Case	MURS160T3G	On Semi	
5	2	J1 J2	PCB Terminal 22 AWG	PCB Terminal Hole, 22 AWG	N/A	N/A	
6	1	L2	1000 $\mu$ H	1000 $\mu$ H, 0.3 A	L03316-102-RM	ICE Components	
7	1	Q1	MMST3904	NPN, Small Signal BJT, 40 V, 0.2 A, SOT-323	MMST3904-7-F	Diodes Inc	
8	1	Q2	MMST3906	PNP, Small Signal BJT, 40 V, 0.2 A, SOT-323	MMST3906-7	Diodes Inc	
9	2	R1 R9	4.7 k $\Omega$	4.7 k $\Omega$ , 5%, 1/10 W, Metal Film, 0603	ERJ-3GEYJ472V	Panasonic	
10	3	R3 R4 R6	10 k $\Omega$	10 k $\Omega$ , 5%, 1/10 W, Metal Film, 0603	ERJ-3GEYJ103V	Panasonic	
11	1	R7	30 k $\Omega$	30 k $\Omega$ , 5%, 1/10 W, Metal Film, 0603	ERJ-3GEYJ303V	Panasonic	
12	1	R8	2 $\Omega$	2 $\Omega$ , 5%, 1/4 W, Metal Film, 1206	ERJ-8GEYJ2R0V	Panasonic	
13	1	R10	12 $\Omega$	12 $\Omega$ , 5%, 1/10 W, Metal Film, 0603	ERJ-3GEYJ120V	Panasonic	
14	1	R11	1 k $\Omega$	1 k $\Omega$ , 5%, 1/4 W, Metal Film, 1206	ERJ-8GEYJ102V	Panasonic	
15	1	U1	LNK306D	LinkSwitch-TN, LNK306D, SO-8	LNK306D	Power Integrations	
16	0.17 Ft.	W2		Wire jumper, non insulated, 22 AWG	298	Alpha	Solder wire in J2 Location (teflon tubing is not required)
17	1	J3	CON1	Test Point, RED, Miniature THRU-HOLE MOUNT	5000	Keystone	
18	1	J4	CON1	Test Point, BLK, Miniature THRU-HOLE MOUNT	5001	Keystone	



## 6 PI Xls Design Spreadsheet

ACDC_LinkSwitch-TN_030906; Rev.2.2; Copyright Power Integrations 2006	INPUT	INFO	OUTPUT	UNIT	LinkSwitch-TN_Rev_2-2.xls: LinkSwitch-TN Design Spreadsheet
<b>INPUT VARIABLES</b>					
VACMIN	85			Volts	Minimum AC Input Voltage
VACMAX	265			Volts	Maximum AC Input Voltage
FL	50			Hertz	Line Frequency
VO	12.00			Volts	Output Voltage
IO	0.330			Amps	Output Current
EFFICIENCY (User Estimate)	0.72				Overall Efficiency Estimate (Adjust to match Calculated, or enter Measured Efficiency)
EFFICIENCY (Calculated Estimate)			0.78		Calculated % Efficiency Estimate
CIN	9.40		9.40	uF	Input Filter Capacitor
Input Stage Resistance			0.00	ohms	Input Stage Resistance, Fuse & Filtering
Ambient Temperature			50	deg C	Operating Ambient Temperature (deg Celsius)
Switching Topology			Buck		Type of Switching topology
Input Rectification Type	F		F		Choose H for Half Wave Rectifier and F for Full Wave Rectification

<b>DC INPUT VARIABLES</b>					
VMIN			79.1	Volts	Minimum DC Bus Voltage
VMAX			374.8	Volts	Maximum DC Bus Voltage

<b>LinkSwitch-TN</b>					
LinkSwitch-TN	Auto		LNK306		Selected LinkSwitch-TN
ILIMIT			0.482	Amps	Typical Current Limit
ILIMIT_MIN			0.450	Amps	Minimum Current Limit
ILIMIT_MAX			0.515	Amps	Maximum Current Limit
FSMIN			62000	Hertz	Minimum Switching Frequency
VDS			6.2	Volts	Maximum On-State Drain To Source Voltage drop
PLOSS_LNK			0.51	Watts	Estimated LinkSwitch-TN losses

<b>DIODE</b>					
VD			0.70	Volts	Freewheeling Diode Forward Voltage Drop
VRR			600	Volts	Recommended PIV rating of Freewheeling Diode
IF			1	Amps	Recommended Diode Continuous Current Rating
TRR			35	ns	Recommended Reverse Recovery Time
Diode Recommendation			BYV26C		Suggested Freewheeling Diode

<b>OUTPUT INDUCTOR</b>					
L_TYP			941.6	uH	Required value of Inductance to deliver Output Power (Includes device and inductor tolerances) Choose next higher standard available value
L			1000	uH	<b>Output Inductor, Recommended Standard Value</b>
L_R			2.0	Ohm	DC Resistance of Inductor
<b>OPERATING MODE</b>					
KL_TOL			1.15		<b>CCM</b> Continuous Conduction Mode (at VMIN) Inductor tolerance Factor. Accounts for basic (10% - 20%) Manufacturing Tolerances 1.1 < KL_TOL < 1.2 See AN-37 for detailed explanation
K_LOSS			0.813		Loss factor. Accounts for "off-state" power loss to be supplied by inductor Calculated efficiency < K_LOSS < 1. See AN-37 for detailed explanation
ILRMS			0.33	Amps	Estimated RMS inductor current (at VMAX)



**OUTPUT CAPACITOR**

DELTA_V		0.12	Volts	Target Output Voltage Ripple
MAX_ESR		467	m-Ohm	Maximum Capacitor ESR (milli-Ohms)
I_RIPPLE		0.26	Amps	Output Capacitor Ripple current

**FEEDBACK COMPONENTS**

RBIAS		2.00	k-Ohm	Bias Resistor. Use closest standard 1% value
RFB		11.86	k-Ohm	Feedback Resistor. Use closest standard 1% value
CFB		10	uF	Feedback Capacitor
C_SOFT_START		39092	uF	If the output Voltage is greater than 12 V, or total output and system capacitance is greater than 100 uF, a soft start capacitor between 1uF and 10 uF is recommended. See AN-37 for details

**Note:** The feedback components in the spreadsheet were not used on the power supply because a higher impedance was required by the CC feedback circuit.



## 7 Performance

### 7.1 Efficiency

Efficiency measured at different line voltages are collected in the table below.

VAC IN	Efficiency
85	0.642
115	0.639
220	0.588
265	0.562

Table 1: Efficiency data measured at different AC input line voltages.

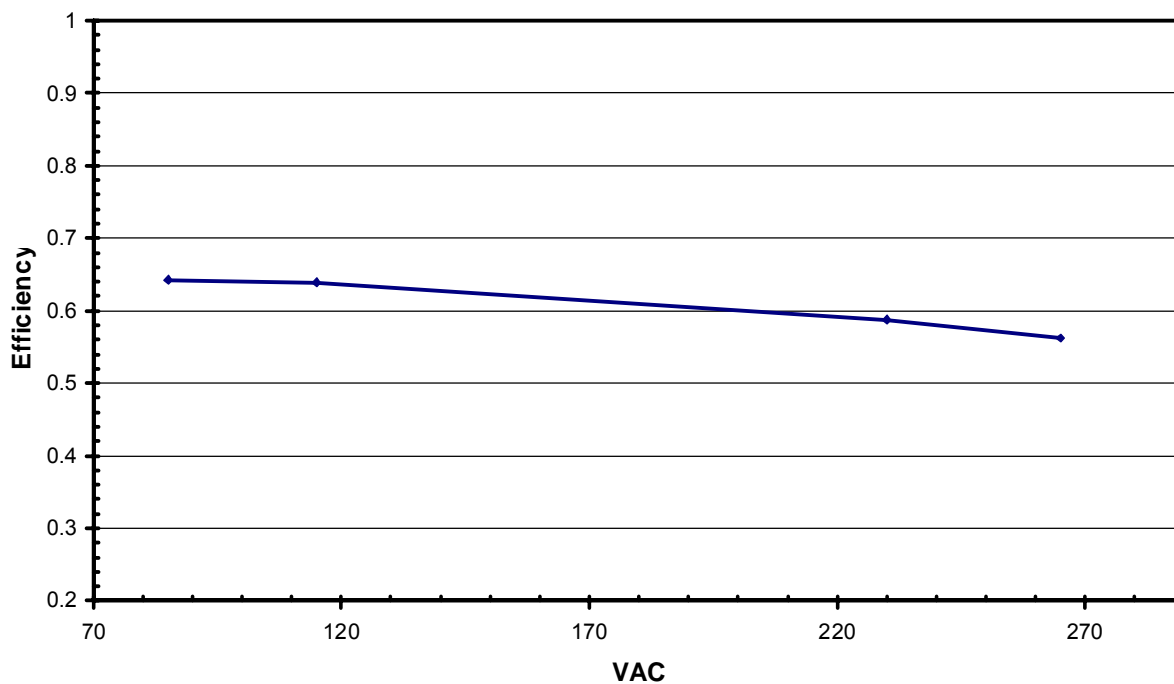


Figure 5 – Efficiency vs. Input Voltage, Room Temperature.



**7.2 Output Current Regulation Vs. Line Voltage**

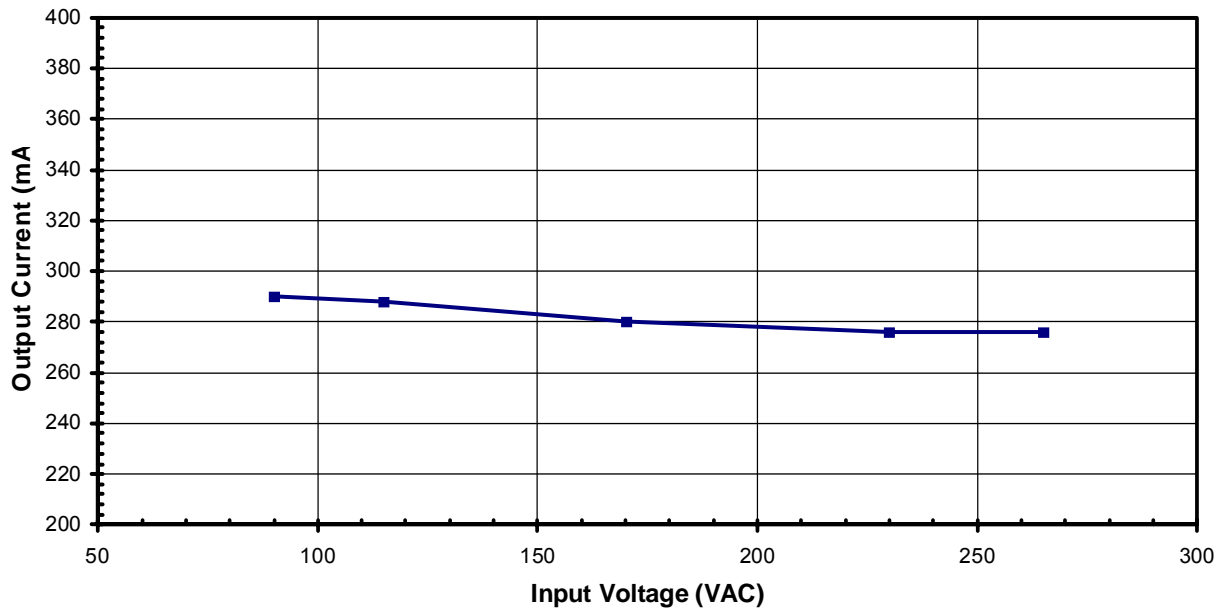


Figure 6 – Output Current vs. Input Voltage (stabilized, room temperature operation\*).

**7.3 Output VI Characteristic**

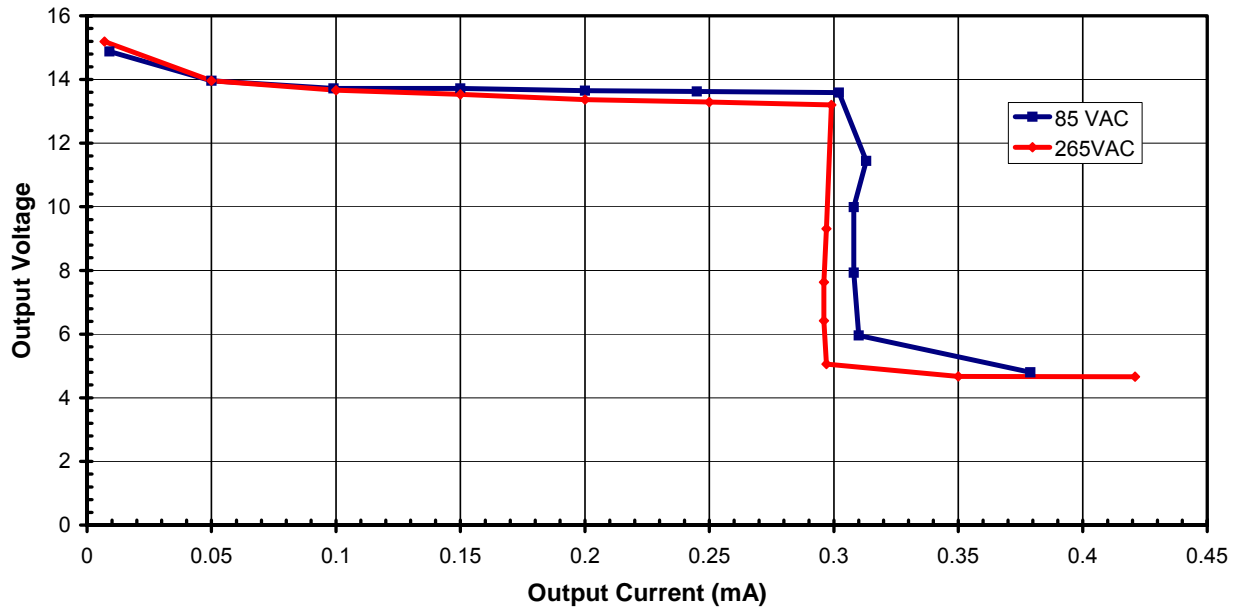
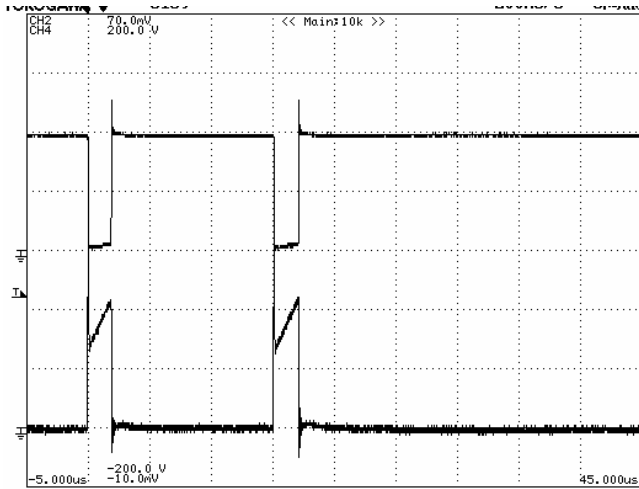


Figure 7 – Output Current vs. Output Voltage.

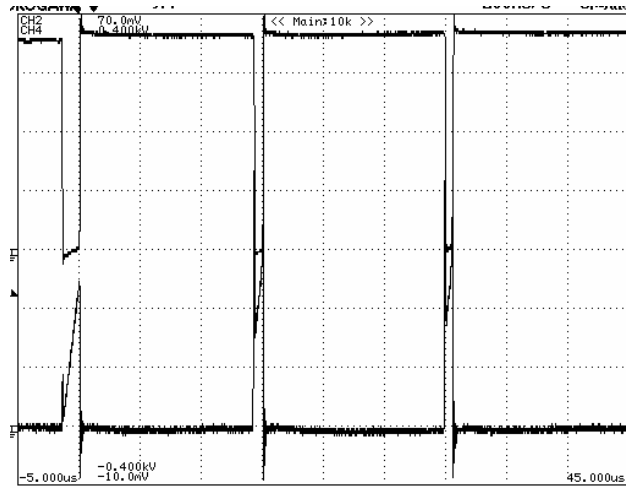
Note: When driving a LED load operation at <6V would not occur, therefore current walkout behavior is acceptable.

## 8 Waveforms

### 8.1 Drain Voltage and Current, Normal Operation

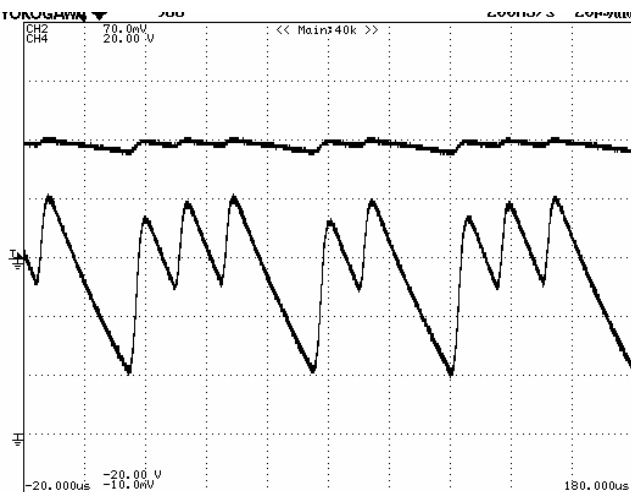


**Figure 7 – 85 VAC, Full Load.**  
 Upper:  $V_{DRAIN}$ , 50 V / div.  
 Lower:  $I_{DRAIN}$  0.20 A / div, 5  $\mu$ s / div.

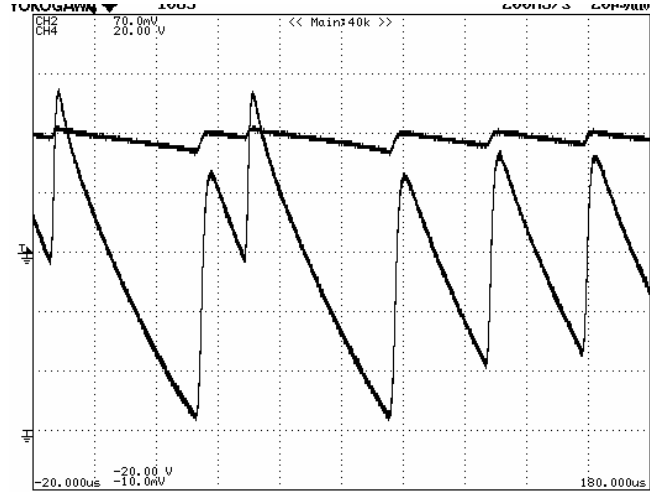


**Figure 8 – 265 VAC, Full Load**  
 Upper:  $V_{DRAIN}$ , 100 V / div.  
 Lower:  $I_{DRAIN}$  0.20 A / div, 5  $\mu$ s / div.

### 8.2 Output Current and Voltage



**Figure 9 – 85 VAC, Full Load.**  
 Upper:  $V_{OUT}$ , 5 V / div.  
 Lower:  $I_{OUT}$ , 100 mA, 20  $\mu$ s / div.

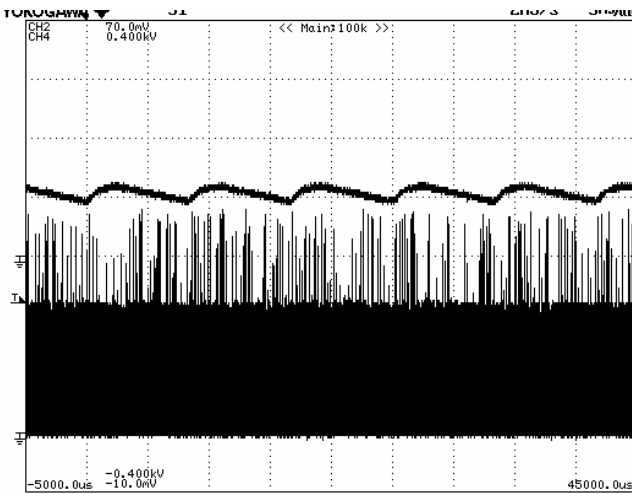


**Figure 10 – 265 VAC, Full Load.**  
 Upper:  $V_{OUT}$ , 5 V / div.  
 Lower:  $I_{OUT}$ , 100 mA, 20  $\mu$ s / div.

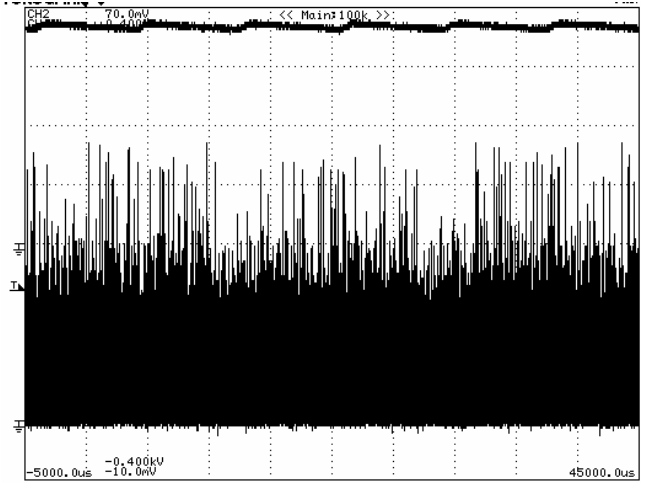




**8.3 Drain Current and Bulk Capacitor Voltage**

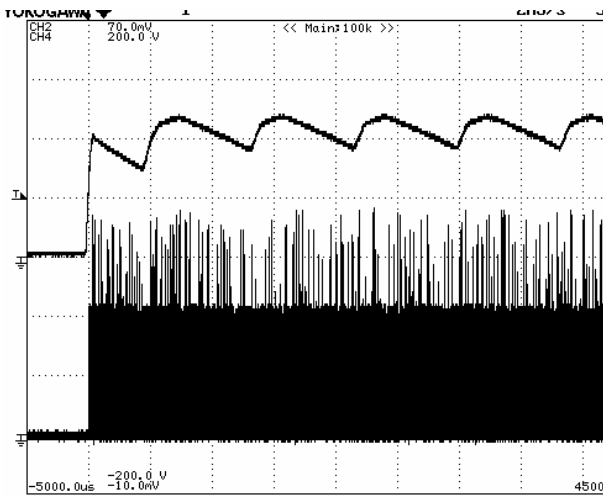


**Figure 11 – 85 VAC, Full Load.**  
 Upper:  $V_{BULK}$ , 100 V / div.  
 Lower:  $I_{DRAIN}$ , 200 mA, 5 ms / div.

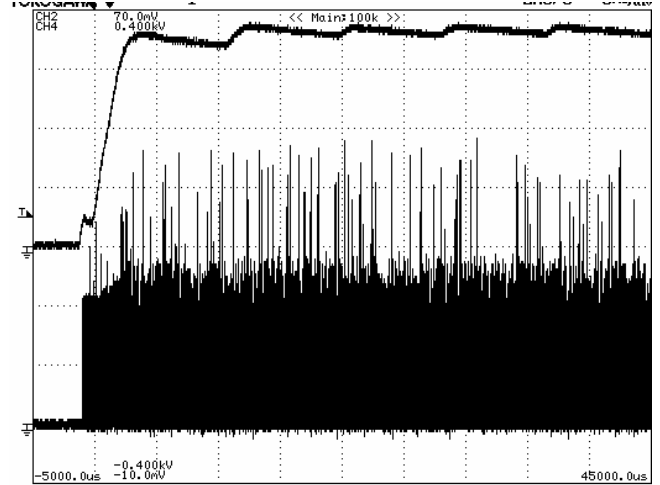


**Figure 12 – 265 VAC, Full Load.**  
 Upper:  $V_{BULK}$ , 100 V / div.  
 Lower:  $I_{DRAIN}$ , 200 mA, 5 ms / div.

**8.4 Startup Drain Current and Bulk Capacitor Voltage**

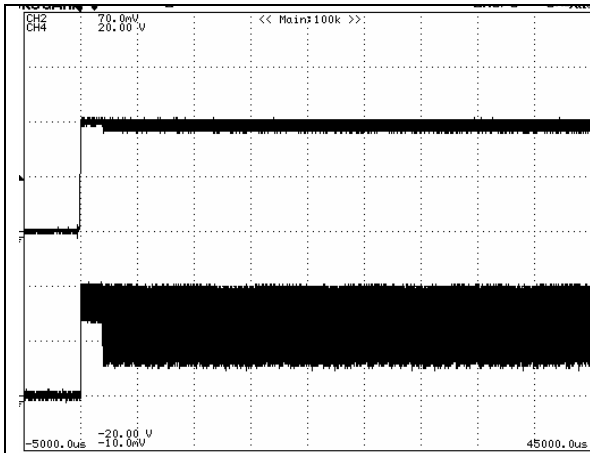


**Figure 13 – 85 VAC, Full Load.**  
 Upper:  $V_{BULK}$ , 50 V / div.  
 Lower:  $I_{DRAIN}$ , 200 mA, 5 ms / div.

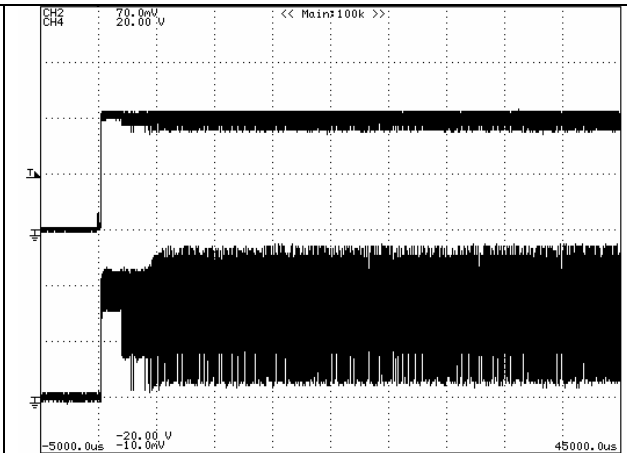


**Figure 14 – 265 VAC, Full Load.**  
 Upper:  $V_{BULK}$ , 200 V / div.  
 Lower:  $I_{DRAIN}$ , 200 mA, 5 ms / div.

### 8.5 Startup Output Voltage and Current

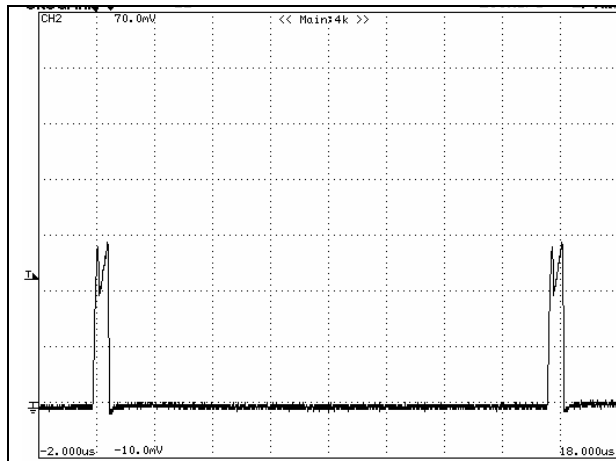


**Figure 15 – 85 VAC Full Load.**  
 Upper:  $V_{out}$ , 5 V / div.  
 Lower:  $I_{out}$ , 200 mA / div, 5 ms / div.

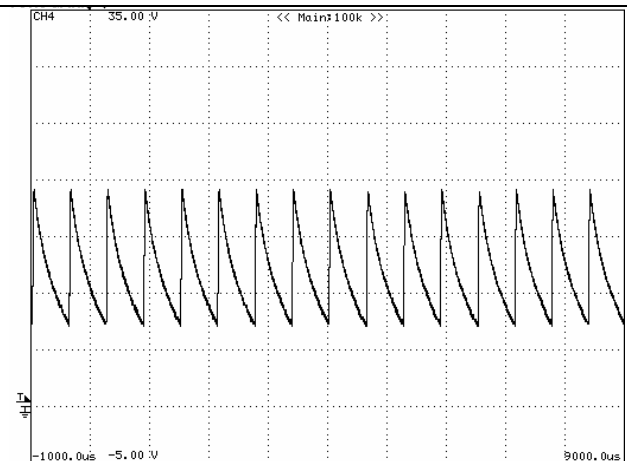


**Figure 16 – 265 VAC Full Load.**  
 Upper:  $V_{out}$ , 5 V / div.  
 Lower:  $I_{out}$ , 200 mA / div, 5 ms / div.

### 8.6 Fault Conditions



**Figure 17 – Drain Current with Output Shorted.**  
 500 mA/div, 2 ms / div.  
 $V_{in}$  = 265 VAC  
 Note: Peak drain current is 1.95 Amps.



**Figure 18 – Output Voltage with No Load.**  
 5 V/div, 1 ms / div.  
 $V_{in}$  = 265 VAC  
 Note: Peak voltage is 18 Volts.



## 9 Thermal Measurements

The power supply assembly was installed into the lamp socket base and the temperature of the LNK306DN SOURCE pin was measured, while the room ambient temperature was 25 °C. The power supply was driving the three load LEDs (delivering 3 watts).

<b>Vin (VAC)</b>	<b>Source Pin Temperature (°C)</b>
85	81
115	82
230	97
265	103

These results indicate that additional heatsinking may be required for example by arranging the LED heatsink to contact the top of the SO-8C package of U1.



### 10 Conducted EMI

The measurements were taken with the power supply driving the 3 LEDs. The worst-case input voltage was at 230 VAC, where the margin to the test limits was about 7 dB $\mu$ V.

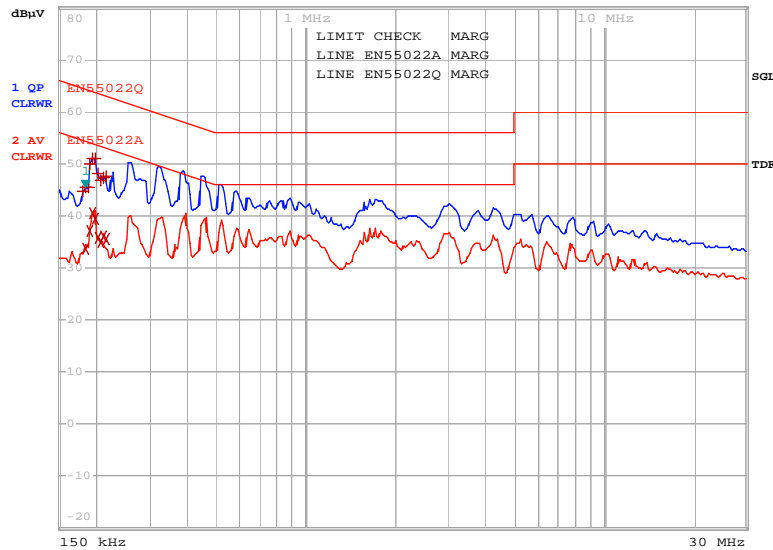


Figure 19 – Conducted EMI at 230 VAC.

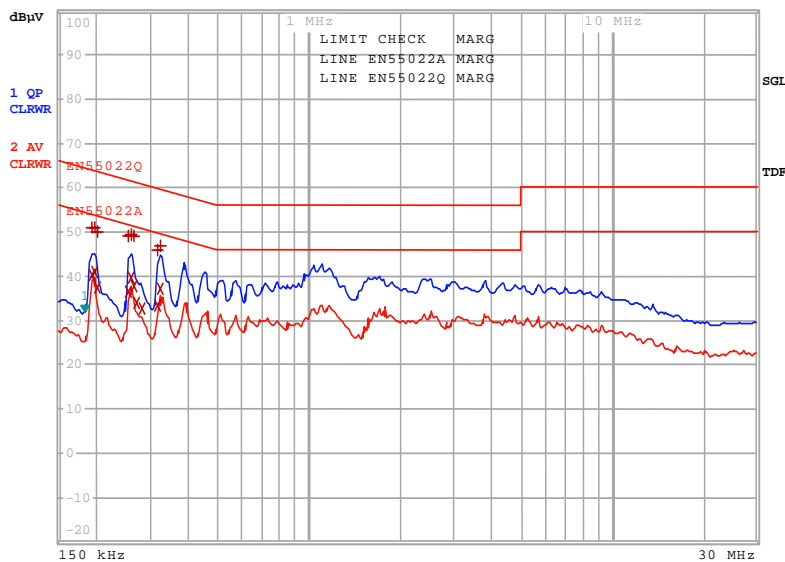


Figure 20 – Conducted EMI at 115 VAC.



## 10.1 Competitive Product EMI



**Figure 21** – Conducted EMI at 115VAC of competitive product.

This result was taken to demonstrate the poor EMI performance of similarly rated LED drivers on the market.



## 11 Revision History

<b>Date</b>	<b>Author</b>	<b>Revision</b>	<b>Description &amp; changes</b>	<b>Reviewed</b>
02/16/2007	JAJ	1.0	Initial publication	
03/7/2007		1.1	Updated pictures	



**Notes**



**For the latest updates, visit our website: [www.powerint.com](http://www.powerint.com)**

Power Integrations reserves the right to make changes to its products at any time to improve reliability or manufacturability. Power Integrations does not assume any liability arising from the use of any device or circuit described herein. POWER INTEGRATIONS MAKES NO WARRANTY HEREIN AND SPECIFICALLY DISCLAIMS ALL WARRANTIES INCLUDING, WITHOUT LIMITATION, THE IMPLIED WARRANTIES OF MERCHANTABILITY, FITNESS FOR A PARTICULAR PURPOSE, AND NON-INFRINGEMENT OF THIRD PARTY RIGHTS.

#### PATENT INFORMATION

The products and applications illustrated herein (including transformer construction and circuits external to the products) may be covered by one or more U.S. and foreign patents, or potentially by pending U.S. and foreign patent applications assigned to Power Integrations. A complete list of Power Integrations' patents may be found at [www.powerint.com](http://www.powerint.com). Power Integrations grants its customers a license under certain patent rights as set forth at <http://www.powerint.com/ip.htm>.

The PI Logo, **TOPSwitch**, **TinySwitch**, **LinkSwitch**, **DPA-Switch**, **PeakSwitch**, **EcoSmart**, **Clampless**, **E-Shield**, **Filterfuse**, **StackFET**, **PI Expert** and **PI FACTS** are trademarks of Power Integrations, Inc. Other trademarks are property of their respective companies. ©Copyright 2007 Power Integrations, Inc.

## Power Integrations Worldwide Sales Support Locations

#### WORLD HEADQUARTERS

5245 Hellyer Avenue  
San Jose, CA 95138, USA.  
Main: +1-408-414-9200  
Customer Service:  
Phone: +1-408-414-9665  
Fax: +1-408-414-9765  
*e-mail: [usasales@powerint.com](mailto:usasales@powerint.com)*

#### GERMANY

Rueckertstrasse 3  
D-80336, Munich  
Germany  
Phone: +49-89-5527-3910  
Fax: +49-89-5527-3920  
*e-mail: [eurosales@powerint.com](mailto:eurosales@powerint.com)*

#### JAPAN

1<sup>st</sup> Bldg Shin-Yokohama  
2-12-20 Kohoku-ku,  
Yokohama-shi, Kanagawa  
ken, Japan 222-0033  
Phone: +81-45-471-1021  
Fax: +81-45-471-3717  
*e-mail: [japansales@powerint.com](mailto:japansales@powerint.com)*

#### TAIWAN

5F, No. 318, Nei Hu Rd., Sec. 1  
Nei Hu Dist.  
Taipei, Taiwan 114, R.O.C.  
Phone: +886-2-2659-4570  
Fax: +886-2-2659-4550  
*e-mail: [taiwansales@powerint.com](mailto:taiwansales@powerint.com)*

#### CHINA (SHANGHAI)

Rm 807-808A,  
Pacheer Commercial Centre,  
555 Nanjing Rd. West  
Shanghai, P.R.C. 200041  
Phone: +86-21-6215-5548  
Fax: +86-21-6215-2468  
*e-mail: [chinasales@powerint.com](mailto:chinasales@powerint.com)*

#### INDIA

#1, 14<sup>th</sup> Main Road  
Vasanthanagar  
Bangalore-560052 India  
Phone: +91-80-41138020  
Fax: +91-80-41138023  
*e-mail: [indiasales@powerint.com](mailto:indiasales@powerint.com)*

#### KOREA

RM 602, 6FL  
Korea City Air Terminal B/D,  
159-6  
Samsung-Dong, Kangnam-Gu,  
Seoul, 135-728, Korea  
Phone: +82-2-2016-6610  
Fax: +82-2-2016-6630  
*e-mail: [koreasales@powerint.com](mailto:koreasales@powerint.com)*

#### UNITED KINGDOM

1st Floor, St. James's House  
East Street, Farnham  
Surrey, GU9 7TJ  
United Kingdom  
Phone: +44 (0) 1252-730-140  
Fax: +44 (0) 1252-727-689  
*e-mail: [eurosales@powerint.com](mailto:eurosales@powerint.com)*

#### CHINA (SHENZHEN)

Room 2206-2207, Block A,  
Elec. Sci. Tech. Bldg.  
2070 Shennan Zhong Rd.  
Shenzhen, Guangdong,  
China, 518031  
Phone: +86-755-8379-3243  
Fax: +86-755-8379-5828  
*e-mail: [chinasales@powerint.com](mailto:chinasales@powerint.com)*

#### ITALY

Via De Amicis 2  
20091 Bresso MI – Italy  
Phone: +39-028-928-6000  
Fax: +39-028-928-6009  
*e-mail: [eurosales@powerint.com](mailto:eurosales@powerint.com)*

#### SINGAPORE

51 Newton Road,  
#15-08/10 Goldhill Plaza,  
Singapore, 308900  
Phone: +65-6358-2160  
Fax: +65-6358-2015  
*e-mail: [singaporesales@powerint.com](mailto:singaporesales@powerint.com)*

#### APPLICATIONS HOTLINE

World Wide +1-408-414-9660

#### APPLICATIONS FAX

World Wide +1-408-414-9760



**Power Integrations, Inc.**  
Tel: +1 408 414 9200 Fax: +1 408 414 9201  
[www.powerint.com](http://www.powerint.com)