

LM2743-19A Demo Board

National Semiconductor
Application Note 1640
Ricardo Capetillo
May 2007



Introduction

This application notes describes the LM2743 printed circuit board (PCB) design and provides an example typical application circuit. The LM2743 is a voltage mode PWM buck controller which implements synchronous rectification. It provides a low cost, high power density, and efficient point of load solution. In steady state operation the LM2743 is always synchronous, even at no load, thus simplifying the compensation design. The current limit protection does not require a current limit resistor in the power path, but is achieved by sensing the voltage V_{DS} across the low side MOSFET. Though the control sections of the IC are rated for 3 to 6V (V_{CC}), the driver sections are designed to accept input supply rails (V_{IN}) as high as 16V.

Specifics Of The Board

This demo board targets the fixed and mobile telecommunications, industrial electronics, and distributed power markets. The demo board has a V_{IN} range of 8V to 14V and a LDO regulator, the LP2937, powers V_{CC} by regulating a 5V output voltage. The LM2743 regulates to an output range of 1.2V to 3.3V at 19A with a switching frequency of 300 kHz. Note, the demo board is optimized for the above parameters, thus for additional design modifications refer to the Design Consideration section of the LM2743 data sheet. The PCB is designed on four layers, the top and bottom layers are 2oz. copper and the two inner layers are 1oz. copper. The board measures 2.19 in. x 1.03 in. x 0.41 in. (56 mm x 26.2 mm x 10.3 mm) (l, w, h) on a FR4 laminate.

Feature Options

When the tracking feature of the LM2743 is required for use, remove the jumper that connects the soft-start capacitor C10 and connect the resistor divider, on designators R13 and R14, see *Figure 1*. The Track terminal has been provided for your connecting convenience. The demo board switching frequen-

cy is user adjustable; note increasing the switching frequency results in a lower inductor current ripple and input and output voltage ripple (if the component values are the same). Monitor the MOSFET junction temperature since switching losses will increase, and do not exceed the maximum junction temperature of the MOSFET. Refer to the MOSFET manufacturer datasheet for maximum junction temperature specification and heat sinking guidelines.

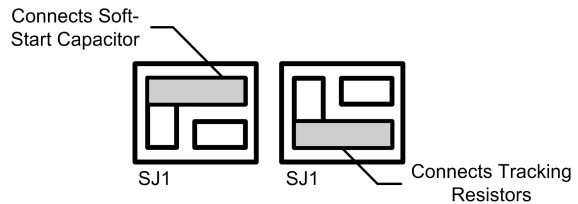
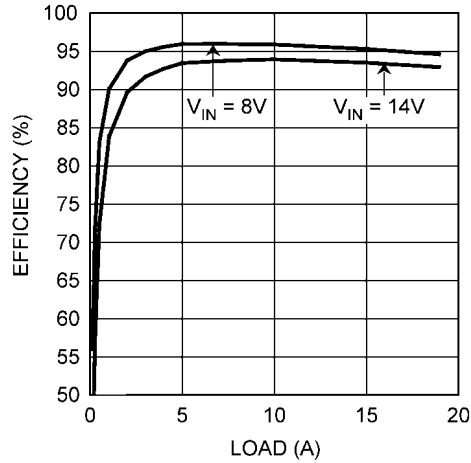

FIGURE 1. Soft-Start and Tracking Jumper

Specification Summary

- Space saving footprint
- Wide ambient temperature range: -40 °C to 65 °C
- Input voltage range: 8V to 14V
- Adjustable output voltage: 1.2V to 3.3V
- No minimum load requirement
- Remote ON/OFF
- Power good signal
- Fixed switching frequency: 300 kHz
- Current Limit Protection
- Master power supply start-up tracking function
- Adjustable soft-start
- Small size 2.19 in. x 1.03 in. x 0.41 in. (56 mm x 26.2 mm x 10.3 mm)

Performance Characteristics Efficiency



30022401

FIGURE 2. Efficiency vs. Load Current
 $V_{OUT} = 3.3V, f_{SW} = 300\text{ kHz}$

Switch Node Voltage and Output Voltage Ripple

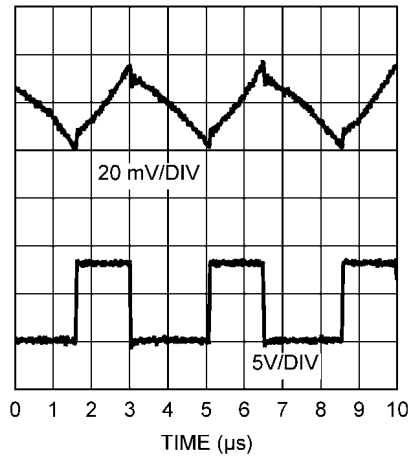

30022404

FIGURE 3. $V_{IN} = 8V, V_{OUT} = 3.3V,$
 $I_{LOAD} = 100\text{ mA}, f_{SW} = 300\text{ kHz}$
 20 MHz Bandwidth Limit

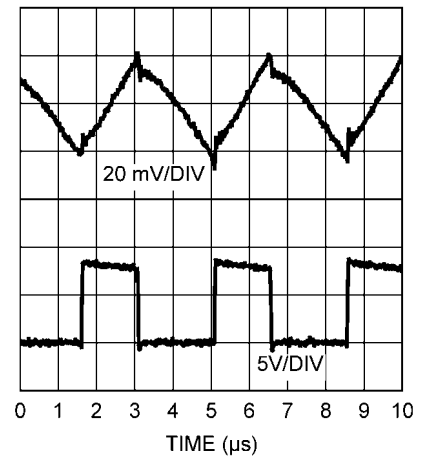

30022403

FIGURE 4. $V_{IN} = 8V, V_{OUT} = 3.3V,$
 $I_{LOAD} = 19A, f_{SW} = 300\text{ kHz}$
 20 MHz Bandwidth Limit

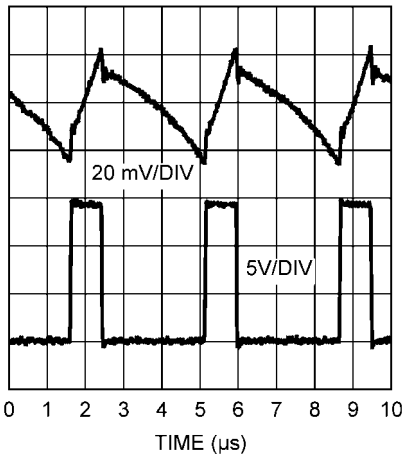

30022402

FIGURE 5. $V_{IN} = 14V$, $V_{OUT} = 3.3V$,
 $I_{LOAD} = 100\text{ mA}$, $f_{SW} = 300\text{ kHz}$
 20 MHz Bandwidth Limit

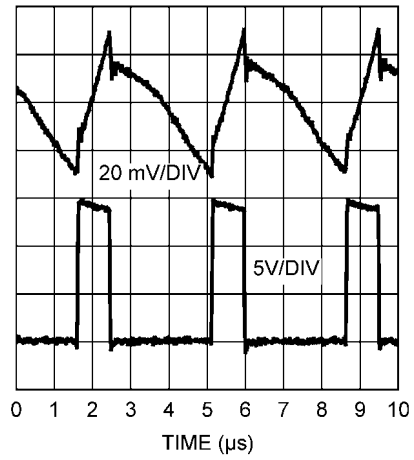

30022405

FIGURE 6. $V_{IN} = 14V$, $V_{OUT} = 3.3V$,
 $I_{LOAD} = 19A$, $f_{SW} = 300\text{ kHz}$
 20 MHz Bandwidth Limit

Load Transient Response

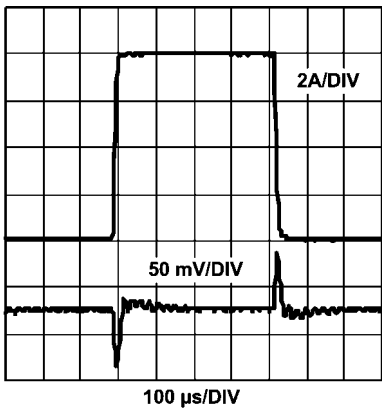

30022409

FIGURE 7. $V_{IN} = 14V$, $V_{OUT} = 3.3V$
 $I_{LOAD} = 2A\text{ to }10A$
 CH1: V_{OUT} , CH2: I_{LOAD}

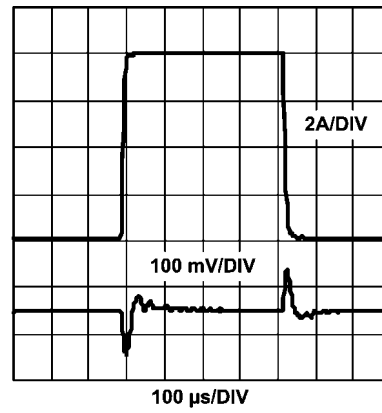

30022407

FIGURE 9. $V_{IN} = 8V$, $V_{OUT} = 3.3V$
 $I_{LOAD} = 2A\text{ to }10A$
 CH1: V_{OUT} , CH2: I_{LOAD}

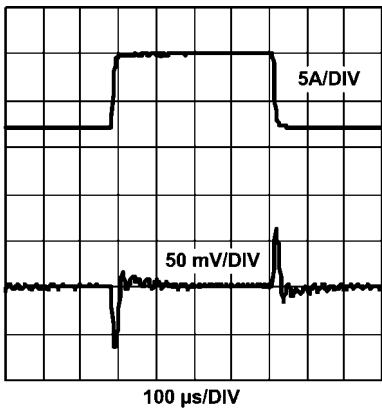

30022410

FIGURE 8. $V_{IN} = 14V$, $V_{OUT} = 3.3V$
 $I_{LOAD} = 11A\text{ to }19A$
 CH1: V_{OUT} , CH2: I_{LOAD}

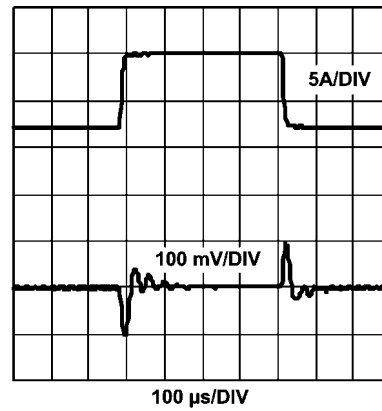

30022408

FIGURE 10. $V_{IN} = 8V$, $V_{OUT} = 3.3V$
 $I_{LOAD} = 11A\text{ to }19A$
 CH1: V_{OUT} , CH2: I_{LOAD}

Bill of Materials for LM2743 POL EVB (Vin: 8V to 14V, Vout:3.3V, 19A)

Location	Part Number	Type	Size	Parameters	Qty	Vendor
U1	LM2743	Syn. Buck Controller	TSSOP-14	Vin: 4.5V - 5.5V	1	NSC
U2	LM27937IMP-5.0	Linear Regulator 5V,500mA	SOT-223	5V, 500mA	1	NSC
L1	SER2010-202ML	Inductor		2uH, 27A, 0.852mohm	1	Coilcraft
Q1-2	IRF6633	N-MOSFET	DirectFET-MP	20V, 16A, 4.1mohm, 11nC	2	Vishay
Q3	IRF6609	N-MOSFET	DirectFET-MT	20V, 150A, 2mohm, 46nC	1	Vishay
D1	SL22-E3/2C	Schottky Diode	SMB	20V, 2A	1	Vishay
D2	MBRS0520	Schottky Diode	SOD123	20V, 0.5A	1	Vishay
C1, 2	GRM32ER61C226KE20L	Ceramic Capacitor	1210	22µF, 25V, X7R, 5%	2	Murata
C3, 11	GRM319R71H104KA01B	Ceramic Capacitor	1206	100nF, 25V, X7R, 10%	2	Murata
C14	GRM319R71H474KA01B	Ceramic Capacitor	1206	470nF, 25V, X7R, 10%	1	Murata
C9	GRM1885C1H1210JA01	Ceramic Capacitor	0603	120pF, 50V, C0G, 5%	1	Murata
C6	GRM188R71H222KA01	Ceramic Capacitor	0603	2.2nF, 50V, X7R, 10%	1	Murata
C8	GRM188R71H332KA01	Ceramic Capacitor	0603	3.3nF, 50V, X7R, 10%	1	Murata
C10	GRM188R71H153KA01	Ceramic Capacitor	0603	15nF, 50V, X7R, 10%	1	Murata
C12	GRM40X7R472K25	Ceramic Capacitor	0805	470nF, 25V, X7R, 10%	1	Murata
C13	1206D226MAT	Ceramic Capacitor	1206	22µF, 6.3V, X5R, 20%	1	AVX
C4, 5	6SVPC220M	OS-CON	C6	220µF, 6.3V, 20%	2	Sanyo
R1,18	CRCW06030R00F	Chip Resistor	0603	0ohm	2	Vishay
R2	CRCW06032151F	Chip Resistor	0603	2.15k, 1%	1	Vishay
R3, R17	CRCW06031002F	Chip Resistor	0603	10k, 1%	2	Vishay
R4	CRCW06032211F	Chip Resistor	0603	2.21k, 1%	1	Vishay
R10, 11	CRCW06031003F	Chip Resistor	0603	100k, 1%	2	Vishay
R5, 6, 8	CRCW06032R21F	Chip Resistor	0603	2.21ohm, 1%	3	Vishay
R7, 9	CRCW06034702F	Chip Resistor	0603	47k, 1%	2	Vishay
R12	CRCW06038451F	Chip Resistor	0603	8.45k, 1%	1	Vishay
R15	CRCW06031821F	Chip Resistor	0603	1.82k, 1%	1	Vishay
R16	CRCW060310R0F	Chip Resistor	0603	10ohm, 1%	1	Vishay
-	-	F-Pin			8	
-	-	Pin 90 deg., SIP, 6 way	Pitch: 2.54mm		1	

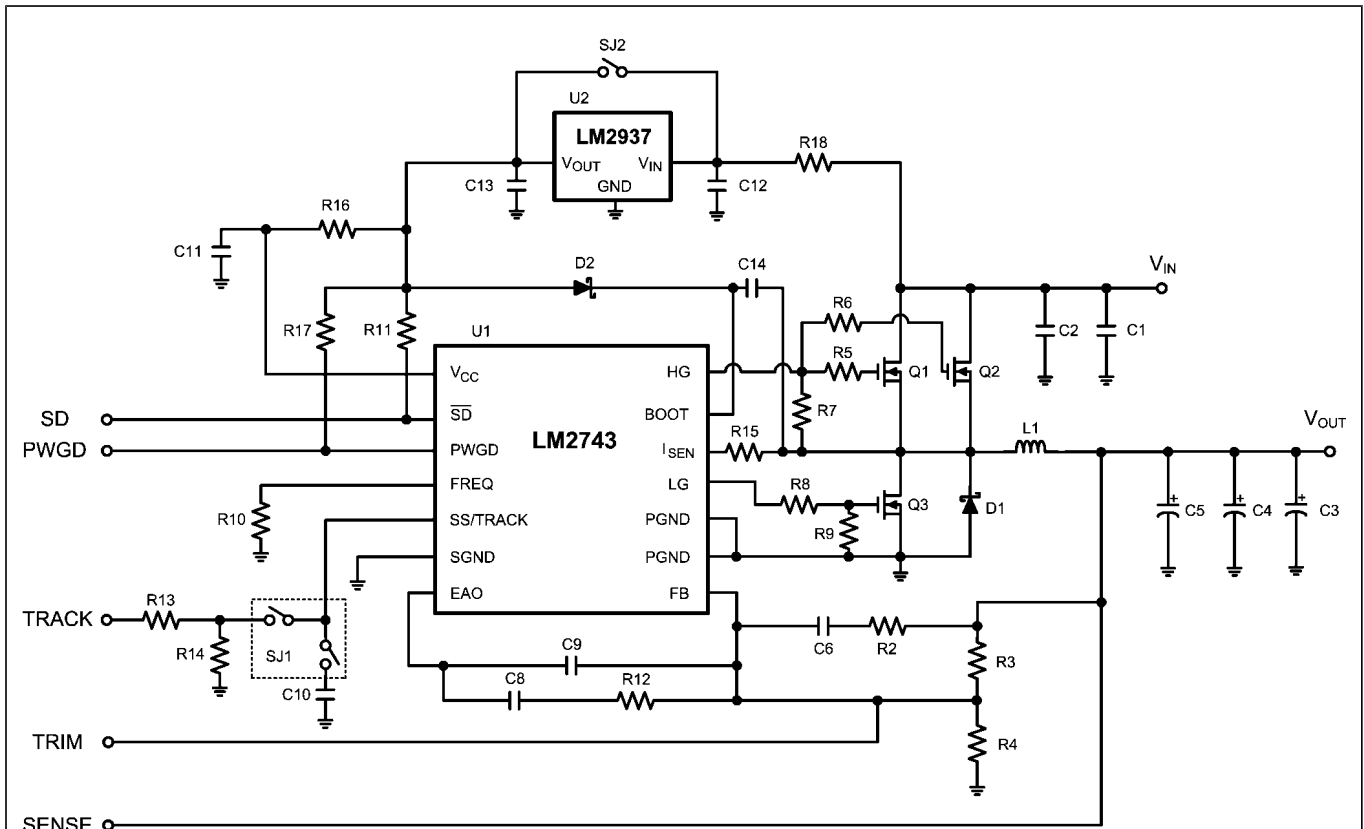

30022406

FIGURE 11. 300 kHz Demo Board Schematic

PCB Layout

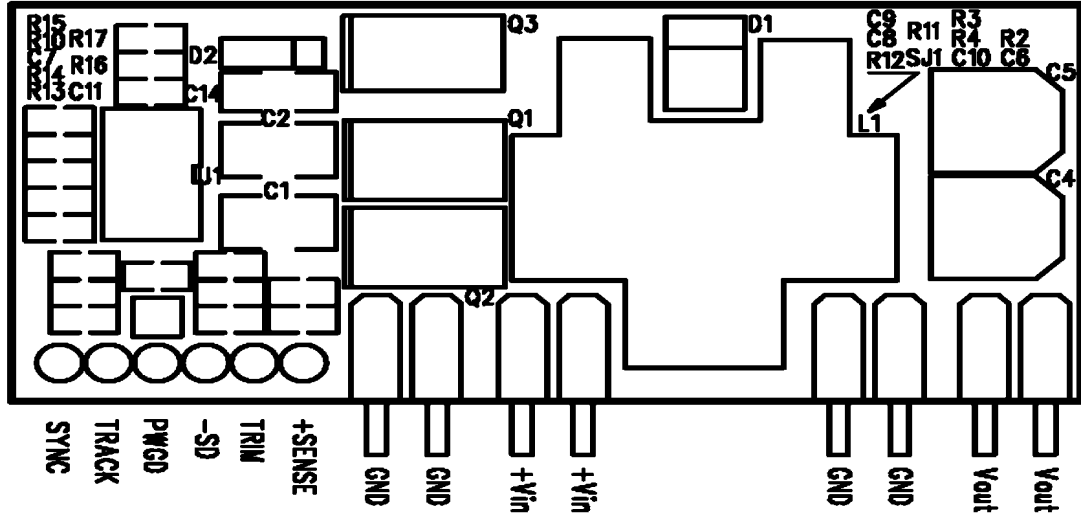

30022411

FIGURE 12. Top Silkscreen

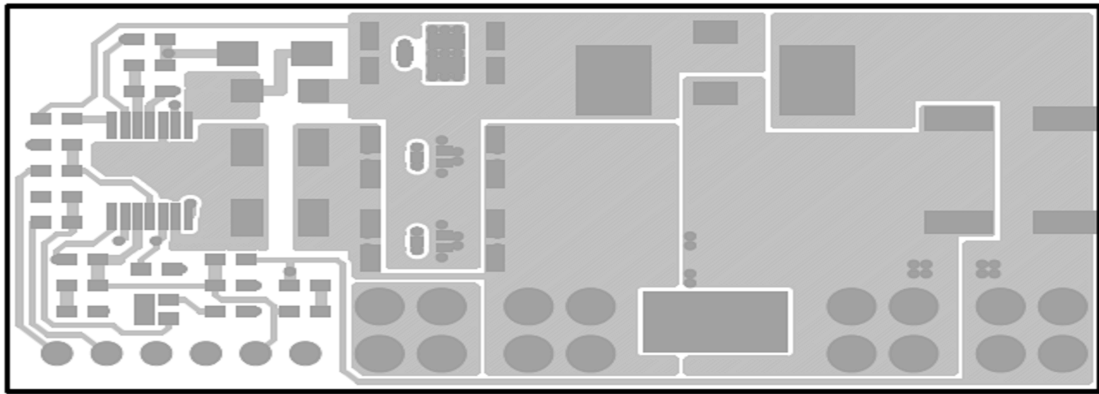

30022412

FIGURE 13. Top Copper Layer

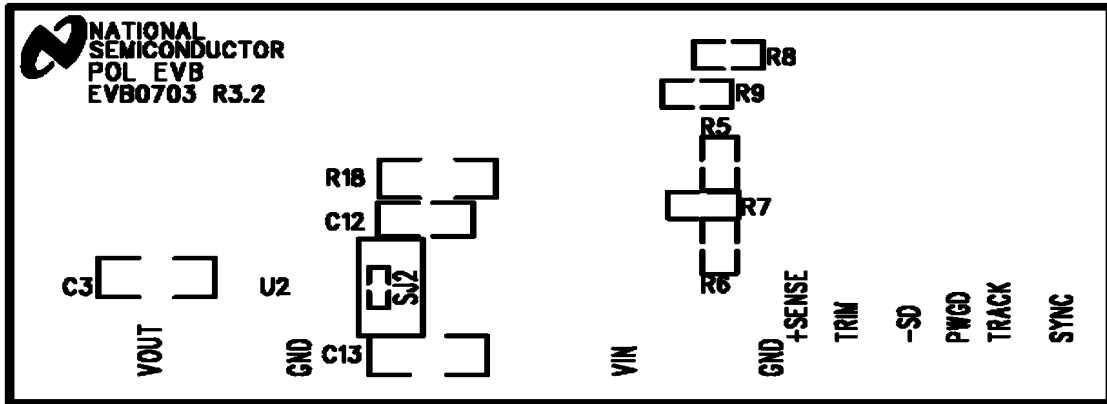

30022413

FIGURE 14. Bottom Silkscreen

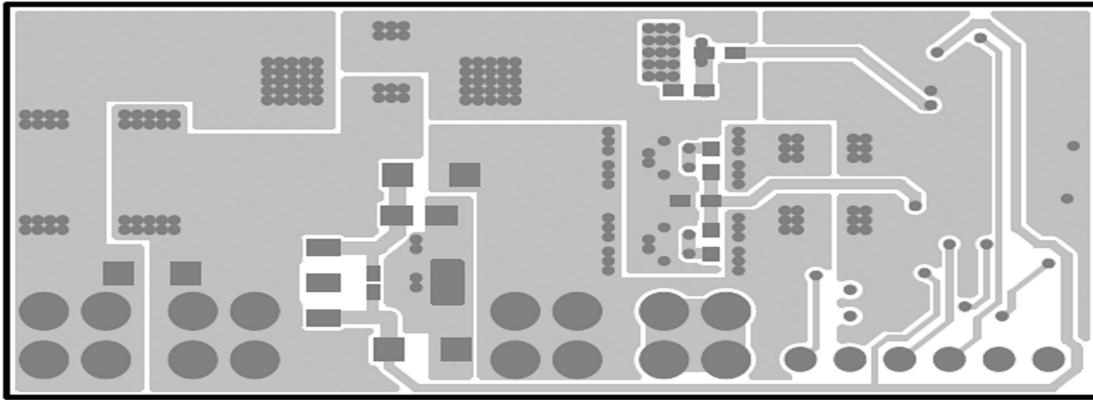

30022414

FIGURE 15. Bottom Copper Layer

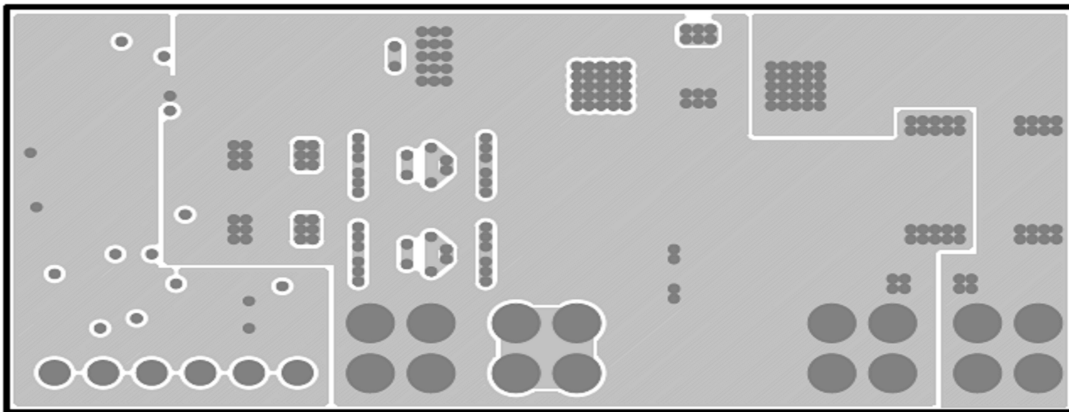

30022415

FIGURE 16. Internal Layer-1 (GND Copper)

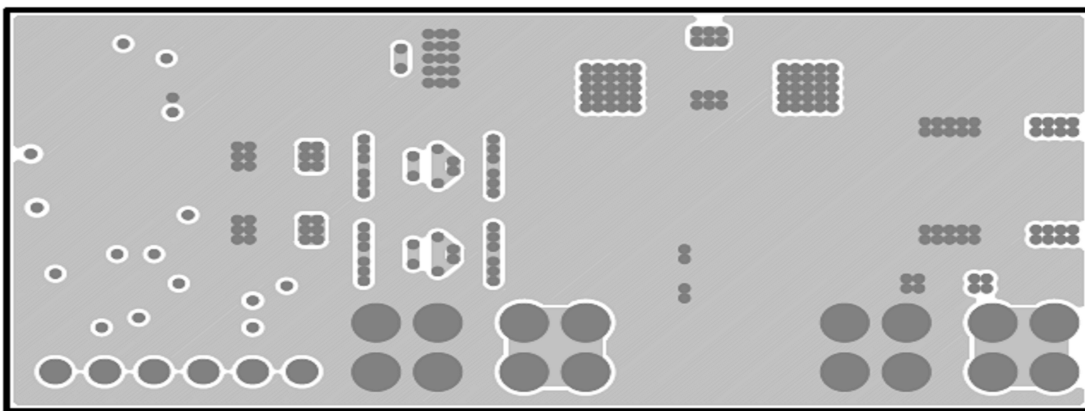

30022416

FIGURE 17. Internal Layer-2 (GND Copper)

Notes

THE CONTENTS OF THIS DOCUMENT ARE PROVIDED IN CONNECTION WITH NATIONAL SEMICONDUCTOR CORPORATION ("NATIONAL") PRODUCTS. NATIONAL MAKES NO REPRESENTATIONS OR WARRANTIES WITH RESPECT TO THE ACCURACY OR COMPLETENESS OF THE CONTENTS OF THIS PUBLICATION AND RESERVES THE RIGHT TO MAKE CHANGES TO SPECIFICATIONS AND PRODUCT DESCRIPTIONS AT ANY TIME WITHOUT NOTICE. NO LICENSE, WHETHER EXPRESS, IMPLIED, ARISING BY ESTOPPEL OR OTHERWISE, TO ANY INTELLECTUAL PROPERTY RIGHTS IS GRANTED BY THIS DOCUMENT.

TESTING AND OTHER QUALITY CONTROLS ARE USED TO THE EXTENT NATIONAL DEEMS NECESSARY TO SUPPORT NATIONAL'S PRODUCT WARRANTY. EXCEPT WHERE MANDATED BY GOVERNMENT REQUIREMENTS, TESTING OF ALL PARAMETERS OF EACH PRODUCT IS NOT NECESSARILY PERFORMED. NATIONAL ASSUMES NO LIABILITY FOR APPLICATIONS ASSISTANCE OR BUYER PRODUCT DESIGN. BUYERS ARE RESPONSIBLE FOR THEIR PRODUCTS AND APPLICATIONS USING NATIONAL COMPONENTS. PRIOR TO USING OR DISTRIBUTING ANY PRODUCTS THAT INCLUDE NATIONAL COMPONENTS, BUYERS SHOULD PROVIDE ADEQUATE DESIGN, TESTING AND OPERATING SAFEGUARDS.

EXCEPT AS PROVIDED IN NATIONAL'S TERMS AND CONDITIONS OF SALE FOR SUCH PRODUCTS, NATIONAL ASSUMES NO LIABILITY WHATSOEVER, AND NATIONAL DISCLAIMS ANY EXPRESS OR IMPLIED WARRANTY RELATING TO THE SALE AND/OR USE OF NATIONAL PRODUCTS INCLUDING LIABILITY OR WARRANTIES RELATING TO FITNESS FOR A PARTICULAR PURPOSE, MERCHANTABILITY, OR INFRINGEMENT OF ANY PATENT, COPYRIGHT OR OTHER INTELLECTUAL PROPERTY RIGHT.

LIFE SUPPORT POLICY

NATIONAL'S PRODUCTS ARE NOT AUTHORIZED FOR USE AS CRITICAL COMPONENTS IN LIFE SUPPORT DEVICES OR SYSTEMS WITHOUT THE EXPRESS PRIOR WRITTEN APPROVAL OF THE CHIEF EXECUTIVE OFFICER AND GENERAL COUNSEL OF NATIONAL SEMICONDUCTOR CORPORATION. As used herein:

Life support devices or systems are devices which (a) are intended for surgical implant into the body, or (b) support or sustain life and whose failure to perform when properly used in accordance with instructions for use provided in the labeling can be reasonably expected to result in a significant injury to the user. A critical component is any component in a life support device or system whose failure to perform can be reasonably expected to cause the failure of the life support device or system or to affect its safety or effectiveness.

National Semiconductor and the National Semiconductor logo are registered trademarks of National Semiconductor Corporation. All other brand or product names may be trademarks or registered trademarks of their respective holders.

Copyright© 2007 National Semiconductor Corporation

For the most current product information visit us at www.national.com



**National Semiconductor
Americas Customer
Support Center**
Email:
new.feedback@nsc.com
Tel: 1-800-272-9959

**National Semiconductor Europe
Customer Support Center**
Fax: +49 (0) 180-530-85-86
Email: europe.support@nsc.com
Deutsch Tel: +49 (0) 69 9508 6208
English Tel: +49 (0) 870 24 0 2171
Français Tel: +33 (0) 1 41 91 8790

**National Semiconductor Asia
Pacific Customer Support Center**
Email: ap.support@nsc.com

**National Semiconductor Japan
Customer Support Center**
Fax: 81-3-5639-7507
Email: jpn.feedback@nsc.com
Tel: 81-3-5639-7560