

LM2832X 6-Pin LLP Demo Board

National Semiconductor
Application Note 1552
Matthew Reynolds
January 8, 2009



Introduction

The demo board included in this shipment converts 3V to 5.5V input to 1.8V output for 2A load current using the LM2832X 1.6 MHz DC-DC switching converter. This is a 4-layer board using the internal layers as a VIN plane and Ground plane.

A bill of materials below describes the parts used on this demo board. A schematic and layout have also been included below

along with measured performance characteristics. The above restrictions for the input voltage are valid only for the demo board as shipped with the demo board schematic below.

Operating Conditions

$V_{IN} = 3V$ to $5.5V$
 $V_O = 1.8V$
 $I_O = 2A$

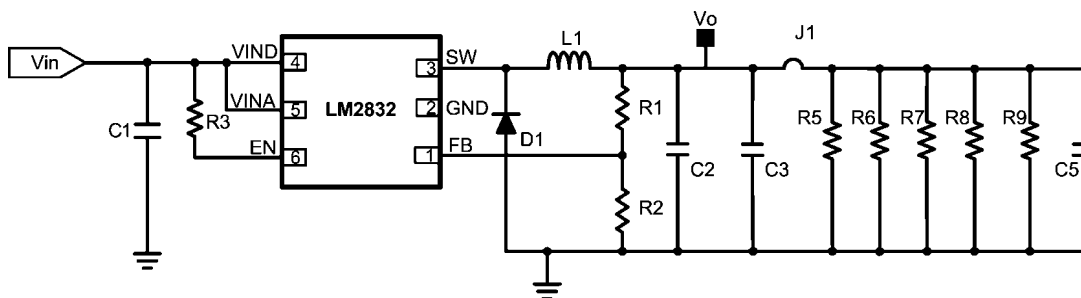

LM2832X 6-Pin LLP Demo Board Schematic

30000901

Pin-Out

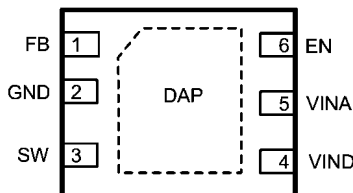

30000902

Pin Description 6-Pin LLP

Pin	Name	Function
1	FB	Feedback pin. Connect to external resistor divider to set output voltage.
2	GND	Signal and power ground pin. Place the bottom resistor of the feedback network as close as possible to this pin.
3	SW	Output switch. Connect to the inductor and catch diode.
4	VIND	Power Input supply.
5	VINA	Control circuitry supply voltage. Connect VINA to VIND on PC board.
6	EN	Enable control input. Logic high enables operation. Do not allow this pin to float or be greater than $VINA + 0.3V$.
DAP	Die Attach Pad	Connect to system ground for low thermal impedance, but it cannot be used as a primary GND connection.

LM2832 Gain/Phase 5V to 1.8V @ 1A

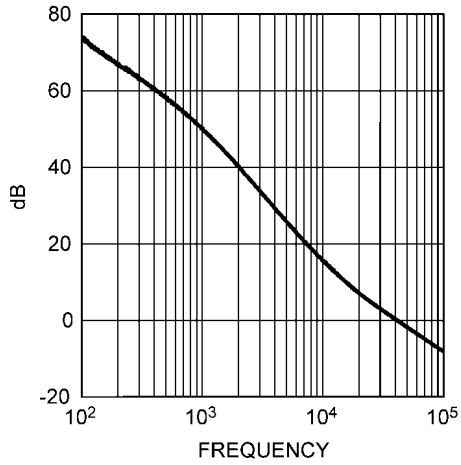

30000903

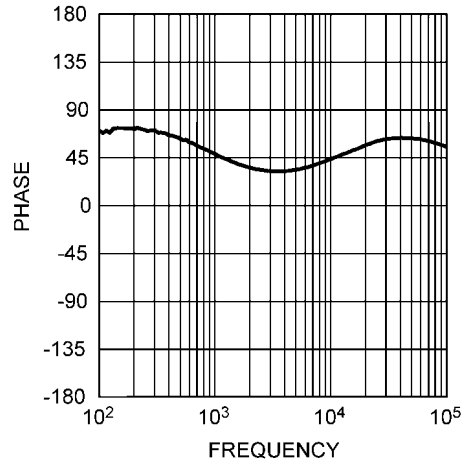

30000904

LM2832 Efficiency: Vin = 3.3V, Vo = 1.8V

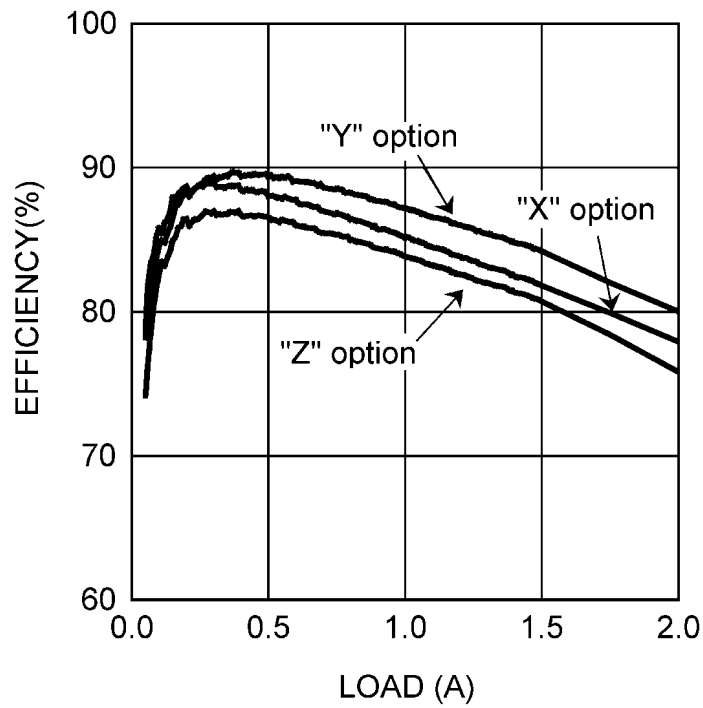

30000905

Bill Of Materials LM2832X-Version

Part ID	Part Value	Manufacturer	Part Number
U1	2A Buck Regulator	NSC	LM2832X
C1, Input Cap	22 μ F, 6.3V, X5R	TDK	C3216X5ROJ226M
C2 Output Cap	22 μ F, 6.3V, X5R	TDK	C3216X5ROJ226M
C3 Output Cap	22 μ F, 6.3V, X5R	TDK	C3216X5ROJ226M
D1, Catch Diode	0.3V _f Schottky 1.5A, 30V _R	TOSHIBA	CRS08
L1	3.3 μ H, 3.5A	CoilCraft	MSS7341-332NL
R1	20.0 k Ω , 1%	Vishay	CRCW08052002F
R2	10.0 k Ω , 1%	Vishay	CRCW08051002F
R3	20.0 k Ω , 1%	Vishay	CRCW08052002F
J1	No Load		
R5 – R9	No Load		

Layout

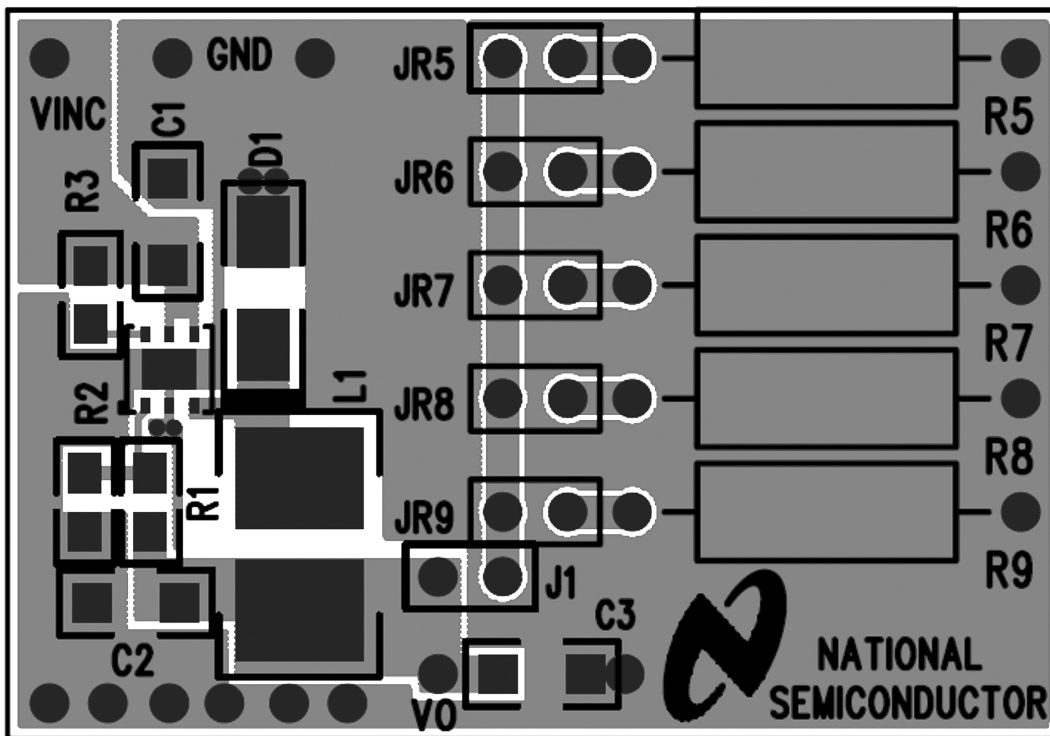

Top Layer

30000906

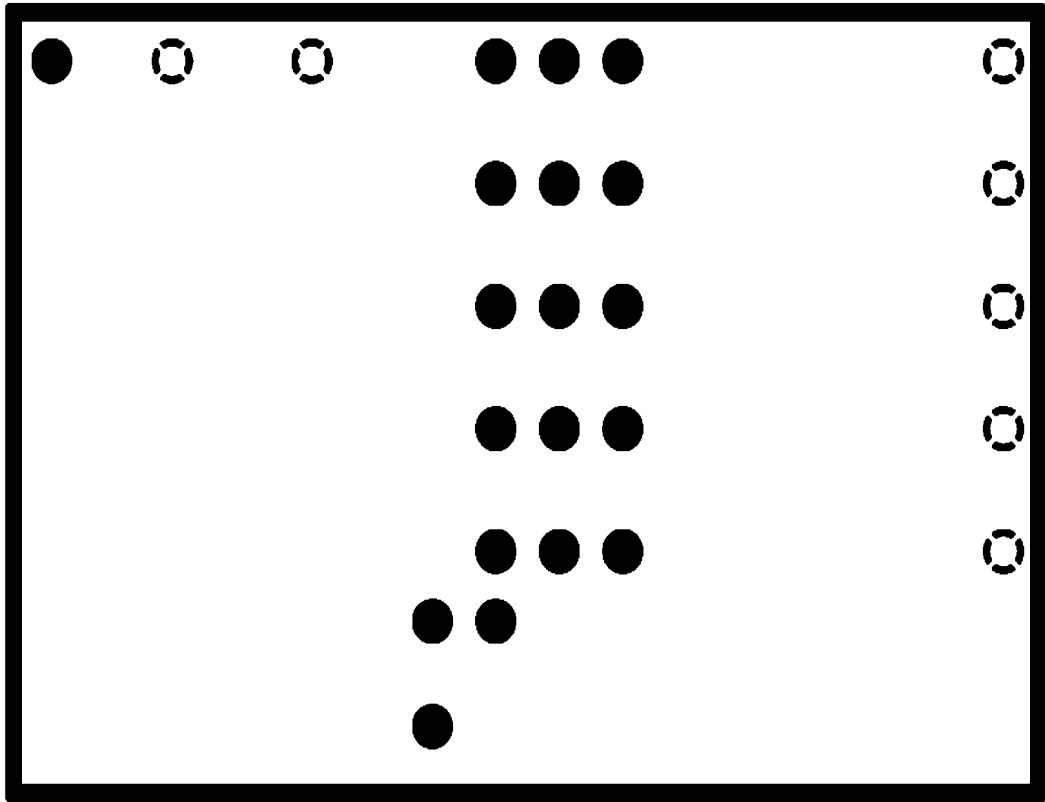

Internal Plane 1 (GND)

30000907

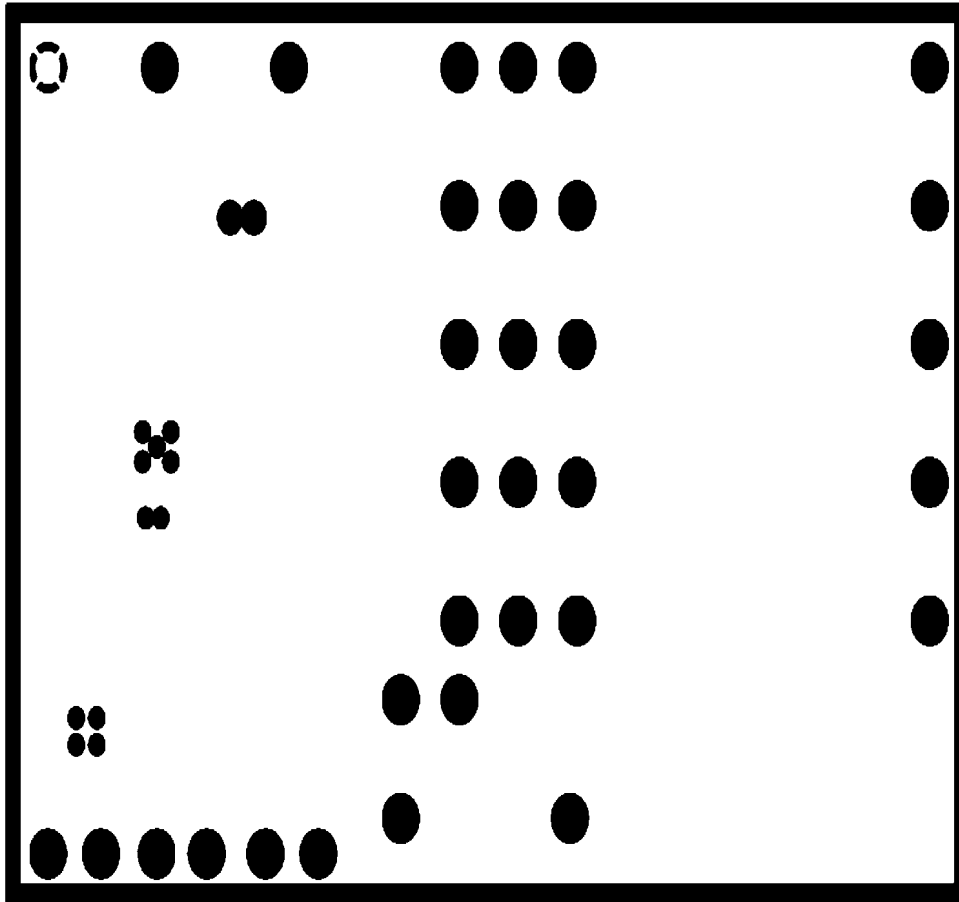

30000908

Internal Plane 2 (VIN)

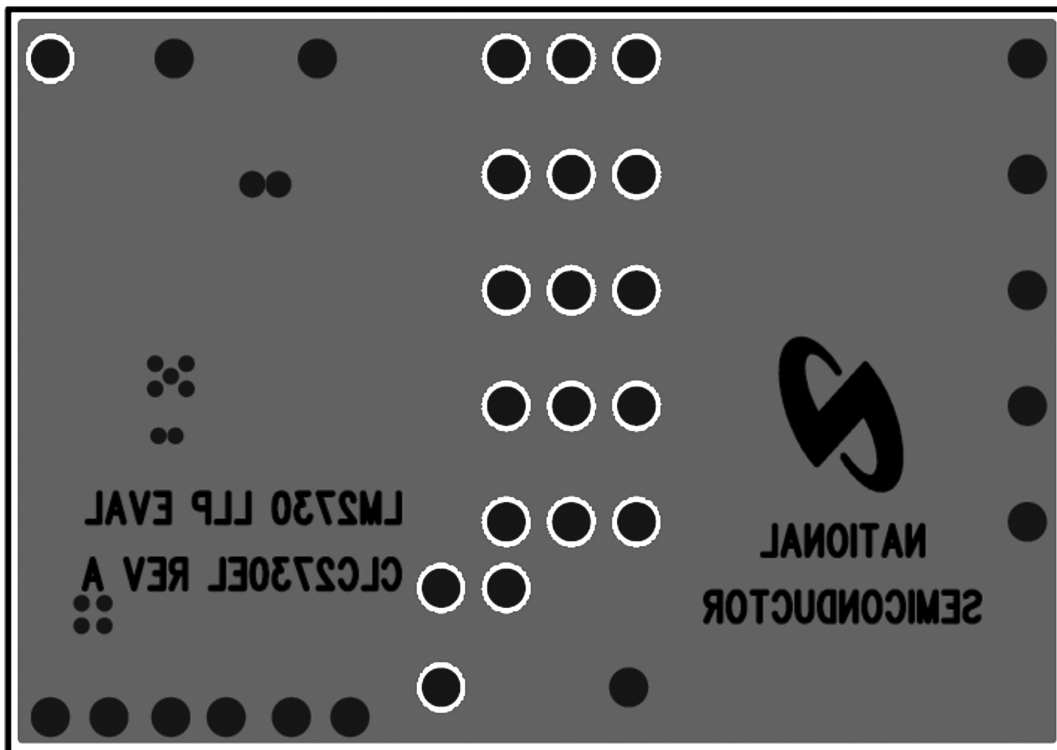

30000909

Bottom Layer

For more National Semiconductor product information and proven design tools, visit the following Web sites at:

Products		Design Support	
Amplifiers	www.national.com/amplifiers	WEBENCH® Tools	www.national.com/webench
Audio	www.national.com/audio	App Notes	www.national.com/appnotes
Clock and Timing	www.national.com/timing	Reference Designs	www.national.com/refdesigns
Data Converters	www.national.com/adc	Samples	www.national.com/samples
Interface	www.national.com/interface	Eval Boards	www.national.com/evalboards
LVDS	www.national.com/lvds	Packaging	www.national.com/packaging
Power Management	www.national.com/power	Green Compliance	www.national.com/quality/green
Switching Regulators	www.national.com/switchers	Distributors	www.national.com/contacts
LDOs	www.national.com/ldo	Quality and Reliability	www.national.com/quality
LED Lighting	www.national.com/led	Feedback/Support	www.national.com/feedback
Voltage Reference	www.national.com/vref	Design Made Easy	www.national.com/easy
PowerWise® Solutions	www.national.com/powerwise	Solutions	www.national.com/solutions
Serial Digital Interface (SDI)	www.national.com/sdi	Mil/Aero	www.national.com/milaero
Temperature Sensors	www.national.com/tempsensors	Solar Magic®	www.national.com/solarmagic
Wireless (PLL/VCO)	www.national.com/wireless	Analog University®	www.national.com/AU

THE CONTENTS OF THIS DOCUMENT ARE PROVIDED IN CONNECTION WITH NATIONAL SEMICONDUCTOR CORPORATION ("NATIONAL") PRODUCTS. NATIONAL MAKES NO REPRESENTATIONS OR WARRANTIES WITH RESPECT TO THE ACCURACY OR COMPLETENESS OF THE CONTENTS OF THIS PUBLICATION AND RESERVES THE RIGHT TO MAKE CHANGES TO SPECIFICATIONS AND PRODUCT DESCRIPTIONS AT ANY TIME WITHOUT NOTICE. NO LICENSE, WHETHER EXPRESS, IMPLIED, ARISING BY ESTOPPEL OR OTHERWISE, TO ANY INTELLECTUAL PROPERTY RIGHTS IS GRANTED BY THIS DOCUMENT.

TESTING AND OTHER QUALITY CONTROLS ARE USED TO THE EXTENT NATIONAL DEEMS NECESSARY TO SUPPORT NATIONAL'S PRODUCT WARRANTY. EXCEPT WHERE MANDATED BY GOVERNMENT REQUIREMENTS, TESTING OF ALL PARAMETERS OF EACH PRODUCT IS NOT NECESSARILY PERFORMED. NATIONAL ASSUMES NO LIABILITY FOR APPLICATIONS ASSISTANCE OR BUYER PRODUCT DESIGN. BUYERS ARE RESPONSIBLE FOR THEIR PRODUCTS AND APPLICATIONS USING NATIONAL COMPONENTS. PRIOR TO USING OR DISTRIBUTING ANY PRODUCTS THAT INCLUDE NATIONAL COMPONENTS, BUYERS SHOULD PROVIDE ADEQUATE DESIGN, TESTING AND OPERATING SAFEGUARDS.

EXCEPT AS PROVIDED IN NATIONAL'S TERMS AND CONDITIONS OF SALE FOR SUCH PRODUCTS, NATIONAL ASSUMES NO LIABILITY WHATSOEVER, AND NATIONAL DISCLAIMS ANY EXPRESS OR IMPLIED WARRANTY RELATING TO THE SALE AND/OR USE OF NATIONAL PRODUCTS INCLUDING LIABILITY OR WARRANTIES RELATING TO FITNESS FOR A PARTICULAR PURPOSE, MERCHANTABILITY, OR INFRINGEMENT OF ANY PATENT, COPYRIGHT OR OTHER INTELLECTUAL PROPERTY RIGHT.

LIFE SUPPORT POLICY

NATIONAL'S PRODUCTS ARE NOT AUTHORIZED FOR USE AS CRITICAL COMPONENTS IN LIFE SUPPORT DEVICES OR SYSTEMS WITHOUT THE EXPRESS PRIOR WRITTEN APPROVAL OF THE CHIEF EXECUTIVE OFFICER AND GENERAL COUNSEL OF NATIONAL SEMICONDUCTOR CORPORATION. As used herein:

Life support devices or systems are devices which (a) are intended for surgical implant into the body, or (b) support or sustain life and whose failure to perform when properly used in accordance with instructions for use provided in the labeling can be reasonably expected to result in a significant injury to the user. A critical component is any component in a life support device or system whose failure to perform can be reasonably expected to cause the failure of the life support device or system or to affect its safety or effectiveness.

National Semiconductor and the National Semiconductor logo are registered trademarks of National Semiconductor Corporation. All other brand or product names may be trademarks or registered trademarks of their respective holders.

Copyright© 2009 National Semiconductor Corporation

For the most current product information visit us at www.national.com



National Semiconductor Americas Technical Support Center
Email: support@nsc.com
Tel: 1-800-272-9959

National Semiconductor Europe Technical Support Center
Email: europe.support@nsc.com
German Tel: +49 (0) 180 5010 771
English Tel: +44 (0) 870 850 4288

National Semiconductor Asia Pacific Technical Support Center
Email: ap.support@nsc.com

National Semiconductor Japan Technical Support Center
Email: jpn.feedback@nsc.com