

REFERENCE DESIGN

IRDCiP1206-B

International Rectifier • 233 Kansas Street, El Segundo, CA 90245 USA

IRDCiP1206-B: 300 kHz, Dual Output, Synchronous Buck Converter using iP1206



Overview

This reference design is capable of delivering a continuous current of 30A; (i.e. 15A max. per output channel) at an ambient temperature of 45°C and with 200LFM of airflow. Figures 1–24 provide performance graphs, thermal images, and waveforms. Figures 25–35, and Table 1 are provided to engineers as design references for implementing an iP1206 solution. The components installed on this demoboard were selected based on operation at an input voltage of 12V and at a switching frequency of 300 kHz. Changes from these set points may require optimizing the control loop and/or adjusting the values of input/output filters in order to meet the user's specific application requirements. Refer to the iP1206 datasheet User Design Guidelines section for more information.

Note: The 16-pin connector (CON1) is used only for production test purposes and should not be used for evaluation of this demoboard.



Demoboard Quick Start Guide

Initial Settings:

VOUT₁ is set to 2.5V, but can be adjusted from 0.8V to 5.5V by changing the values of R5 and R6 according to the following formula:

$$R5 = R6 = (10.0k * 0.8) / (VOUT - 0.8)$$

VOUT₂ is set to 1.5V, but can be adjusted from 0.8V to 5.5V by changing the values of R5 and R6 according to the following formula:

$$R15 = R16 = (10.0k * 0.8) / (VOUT - 0.8)$$

The switching frequency is set to 300 kHz, but can be adjusted by changing the value of R_T. The graph in Figure 26 shows the relationship between R_T and the switching frequency.

Power Up Procedure:

1. Apply input voltage across VIN and PGND.
2. Apply load across VOUT₁ pads and PGND pads and across VOUT₂ pads and PGND pads
3. Adjust load to desired level. See recommendations below.

Simultaneous and Ratiometric Startup and Shutdown:

Refer to the iP1206PbF datasheet for instructions on using the IRDCiP1206-B board outputs in either ratiometric or simultaneous operation mode.

IRDCiP1206-B Recommended Operating Conditions

(Refer to the iP1206 datasheet for maximum operating conditions)

Input voltage: 7.5V – 14.5V

Output voltage (VOUT₁, VOUT₂): 0.8 – 5.5V

Switching Freq: 300kHz

Output current: This reference design is capable of delivering a continuous current of 30A (15A per output channel) at an ambient temperature of 45°C with 200LFM of airflow (without heatsink).

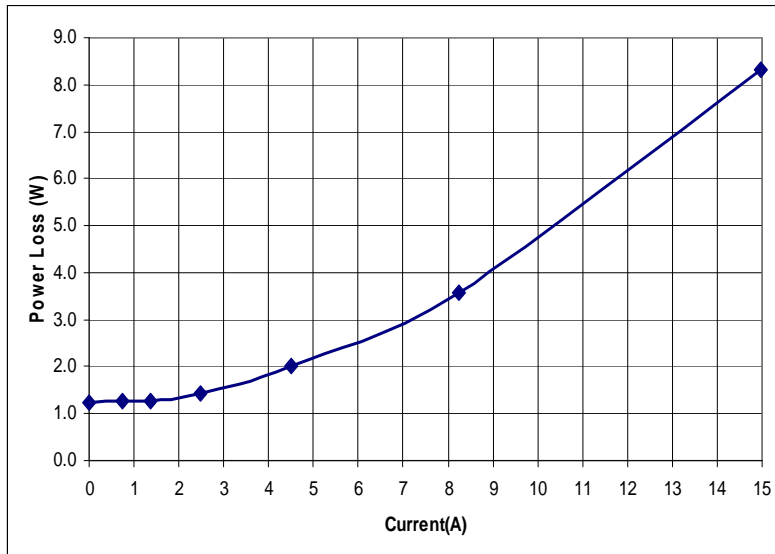

Fig. 1: Total System Power Loss vs. Output Current per phase

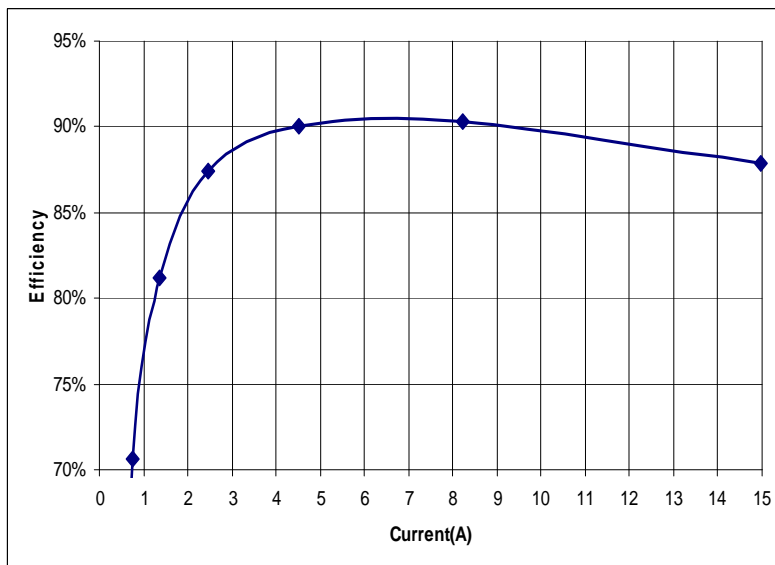

Fig. 2: Total System Efficiency vs. Output Current per phase

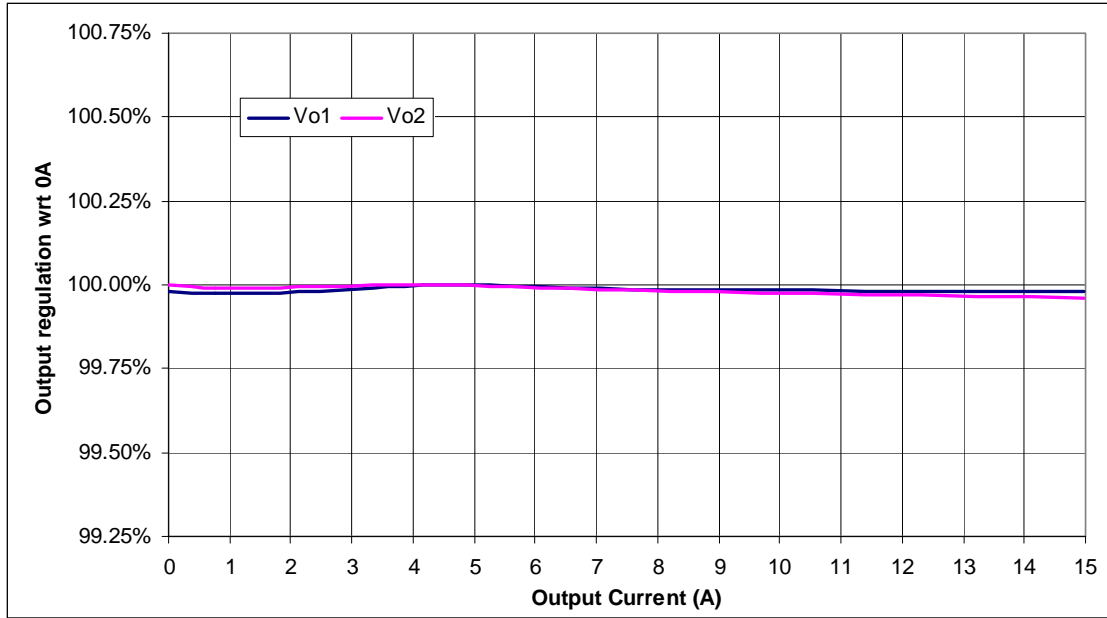

Fig. 3: Output Voltage Regulation vs. Current

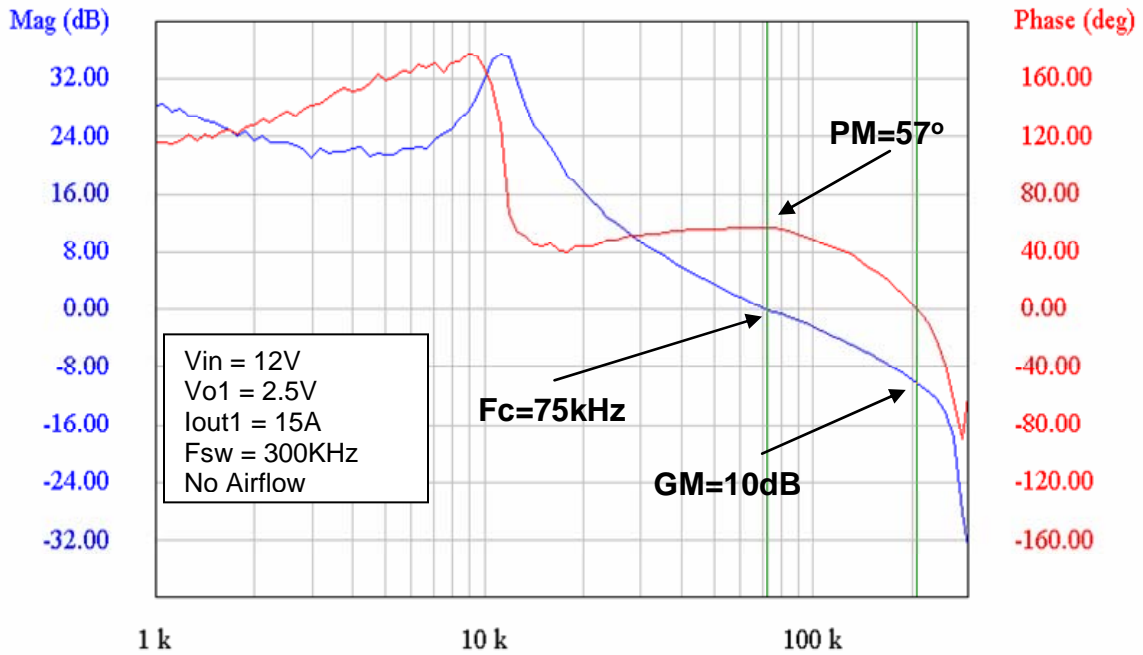

Fig. 4: Bode Plot of Vo1 (2.5V)

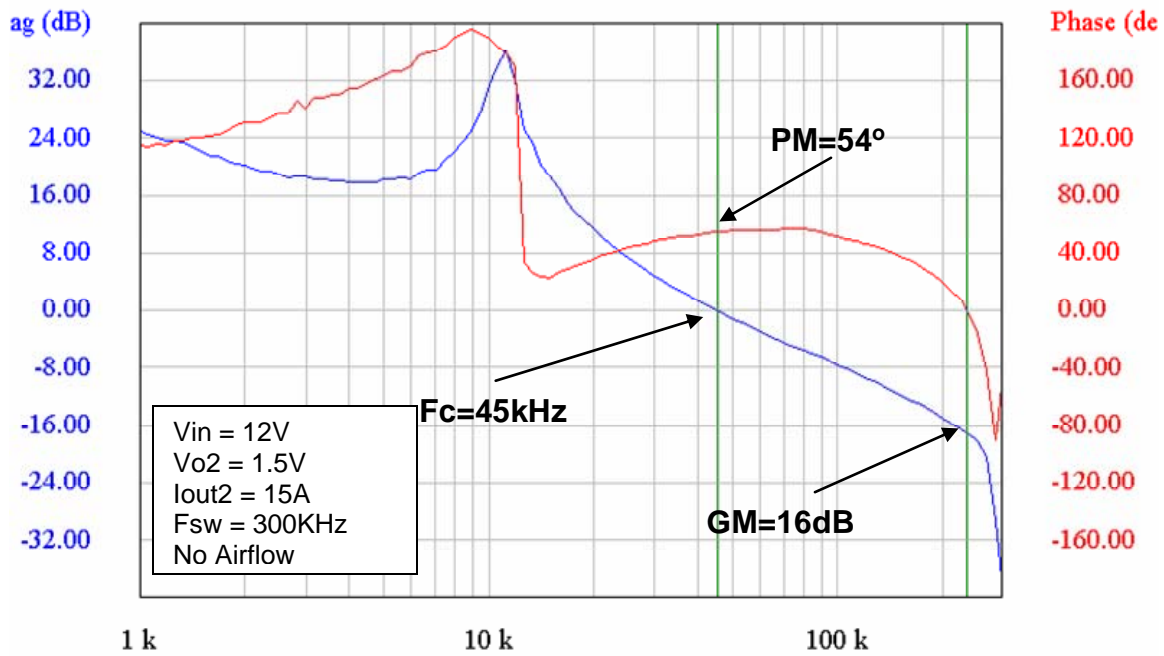
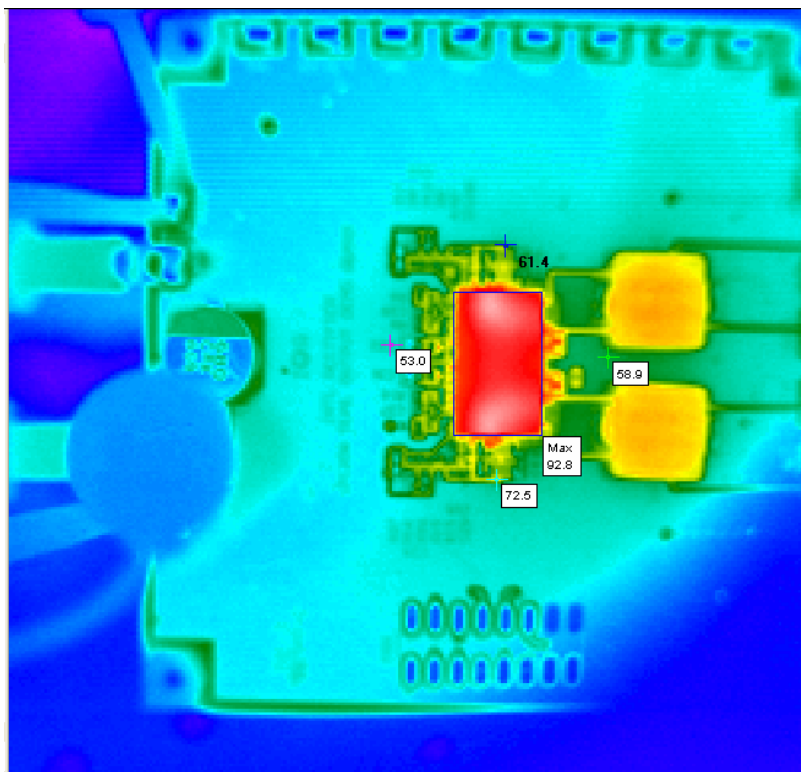

Fig. 5: Bode Plot of Vo2 (1.5V)



Conditions:
 Vin = 12V
 Vout1 = 2.5V
 Vout2 = 1.5V
 Iout1 = Iout2 = 15A
 Fsw = 300kHz
 Ambient Temp. = 45°C
 Airflow = 200LFM
 Stabilizing Time = 15 min

Fig. 6: Thermograph (No Heatsink)

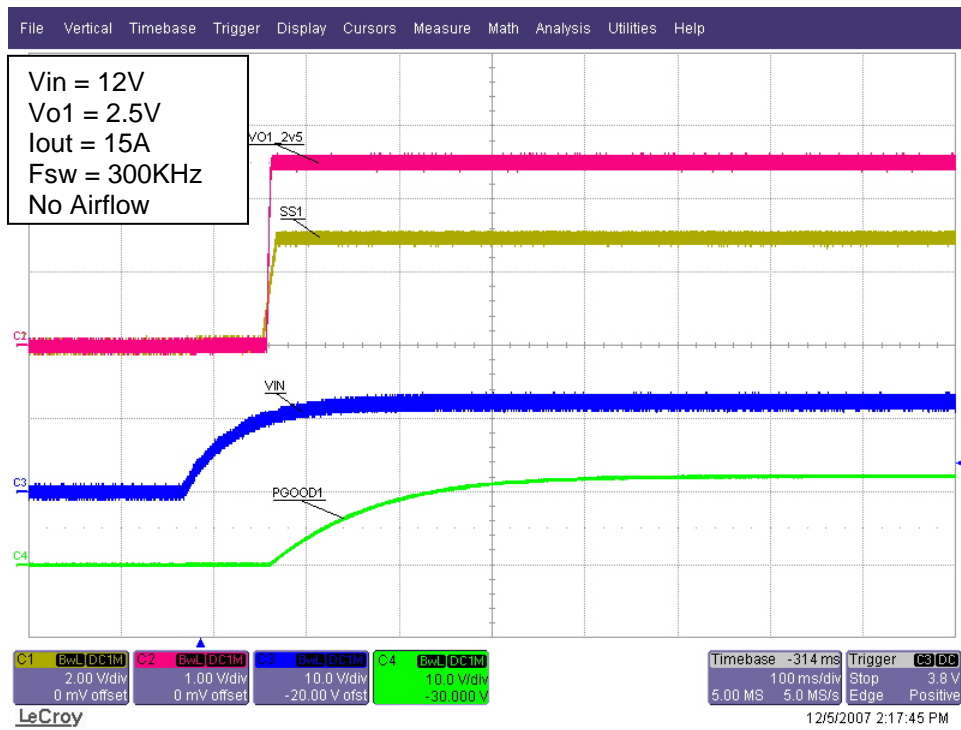

Fig.7: Vo1 Power Up Sequence

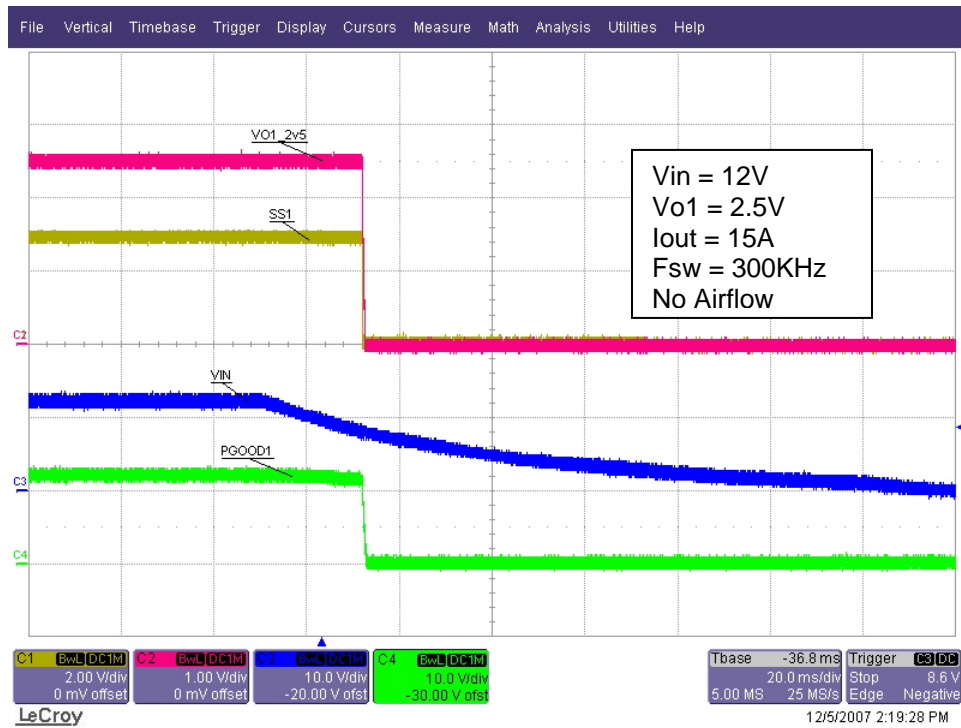

Fig. 8: Vo1 Power Down Sequence

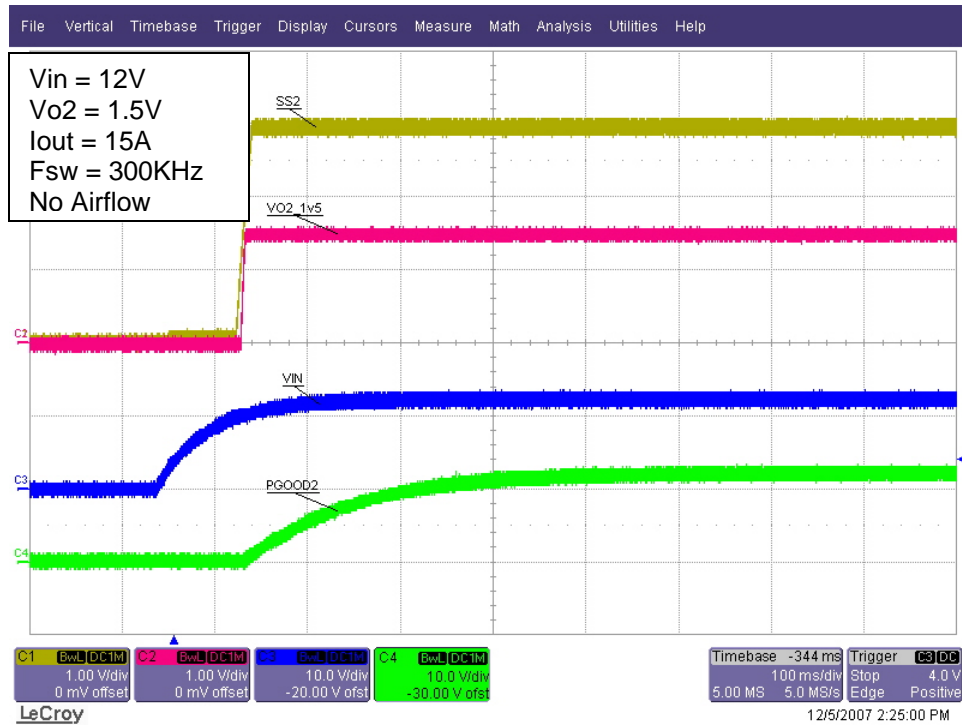

Fig.9: Vo2 Power Up Sequence

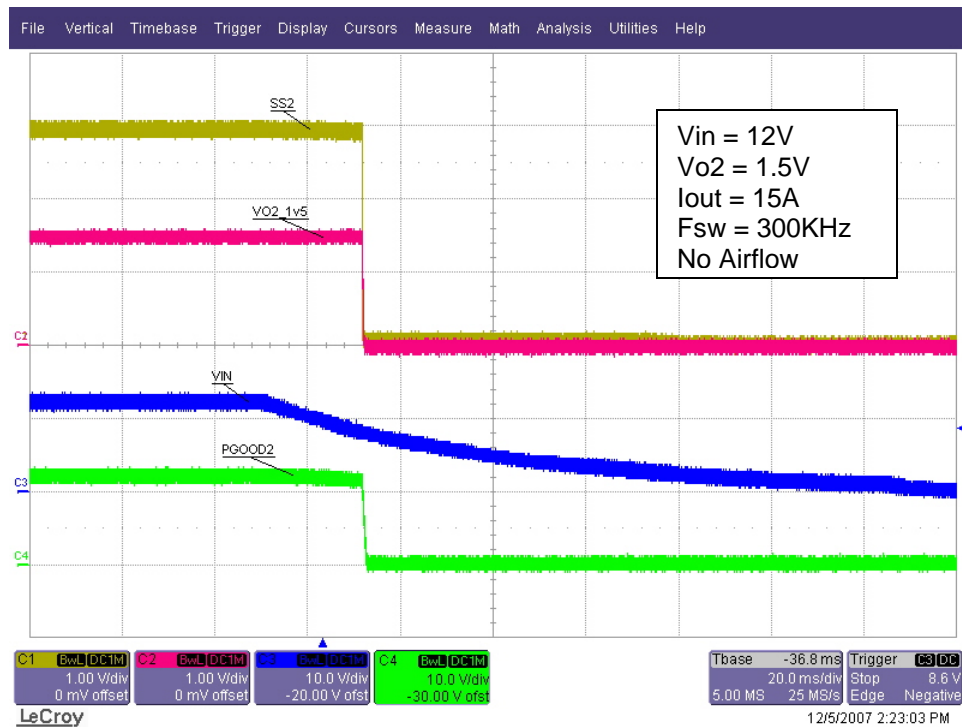

Fig.10: Vo2 Power Down Sequence

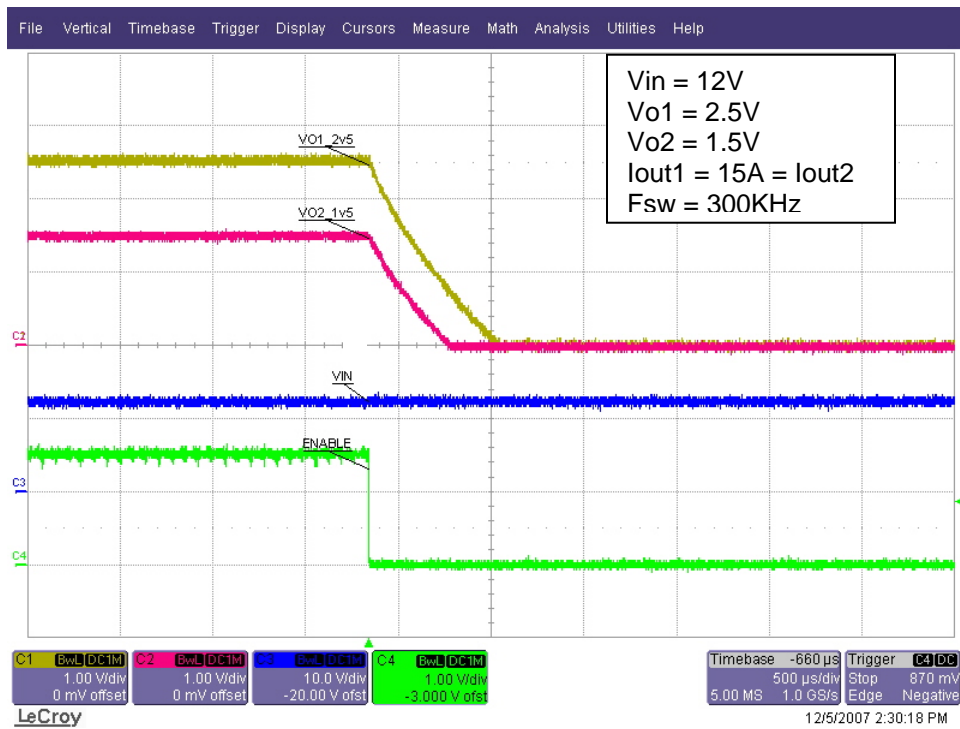

Fig. 11: Power Down when Enable is pulled low

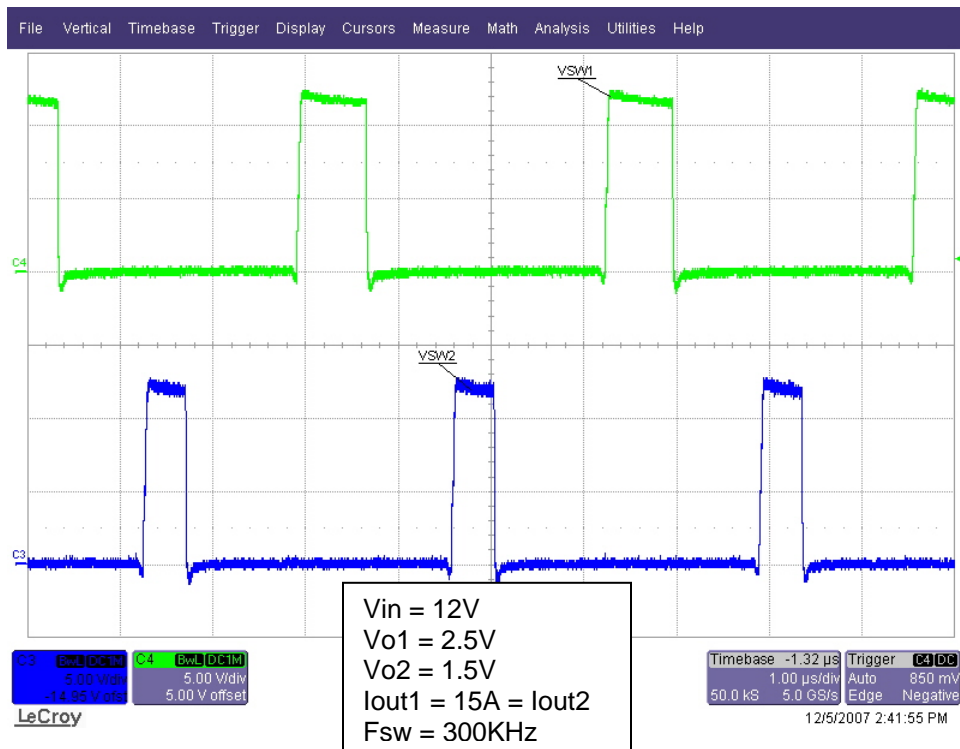

Fig. 12: Switch Node Waveforms

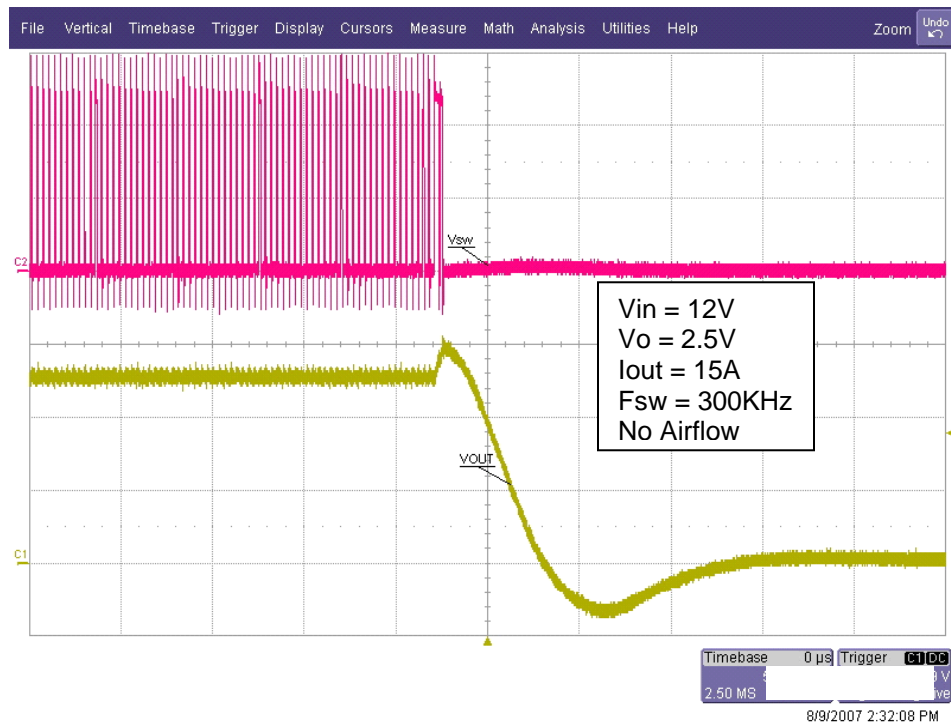

Fig. 13: Over Voltage Protection

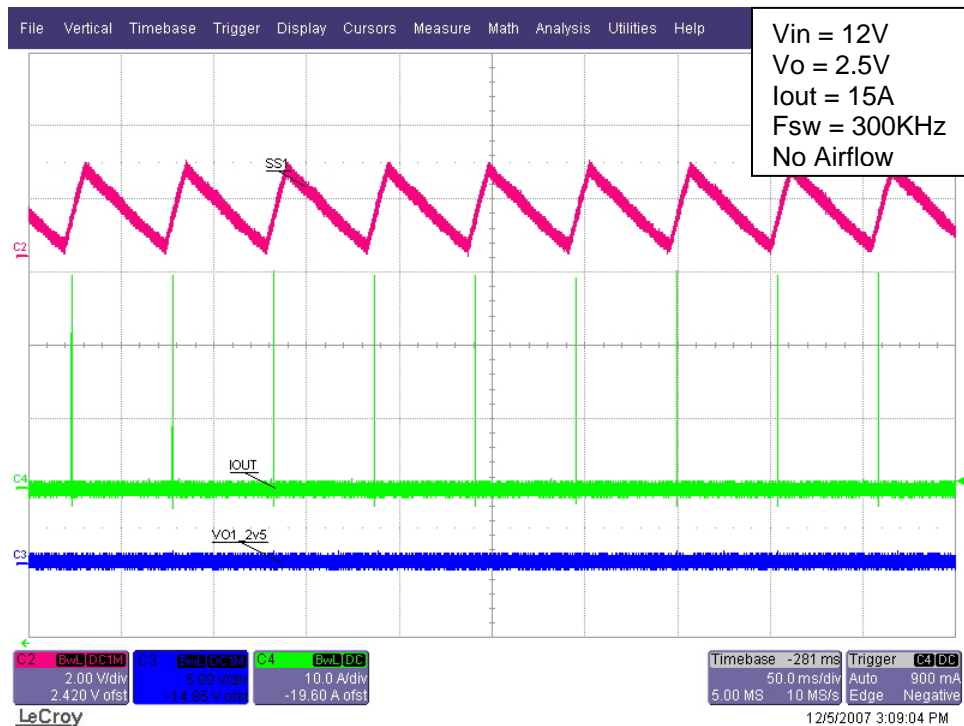

Fig. 14: Short Circuit Protection

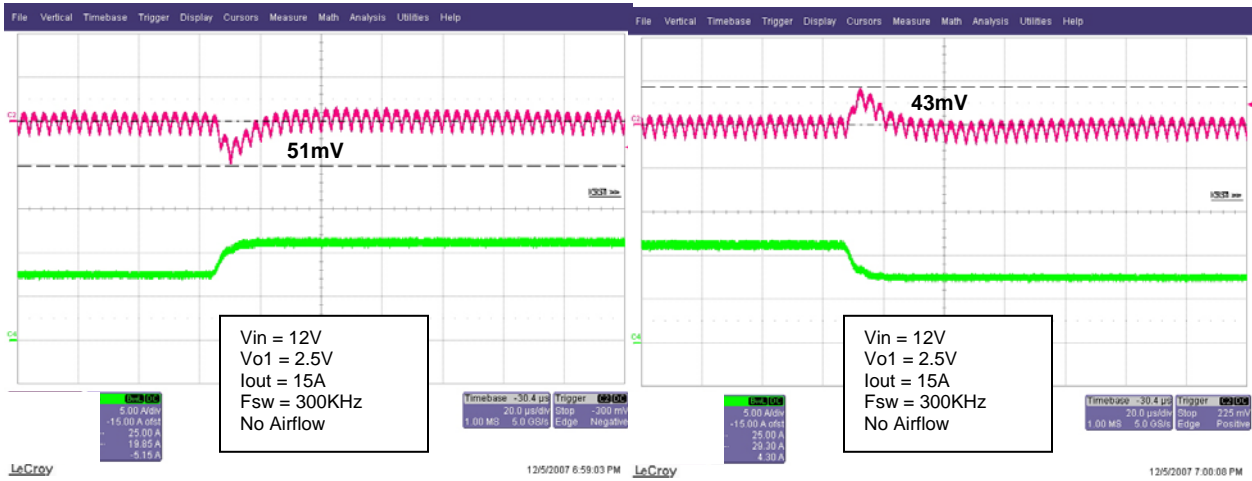

Fig. 15: I_{out1} Transient Step-Up 50% - 75%

Fig. 16: I_{out1} Transient Step-Down 75% - 50%

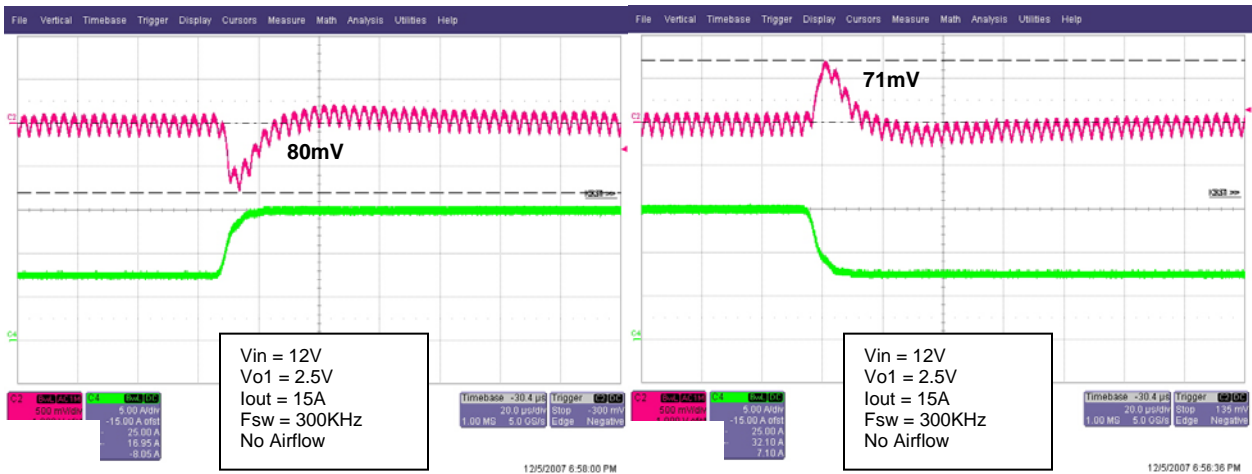

Fig. 17: I_{out1} Transient Step-Up 50% - 100%

Fig. 18: I_{out1} Transient Step-Down 100% - 50%

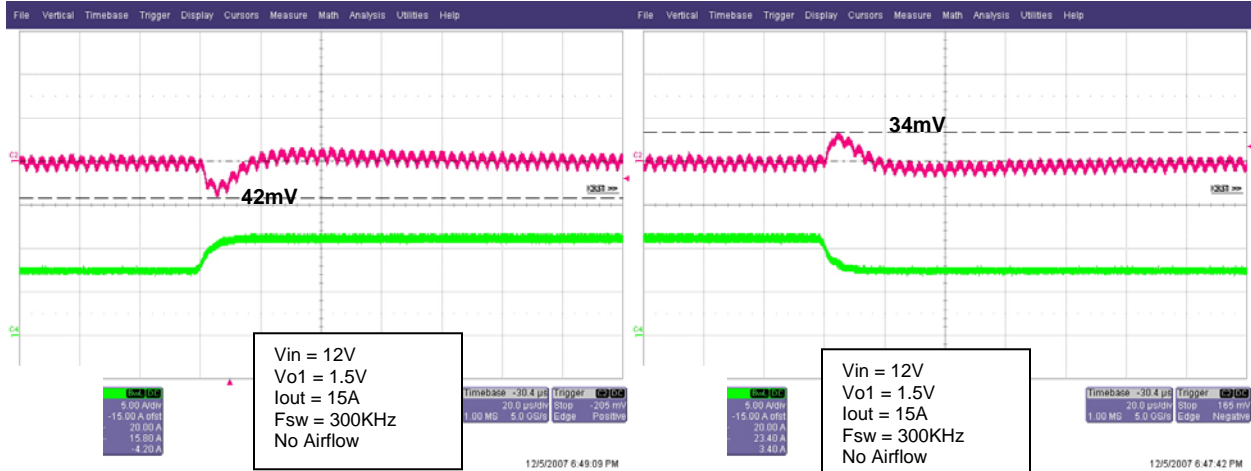

Fig. 19: I_{out2} Transient Step-Up 50% - 75%

Fig. 20: I_{out2} Transient Step-Down 75% - 50%

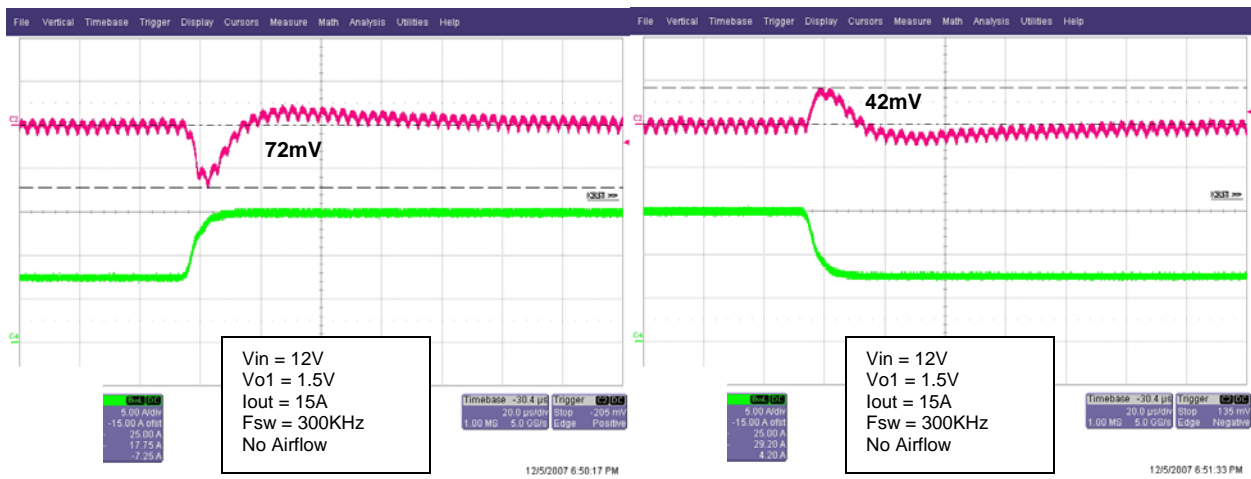

Fig. 21: I_{out2} Transient Step-Up 50% - 100%

Fig. 22: I_{out2} Transient Step-Down 100% - 50%

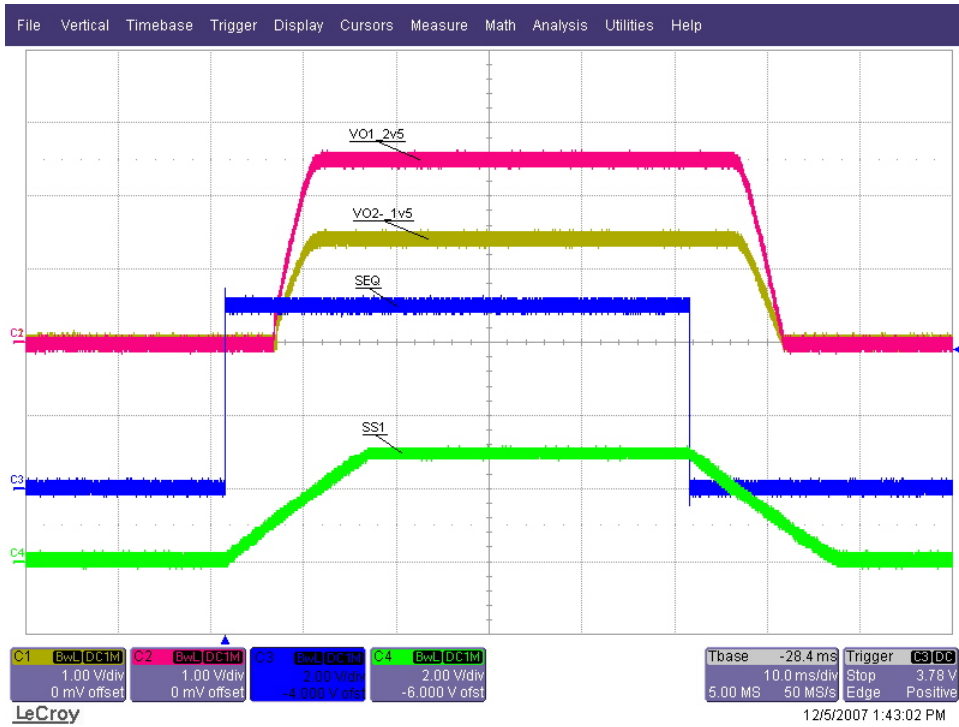

Fig. 23 Ratiometric Startup and Shutdown of Vo1 and Vo2

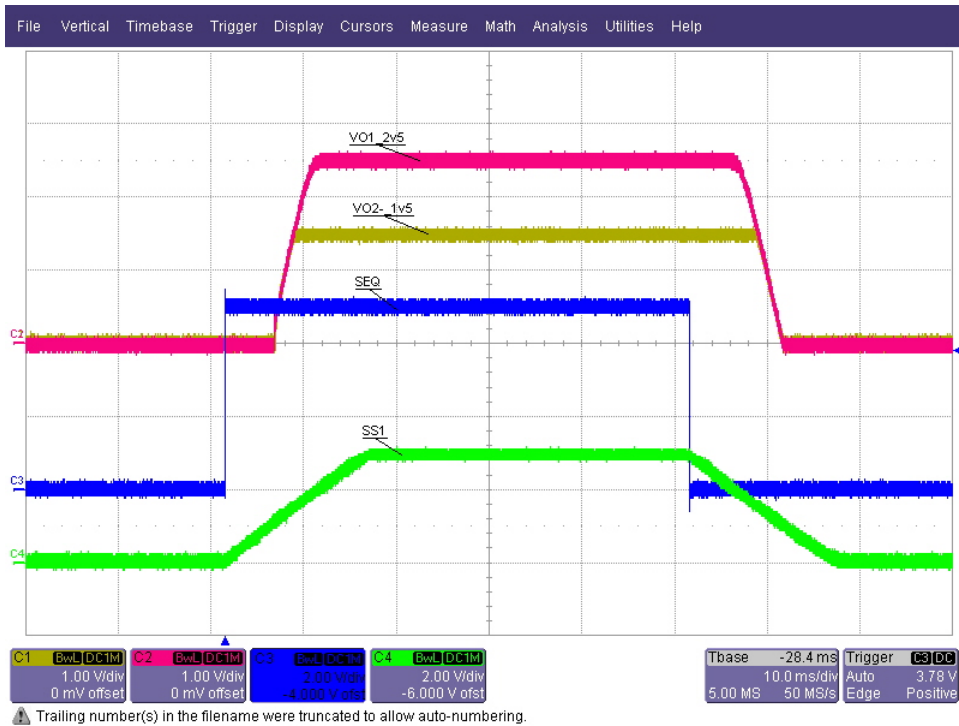

Fig. 24 Simultaneous Startup and Shutdown of Vo1 and Vo2

Adjusting the Over-Current Limit

ROC_x is the resistor used to adjust the over-current trip point. The trip point corresponds to the peak inductor current indicated on the x-axis of Fig. 21. (Note: The trip point will be higher than expected if the reference board is cool and is being used for short circuit testing.)

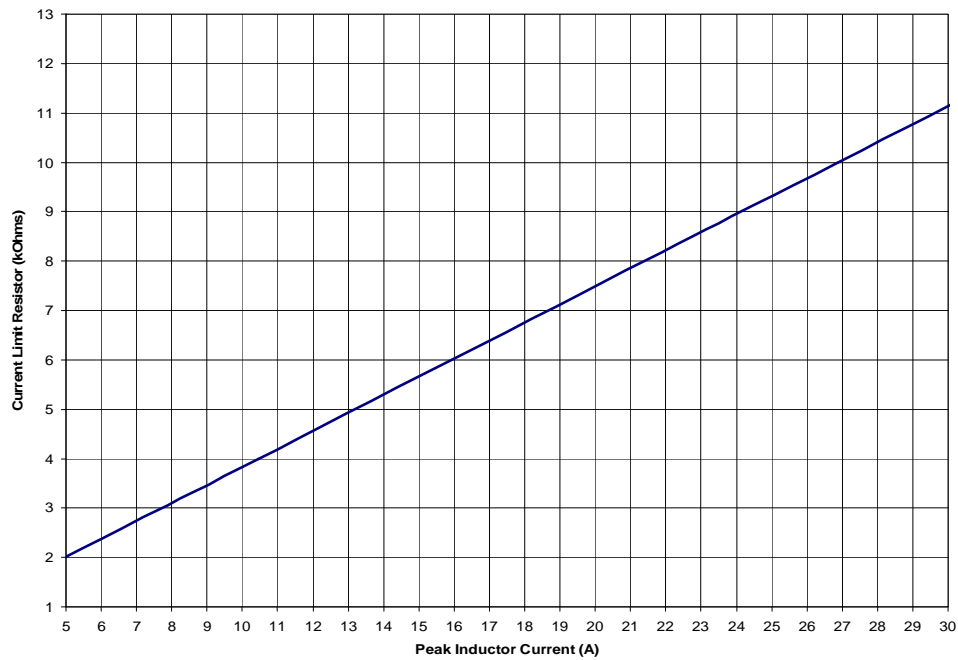

Fig. 25: R_{OCSET} vs. Over-Current Trip Point

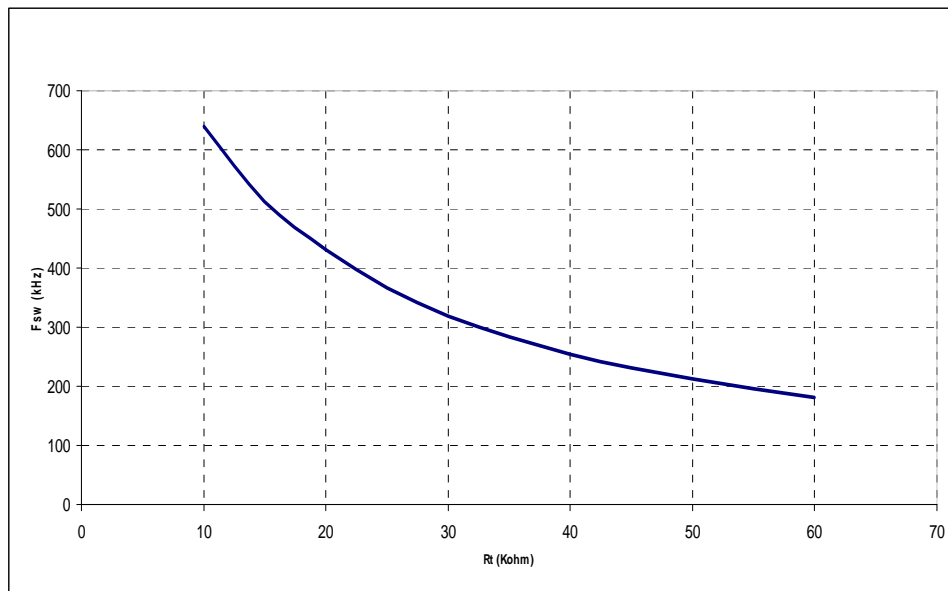

Fig. 26: R_T vs. Frequency

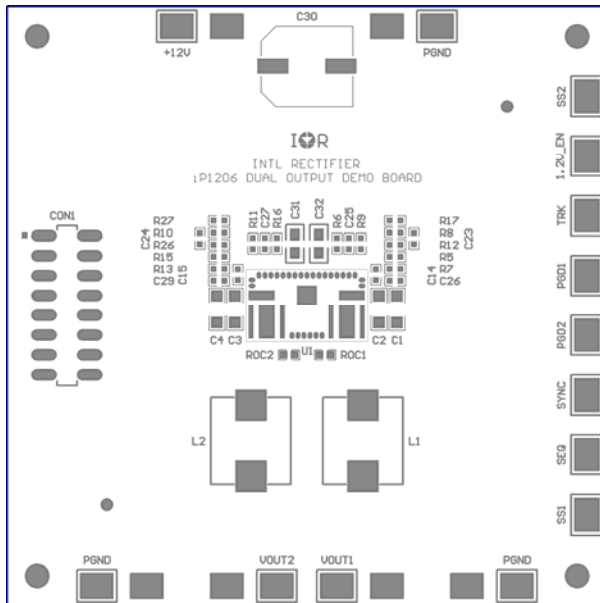

Fig. 27: Component Placement Top Layer

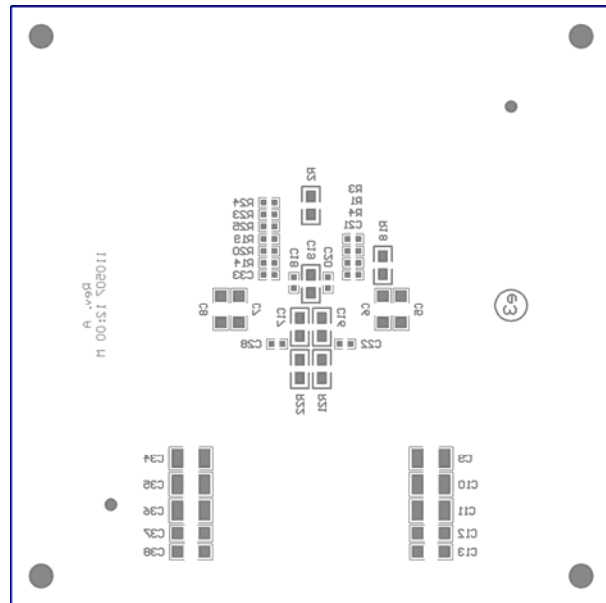

Fig. 28: Component Placement Bottom Layer

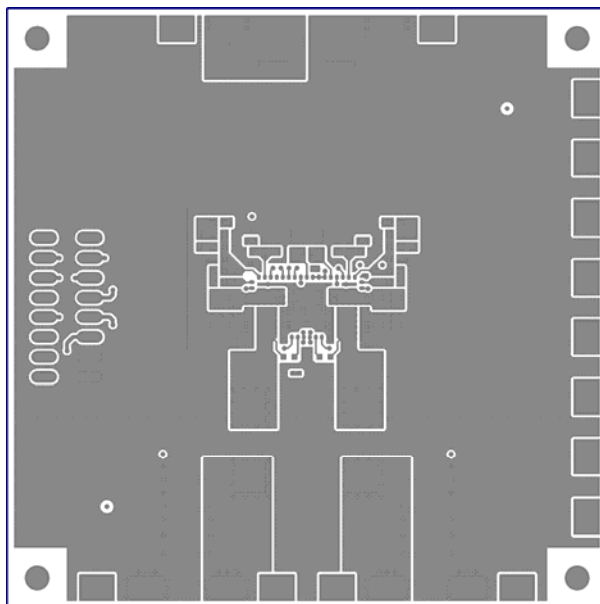

Fig. 29: Top Copper Layer

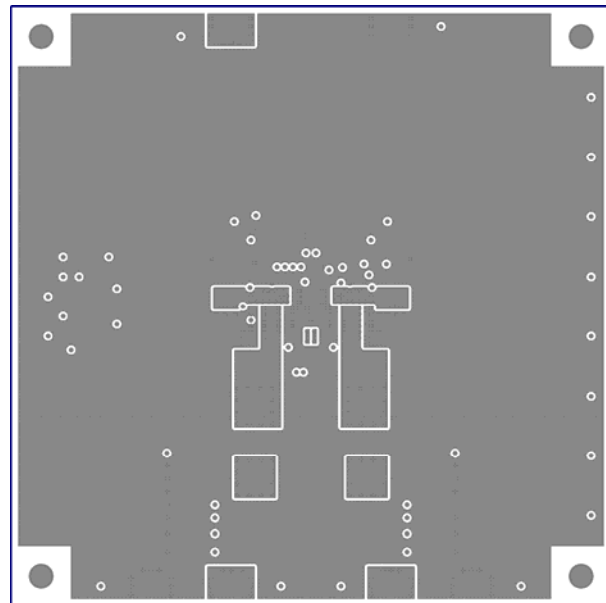

Fig. 30: 1st Mid Copper Layer

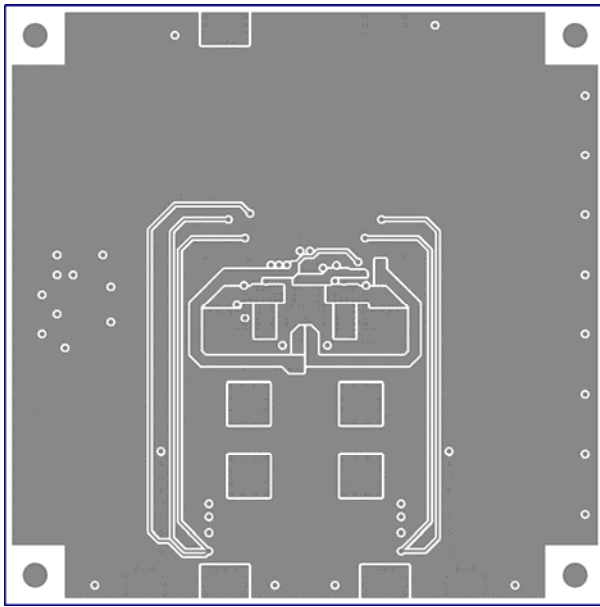

Fig. 31: 2nd Mid Copper Layer

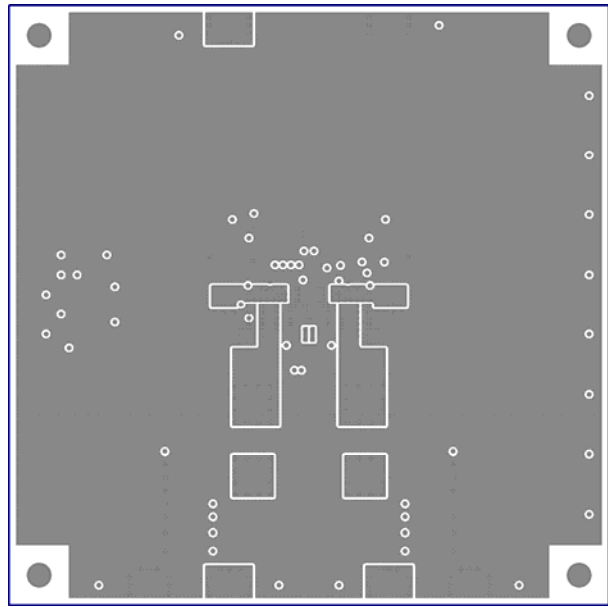

Fig. 32: 3rd Mid Copper Layer

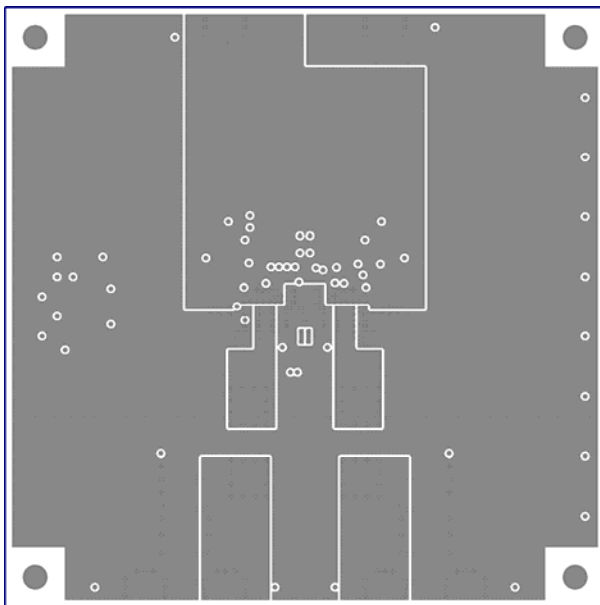

Fig. 33: 4th Mid Copper Layer

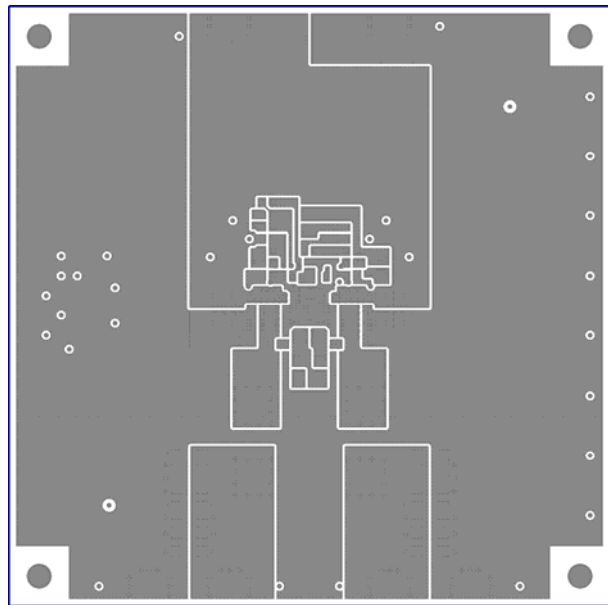

Fig. 34: Bottom Copper Layer

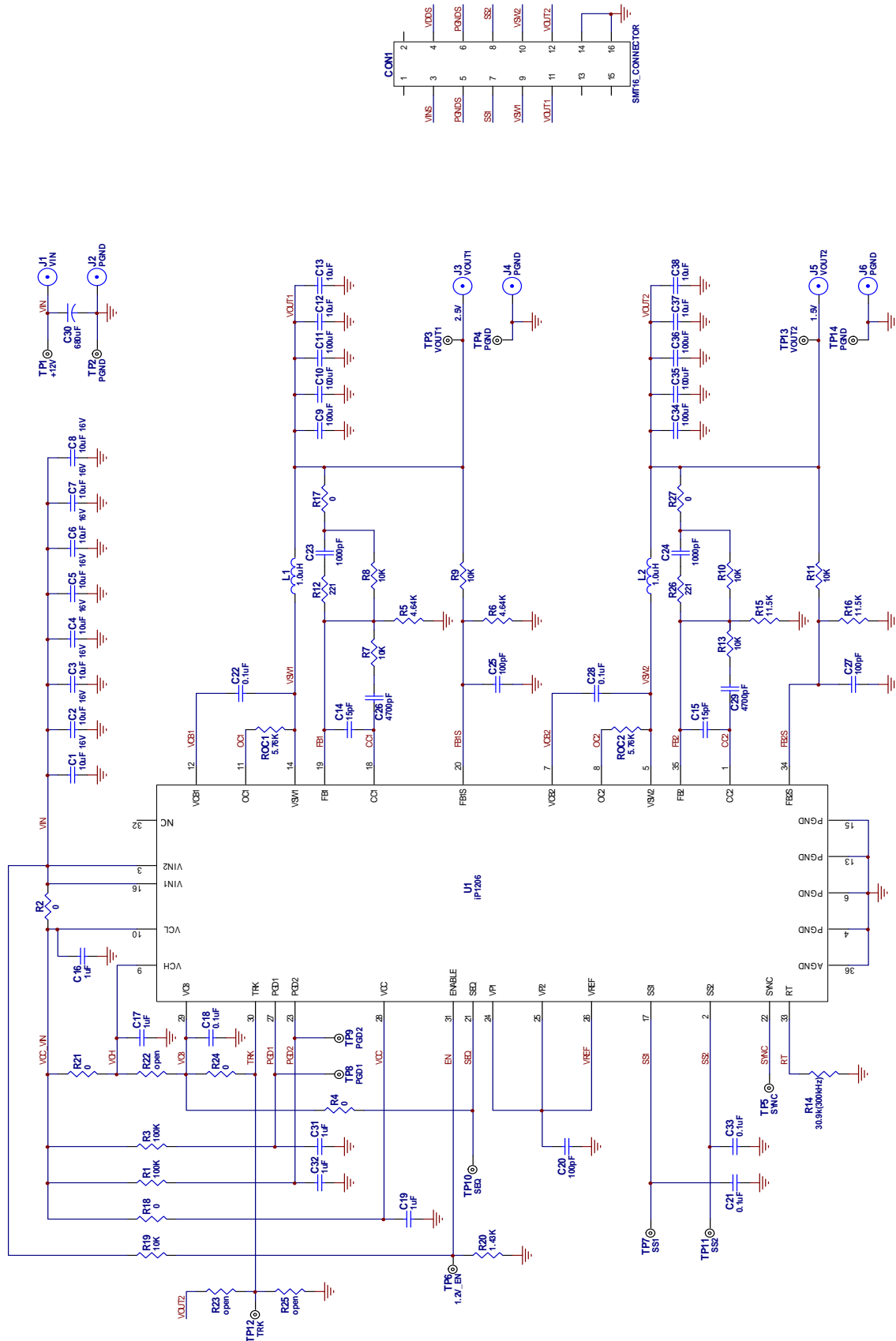

Fig. 35: Schematic of the Reference design

Quantity	Designator	Type 1	Type 2	Value 1	Value 2	Tolerance	Package	Manufac 1	Manufac 1No
12	C1, C2, C3, C4, C5, C6, C7, C8, C12, C13, C37, C38	capacitor	X7R	10.0uF	16V	10%	1206	TDK	C3216X7R1C106KT
6	C9, C10, C11, C34, C35, C36	capacitor	X5R	100uF	6.3V	20%	1210	TDK	C3225X5R0J107M
2	C14, C15	capacitor	NPO	15.0pF	50V	5%	0603	KOA	NPO0603HTTD150J
5	C16, C17, C19, C31, C32	capacitor	X7R	1.00uF	16V	10%	0805	MuRata	GRM40X7R105K016
5	C18, C21, C22, C28, C33	capacitor	X7R	0.100uF	16V	10%	0603	MuRata	GRM188R71C104K401D
3	C20, C25, C27	capacitor	NPO	100pF	50V	5%	0603	Phycomp	0603CG101J9B20
2	C23, C24	capacitor	X7R	1000pF	50V	10%	0603	BC Component	0603B102K500NT
2	C26, C29	capacitor	X7R	4700pF	50V	10%	0603	Phicomp	06032R472K9B20
1	C30	capacitor	electrolytic	680uF	16V	20%	SMD	Panasonic	EEV-FK10681GP
2	L1, L2	inductor	ferrite	1.00uH	25A	20%	SMT	Delta Electronics	MPL105-1R0IR
2	R1, R3	resistor	thick film	100K	1/10W	1%	0603	KOA	RK73H1J1003F
7	R7, R8, R9, R10, R11, R13, R19	resistor	thick film	10.0K	1/10W	1%	0603	KOA	RK73H1J1002F
2	R12, R26	resistor	thick film	221	1/10W	1%	0603	KOA	RK73H1JLTD2210F
1	R14	resistor	thick film	30.9K	1/10W	1%	0603	KOA	RK73H1J3092F
2	R15, R16	resistor	thick film	11.5K	1/10W	1%	0603	KOA	RK73H1JLTD1152F
4	R4, R17, R24, R27	resistor	thick film	0	1/10W	1%	0603	KOA	RK73Z1JLTD
3	R2, R18, R22	resistor	thick film	0	1/8W	<50m	0805	ROHM	MCR10EZJ000
1	R20	resistor	thick film	1.43K	1/10W	1%	0603	KOA	RK73H1JLTD1431F
2	R5, R6	resistor	thick film	4.64K	1/10W	1%	0603	KOA	RK73H1JLTD4641F
2	ROC1, ROC2	resistor	thick film	5.76K	1/10W	1%	0603	KOA	RK73H1JLTD5761F
14	+12V, 1.2V_EN, PGD1, PGD2, PGND, PGND, PGND, PGND, SEQ, SS1, SS2, SYNC, TRK, VOUT1, VOUT2	hardware	test point	90 mils	112 x 150 mils	-	SMT	Keystone	5016
1	U1	iP1206	LGA unit	rev-b	-	-	9.25 x 15.5mm	IRF	rev-b
	*Red - Top Side Components								
	*Blue - Bottom Side Components								

Table 1: Bill of Materials for the Reference design

Refer to the following application notes for detailed guidelines and suggestions when implementing iPOWIR Technology products:

AN-1028: Recommended Design, Integration and Rework Guidelines for International Rectifier's iPowIR Technology BGA and LGA and Packages

This paper discusses optimization of the layout design for mounting iPowIR BGA and LGA packages on printed circuit boards, accounting for thermal and electrical performance and assembly considerations. Topics discussed includes PCB layout placement, and via interconnect suggestions, as well as soldering, pick and place, reflow, inspection, cleaning and reworking recommendations.

AN-1030: Applying iPOWIR Products in Your Thermal Environment

This paper explains how to use the Power Loss and SOA curves in the data sheet to validate if the operating conditions and thermal environment are within the Safe Operating Area of the iPOWIR product.

AN-1047: Graphical solution for two branch heatsinking Safe Operating Area

Detailed explanation of the dual axis SOA graph and how it is derived.

Use of this design for any application should be fully verified by the customer. International Rectifier cannot guarantee suitability for your applications, and is not liable for any result of usage for such applications including, without limitation, personal or property damage or violation of third party intellectual property rights.

IR WORLD HEADQUARTERS: 233 Kansas St., El Segundo, California 90245, USA Tel: (310) 252-7105
TAC Fax: (310) 252-7903