

REFERENCE DESIGN

IRDCiP1201-A

International Rectifier • 233 Kansas Street, El Segundo, CA 90245 USA

IRDCiP1201-A, 300kHz, Dual 15A, 3.14V_{IN} to 5.5V_{IN} Dual Output Synchronous Buck Converter using iP1201

Overview

The iP1201 is fully optimized solution for medium current synchronous buck applications requiring up to 15A or 30A. In this document, Fig. 1, 2, 3 and 4 are provided to enable engineers to easily evaluate the iP1201 in an independent and parallel configuration that is capable of providing up to 15A per phase with double-sided heat sinking. Fig. 6, 7 and 8 and the complete bill of materials in Table 1 are provided as a reference design to enable engineers to very quickly and easily design a dual phase converter. In order to optimize this design to your specific requirements, refer to the iP1201 data sheet for guidelines on external component selection and user adjustable limits and specifications. Custom designs may require layout modifications.

iPOWER™
 TECHNOLOGY



Demoboard Quick Start Guide

Initial Settings:

- The output1 is set to 1.5V and output2 is set to 2.5V for independent configuration.
- The output1 is set to 1.5V with R8, R10, R11 and R12 removed for parallel configuration.
- Output can be adjusted from 0.8V to 3.3V as follow:
 1. V_{OUT1}: R9=R13= R7 [(V_{OUT1} / Vref) – 1]. Set R7=R14=1k, Vref=0.8V
 2. V_{OUT2}: R10=R11= R8 [(V_{OUT2} / Vref) – 1]. Set R8=R12=1k, Vref=0.8V.
- The switching frequency is set to R3=30.9k for 300kHz
- The input voltage range can be increased to allow operation between 3.14V_{IN} and 5.5V_{IN}.
- For paralleled single output operation see Fig. 6 for configuration table in reference design schematic.

Procedure for Connecting and Powering Up Demoboard:

1. Connected JP2 for V_{IN} < 3.5V.
2. Disconnected JP2 for V_{IN} > 3.5V.
3. Make sure JP3 is connected
4. Apply input voltage (3.14V-5.5V) across V_{IN} and PGND
5. Apply load across VOUT1 pad and PGND pad and VOUT2 pad and PGND pad for independent configuration.
6. Apply load across VOUT1 pad and PGND pad and short R23 for parallel configuration.
7. Adjust load accordingly.

IRDCiP1201-A Recommended Operating Conditions

(refer to the iP1201 datasheet for maximum operating conditions)

Input voltage: 3.14 - 5.5V

Output voltage: Can be set between 0.8V – 3.3V, up to 90% max duty cycle.

Output current: Up to 15A (see recommended operating area Fig. 1, 2 and 3). The maximum current should be limited to 11.5A if the PCB is the only heat sink.

Switching Freq: 200kHz to 400kHz selectable.

08/18/03

IRDCiP1201-A

International
IR Rectifier

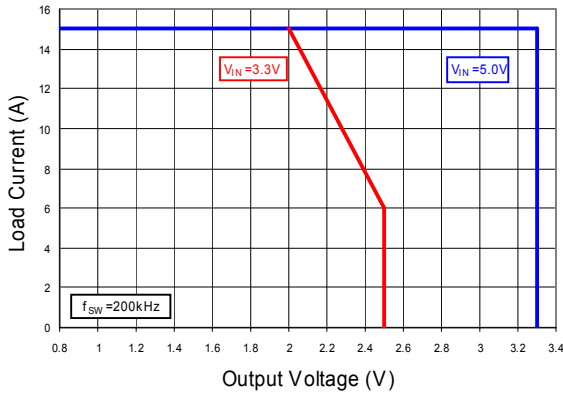

Fig. 1: Recommended Operating Area
200kHz

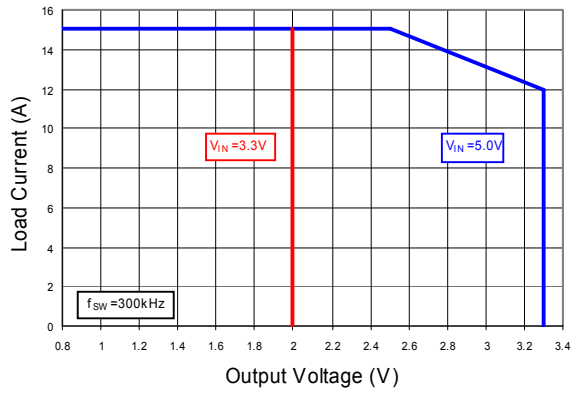

Fig. 2: Recommended Operating Area
300kHz

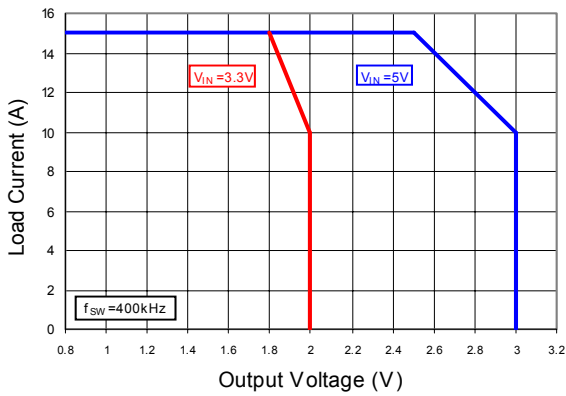

Fig. 3: Recommended Operating Area
400kHz

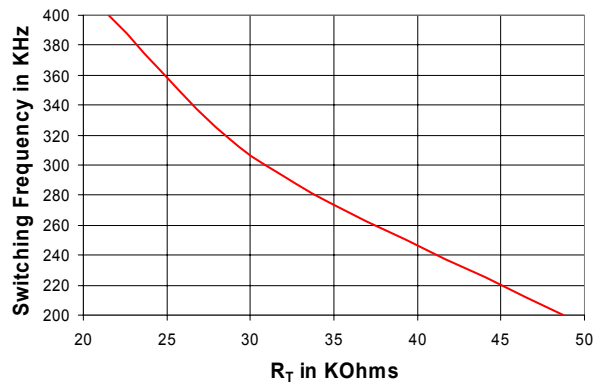

Fig. 4 : Per Channel Switching Frequency vs R_T

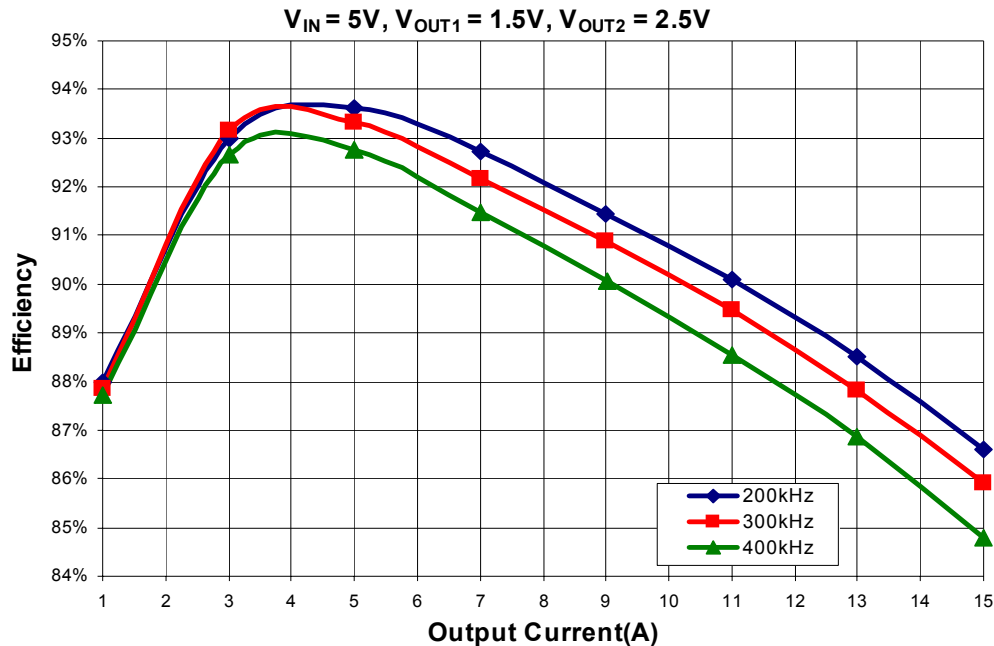

Fig. 5 - Typical Efficiency vs. Current

For output current greater than 11A per channel, PCB and device case temperature will need to remain within the SOA of the iP1201. See iP1201 datasheet and AN-1047.

Refer to the following application notes for detailed guidelines and suggestions when implementing iPOWIR Technology products:

AN-1028: Recommended Design, Integration and Rework Guidelines for International Rectifier's iPOWIR Technology BGA Packages

This paper discusses the assembly considerations that need to be taken when mounting iPOWIR BGA's on printed circuit boards. This includes soldering, pick and place, reflow, inspection, cleaning and reworking recommendations.

AN-1029: Optimizing a PCB Layout for an iPOWIR Technology Design

This paper describes how to optimize the PCB layout design for both thermal and electrical performance. This includes placement, routing, and via interconnect suggestions.

AN-1030: Applying iPOWIR Products in Your Thermal Environment

This paper explains how to use the Power Loss and SOA curves in the data sheet to validate if the operating conditions and thermal environment are within the Safe Operating Area of the iPOWIR product.

AN-1047: Graphical solution to two branch heatsinking Safe Operating Area

This paper is a supplement to AN-1030 and explains how to use the double side Power Loss and SOA curves in the data sheet to validate if the operating conditions and thermal environment are within the Safe Operating Area of the iPOWIR product.

IRDCiP1201-A

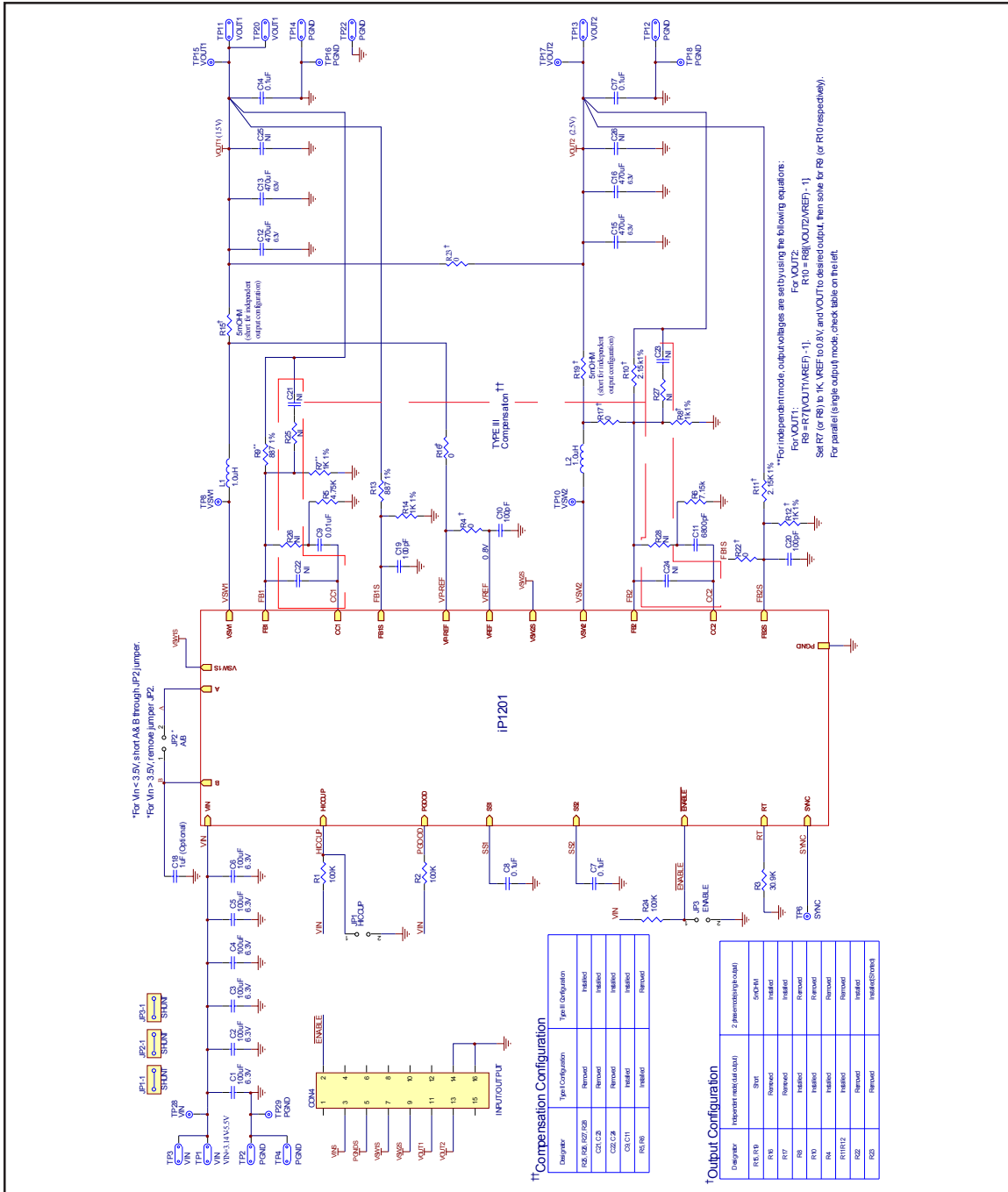

Fig. 6 - Reference Design Schematic

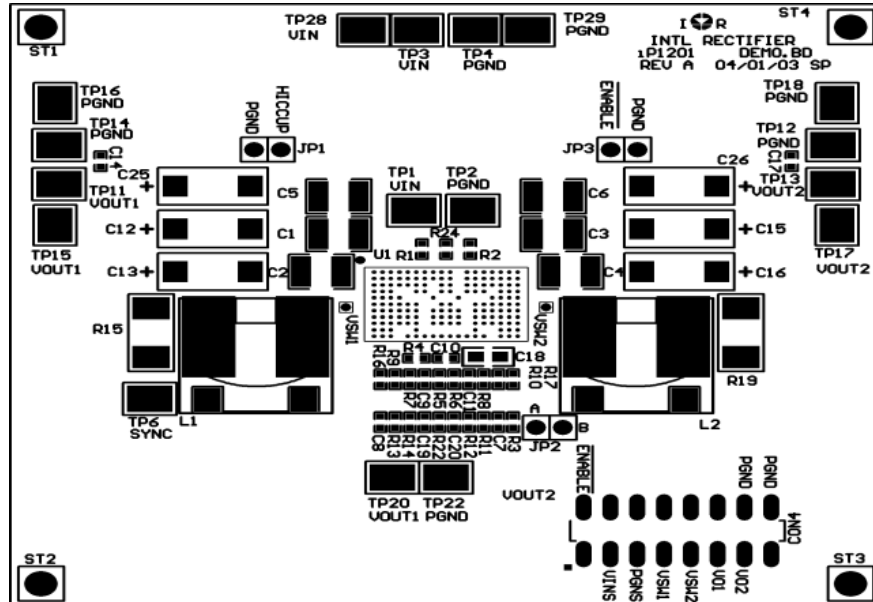

Fig. 7 - Component Placement (Top View) SideLayer

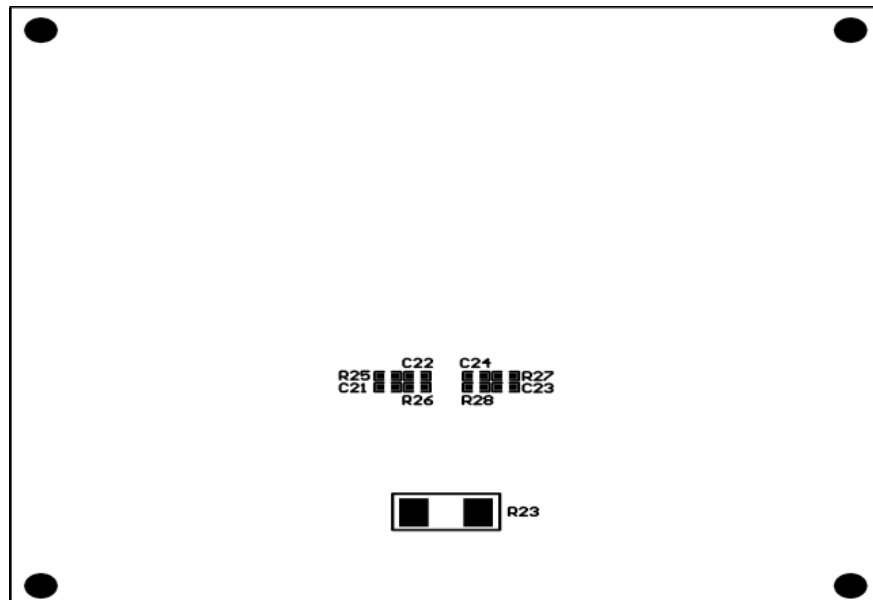

Fig. 8 - Component Placement (Bottom View)

IRDCiP1201-A



IRDCiP1201-A (Dual, Independent output configurations(Channel1 1.5V output, Channel2 2.5V output))

QTY	REF DESIGNATOR	DESCRIPTION	SIZE	MFR	PART NUMBER
6	C1, C2, C3, C4, C5, C6	Capacitor, ceramic, 100µF, 6.3V, X5R, 20%	1812	TDK	C4532X5R0J107M
3	C10, C19, C20	Capacitor, ceramic, 100pF, 50V, NPO, 5%	0603	Phycomp	0603CG101J9B20
1	C11	Capacitor, ceramic, 6800pF, 50V, X7R, 10%	0603	KOA	X7R0603HTTD682K
4	C12, C13, C15, C16	Capacitor, poscap, 470µF, 6.3V, electrolytic 20%	7343	Sanyo	6TPB470M
4	C14, C17, C7, C8	Capacitor, ceramic, 0.1µF, 16V, X7R, 10%	0603	Murata	GRM188R71C104KA01D
1	C18	Capacitor, ceramic, 1.00µF, 16V, X7R, 10%	0805	Murata	GRM40X7R105K016
14	C21, C22, C23, C24, C25, C26, R16, R17, R22, R23, R25, R26, R27, R28	Not installed	-	-	-
1	C9	Capacitor, ceramic, 0.01µF, 50V, X7R, 10%	0603	Samsung	CL10B103KBNC
2	L1, L2	Inductor, 1µH, 19A, 20%	13.0mm X 12.9mm	Panasonic	ETQP1H1R0BFA
3	R1, R2, R24	Resistor, thick film, 100kΩ, 1/10W, 1%	0603	KOA	RK73H1J1003F
2	R10, R11	Resistor, thick film, 2.15kΩ, 1/10W, 1%	0603	KOA	RK73H1J2151F
4	R12, R14, R7, R8	Resistor, thick film, 1.0kΩ, 1/10W, 1%	0603	KOA	RK73H1J1001F
2	R13, R9	Resistor, thick film, 887Ω, 1/10W, 1%	0603	KOA	RK73H1J8870F
2	R15, R19	Resistor, manganin-foil, 0Ω, 2W	2716	Isotek Corp	SMT-R000
1	R3	Resistor, thick film, 30.9kΩ, 1/10W, 1%	0603	KOA	RK73H1J3092F
1	R4	Resistor, thick film, 0Ω, 1/10W	0603	ROHM	MCR03EZJH000
1	R5	Resistor, thick film, 4.75kΩ, 1/10W, 1%	0603	KOA	RK73H1JLTD4751F
1	R6	Resistor, thick film, 7.15kΩ, 1/10W, 1%	0603	KOA	RK73H1JLTD7151F
1	U1	BGA Power Block	9.25mm X 15.5mm	IR	iP1201

IRDCiP1201-A (Single, paralleled output configuration(for 1.5V output))

QTY	REF DESIGNATOR	DESCRIPTION	SIZE	MFR	PART NUMBER
6	C1, C2, C3, C4, C5, C6	Capacitor, ceramic, 100µF, 6.3V, X5R, 20%	1812	TDK	C4532X5R0J107M
3	C10, C19, C20	Capacitor, ceramic, 100pF, 50V, NPO, 5%	0603	Phycomp	0603CG101J9B20
1	C11	Capacitor, ceramic, 6800pF, 50V, X7R, 10%	0603	KOA	X7R0603HTTD682K
4	C12, C13, C15, C16	Capacitor, poscap, 470µF, 6.3V, electrolytic 20%	7343	Sanyo	6TPB470M
4	C14, C17, C7, C8	Capacitor, ceramic, 0.1µF, 16V, X7R, 10%	0603	Murata	GRM188R71C104KA01D
1	C18	Capacitor, ceramic, 1.00µF, 16V, X7R, 10%	0805	Murata	GRM40X7R105K016
15	C21, C22, C23, C24, C25, C26, R10, R11, R12, R25, R26, R27, R28, R4, R8	Not installed	-	-	-
1	C9	Capacitor, ceramic, 0.01µF, 50V, X7R, 10%	0603	Samsung	CL10B103KBNC
2	L1, L2	Inductor, 1µH, 19A, 20%	13.0mm X 12.9mm	Panasonic	ETQP1H1R0BFA
3	R1, R2, R24	Resistor, thick film, 100kΩ, 1/10W, 1%	0603	KOA	RK73H1J1003F
2	R14, R7	Resistor, thick film, 1.0kΩ, 1/10W, 1%	0603	KOA	RK73H1J1001F
2	R13, R9	Resistor, thick film, 887Ω, 1/10W, 1%	0603	KOA	RK73H1J8870F
2	R15, R19	Resistor, alloy metal, 5mΩ, 1W, 1%	2512	Panasonic	ERJM1WSF5M0U
1	R23	Resistor, manganin-foil, 0Ω, 2W	2716	Isotek Corp	SMT-R000
1	R3	Resistor, thick film, 30.9kΩ, 1/10W, 1%	0603	KOA	RK73H1J3092F
3	R16, R17, R22	Resistor, thick film, 0Ω, 1/10W	0603	ROHM	MCR03EZJH000
1	R5	Resistor, thick film, 4.75kΩ, 1/10W, 1%	0603	KOA	RK73H1JLTD4751F
1	R6	Resistor, thick film, 7.15kΩ, 1/10W, 1%	0603	KOA	RK73H1JLTD7151F
1	U1	BGA Power Block	9.25mm X 15.5mm	IR	iP1201

Table 1 - Reference Design Bill of Materials

Use of this design for any application should be fully verified by the customer. International Rectifier cannot guarantee suitability for your applications, and is not liable for any result of usage for such applications including, without limitation, personal or property damage or violation of third party intellectual property rights.

IR WORLD HEADQUARTERS: 233 Kansas St., El Segundo, California 90245, USA Tel: ++ 1 310 252 7105
 Technical Assistance Center (TAC) Fax : ++ 1 310 252 7903

www.irf.com