

FEATURES

Output current

600 mA for the ADP2503

1000 mA for the ADP2504

Input voltage range: 2.3 V to 5.5 V

Fixed output voltage range: 2.8 V to 5.0 V

Switching frequency: 2.5 MHz

1.5 μ H inductor compatible

Typical quiescent current: 38 μ A

Automatic pulse skip mode

Synchronization pin

GENERAL DESCRIPTION

The ADP2503/ADP2504 evaluation boards are complete buck boost converter solutions that test the ADP2503/ADP2504, high efficiency, low quiescent current step-up/step-down, dc-to-dc converters. These converters provides accurate ($\pm 2\%$) regulation for load currents of up to 1 A. The ADP2503/ ADP2504 evaluation boards are available for all output voltages. Additional voltage options are available upon request from Sales at Analog Devices, Inc.

At high load currents, the ADP2503/ADP2504 use a current-mode, fixed frequency PWM control scheme for excellent stability and transient response. To ensure the longest battery life in portable applications, the ADP2503/ADP2504 feature an optional power-saving pulse skip mode that reduces the switching frequency under light load conditions to save power.

EVALUATION BOARD DIAGRAM

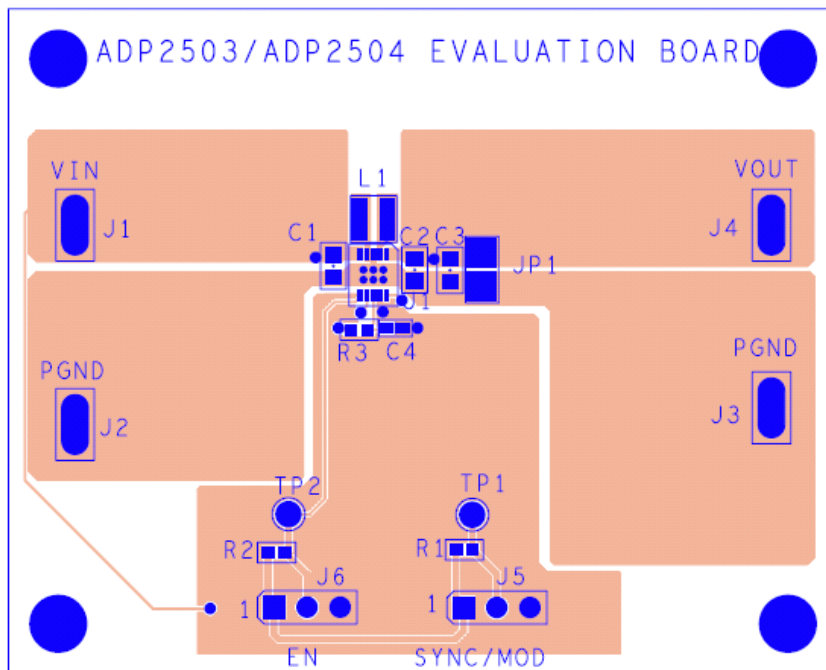

Figure 1.

Rev. A

Evaluation boards are only intended for device evaluation and not for production purposes. Evaluation boards are supplied "as is" and without warranties of any kind, express, implied, or statutory including, but not limited to, any implied warranty of merchantability or fitness for a particular purpose. No license is granted by implication or otherwise under any patents or other intellectual property by application or use of evaluation boards. Information furnished by Analog Devices is believed to be accurate and reliable. However, no responsibility is assumed by Analog Devices for its use, nor for any infringements of patents or other rights of third parties that may result from its use. Analog Devices reserves the right to change devices or specifications at any time without notice. Trademarks and registered trademarks are the property of their respective owners. Evaluation boards are not authorized to be used in life support devices or systems.

TABLE OF CONTENTS

Features	1	Measuring Evaluation Board Performance	3
General Description	1	Typical Performance Characteristics	5
Evaluation Board Diagram.....	1	Evaluation Board Schematic and Artwork.....	6
Revision History	2	Ordering Information.....	8
Using the Evaluation Board.....	3	Bill of Materials.....	8
Setting Up the Evaluation Board.....	3	Ordering Guide	8
Powering Up the Evaluation Board.....	3		

REVISION HISTORY

12/08—Rev. 0 to Rev. A

Added EVAL-ADP2503 Universal

6/08—Revision 0: Initial Version

USING THE EVALUATION BOARD

The ADP2503/ADP2504 evaluation boards are supplied fully assembled and tested. Before applying power to the evaluation board, follow the procedures in this section and refer to Figure 8.

SETTING UP THE EVALUATION BOARD

Jumper J6

Jumper J6 enables the part. Connect a jumper between Position 1 and Position 2 to enable the ADP2503/ADP2504. Connect a jumper between Position 2 to Position 3 to disable the ADP2503/ADP2504 and bring the current to $<1 \mu\text{A}$.

Jumper J5

The ADP2503/ADP2504 can be configured to operate in low noise pulse width mode (PWM) or in power save mode (PSM), depending on the SYNC pin polarity. If the SYNC pin is pulled high (Position 1 and Position 2 connected together), the converter operates in forced PWM mode. If the SYNC pin is pulled low, pulse skip mode is turned on when the load current drops below approximately 75 mA.

Input Power Source

If the input power source includes a current meter, use that meter to monitor the input current. Connect the positive terminal of the power source to the VIN terminal on the evaluation board, and connect the negative terminal of the power source to the GND terminal of the evaluation board.

If the power source does not include a current meter, connect a current meter in series with the input source voltage. Then, connect the positive lead (+) of the power source to the ammeter positive (+) connection, the negative lead (-) of the power source to the GND terminal on the evaluation board, and the negative lead (-) of the ammeter to the VIN terminal on the board.

Output Load

Connect an electronic load or resistor to set the load current. If the load includes an ammeter, or if the current is not measured, connect the load directly to the evaluation board, with the positive (+) load connection to the VOUT terminal and negative (-) load connection to the GND terminal.

If an ammeter is used, connect it in series with the load. Connect the positive (+) ammeter terminal to the evaluation board VOUT terminal, the negative (-) ammeter terminal to the positive (+) load terminal, and the negative (-) load terminal to the evaluation board GND terminal.

Input and Output Voltmeters

Measure the input and output voltages with voltmeters. Make sure that the voltmeters are connected to the appropriate evaluation board terminals and not to the loads or power sources. If the voltmeters are not connected directly to the evaluation board, the measured voltages are incorrect due to the voltage drop across the leads and/or connections between the evaluation board, the power source, and/or the load.

Connect the input voltage measuring voltmeter positive (+) terminal to the evaluation board VIN terminal, and the negative (-) terminal to the evaluation board GND terminal. Connect the output voltage measuring voltmeter positive (+) terminal to the evaluation board VOUT terminal and the negative (-) terminal to the evaluation board GND terminal.

POWERING UP THE EVALUATION BOARD

Once the power source and load are connected to the ADP2503/ADP2504 evaluation board, the board can be powered for operation. Ensure that the power source voltage is $>2.5 \text{ V}$ and $<5.5 \text{ V}$. If using an ammeter, increase the range value to 1 A or 3 A for the initial startup.

Bring the EN pin high using J6, and monitor the output voltage. If the load is not already enabled, enable the load and verify that it is drawing the proper current, and that the output voltage maintains voltage regulation.

MEASURING EVALUATION BOARD PERFORMANCE

Measuring Output Voltage Ripple

To observe the output voltage ripple, place an oscilloscope probe across the output capacitors (C2 and C3) with the probe ground lead at the negative (-) capacitor terminal and the probe tip at the positive (+) capacitor terminal. Set the oscilloscope to ac, 20 mV/division, and 2 μs /division time base.

Measuring the Switching Waveform

To observe the switching waveform with an oscilloscope, place the oscilloscope probe tip at the end of the inductor connected to the SW1 pin/SW2 pin with the probe ground at GND. Set the oscilloscope to dc, 2 V/division, and 2 μs /division time base.

Measuring Load Regulation

The load regulation must be tested by increasing the load at the output and looking at the change in output voltage. To minimize voltage drop, use short low resistance wires, especially for heavy loads.

Measuring Line Regulation

Vary the input voltage and examine the change in the output voltage.

EVAL-ADP2503/ADP2504

Measuring Efficiency

Measure the efficiency, η , by comparing the input power with the output power.

$$\eta = \frac{V_{OUT} \times I_{OUT}}{V_{IN} \times I_{IN}}$$

Measure the input and output voltages as close as possible to the input and output capacitors to reduce the effect of IR drops.

Measuring Inductor Current

Measure the inductor current by removing one end of the inductor from its pad and connecting a current loop in series. Then, use a current probe to measure the current flowing through the current loop.

TYPICAL PERFORMANCE CHARACTERISTICS

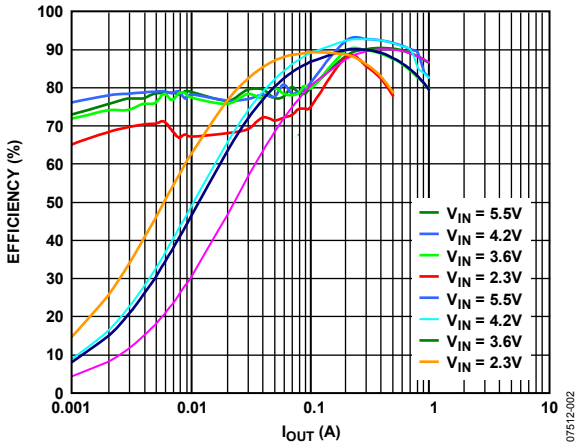

Figure 2. Efficiency vs. Load, $V_{OUT} = 3.3\text{ V}$, PWM and PSM

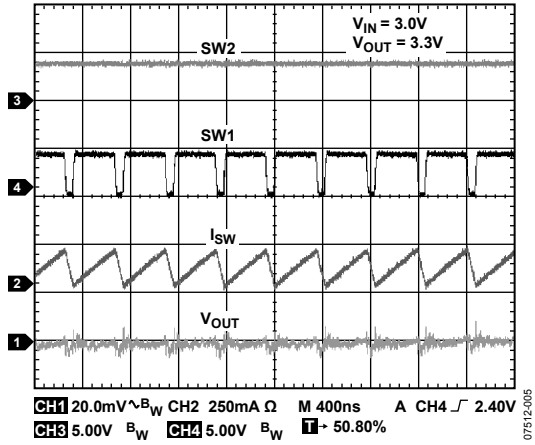

Figure 5. Boost Operation, $V_{IN} = 3.0\text{ V}$, $V_{OUT} = 3.3\text{ V}$, PWM

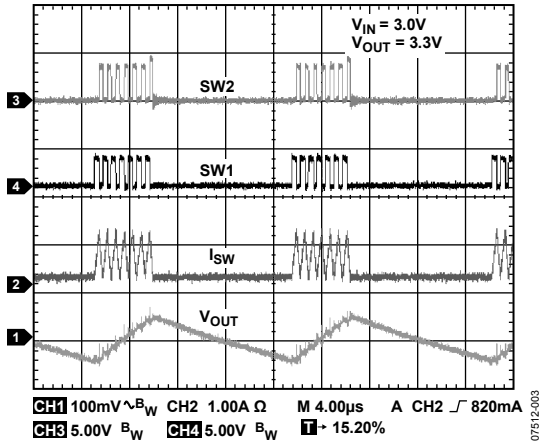

Figure 3. Buck Boost, $V_{IN} = 3.0\text{ V}$, $V_{OUT} = 3.3\text{ V}$, PSM

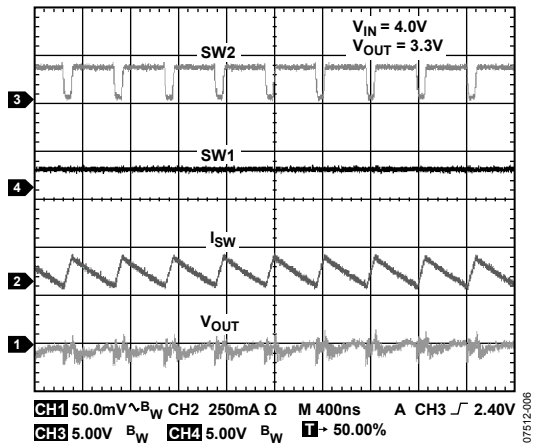

Figure 6. Buck Operation, $V_{IN} = 4.0\text{ V}$, $V_{OUT} = 3.3\text{ V}$, PWM

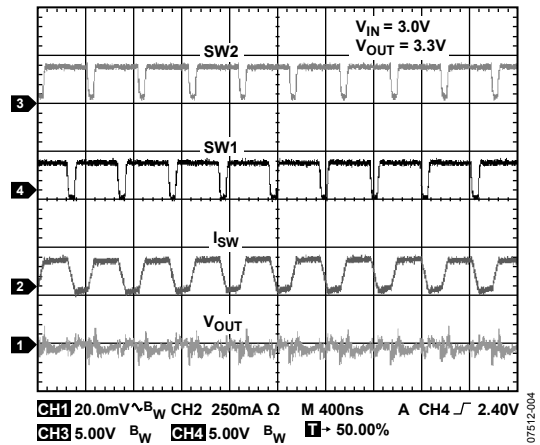

Figure 4. Buck Boost, $V_{IN} = 3.0\text{ V}$, $V_{OUT} = 3.3\text{ V}$, PWM

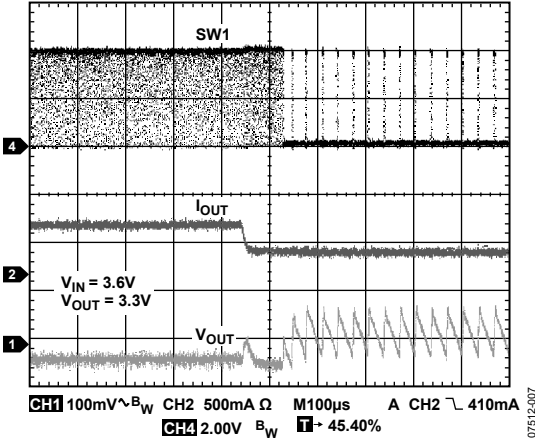

Figure 7. Mode Change by Load Transients, Load Fall ($V_{OUT} = 3.3\text{ V}$)

EVAL-ADP2503/ADP2504

EVALUATION BOARD SCHEMATIC AND ARTWORK

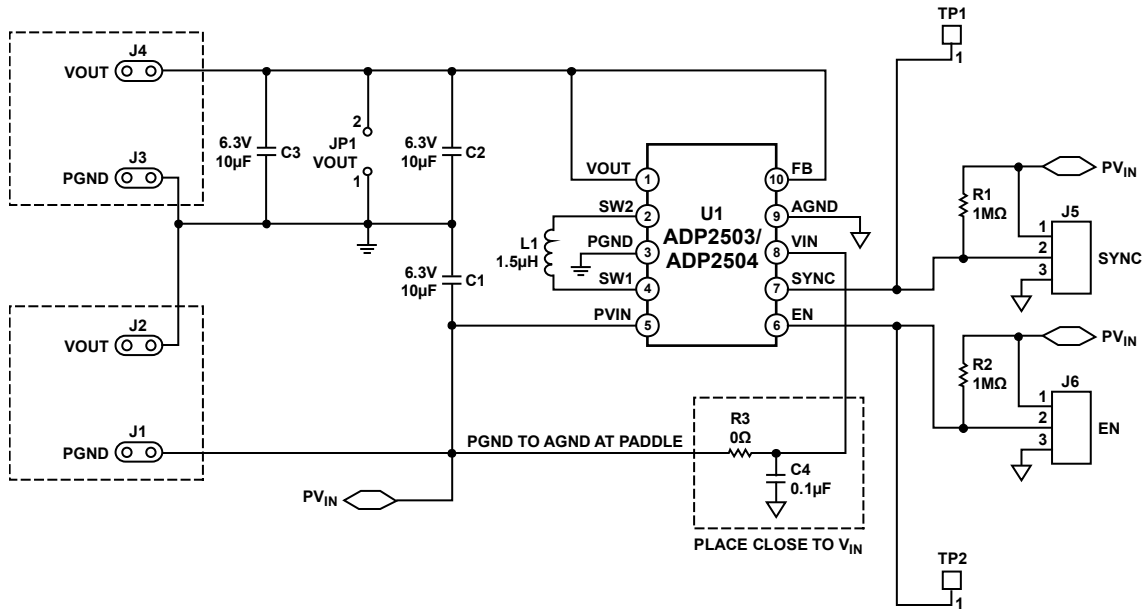

Figure 8. ADP2503/ADP2504 Evaluation Board Schematic

07512-008

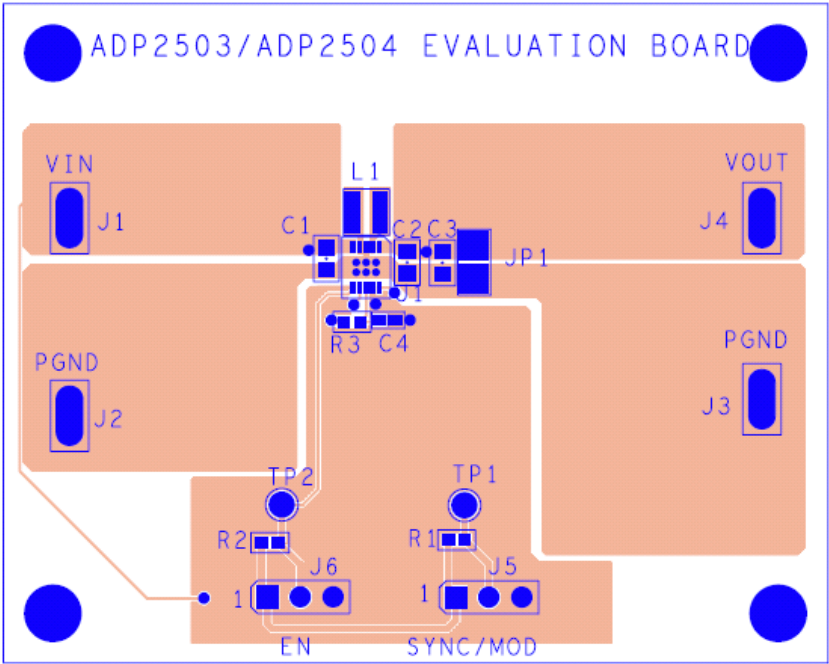

Figure 9. Top Layer, Recommended Layout

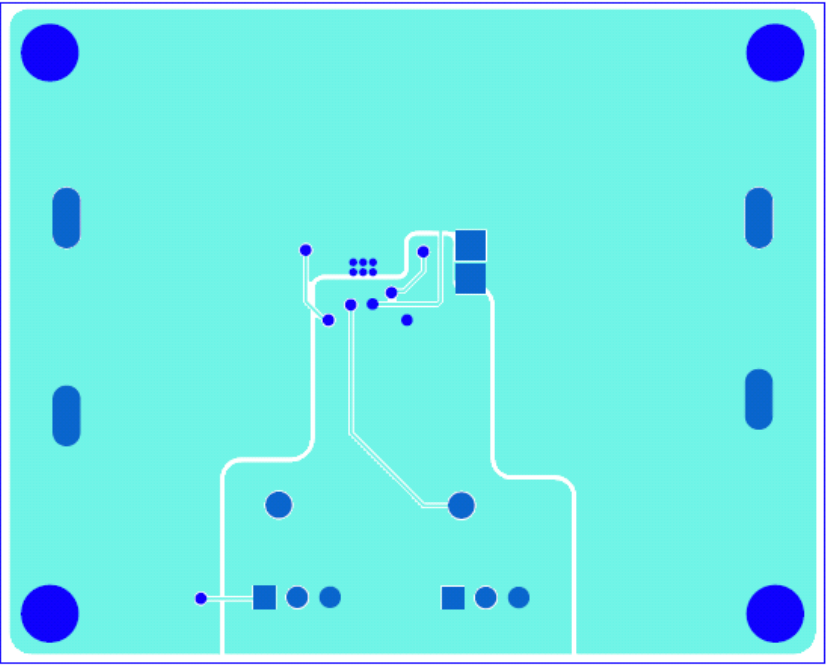

Figure 10. Bottom Layer, Recommended Layout

EVAL-ADP2503/ADP2504

ORDERING INFORMATION

BILL OF MATERIALS

Table 5.

Qty	Reference Designator	Description	Manufacturer	Part Number
3	C1, C2, C3	Capacitor, 10 μ F, 6.3 V, 0603, X5R	Murata Manufacturing Co., Ltd	GRM188R60J106M
1	C4	Capacitor, 0.1 μ F, 6.3 V, 0603, X5R	Phycomp	223878615649
1	L1	Inductor, 1.5 μ H	Murata Manufacturing Co., Ltd	LQM2HPN1R5MG0L
2	R1, R2	Resistor, 1 M Ω	Vishay Intertechnology, Inc.	CRCW04021004F
1	R3	Resistor, 0 Ω	Vishay Intertechnology, Inc.	CRCW04020R00F
1	U1	Buck Boost Regulator	Analog Devices	ADP2503 or ADP2504

ORDERING GUIDE

Model	Description
ADP2503-2.8-EVALZ ¹	Evaluation Board for 2.8 V
ADP2503-3.3-EVALZ ¹	Evaluation Board for 3.3 V
ADP2503-3.5-EVALZ ¹	Evaluation Board for 3.5 V
ADP2503-4.2-EVALZ ¹	Evaluation Board for 4.2 V
ADP2503-4.5-EVALZ ¹	Evaluation Board for 4.5 V
ADP2503-5.0-EVALZ ¹	Evaluation Board for 5.0 V
ADP2504-2.8-EVALZ ¹	Evaluation Board for 2.8 V
ADP2504-3.3-EVALZ ¹	Evaluation Board for 3.3 V
ADP2504-3.5-EVALZ ¹	Evaluation Board for 3.5 V
ADP2504-4.2-EVALZ ¹	Evaluation Board for 4.2 V
ADP2504-4.5-EVALZ ¹	Evaluation Board for 4.5 V
ADP2504-5.0-EVALZ ¹	Evaluation Board for 5.0 V

¹Z = RoHS Compliant Part.

ESD CAUTION



ESD (electrostatic discharge) sensitive device.

Charged devices and circuit boards can discharge without detection. Although this product features patented or proprietary protection circuitry, damage may occur on devices subjected to high energy ESD. Therefore, proper ESD precautions should be taken to avoid performance degradation or loss of functionality.