

# LM22670 Evaluation Board Inverting Topology and Application Notes

National Semiconductor  
Application Note 1888  
Frederik Dostal  
July 9, 2009



## Introduction

The LM22670 inverting evaluation board is designed to demonstrate the capabilities of the LM22670 switching regulator in a polarity-inverting topology. The LM22670 inverting evaluation board schematic shown in *Figure 1* is configured to provide an output of minus 5V (-5V) up to 1.5A load current with an input voltage range of 6V to 35V. The typical operating frequency is 500 kHz.

The evaluation board is designed to operate at ambient temperatures up to 50°C. Typical evaluation board performance and characteristics curves are shown in *Figure 5* through *Figure 7*. *Figure 8* shows the PCB layout.

To aid in the design and evaluation of DC/DC polarity-inverting converter solutions based on the LM22670 switching regulator, the evaluation board can be re-configured for different output voltages.

The evaluation board is designed to highlight applications with a small solution size. This implies that there will be a trade-off between size and the area of heat dissipation available. If this evaluation board is operated continuously at a full 1.5A load, it will get hot. For more negative output voltages than the pre-adjusted -5V, the total output power as well as the total power conversion losses will increase.

Test points are provided to enable easy connection and monitoring of critical signals.

For more information about device function and electrical characteristics, refer to the LM22670 datasheet. The evaluation board can be reconfigured for a different load current and output voltage. For design limitations, see the IC Device Ratings section.

The performance of the evaluation board is as follows:

Input Range: 6V to 35V, 12V nominal

Output Voltage: -5V

Output Current Range: 0A to 1.5A

Frequency of Operation: 500 kHz

Board Size: 1.5 X 1.65 inches

Package: PSOP-8

## Evaluation Board Startup

Before applying power to the LM22670 polarity-inverting evaluation board, all external connections should be verified. The external power supply input must be turned off and connected with proper polarity to the VIN and GND posts. A load resistor or electronic load should be connected between the VOUT and GND posts as desired. Both the VIN and VOUT connections should use the closest GND posts respective to VIN or VOUT. The output voltage can be monitored with a multi-meter or oscilloscope at the VOUT post. Once all connections to the evaluation board have been verified, input power can be applied. A load resistor or electronic load does not need to be connected during startup. If the EN test point is left floating, the output voltage will ramp up when an input voltage is applied. Make sure that the external power supply (input voltage power source) is capable of providing enough current so that the adjusted output voltage can be obtained. Keep in mind that the startup current will be greater than the steady state current.

## Principle of Operation

The polarity-inverting converter, shown in *Figure 1*, uses the basic principle of energy storage in the inductor, L1, during on-time and transfers the energy through the diode, D1, to the output during off-time. When the switch turns on, the diode is reverse biased and the inductor current will ramp up linearly. When the switch turns off, the inductor will reverse its polarity in order to maintain the peak switch current. At that time, the diode, D1, will be forward biased and the energy stored in the inductor will be transferred to the load as well as the output capacitor, C4.

Since the switch node is negative with respect to ground, the output voltage across the output capacitors (C4 and C5) will become negative.

This type of polarity-inverting converter can step-up and step-down the magnitude of the input voltage, which makes this circuit a buck-boost converter. However, the output voltage is always negative in reference to ground.

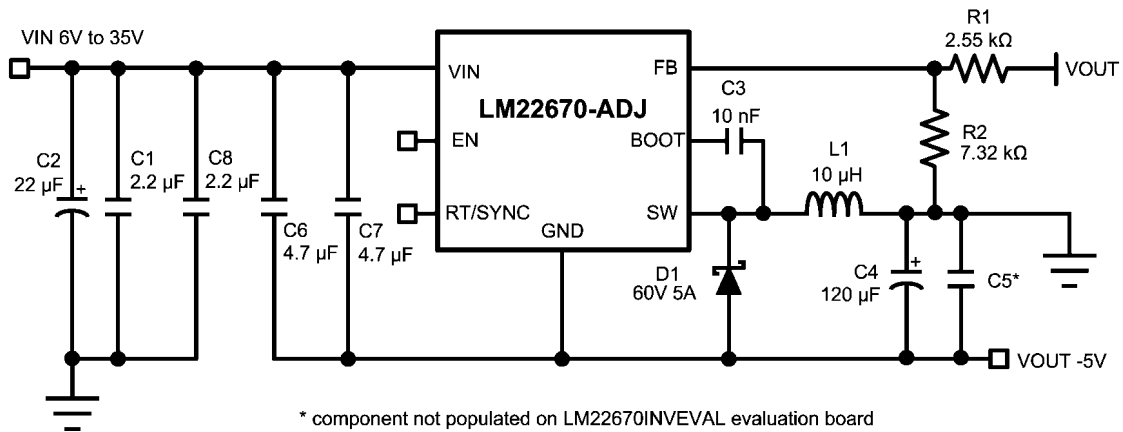

30075201

FIGURE 1. Evaluation Board Schematic Inverting Topology

## Design Considerations

Figure 1 shows the typical configuration of a polarity-inverting converter using the LM22670 switching regulator. This inverting topology design can be implemented with any member of the LM2267X SIMPLE SWITCHER® family. Note that the ground pin (GND) of the LM22670 is connected to the negative output, VOUT, and the feedback resistor divider is referred to GND. No extra level shift and inversion of the feedback signal is required to regulate the negative output voltage. This buck-boost application is also possible with the fixed voltage version of the LM22670 by connecting the feedback pin directly to ground of the system. A polarity-inverting topology is particularly difficult to stabilize as it has a right-half plane zero in its control to output transfer function. Two compensation capacitor, C6 and C7, are connected from the input to the negative output in order to provide more phase margin and stabilize the loop. For output currents less than 100 mA, the converter can be operated in discontinuous current conduction mode (DCM) and capacitors C6 and C7 are not required. When capacitors C6 and C7 are used and voltage is first applied to the application, the initial capacitor charge current will cause a positive voltage spike on the output. This positive voltage spike is typically too small to cause any damage on the output capacitor. The initial input capacitor charge current will cause a voltage drop across the capacitor ESR. Since the ESR from capacitors C6 and C7 and output capacitors C4 and C5 form a voltage divider, the magnitude of the initial voltage spike will be dependent upon the ESR values of these capacitors. Since the overall output capacitor ESR value is typically larger than the compensation capacitor ESR value, the initial voltage spike will be typically below 500 mV. The faster the input voltage slew rate applied to the circuit, the larger the positive voltage spike. If the inductor DC resistance is 2Ω or greater and the initial start-up current is high, the positive voltage spike may be higher than 500 mV. An additional clamping diode, D2, can be used in parallel to the output capacitor C4 to clamp this positive voltage spike to typically 300 mV if a small Schottky diode is used. Shown in Figure 2. In most cases this clamp is not required.

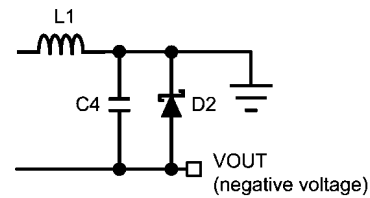

30075202

FIGURE 2. Optional Protection Diode D2

## Component Selection

This section details the component calculation and selection for polarity-inverting converter applications. The calculations are for continuous current conduction mode (CCM) operation.

## Inductor Selection

Duty-cycle is calculated as:

$$D = \frac{IV_{OUT} + V_D}{V_{IN} + IV_{OUT} + V_D - V_Q}$$

where  $V_D$  is the D1 diode voltage drop and  $V_Q$  is the voltage drop across the LM22670 internal power N-FET. The  $R_{DS(ON)}$  of the FET is specified in the LM22670 datasheet to calculate  $V_Q$  according to the FET current.

$$V_Q = I_{PEAK} \times R_{DS(ON)}$$

where  $I_{PEAK}$  is the peak switch current of the application. The average inductor current,  $I_L$ , in reference to the application load current,  $I_{OUT}$ , is defined as:

$$I_L = \frac{I_{OUT}}{1 - D}$$

There are multiple ways to calculate the required inductance for a switching application. The recommended calculation is to choose the inductor ripple current,  $\Delta I_L$ , of approximately 30% of the average inductor current  $I_L$ . This will make the regulator operate in continuous current conduction mode (CCM) and the application circuit will have a small load transient response with an acceptable output voltage ripple. Therefore the peak-to-peak inductor ripple current,  $\Delta I_L$ , is selected as:

$$\Delta I_L \cong 0.3 \times I_L$$

This makes the required inductance:

$$L = \frac{V_{IN} \times D}{F \times \Delta I_L}$$

where  $F$  is the switching frequency of the application. The LM22670 will switch at 500 kHz typical if the RT/SYNC pin is floating. The inductor should have a RMS current rating equal to or greater than the maximum current limit,  $I_{CL}$ , in order to avoid inductor saturation. The values for maximum current limit,  $I_{CL}$ , can be found in the electrical characteristics section of the LM22670 datasheet.

## IC Device Ratings

The DC/DC polarity-inverting converter needs to be rated for the peak switch current,  $I_{PEAK}$ , and maximum input voltage,  $V_{INMAX}$ , as described below. Peak switch current is:

$$I_{PEAK} = I_L + \frac{\Delta I_L}{2}$$

Since the ground pin, GND, of the LM22670 is connected to the output voltage, the maximum input voltage rating has to be able to withstand the application input voltage,  $V_{IN}$ , plus the absolute value of output voltage,  $V_{OUT}$ . Maximum input voltage rating of the IC is as follows:

$$V_{INMAX} = V_{IN} + IV_{OUT}$$

Maximum load current,  $I_{OUT(MAX)}$ , is dependent upon the duty-cycle,  $D$ , and the inductor value,  $L$ . This is important because the LM22670 3A step-down switching regulator cannot typi-

cally deliver a 3A load current in a polarity-inverting topology as shown in *Figure 3*.

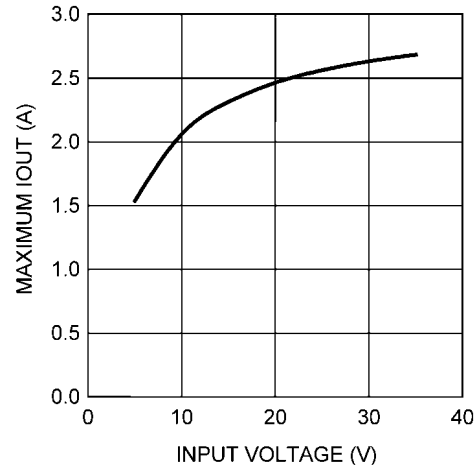

30075218

**FIGURE 3. LM22670 Input Voltage vs Maximum Load Current ( $V_{OUT} = -5V$ ,  $L = 10 \mu H$ )**

The formula for maximum load current in a given circuit is:

$$I_{OUT(MAX)} = \left( I_{CLMIN} - \frac{V_{IN} \times D}{2 \times F \times L} \right) \times (1 - D)$$

where  $F$  is the switching frequency and  $I_{CLMIN}$  is the minimum current limit threshold as specified in the electrical characteristics section of the LM22670 datasheet.

## Diode Ratings

Diode, D1, has to be able to meet the following parameters:

$$I_{DMAX} = I_{PEAK}$$

$$V_{DMAX} = V_{IN} + IV_{OUT}$$

where  $I_{DMAX}$  is the maximum current rating and  $V_{DMAX}$  is the maximum voltage rating of the diode, D1.

A Schottky diode with a low forward voltage rating is recommended to achieve high converter efficiency and low EMI.

## Output Capacitor Selection

The output capacitor needs to be selected primarily for a low ESR value, but the capacitance must also be able to deliver the maximum load current when the switch is on. The ESR value will determine the load impedance and output voltage ripple at the first moment diode, D1, becomes forward biased. Thus the required ESR for a desired output voltage ripple,  $\Delta V_{OUT}$ , is calculated as:

$$ESR = \frac{\Delta V_{OUT}}{I_{PEAK}}$$

The minimum output capacitor value,  $C_{OUTMIN}$ , for a desired output voltage ripple and load current is:

$$C_{OUTMIN} = \frac{I_{OUT} \times D}{F \times \Delta V_{OUT}}$$

## Input Capacitor Selection

The input capacitor needs to be selected based on its low ESR value and the high RMS current rating capable of supporting high current changes on the input of the application. Low ESR bypass capacitors located close to the input pin of the switching regulator are recommended. A larger ESR input capacitor is useful for input filtering purposes to reduce inductive kicks on the supply line and to keep the input filter corner frequencies away from the bandwidth of the switching regulator.

In general, applications using the polarity-inverting (buck-boost) topology generate noise on both the input as well as the output. This noise makes the input and the output capacitors important components.

## Synchronization and Adjustable Frequency

To use the synchronization feature, it is important to apply a synchronization voltage in reference to the LM22670 ground pin, GND, which has the same potential as the negative output voltage in an inverting topology. Some level shifting of the synchronization pulse might be necessary to stay within the absolute maximum rating of the RT/SYNC pin.

The switching frequency can be adjusted higher or lower than 500 kHz by connecting a resistor from the RT/SYNC pin to the LM22670 GND pin. Refer to the LM22670 datasheet for more details about the synchronizing and adjustable frequency features.

## Precision Enable

The LM22670 can be shut down if the EN pin is pulled low. In the inverting topology, this means that the EN pin is pulled to a voltage close to the GND pin voltage which is the negative output voltage. If an external signal is applied, care must be taken so that the voltage at the EN pin is never higher than the maximum allowed voltage according to the absolute maximum rating in the LM22670 datasheet in reference to the GND pin. Since the GND pin of the LM22670 becomes the negative output voltage in an inverting application, level shifting might be necessary when using the EN pin. If the EN pin is not used in an application, it may be left floating.

## PCB Layout Guidelines

The printed circuit board (PCB) layout for the LM22670 switching regulator in polarity-inverting topology is shown in *Figure 8*. Similar PCB layouts can be used for other versions of the LM2267X SIMPLE SWITCHER® family. It is very important to place the input capacitor as close as possible to the input pin of the switching regulator. In order to achieve optimal performance, the switching regulator needs to be properly grounded. It is recommended to use a separate ground plane and a single point ground structure. Especially, at load currents above 1A, trace layout and component placement is critical, otherwise, high switching currents will cause malfunction. The parasitic trace inductance is often the main cause of high voltage spikes as well as EMI problems on the input and output lines.

*Figure 4* shows the current flow of a polarity-inverting (buck-boost) converter. The top schematic shows dotted lines which represent the current flow during an on-state. The middle schematic shows the current flow during an off-state. The bottom schematic shows the currents referred to as AC currents. These AC currents are the most critical since current is

changing in very short time periods. The dotted lines of the bottom schematic show the traces to keep as short as possible. This will yield a small area reducing the loop inductance. Comparing the AC traces of the polarity-inverting topology with a buck or boost topology shows that the polarity-inverting topology has more critical AC traces. It is usually not possible to keep all critical AC traces as tight as possible at the same time and some tradeoffs need to be made.

In sensitive applications, input and output voltage spikes may not be acceptable even when using low ESR input and output filter capacitors. In such cases additional input and output L/C filters should be considered.

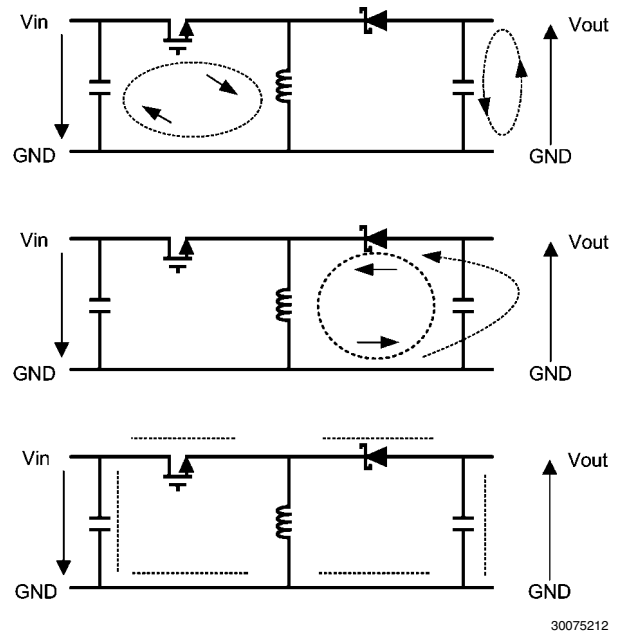

FIGURE 4. Current Flow in a Polarity-Inverting (Buck-Boost) Application

## Stability Considerations

Pulse width modulated switch mode DC/DC converters consist of a frequency response control loop. It is necessary for the design to be stable over all operating conditions.

The value of the inductor, output capacitor, including ESR, as well as compensation capacitors, C6 and C7, will influence the switching regulator loop stability. The polarity-inverting converter will need to be tested for stability.

The first stability test is to observe the switch voltage waveform on the SW pin of the LM22670. This waveform should be stable and free of jitter under all input voltage and load current conditions, which is an indication of a stable design. The next stability measurement is a pulsating load test or load transient response. During this test, the load current is pulsed (rectangular waveform, fast rise time) between minimum and maximum load while the output voltage waveform is monitored with an oscilloscope. Under these conditions, the output voltage should respond without excessive oscillation to load current changes. This pulsating load test or load transient response also needs to be verified under all input voltage conditions. If the switching regulator exhibits stability problems during these tests, the output capacitor and/or compensation capacitors, C6 and C7, should be changed accordingly. For the LM22670 polarity-inverting (buck-boost) application, the stability will typically improve with an increase

in the capacitance value of C6 and C7. *Figure 7* shows the stability of the LM22670INVEVAL evaluation board taken with a 1.5A load current and a 12V input voltage. At input voltages below 6V, the phase margin decreases significantly. To increase the phase margin for applications using low input voltages, select a higher capacitance value for C6 and C7. It

can be helpful to plot the loop transfer function by taking a Bode plot using a network analyzer.

Application Note AN-1889 explains in detail how to take a Bode plot measurement using only an oscilloscope and a function generator.

**TABLE 1. LM22670INVEVAL Bill of Materials for VOUT = -5V, Designed for 1.5A Output Current**

Ref #	Value	Supplier	Part Number
C1, C8	2.2 $\mu$ F 50V ceramic	TDK	C3225X7R1H225K
C2	22 $\mu$ F 63V electrolytic	Panasonic	EEEFK1J220XP
C3	10 nF 50V ceramic	TDK	C1608X7R1H103K
C4	120 $\mu$ F 6.3V 24 m $\Omega$ ESR	Nippon Chemi-Con	APXE6R3ARA121ME61G
C5	Not Populated	-	
C6, C7	4.7 $\mu$ F 50V ceramic	TDK	C4532X7R1H475M
D1	60V, 5A	Central Semiconductor	CMSH5-60
L1	10 $\mu$ H 4.09A	Würth	WE-PD L 74477110
		Coilcraft	MSS1260-103MLD
R1	2.55 k $\Omega$	Vishay/Dale	CRCW06032K55FKEA
R2	7.32 k $\Omega$	Vishay/Dale	CRCW06037K32FKEA
R3	Not Populated	-	
U1		National Semiconductor	LM22670MR-ADJ

## Performance Characteristics

Unless otherwise specified,  $V_{IN} = 12V$ ,  $T_A = 25^\circ C$ ,  $V_{OUT} = -5V$ .

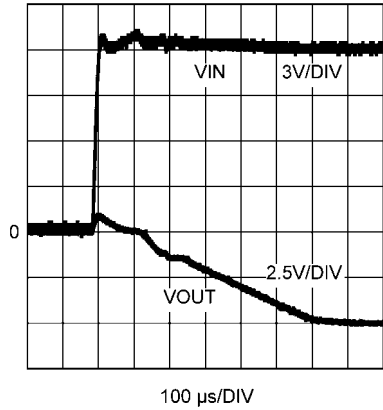

30075219

**FIGURE 5. Start-Up Waveforms  
(Load Resistor = 4Ω)**

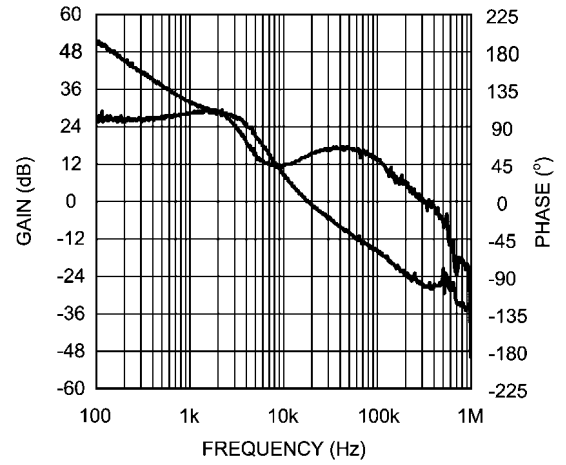

30075220

**FIGURE 7. Overall Loop Gain and Phase  
( $I_{OUT} = 1.5A$ )**

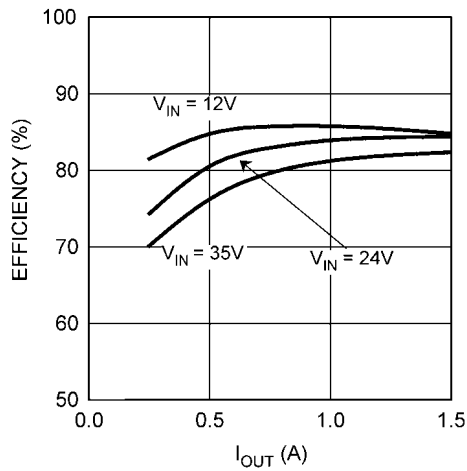

30075217

**FIGURE 6. Efficiency vs  $I_{OUT}$**

# PCB Layout Diagram

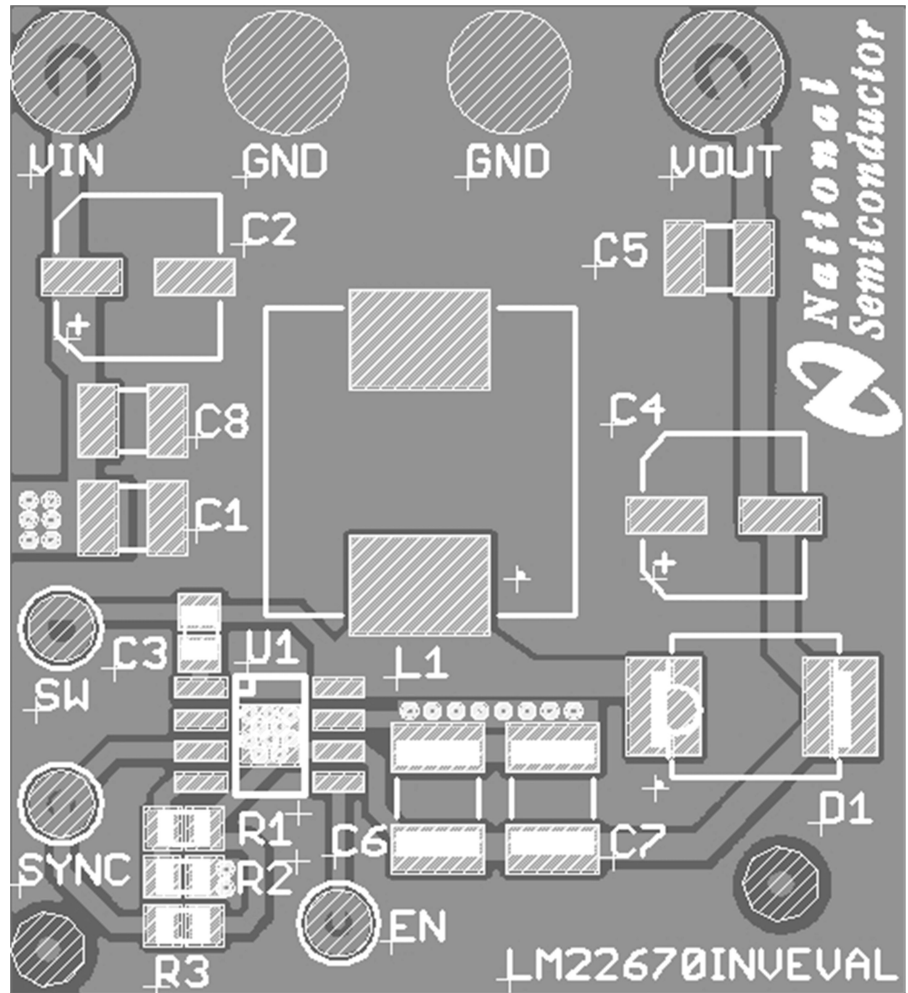

30075213





30075214

FIGURE 8. LM22670INVEVAL PCB Layout





## Notes

For more National Semiconductor product information and proven design tools, visit the following Web sites at:

Products		Design Support	
Amplifiers	<a href="http://www.national.com/amplifiers">www.national.com/amplifiers</a>	WEBENCH® Tools	<a href="http://www.national.com/webench">www.national.com/webench</a>
Audio	<a href="http://www.national.com/audio">www.national.com/audio</a>	App Notes	<a href="http://www.national.com/appnotes">www.national.com/appnotes</a>
Clock and Timing	<a href="http://www.national.com/timing">www.national.com/timing</a>	Reference Designs	<a href="http://www.national.com/refdesigns">www.national.com/refdesigns</a>
Data Converters	<a href="http://www.national.com/adc">www.national.com/adc</a>	Samples	<a href="http://www.national.com/samples">www.national.com/samples</a>
Interface	<a href="http://www.national.com/interface">www.national.com/interface</a>	Eval Boards	<a href="http://www.national.com/evalboards">www.national.com/evalboards</a>
LVDS	<a href="http://www.national.com/lvds">www.national.com/lvds</a>	Packaging	<a href="http://www.national.com/packaging">www.national.com/packaging</a>
Power Management	<a href="http://www.national.com/power">www.national.com/power</a>	Green Compliance	<a href="http://www.national.com/quality/green">www.national.com/quality/green</a>
Switching Regulators	<a href="http://www.national.com/switchers">www.national.com/switchers</a>	Distributors	<a href="http://www.national.com/contacts">www.national.com/contacts</a>
LDOs	<a href="http://www.national.com/lido">www.national.com/lido</a>	Quality and Reliability	<a href="http://www.national.com/quality">www.national.com/quality</a>
LED Lighting	<a href="http://www.national.com/led">www.national.com/led</a>	Feedback/Support	<a href="http://www.national.com/feedback">www.national.com/feedback</a>
Voltage Reference	<a href="http://www.national.com/vref">www.national.com/vref</a>	Design Made Easy	<a href="http://www.national.com/easy">www.national.com/easy</a>
PowerWise® Solutions	<a href="http://www.national.com/powerwise">www.national.com/powerwise</a>	Solutions	<a href="http://www.national.com/solutions">www.national.com/solutions</a>
Serial Digital Interface (SDI)	<a href="http://www.national.com/sdi">www.national.com/sdi</a>	Mil/Aero	<a href="http://www.national.com/milaero">www.national.com/milaero</a>
Temperature Sensors	<a href="http://www.national.com/tempensors">www.national.com/tempensors</a>	SolarMagic™	<a href="http://www.national.com/solarmagic">www.national.com/solarmagic</a>
Wireless (PLL/VCO)	<a href="http://www.national.com/wireless">www.national.com/wireless</a>	PowerWise® Design University	<a href="http://www.national.com/training">www.national.com/training</a>

THE CONTENTS OF THIS DOCUMENT ARE PROVIDED IN CONNECTION WITH NATIONAL SEMICONDUCTOR CORPORATION ("NATIONAL") PRODUCTS. NATIONAL MAKES NO REPRESENTATIONS OR WARRANTIES WITH RESPECT TO THE ACCURACY OR COMPLETENESS OF THE CONTENTS OF THIS PUBLICATION AND RESERVES THE RIGHT TO MAKE CHANGES TO SPECIFICATIONS AND PRODUCT DESCRIPTIONS AT ANY TIME WITHOUT NOTICE. NO LICENSE, WHETHER EXPRESS, IMPLIED, ARISING BY ESTOPPEL OR OTHERWISE, TO ANY INTELLECTUAL PROPERTY RIGHTS IS GRANTED BY THIS DOCUMENT.

TESTING AND OTHER QUALITY CONTROLS ARE USED TO THE EXTENT NATIONAL DEEMS NECESSARY TO SUPPORT NATIONAL'S PRODUCT WARRANTY. EXCEPT WHERE MANDATED BY GOVERNMENT REQUIREMENTS, TESTING OF ALL PARAMETERS OF EACH PRODUCT IS NOT NECESSARILY PERFORMED. NATIONAL ASSUMES NO LIABILITY FOR APPLICATIONS ASSISTANCE OR BUYER PRODUCT DESIGN. BUYERS ARE RESPONSIBLE FOR THEIR PRODUCTS AND APPLICATIONS USING NATIONAL COMPONENTS. PRIOR TO USING OR DISTRIBUTING ANY PRODUCTS THAT INCLUDE NATIONAL COMPONENTS, BUYERS SHOULD PROVIDE ADEQUATE DESIGN, TESTING AND OPERATING SAFEGUARDS.

EXCEPT AS PROVIDED IN NATIONAL'S TERMS AND CONDITIONS OF SALE FOR SUCH PRODUCTS, NATIONAL ASSUMES NO LIABILITY WHATSOEVER, AND NATIONAL DISCLAIMS ANY EXPRESS OR IMPLIED WARRANTY RELATING TO THE SALE AND/OR USE OF NATIONAL PRODUCTS INCLUDING LIABILITY OR WARRANTIES RELATING TO FITNESS FOR A PARTICULAR PURPOSE, MERCHANTABILITY, OR INFRINGEMENT OF ANY PATENT, COPYRIGHT OR OTHER INTELLECTUAL PROPERTY RIGHT.

#### LIFE SUPPORT POLICY

**NATIONAL'S PRODUCTS ARE NOT AUTHORIZED FOR USE AS CRITICAL COMPONENTS IN LIFE SUPPORT DEVICES OR SYSTEMS WITHOUT THE EXPRESS PRIOR WRITTEN APPROVAL OF THE CHIEF EXECUTIVE OFFICER AND GENERAL COUNSEL OF NATIONAL SEMICONDUCTOR CORPORATION.** As used herein:

Life support devices or systems are devices which (a) are intended for surgical implant into the body, or (b) support or sustain life and whose failure to perform when properly used in accordance with instructions for use provided in the labeling can be reasonably expected to result in a significant injury to the user. A critical component is any component in a life support device or system whose failure to perform can be reasonably expected to cause the failure of the life support device or system or to affect its safety or effectiveness.

National Semiconductor and the National Semiconductor logo are registered trademarks of National Semiconductor Corporation. All other brand or product names may be trademarks or registered trademarks of their respective holders.

Copyright© 2009 National Semiconductor Corporation

For the most current product information visit us at [www.national.com](http://www.national.com)



**National Semiconductor Americas Technical Support Center**  
Email: [support@nsc.com](mailto:support@nsc.com)  
Tel: 1-800-272-9959

**National Semiconductor Europe Technical Support Center**  
Email: [europe.support@nsc.com](mailto:europe.support@nsc.com)

**National Semiconductor Asia Pacific Technical Support Center**  
Email: [ap.support@nsc.com](mailto:ap.support@nsc.com)

**National Semiconductor Japan Technical Support Center**  
Email: [jpn.feedback@nsc.com](mailto:jpn.feedback@nsc.com)