

LMZ1050x Evaluation Board

National Semiconductor
Application Note 2022
Ricardo Capetillo
August 12, 2010



Introduction

The LMZ1050x SIMPLE SWITCHER® power module is a complete, easy-to-use DC-DC solution capable of driving up to 3A, 4A, or 5A load with exceptional power conversion efficiency, output voltage accuracy, line and load regulation. The LMZ1050x is available in an innovative package that enhances thermal performance and allows for hand or machine soldering.

The LMZ1050x can accept an input voltage rail between 2.95V and 5.5V and deliver an adjustable and highly accurate output voltage as low as 0.8V. One megahertz fixed frequency PWM switching provides a predictable EMI characteristic. Two external compensation components can be adjusted to set the fastest response time, while allowing the option to use ceramic and/or electrolytic output capacitors. Externally programmable soft-start capacitor facilitates controlled startup. The LMZ1050x is a reliable and robust solution with the following features: lossless cycle-by-cycle peak current limit to protect for over current or short-circuit fault, thermal shut-down, input under-voltage lock-out, and pre-biased startup.

Board Specifications

- $V_{IN} = 2.95V$ to 5.5V
- $V_{OUT} = 2.5V$ (default output voltage setting, refer to [Table 2](#) for other output settings)
- $\pm 2.5\%$ feedback voltage accuracy at 2.5V output (Including line and load regulation from $T_J = -40^\circ C$ to $125^\circ C$)
- $\pm 1.63\%$ feedback voltage accuracy over temperature
- $I_{OUT} = 0A$ to 3A, 4A, and 5A
- $\theta_{JA} = 20^\circ C / W$, $\theta_{JC} = 1.9^\circ C / W$
- Designed on four layers, the top and bottom layers are 1oz. copper and the two inner layers are 1/2 oz. copper weight
- Measures 2.25 in. x 2.25 in. (5.8 cm x 5.8 cm) and is 62mil (.062") thick on a FR4 laminate

Evaluation Board Design Concept

The evaluation board is designed to demonstrate low conducted noise on the input and output lines, as seen in [Figure 11](#) and [Figure 14](#). Four input capacitors ($C_{in1} - C_{in4}$) and three output capacitors ($C_{o1} - C_{o3}$) are populated for this purpose. All the input and output filter capacitors are not necessary to comply with radiation standards. For a circuit example that passes radiated emissions standards (EN55022, class B) please refer to [Figure 19](#). Additionally, C_{in5} is present to reduce the resonance of the input line produced by the inductance and resistance in the cables connecting the bench power supply to the evaluation board and the input capacitors.

Additional Component Footprints

When the tracking feature of the LMZ1050x is used, remove the soft-start capacitor C_{SS} and use a resistor divider on designators R_{trkb} and R_{trkt} . The ground and V_{trk} post have been provided for easy connection.

The LMZ1050x eval board incorporates a precision enable circuit which is pulled high by a 100 k Ω pull up resistor to V_{IN} . This allows the user to pull low on the enable pin to ground. The top enable resistor is R_{ent} and the bottom enable resistor is R_{enb} . Refer to the Design Guideline and Operating Description section of the LMZ1050x data sheet for detailed design implementation.

Select FPGAs specify input inrush currents for particular power-up sequences and others require sequencing rails to avoid start-up or latch-up problems. To prevent early turn-on of the LMZ1050x in systems with multiple power rails, precision enable and tracking are useful as the main input voltage rail rises at power-up.

Component Circuit Schematic

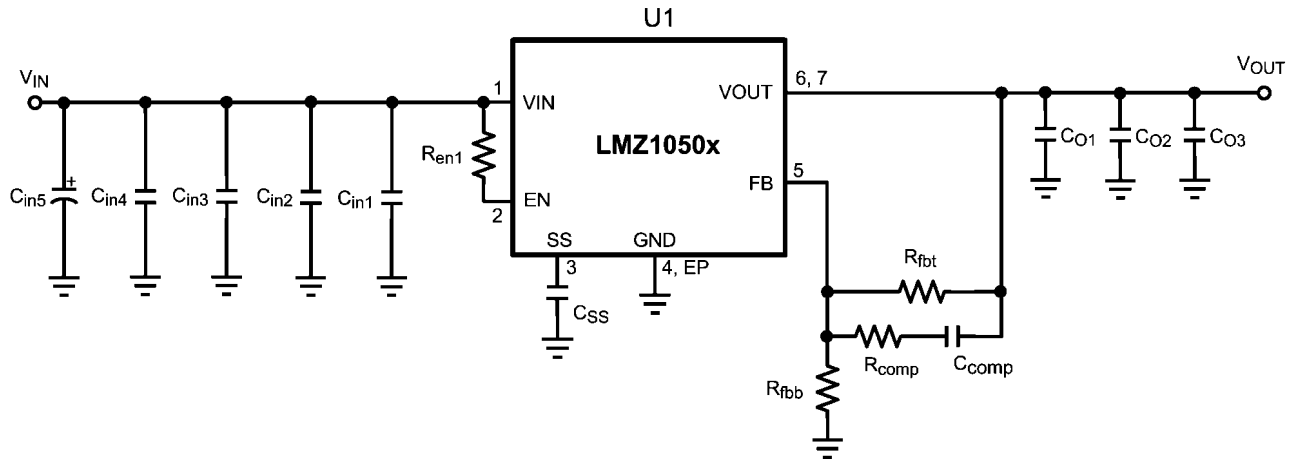

30111317

FIGURE 1. Component Schematic for Evaluation Board

TABLE 1. Bill of Materials for Evaluation Board, $V_{IN} = 3.3V$ to $5V$, $V_{OUT} = 2.5V$

Designator	Description	Case Size	Manufacturer	Manufacturer P/N	Quantity
U1	SIMPLE SWITCHER®	TO-PMOD-7	National Semiconductor	LMZ1050xTZ-ADJ	1
C_{in1}	1 μF , X7R, 16V	0805	TDK	C2012X7R1C105K	1
C_{in2} , C_{O1}	4.7 μF , X5R, 6.3V	0805	TDK	C2012X5R0J475K	2
C_{in3} , C_{O2}	22 μF , X5R, 16V	1210	TDK	C3225X5R1C226M	2
C_{in4}	47 μF , X5R, 6.3V	1210	TDK	C3225X5R0J476M	1
C_{in5}	220 μF , 10V, AL-Elec	E	Panasonic	EEE1AA221AP	1
C_{O3}	100 μF , X5R, 6.3V	1812	TDK	C4532X5R0J107M	1
R_{fbt}	75 $k\Omega$	0805	Vishay Dale	CRCW080575K0FKEA	1
R_{fbb}	34.8 $k\Omega$	0805	Vishay Dale	CRCW080534K8FKEA	1
R_{comp}	1.1 $k\Omega$	0805	Vishay Dale	CRCW08051K10FKEA	1
C_{comp}	180 pF, $\pm 5\%$, C0G, 50V	0603	TDK	C1608C0G1H181J	1
R_{en1}	100 $k\Omega$	0805	Vishay Dale	CRCW0805100KFKEA	1
C_{SS}	10 nF, $\pm 5\%$, C0G, 50V	0805	TDK	C2012C0G1H103J	1

TABLE 2. Output Voltage Setting ($R_{fbt} = 75 k\Omega$)

V_{OUT}	R_{fbb}
3.3 V	23.7 $k\Omega$
2.5 V	34.8 $k\Omega$
1.8 V	59 $k\Omega$
1.5 V	84.5 $k\Omega$
1.2 V	150 $k\Omega$
0.9 V	590 $k\Omega$

Complete Circuit Schematic

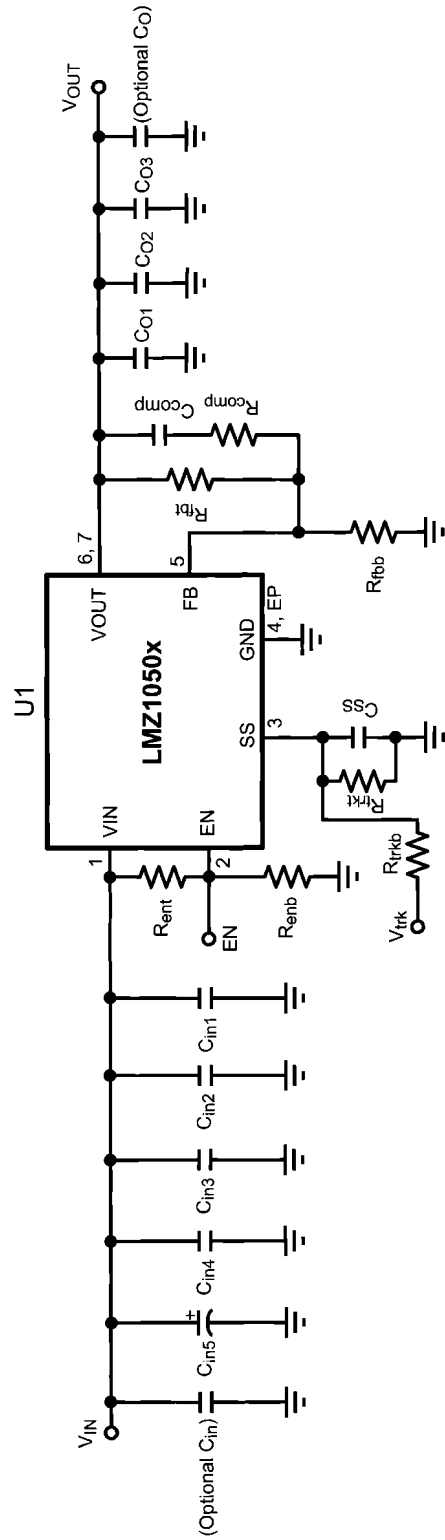

30111324

FIGURE 2. Complete Evaluation Board Schematic

Connection Diagram

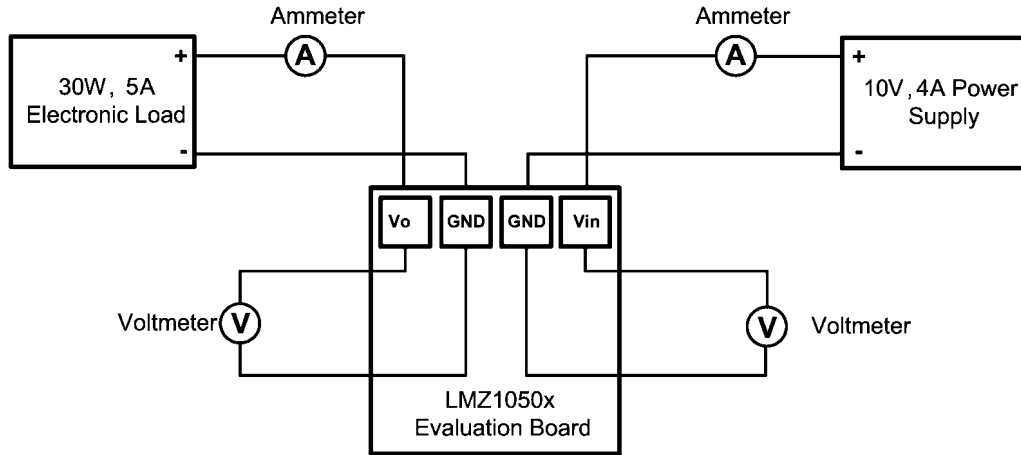

30111315

FIGURE 3. Efficiency Measurement Setup

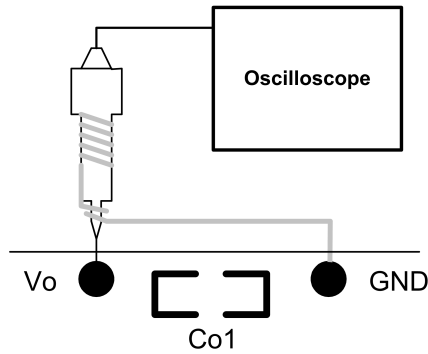

30111316

FIGURE 4. Output Voltage Ripple Measurement Setup

Efficiency vs. Load Current
LMZ10504 & LMZ10505, $V_{OUT} = 2.5V$, $T_{AMB} = 25^{\circ}C$

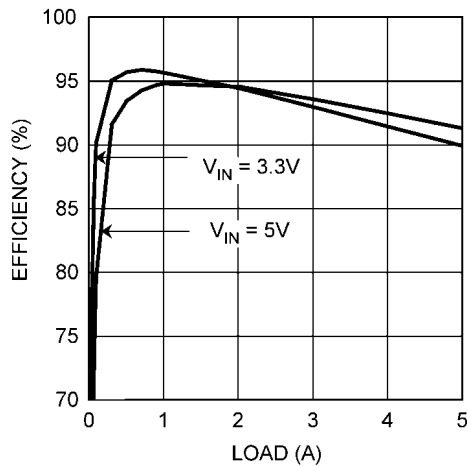

30111328

Efficiency vs. Load Current
LMZ10503, $V_{OUT} = 2.5V$, $T_{AMB} = 25^{\circ}C$

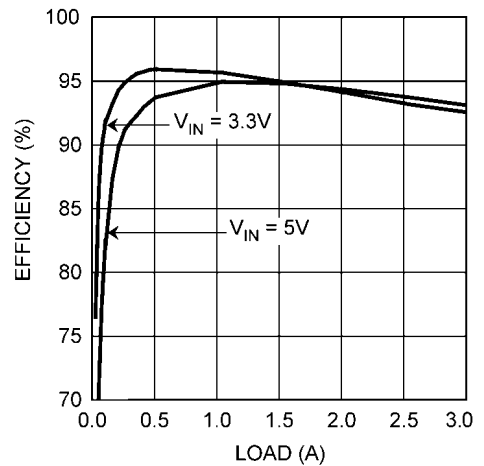

30111331

Performance Characteristics

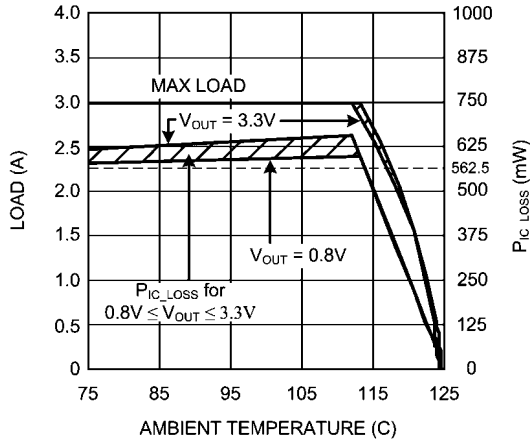

30111329

FIGURE 5. Current Derating vs. Ambient Temperature LMZ10503, $V_{IN} = 5.0V$, $\theta_{JA} = 20^{\circ}C/W$

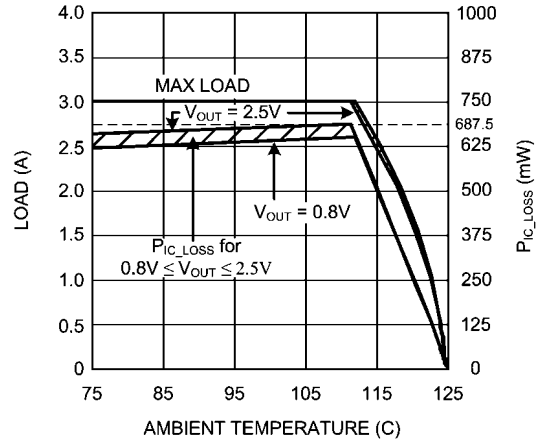

30111330

FIGURE 8. Current Derating vs. Ambient Temperature LMZ10503, $V_{IN} = 3.3V$, $\theta_{JA} = 20^{\circ}C/W$

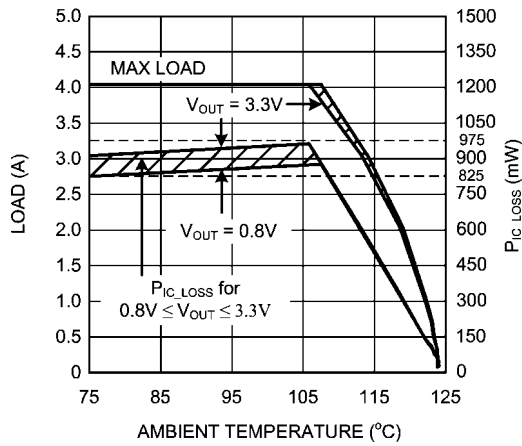

30111322

FIGURE 6. Current Derating vs. Ambient Temperature LMZ10504, $V_{IN} = 5.0V$, $\theta_{JA} = 20^{\circ}C/W$

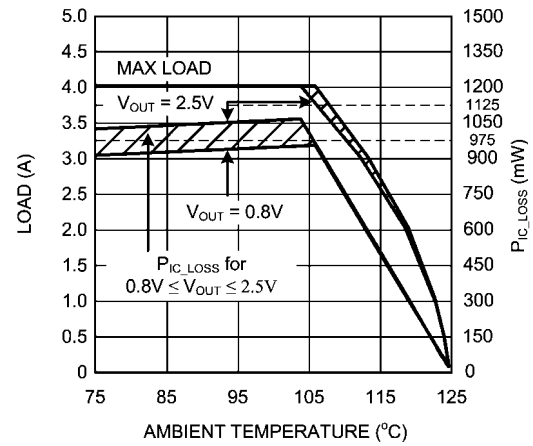

30111323

FIGURE 9. Current Derating vs. Ambient Temperature LMZ10504, $V_{IN} = 3.3V$, $\theta_{JA} = 20^{\circ}C/W$

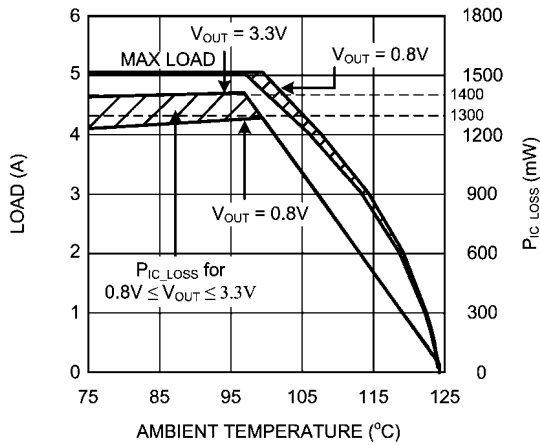

30111332

FIGURE 7. Current Derating vs. Ambient Temperature LMZ10505, $V_{IN} = 5.0V$, $\theta_{JA} = 20^{\circ}C/W$

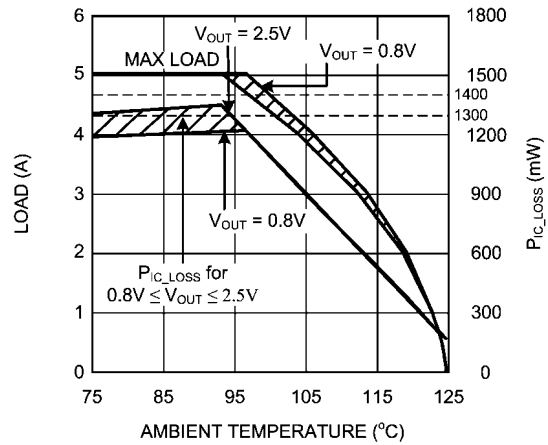

30111333

FIGURE 10. Current Derating vs. Ambient Temperature LMZ10505, $V_{IN} = 3.3V$, $\theta_{JA} = 20^{\circ}C/W$

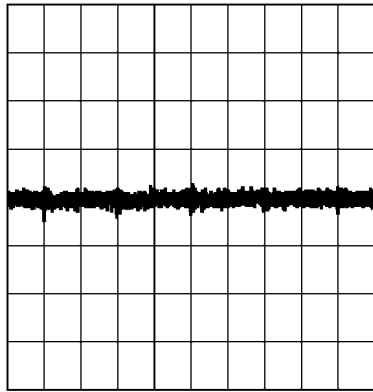

500 ns/DIV

30111318

FIGURE 11. Output Voltage Ripple
 $V_{IN} = 5V$, $V_{OUT} = 2.5V$, $I_{OUT} = 3A, 4A, \& 5A$
 LMZ10503 / LMZ10504 / LMZ10505

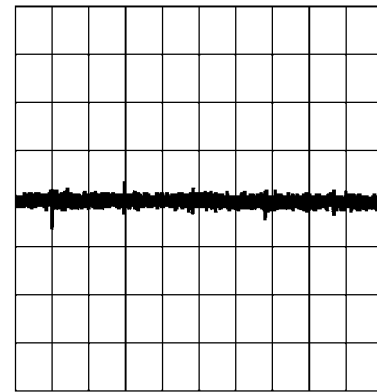

500 ns/DIV

30111320

FIGURE 14. Output Voltage Ripple
 $V_{IN} = 3.3V$, $V_{OUT} = 2.5V$, $I_{OUT} = 3A, 4A, \& 5A$
 LMZ10503 / LMZ10504 / LMZ10505

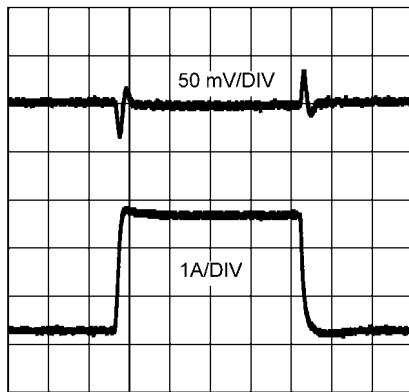

100 μs/DIV

30111337

FIGURE 12. Load Transient Response
 $V_{IN} = 5.0V$, $V_{OUT} = 2.5V$
 LMZ10503, $I_{OUT} = 400\text{ mA to }2.7A$, 20 MHz Bandwidth Limit

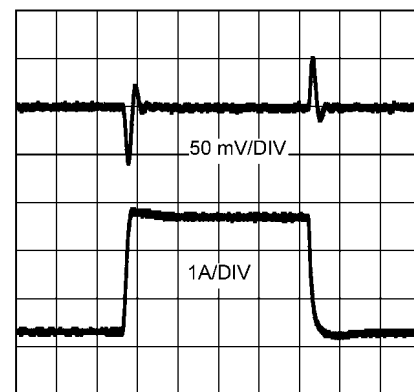

100 μs/DIV

30111336

FIGURE 15. Load Transient Response
 $V_{IN} = 3.3V$, $V_{OUT} = 2.5V$
 LMZ10503, $I_{OUT} = 300\text{ mA to }2.7A$, 20 MHz Bandwidth Limit

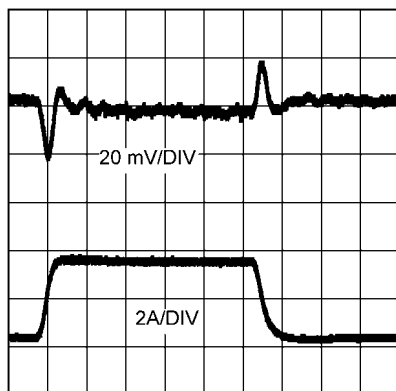

50 μs/DIV

30111319

FIGURE 13. Load Transient Response
 $V_{IN} = 5V$, $V_{OUT} = 2.5V$
 LMZ10504, $I_{OUT} = 400\text{ mA to }3.6A$, 20 MHz Bandwidth Limit

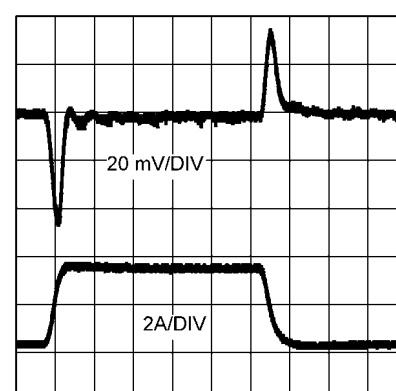

50 μs/DIV

30111321

FIGURE 16. Load Transient Response
 $V_{IN} = 3.3V$, $V_{OUT} = 2.5V$
 LMZ10504, $I_{OUT} = 400\text{ mA to }3.6A$, 20 MHz Bandwidth Limit

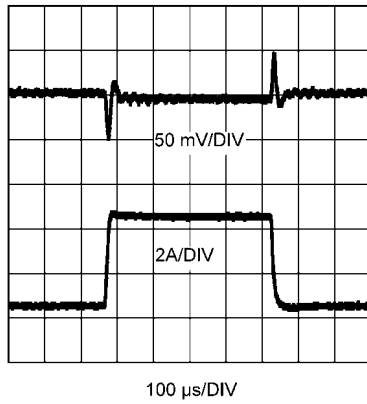
100 μ s/DIV

30111335

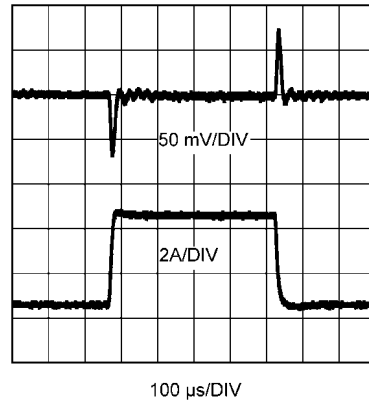
FIGURE 17. Load Transient Response $V_{IN} = 5.0V$, $V_{OUT} = 2.5V$ LMZ10505, $I_{OUT} = 500\text{ mA}$ to 4.5A, 20 MHz Bandwidth Limit100 μ s/DIV

30111334

FIGURE 18. Load Transient Response $V_{IN} = 3.3V$, $V_{OUT} = 2.5V$ LMZ10505, $I_{OUT} = 500\text{ mA}$ to 4.5A, 20 MHz Bandwidth Limit

Circuit Example: Complies with EN55022 Class B Radiated Emissions

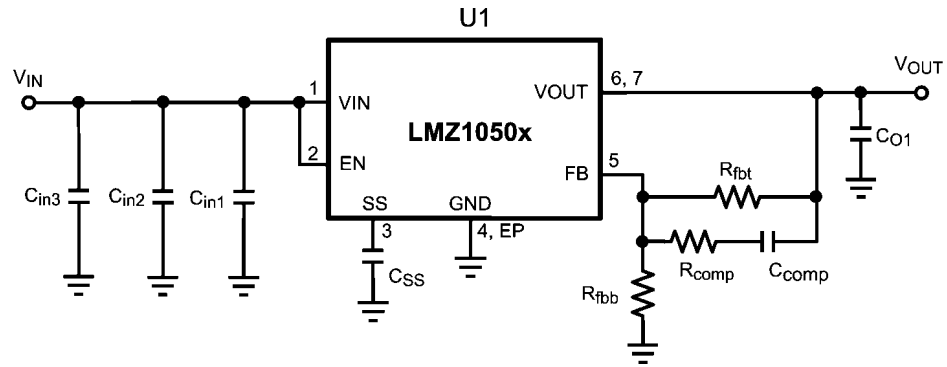

30111325

FIGURE 19. Component Schematic, $V_{IN} = 5V$, $V_{OUT} = 2.5V$, Complies with EN55022 Class B Radiated Emissions

TABLE 3. Bill of Materials

Designator	Description	Case Size	Manufacturer	Manufacturer P/N	Quantity
U1	SIMPLE SWITCHER®	TO-PMOD-7	National Semiconductor	LMZ10503/4/05TZ-ADJ	1
C_{in1}	1 μF , X7R, 16V	0805	TDK	C2012X7R1C105K	1
C_{in2}	4.7 μF , X5R, 6.3V	0805	TDK	C2012X5R0J475K	1
C_{in3}	47 μF , X5R, 6.3V	1210	TDK	C3225X5R0J476M	1
C_{O1}	100 μF , X5R, 6.3V	1812	TDK	C4532X5R0J107M	1
R_{fbt}	75 $k\Omega$	0805	Vishay Dale	CRCW080575K0FKEA	1
R_{fbb}	34.8 $k\Omega$	0805	Vishay Dale	CRCW080534K8FKEA	1
R_{comp}	1.1 $k\Omega$	0805	Vishay Dale	CRCW08051K10FKEA	1
C_{comp}	180 pF, $\pm 5\%$, C0G, 50V	0603	TDK	C1608C0G1H181J	1
C_{SS}	10 nF, $\pm 5\%$, C0G, 50V	0805	TDK	C2012C0G1H103J	1

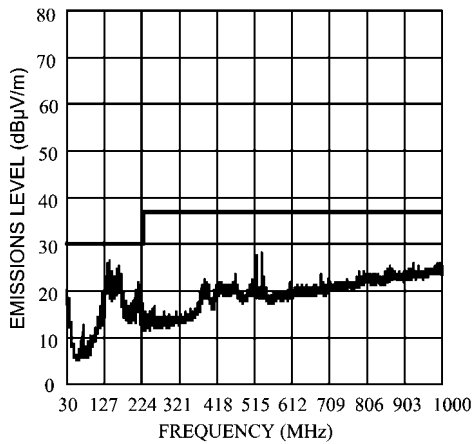

30111338

FIGURE 20. Radiated Emissions (EN55022, Class B)
 $V_{IN} = 5V$, $V_{OUT} = 2.5V$, $I_{OUT} = 3A$
 Tested on LMZ10503 Evaluation Board

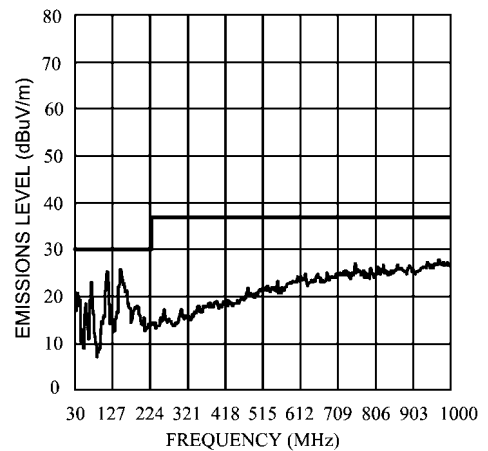

30111326

FIGURE 21. Radiated Emissions (EN55022, Class B)
 $V_{IN} = 5V$, $V_{OUT} = 2.5V$, $I_{OUT} = 4A$
 Tested on LMZ10504 Evaluation Board

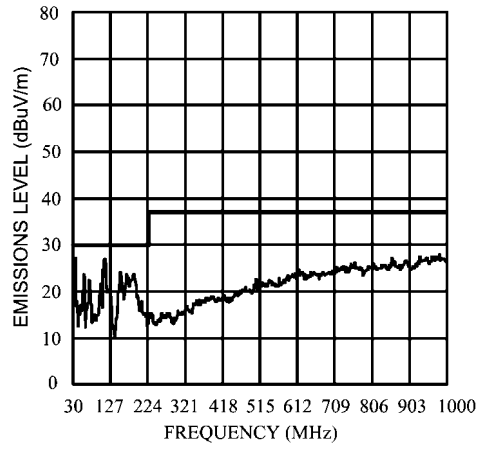

30111327

FIGURE 22. Radiated Emissions (EN55022, Class B)
 $V_{IN} = 5V$, $V_{OUT} = 2.5V$, $I_{OUT} = 5A$
Tested on LMZ10505 Evaluation Board

PCB Layout Diagram

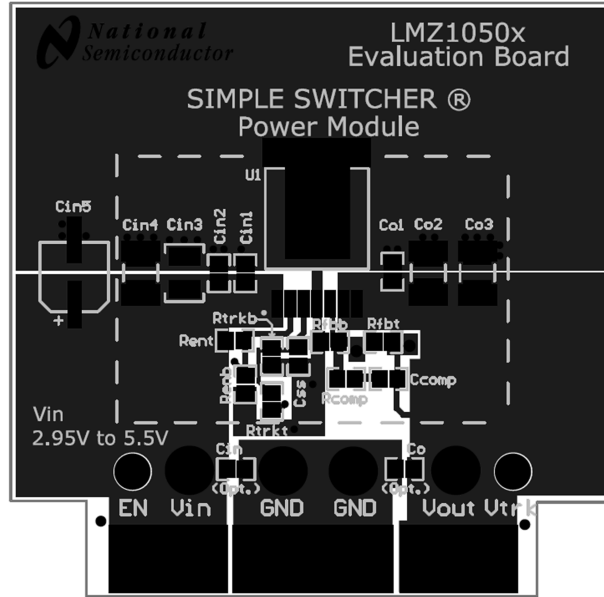

30111307

FIGURE 23. Top Layer

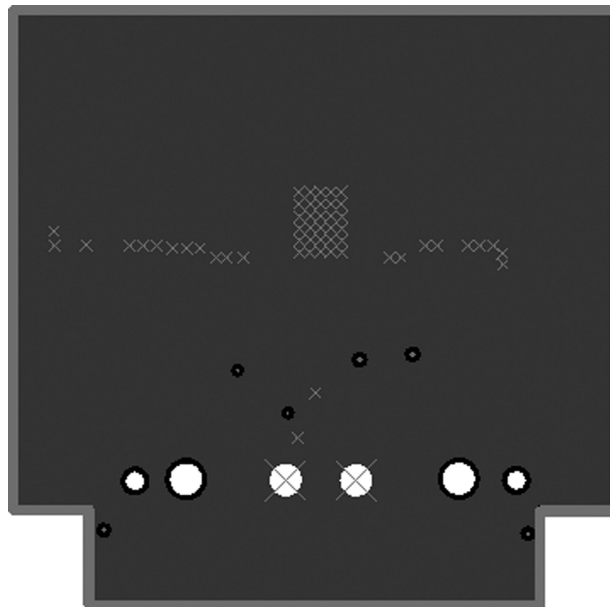

30111308

FIGURE 24. Internal Layer I (Ground)

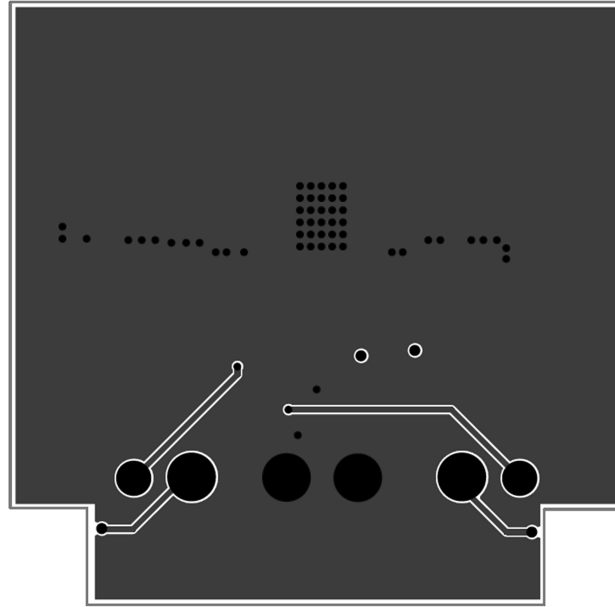

30111311

FIGURE 25. Internal Layer II (Ground)

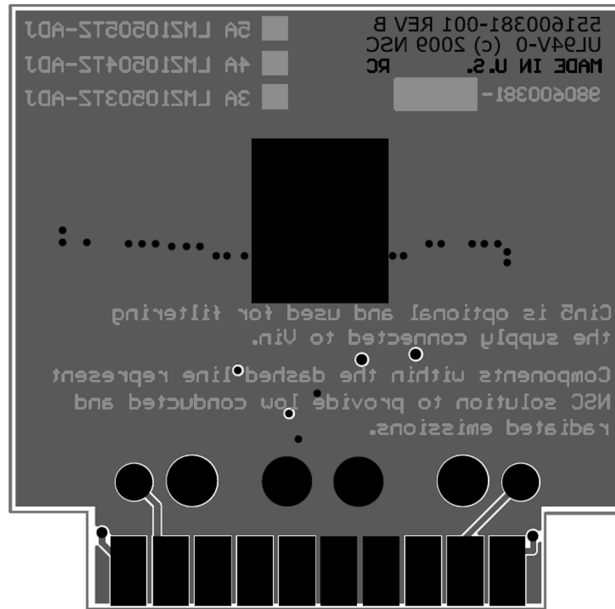

30111313

FIGURE 26. Bottom Layer

For more National Semiconductor product information and proven design tools, visit the following Web sites at:
www.national.com

Products		Design Support	
Amplifiers	www.national.com/amplifiers	WEBENCH® Tools	www.national.com/webench
Audio	www.national.com/audio	App Notes	www.national.com/appnotes
Clock and Timing	www.national.com/timing	Reference Designs	www.national.com/refdesigns
Data Converters	www.national.com/adc	Samples	www.national.com/samples
Interface	www.national.com/interface	Eval Boards	www.national.com/evalboards
LVDS	www.national.com/lvds	Packaging	www.national.com/packaging
Power Management	www.national.com/power	Green Compliance	www.national.com/quality/green
Switching Regulators	www.national.com/switchers	Distributors	www.national.com/contacts
LDOs	www.national.com/lido	Quality and Reliability	www.national.com/quality
LED Lighting	www.national.com/led	Feedback/Support	www.national.com/feedback
Voltage References	www.national.com/vref	Design Made Easy	www.national.com/easy
PowerWise® Solutions	www.national.com/powerwise	Applications & Markets	www.national.com/solutions
Serial Digital Interface (SDI)	www.national.com/sdi	Mil/Aero	www.national.com/milaero
Temperature Sensors	www.national.com/tempensors	SolarMagic™	www.national.com/solarmagic
PLL/VCO	www.national.com/wireless	PowerWise® Design University	www.national.com/training

THE CONTENTS OF THIS DOCUMENT ARE PROVIDED IN CONNECTION WITH NATIONAL SEMICONDUCTOR CORPORATION ("NATIONAL") PRODUCTS. NATIONAL MAKES NO REPRESENTATIONS OR WARRANTIES WITH RESPECT TO THE ACCURACY OR COMPLETENESS OF THE CONTENTS OF THIS PUBLICATION AND RESERVES THE RIGHT TO MAKE CHANGES TO SPECIFICATIONS AND PRODUCT DESCRIPTIONS AT ANY TIME WITHOUT NOTICE. NO LICENSE, WHETHER EXPRESS, IMPLIED, ARISING BY ESTOPPEL OR OTHERWISE, TO ANY INTELLECTUAL PROPERTY RIGHTS IS GRANTED BY THIS DOCUMENT.

TESTING AND OTHER QUALITY CONTROLS ARE USED TO THE EXTENT NATIONAL DEEMS NECESSARY TO SUPPORT NATIONAL'S PRODUCT WARRANTY. EXCEPT WHERE MANDATED BY GOVERNMENT REQUIREMENTS, TESTING OF ALL PARAMETERS OF EACH PRODUCT IS NOT NECESSARILY PERFORMED. NATIONAL ASSUMES NO LIABILITY FOR APPLICATIONS ASSISTANCE OR BUYER PRODUCT DESIGN. BUYERS ARE RESPONSIBLE FOR THEIR PRODUCTS AND APPLICATIONS USING NATIONAL COMPONENTS. PRIOR TO USING OR DISTRIBUTING ANY PRODUCTS THAT INCLUDE NATIONAL COMPONENTS, BUYERS SHOULD PROVIDE ADEQUATE DESIGN, TESTING AND OPERATING SAFEGUARDS.

EXCEPT AS PROVIDED IN NATIONAL'S TERMS AND CONDITIONS OF SALE FOR SUCH PRODUCTS, NATIONAL ASSUMES NO LIABILITY WHATSOEVER, AND NATIONAL DISCLAIMS ANY EXPRESS OR IMPLIED WARRANTY RELATING TO THE SALE AND/OR USE OF NATIONAL PRODUCTS INCLUDING LIABILITY OR WARRANTIES RELATING TO FITNESS FOR A PARTICULAR PURPOSE, MERCHANTABILITY, OR INFRINGEMENT OF ANY PATENT, COPYRIGHT OR OTHER INTELLECTUAL PROPERTY RIGHT.

LIFE SUPPORT POLICY

NATIONAL'S PRODUCTS ARE NOT AUTHORIZED FOR USE AS CRITICAL COMPONENTS IN LIFE SUPPORT DEVICES OR SYSTEMS WITHOUT THE EXPRESS PRIOR WRITTEN APPROVAL OF THE CHIEF EXECUTIVE OFFICER AND GENERAL COUNSEL OF NATIONAL SEMICONDUCTOR CORPORATION. As used herein:

Life support devices or systems are devices which (a) are intended for surgical implant into the body, or (b) support or sustain life and whose failure to perform when properly used in accordance with instructions for use provided in the labeling can be reasonably expected to result in a significant injury to the user. A critical component is any component in a life support device or system whose failure to perform can be reasonably expected to cause the failure of the life support device or system or to affect its safety or effectiveness.

National Semiconductor and the National Semiconductor logo are registered trademarks of National Semiconductor Corporation. All other brand or product names may be trademarks or registered trademarks of their respective holders.

Copyright© 2010 National Semiconductor Corporation

For the most current product information visit us at www.national.com



National Semiconductor Americas Technical Support Center
 Email: support@nsc.com
 Tel: 1-800-272-9959

National Semiconductor Europe Technical Support Center
 Email: europe.support@nsc.com

National Semiconductor Asia Pacific Technical Support Center
 Email: ap.support@nsc.com

National Semiconductor Japan Technical Support Center
 Email: jpn.feedback@nsc.com