

# LMZ1420x / LMZ1200x Evaluation Board

National Semiconductor  
Application Note 2024  
Alan Martin  
March 26, 2010



## Introduction

The LMZ1420x and LMZ1200x SIMPLE SWITCHER® power modules are easy-to-use DC-DC solution capable of driving up to a 3A load with exceptional power conversion efficiency, output voltage accuracy, line and load regulation. They are available in an innovative package that enhances thermal performance and allows for hand or machine soldering.

The LMZ14203/2/1 can accept an input voltage rail between 6V and 42V and the LMZ12003/2/1 can accept an input voltage rail between 4.5V and 20V. The devices can deliver an adjustable and highly accurate output voltage as low as 0.8V and as high as 6V. The control structure is constant on-time with input voltage feed forward. This creates a nearly constant switching frequency across the input voltage range. The control loop operates well with low ESR output capacitors such as ceramics. An output feed-forward capacitor across the upper feedback resistor trims for optimum transient response. The precision enable input allows for programmable UVLO of the input supply. The external soft-start capacitor facilitates controlled startup output rise time. The LMZ1420x and LMZ1200x family is a reliable and robust solution with the following features: lossless cycle-by-cycle valley current limit to protect for over current or short-circuit fault, thermal shut-down, input under-voltage lock-out, and will start up into a pre-biased output.

## Board Specifications

- LMZ1420x  $V_{IN} = 6V$  to 42V
- LMZ1420x enable UVLO = 8V
- LMZ1420x  $V_{OUT} = 3.3V$
- LMZ1200x  $V_{IN} = 4.5V$  to 20V
- LMZ1200x enable UVLO = 4.5V
- LMZ1200x  $V_{OUT} = 1.8V$
- Operates at full load up to 80°C ambient at 12V input
- $\theta_{JA} = 20^{\circ}C / W$ ,  $\theta_{JC} = 1.9^{\circ}C / W$
- Designed on four layers, all four layers are 1 oz. copper weight
- The two internal ground planes are identical
- Measures 1.705 in. x 3.03 in. (4.33 cm x 7.7cm) and is 62mil (.062") thick of FR4 laminate material

For additional circuit modifications refer to the Design Consideration section of the LMZ1420x or LMZ1200x data sheet. For negative output voltage connections see AN-2027.

## Additional Footprints

Additional component mounting pads are available to experiment with alternative  $C_{in}$  and  $C_{out}$  combinations or a zener clamp on the enable input. See Figure 6 for corresponding schematic locations.

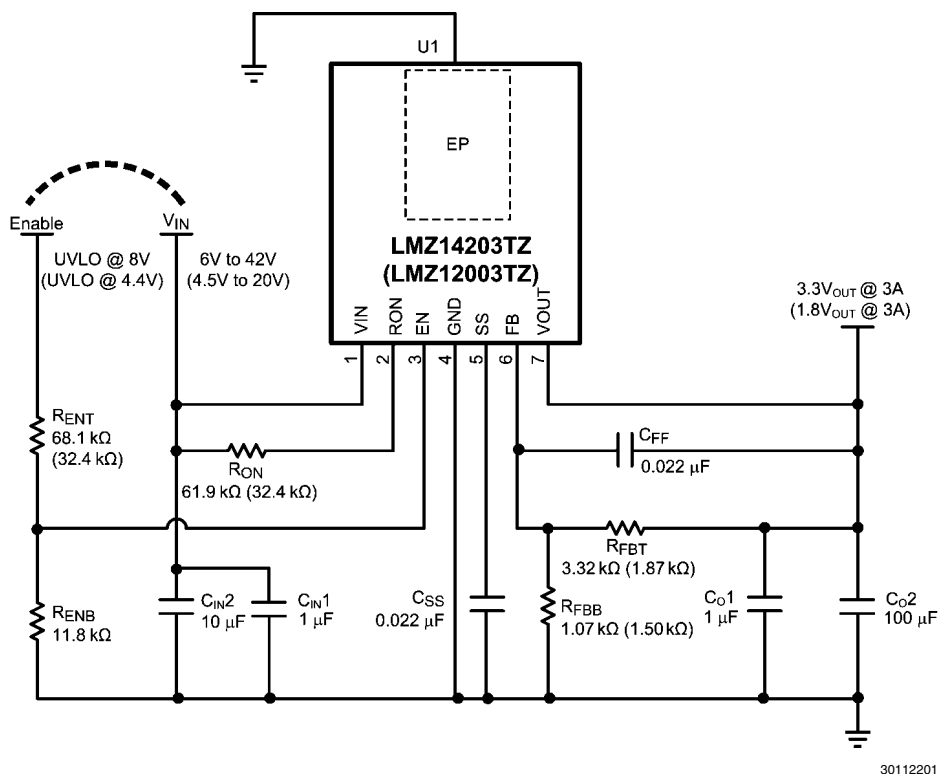

FIGURE 1. Evaluation Board Schematic  
(LMZ12003 1.8V application values shown in parentheses)

TABLE 1. LMZ1420x Bill of Materials,  $V_{IN} = 8V$  to  $42V$ ,  $V_{OUT} = 3.3V$ ,  $I_{OUT(MAX)} = 3A / 2A / 1A$ 

Designator	Description	Case Size	Manufacturer	Manufacturer P/N	Quantity
U1	SIMPLE SWITCHER®	TO-PMOD-7	National Semiconductor	LMZ14203TZ-ADJ or LMZ14202TZ-ADJ or LMZ14201TZ-ADJ	1
$C_{IN4}, C_{O1}$	1 $\mu F$ , X7R, 50V	1206	Taiyo Yuden	UMK316B7105KL-T	2
$C_{IN2}$	10 $\mu F$ , X5R, 50V	1210	Taiyo Yuden	UMK325BJ106MM-T	1
$C_{O2}$	100 $\mu F$ , X5R, 6.3V	1210	Taiyo Yuden	JMK325BJ107MM-T	1
$C_{SS}, C_{FF}$	0.022 $\mu F$ , X7R, 100V	0805	AVX	08051C223JAT2A	2
$R_{ENB}$	11.8k	0805	Panasonic	ERJ-6ENF1182V	1
$R_{ENT}$	68.1 k $\Omega$	0805	Panasonic	ERJ-6ENF6812V	1
$R_{FBT}$	3.32 k $\Omega$	0805	Vishay-Dale	CRCW08053K32FKEA	1
$R_{FBB}$	1.07 k $\Omega$	0805	Panasonic	CRCW080534K8FKEA	1
$R_{ON}$	61.9 k $\Omega$	0805	Panasonic	ERJ-6ENF6192V	1

TABLE 2. LMZ1200x Bill of Materials,  $V_{IN} = 4.5$  to  $20V$ ,  $V_{OUT} = 1.8V$ ,  $I_{OUT(MAX)} = 3A / 2A / 1A$ 

Designator	Description	Case Size	Manufacturer	Manufacturer P/N	Quantity
U1	SIMPLE SWITCHER®	TO-PMOD-7	National Semiconductor	LMZ12003TZ-ADJ or LMZ12002TZ-ADJ or LMZ12001TZ-ADJ	1
$C_{IN4}, C_{O1}$	1 $\mu F$ , X7R, 50V	1206	Taiyo Yuden	UMK316B7105KL-T	2
$C_{IN2}$	10 $\mu F$ , X5R, 50V	1210	Taiyo Yuden	UMK325BJ106MM-T	1
$C_{O2}$	100 $\mu F$ , X5R, 6.3V	1210	Taiyo Yuden	JMK325BJ107MM-T	1
$C_{SS}, C_{FF}$	0.022 $\mu F$ , X7R, 100V	0805	AVX	08051C223JAT2A	2
$R_{ENB}$	11.8k	0805	Panasonic	ERJ-6ENF1182V	1
$R_{ENT}$	32.4K $\Omega$	0805	Panasonic	ERJ-6ENF3242V	1
$R_{FBT}$	1.87 k $\Omega$	0805	Vishay-Dale	CRCW08051K87FKEA	1
$R_{FBB}$	1.50 k $\Omega$	0805	Panasonic	CRCW08051K50FKEA	1
$R_{ON}$	32.4K $\Omega$	0805	Panasonic	ERJ-6ENF3242V	1

## Performance Characteristics

LMZ14203 Load Regulation

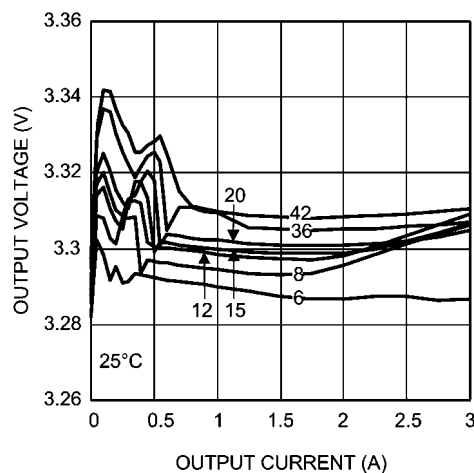

LMZ12003 Load Regulation

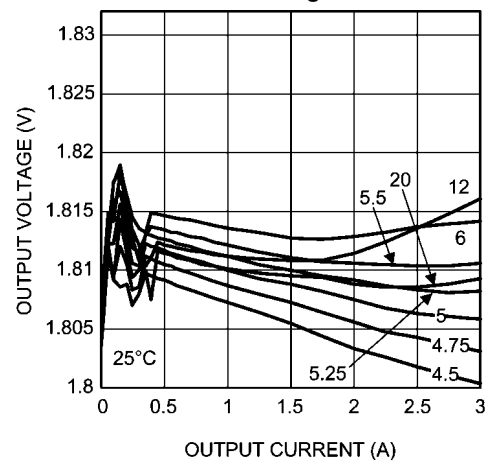

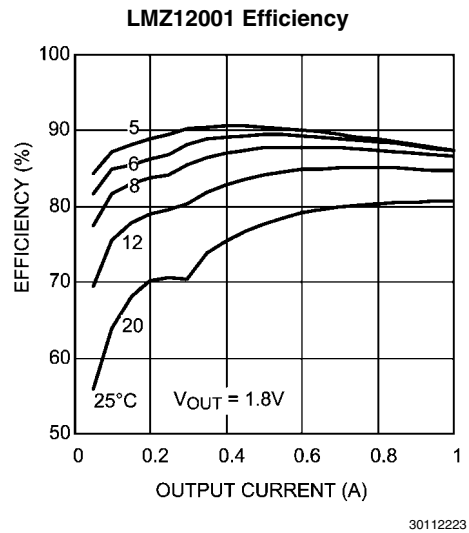
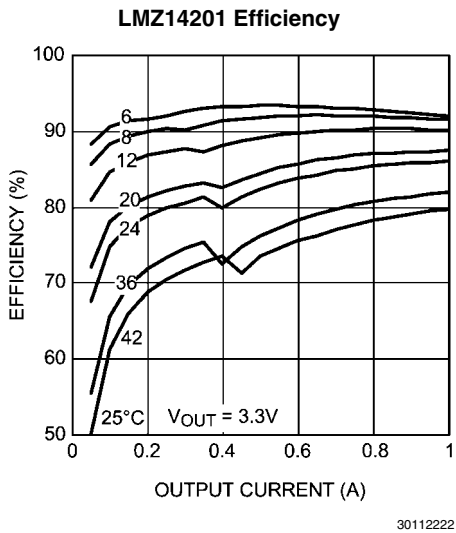
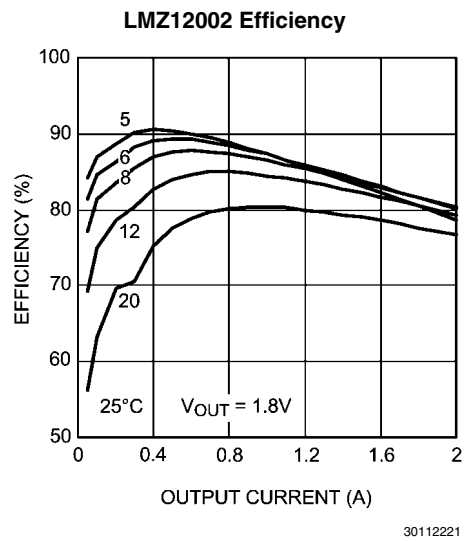
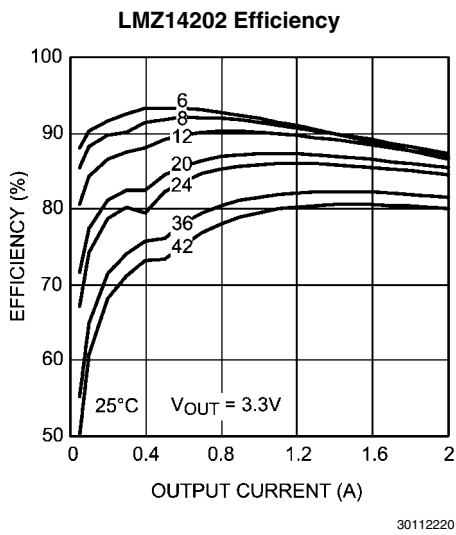
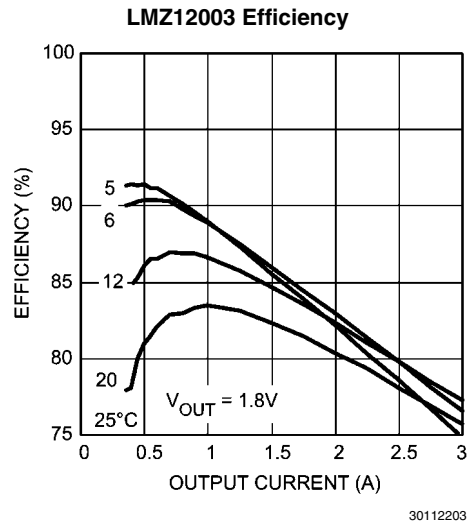
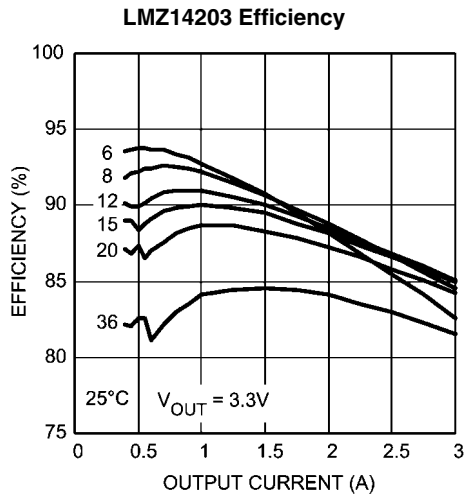

**LMZ14203 Thermal Derating**

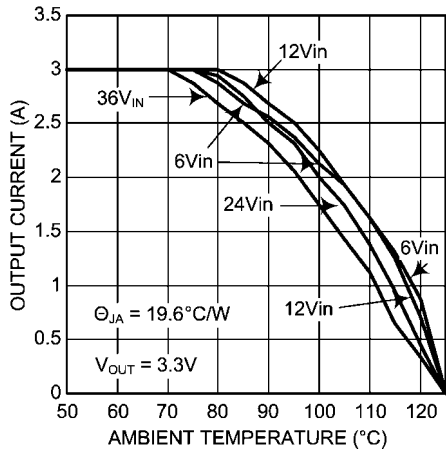

30112215

**LMZ12003 Thermal Derating**

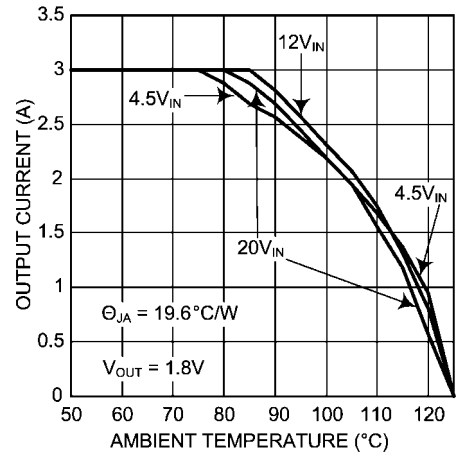

30112216

**LMZ14202 Thermal Derating**

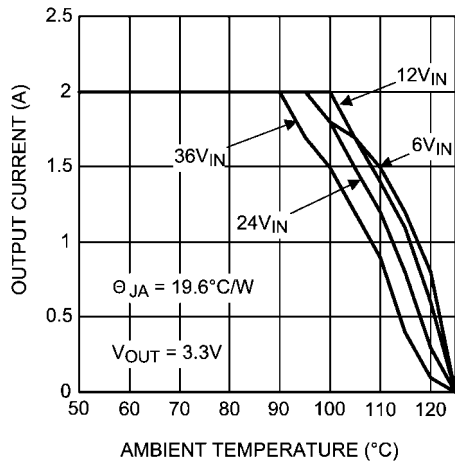

30112224

**LMZ12002 Thermal Derating**

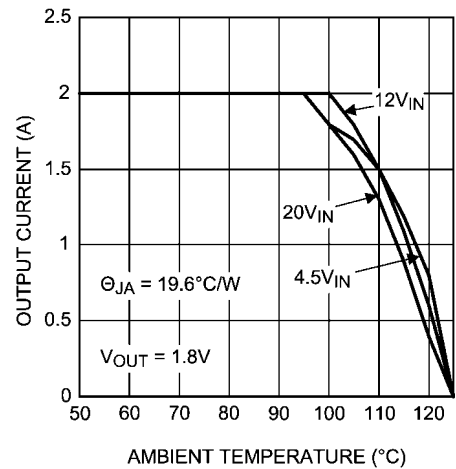

30112225

**LMZ14201 Thermal Derating**

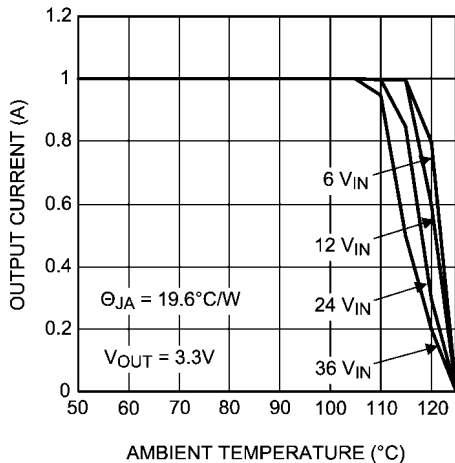

30112226

**LMZ12001 Thermal Derating**

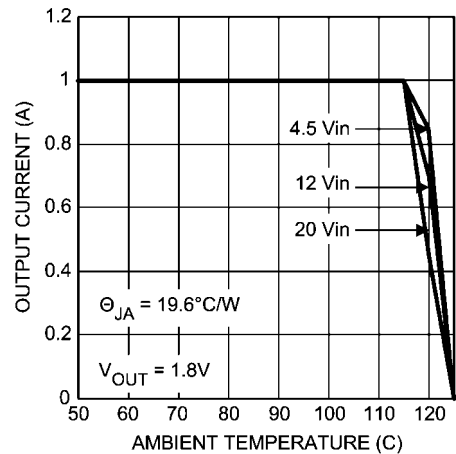

30112227

**LMZ14203 Current Limit  $V_{OUT} = 3.3V$**

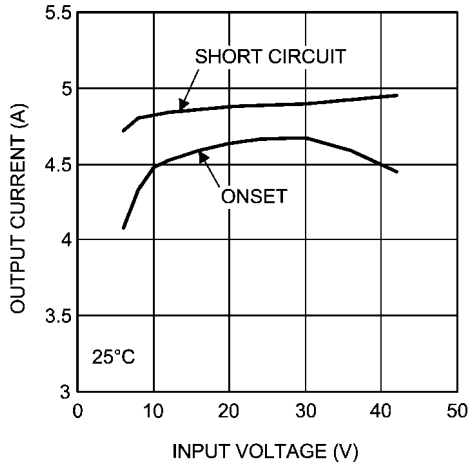

30112228

**LMZ12003 Current Limit  $V_{OUT} = 1.8V$**

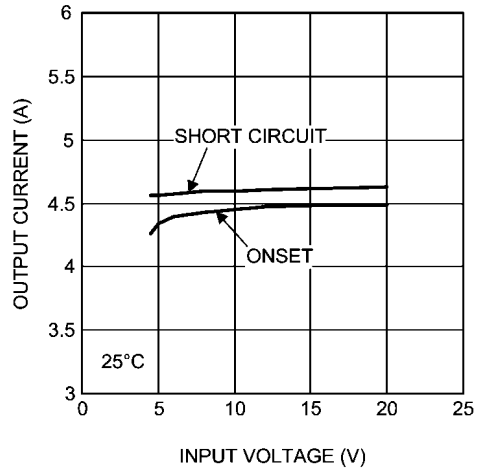

30112229

**LMZ14202 Current Limit  $V_{OUT} = 3.3V$**

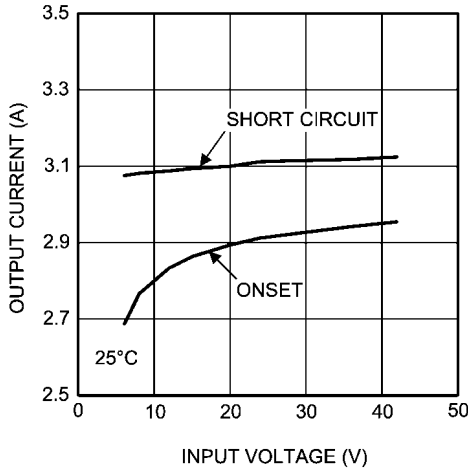

30112230

**LMZ12002 Current Limit  $V_{OUT} = 1.8V$**

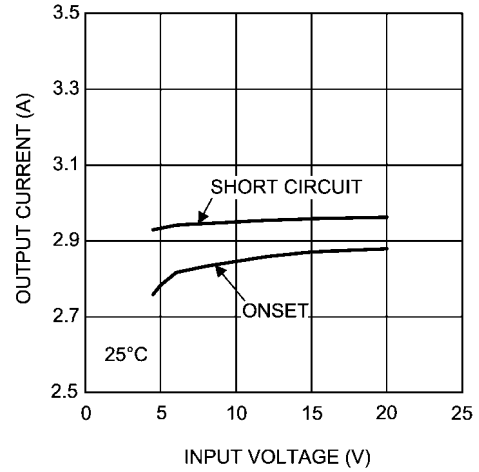

30112231

**LMZ14201 Current Limit  $V_{OUT} = 3.3V$**

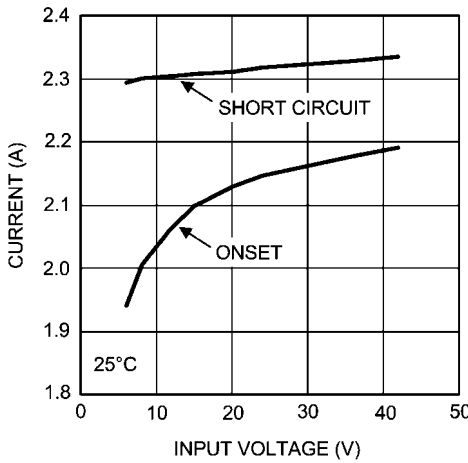

30112232

**LMZ12001 Current Limit  $V_{OUT} = 1.8V$**

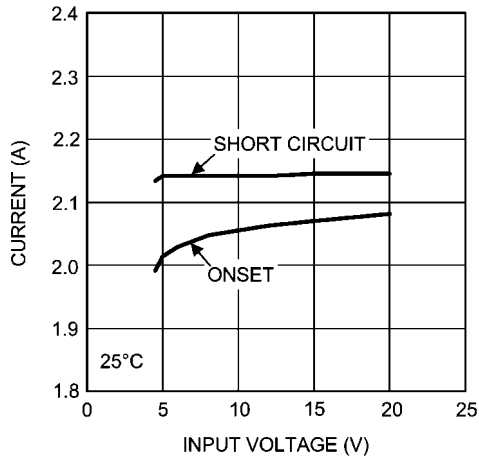

30112233

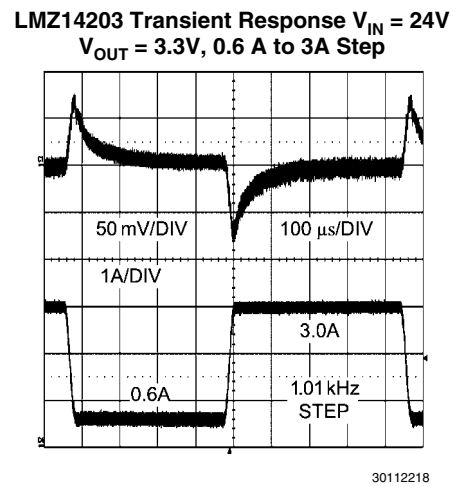
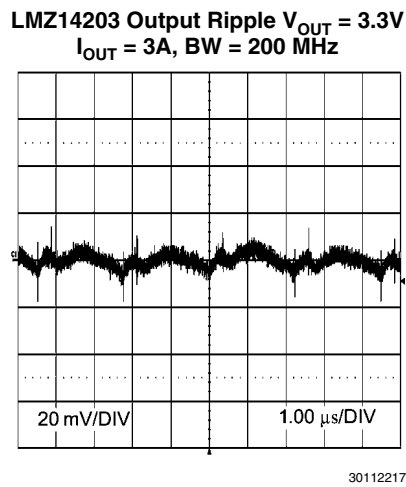
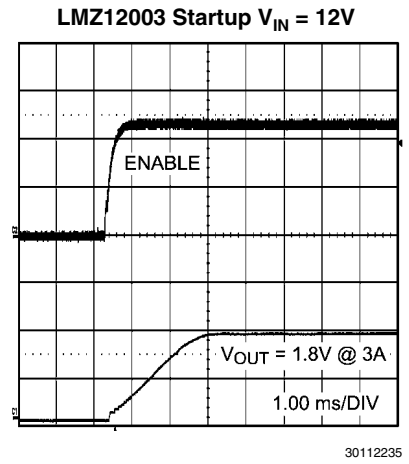
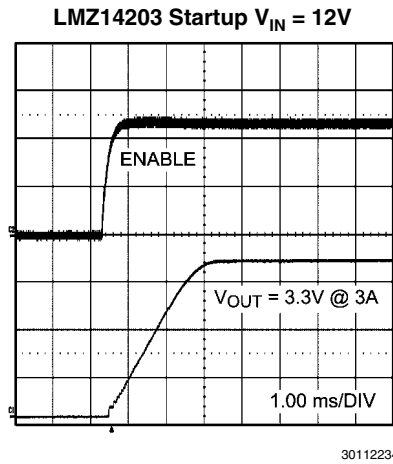

## PCB Layout Diagrams

Gerber and CAD files can be download from the LMZ14203 product folder.

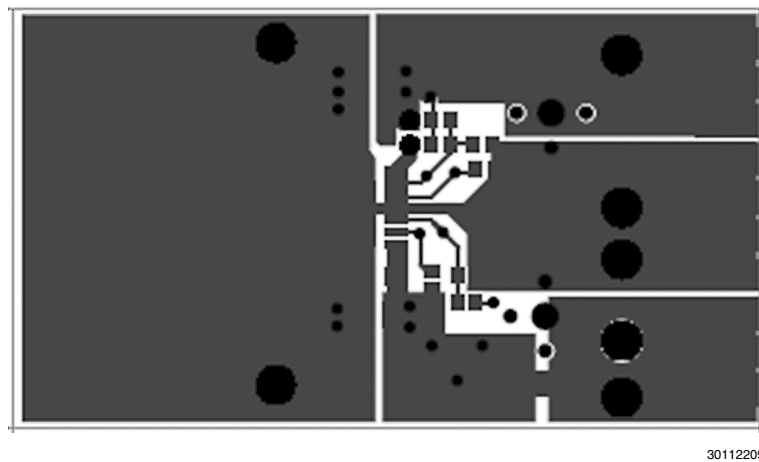
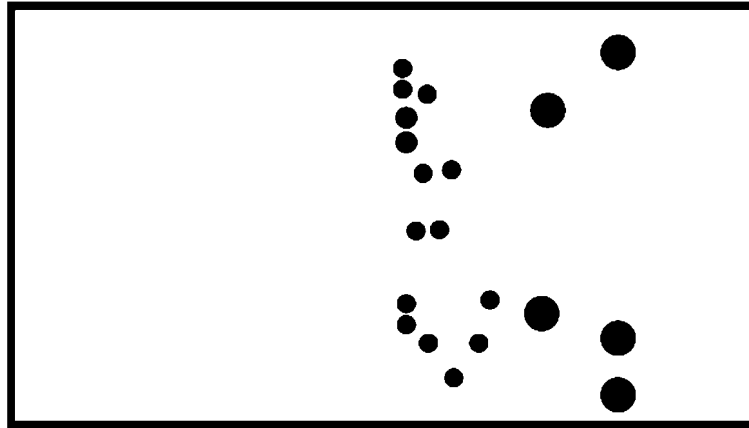
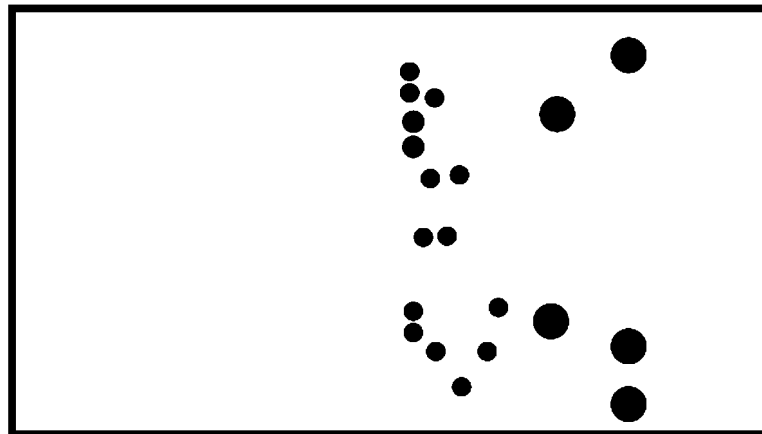

FIGURE 2. Top Layer



30112210

**FIGURE 3. Internal Layer I (Ground)  
Heat Sinking Layer**



30112211

**FIGURE 4. Internal Layer II (Ground)  
Heat Sinking Layer**

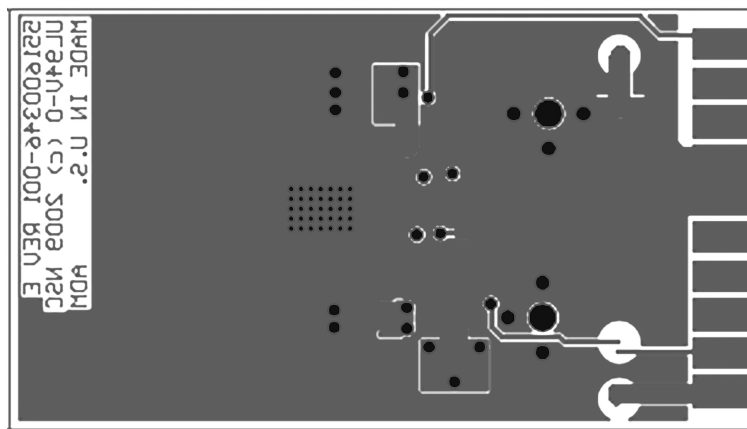

30112212

**FIGURE 5. Bottom Layer (Ground and Routing)  
Heat Sinking Layer**

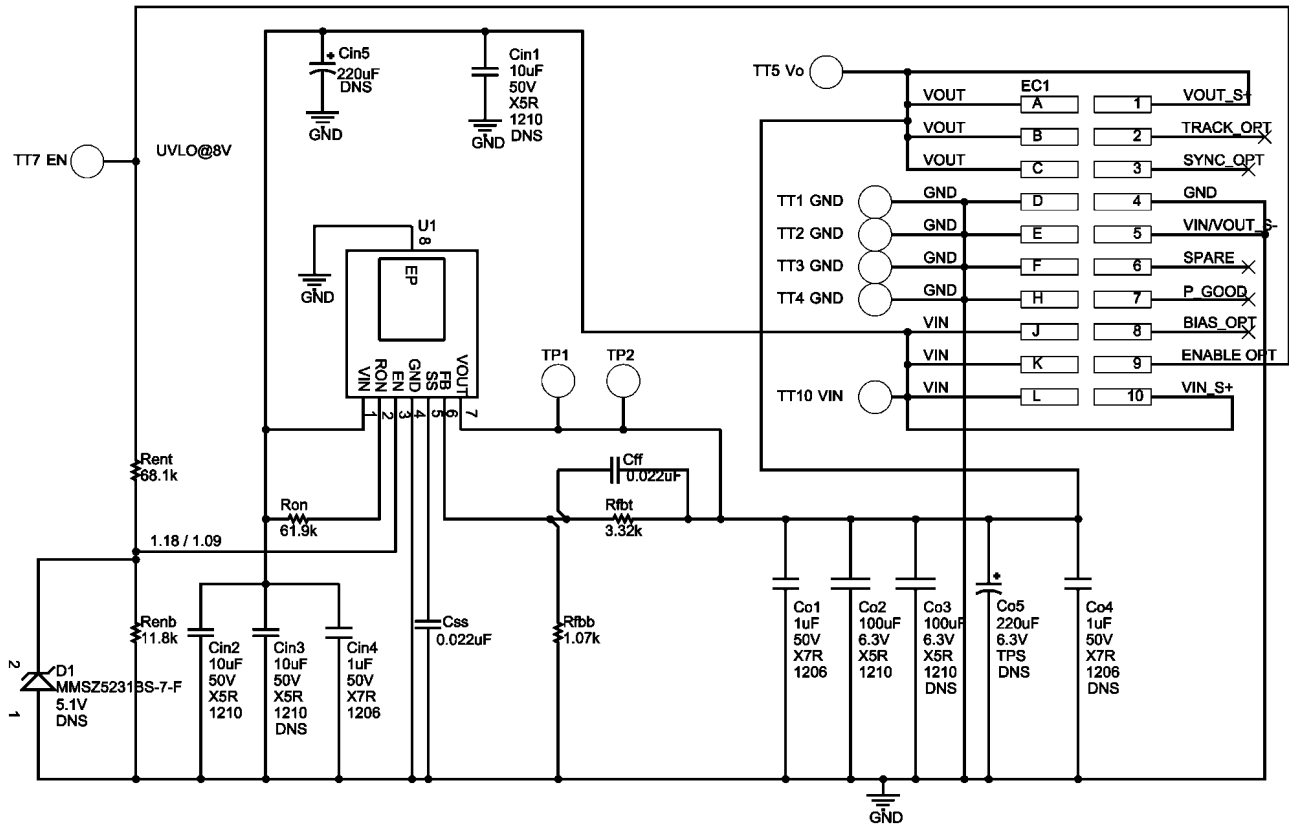

30112213

FIGURE 6. LMZ14203 PCB CAD package schematic  
DNS = Component not installed



# Notes

AN-2024

## Notes

For more National Semiconductor product information and proven design tools, visit the following Web sites at:  
[www.national.com](http://www.national.com)

Products		Design Support	
Amplifiers	<a href="http://www.national.com/amplifiers">www.national.com/amplifiers</a>	WEBENCH® Tools	<a href="http://www.national.com/webench">www.national.com/webench</a>
Audio	<a href="http://www.national.com/audio">www.national.com/audio</a>	App Notes	<a href="http://www.national.com/appnotes">www.national.com/appnotes</a>
Clock and Timing	<a href="http://www.national.com/timing">www.national.com/timing</a>	Reference Designs	<a href="http://www.national.com/refdesigns">www.national.com/refdesigns</a>
Data Converters	<a href="http://www.national.com/adc">www.national.com/adc</a>	Samples	<a href="http://www.national.com/samples">www.national.com/samples</a>
Interface	<a href="http://www.national.com/interface">www.national.com/interface</a>	Eval Boards	<a href="http://www.national.com/evalboards">www.national.com/evalboards</a>
LVDS	<a href="http://www.national.com/lvds">www.national.com/lvds</a>	Packaging	<a href="http://www.national.com/packaging">www.national.com/packaging</a>
Power Management	<a href="http://www.national.com/power">www.national.com/power</a>	Green Compliance	<a href="http://www.national.com/quality/green">www.national.com/quality/green</a>
Switching Regulators	<a href="http://www.national.com/switchers">www.national.com/switchers</a>	Distributors	<a href="http://www.national.com/contacts">www.national.com/contacts</a>
LDOs	<a href="http://www.national.com/lido">www.national.com/lido</a>	Quality and Reliability	<a href="http://www.national.com/quality">www.national.com/quality</a>
LED Lighting	<a href="http://www.national.com/led">www.national.com/led</a>	Feedback/Support	<a href="http://www.national.com/feedback">www.national.com/feedback</a>
Voltage References	<a href="http://www.national.com/vref">www.national.com/vref</a>	Design Made Easy	<a href="http://www.national.com/easy">www.national.com/easy</a>
PowerWise® Solutions	<a href="http://www.national.com/powerwise">www.national.com/powerwise</a>	Applications & Markets	<a href="http://www.national.com/solutions">www.national.com/solutions</a>
Serial Digital Interface (SDI)	<a href="http://www.national.com/sdi">www.national.com/sdi</a>	Mil/Aero	<a href="http://www.national.com/milaero">www.national.com/milaero</a>
Temperature Sensors	<a href="http://www.national.com/tempensors">www.national.com/tempensors</a>	SolarMagic™	<a href="http://www.national.com/solarmagic">www.national.com/solarmagic</a>
PLL/VCO	<a href="http://www.national.com/wireless">www.national.com/wireless</a>	PowerWise® Design University	<a href="http://www.national.com/training">www.national.com/training</a>

THE CONTENTS OF THIS DOCUMENT ARE PROVIDED IN CONNECTION WITH NATIONAL SEMICONDUCTOR CORPORATION ("NATIONAL") PRODUCTS. NATIONAL MAKES NO REPRESENTATIONS OR WARRANTIES WITH RESPECT TO THE ACCURACY OR COMPLETENESS OF THE CONTENTS OF THIS PUBLICATION AND RESERVES THE RIGHT TO MAKE CHANGES TO SPECIFICATIONS AND PRODUCT DESCRIPTIONS AT ANY TIME WITHOUT NOTICE. NO LICENSE, WHETHER EXPRESS, IMPLIED, ARISING BY ESTOPPEL OR OTHERWISE, TO ANY INTELLECTUAL PROPERTY RIGHTS IS GRANTED BY THIS DOCUMENT.

TESTING AND OTHER QUALITY CONTROLS ARE USED TO THE EXTENT NATIONAL DEEMS NECESSARY TO SUPPORT NATIONAL'S PRODUCT WARRANTY. EXCEPT WHERE MANDATED BY GOVERNMENT REQUIREMENTS, TESTING OF ALL PARAMETERS OF EACH PRODUCT IS NOT NECESSARILY PERFORMED. NATIONAL ASSUMES NO LIABILITY FOR APPLICATIONS ASSISTANCE OR BUYER PRODUCT DESIGN. BUYERS ARE RESPONSIBLE FOR THEIR PRODUCTS AND APPLICATIONS USING NATIONAL COMPONENTS. PRIOR TO USING OR DISTRIBUTING ANY PRODUCTS THAT INCLUDE NATIONAL COMPONENTS, BUYERS SHOULD PROVIDE ADEQUATE DESIGN, TESTING AND OPERATING SAFEGUARDS.

EXCEPT AS PROVIDED IN NATIONAL'S TERMS AND CONDITIONS OF SALE FOR SUCH PRODUCTS, NATIONAL ASSUMES NO LIABILITY WHATSOEVER, AND NATIONAL DISCLAIMS ANY EXPRESS OR IMPLIED WARRANTY RELATING TO THE SALE AND/OR USE OF NATIONAL PRODUCTS INCLUDING LIABILITY OR WARRANTIES RELATING TO FITNESS FOR A PARTICULAR PURPOSE, MERCHANTABILITY, OR INFRINGEMENT OF ANY PATENT, COPYRIGHT OR OTHER INTELLECTUAL PROPERTY RIGHT.

#### LIFE SUPPORT POLICY

**NATIONAL'S PRODUCTS ARE NOT AUTHORIZED FOR USE AS CRITICAL COMPONENTS IN LIFE SUPPORT DEVICES OR SYSTEMS WITHOUT THE EXPRESS PRIOR WRITTEN APPROVAL OF THE CHIEF EXECUTIVE OFFICER AND GENERAL COUNSEL OF NATIONAL SEMICONDUCTOR CORPORATION.** As used herein:

Life support devices or systems are devices which (a) are intended for surgical implant into the body, or (b) support or sustain life and whose failure to perform when properly used in accordance with instructions for use provided in the labeling can be reasonably expected to result in a significant injury to the user. A critical component is any component in a life support device or system whose failure to perform can be reasonably expected to cause the failure of the life support device or system or to affect its safety or effectiveness.

National Semiconductor and the National Semiconductor logo are registered trademarks of National Semiconductor Corporation. All other brand or product names may be trademarks or registered trademarks of their respective holders.

Copyright© 2010 National Semiconductor Corporation

For the most current product information visit us at [www.national.com](http://www.national.com)



**National Semiconductor Americas Technical Support Center**  
 Email: [support@nsc.com](mailto:support@nsc.com)  
 Tel: 1-800-272-9959

**National Semiconductor Europe Technical Support Center**  
 Email: [europe.support@nsc.com](mailto:europe.support@nsc.com)

**National Semiconductor Asia Pacific Technical Support Center**  
 Email: [ap.support@nsc.com](mailto:ap.support@nsc.com)

**National Semiconductor Japan Technical Support Center**  
 Email: [jpn.feedback@nsc.com](mailto:jpn.feedback@nsc.com)