

# DC-DC Converter Specification

## MPD5D01\*S

### 1. Application

This specification applies to DC-DC Converter MPD5D01\*S(\*:3 ~ 8) for telecommunication / data-communication equipment.

For any other application, please contact us before using this product.

### 2. Customer Reference

Customer Spec. Number  
Customer Part Number

### 3. Customer & Murata Part Number

| Nominal Output Voltage [V] | Customer Part Number | Part Number |
|----------------------------|----------------------|-------------|
| 1.5V                       |                      | MPD5D013S   |
| 1.8V                       |                      | MPD5D014S   |
| 2.5 V                      |                      | MPD5D016S   |
| 3.3V                       |                      | MPD5D017S   |
| 5.0V                       |                      | MPD5D018S   |

### 4. Appearance, Dimensions

Objective Products MPD5D01\*S (\* : 3 · 4 · 6 · 7 · 8)

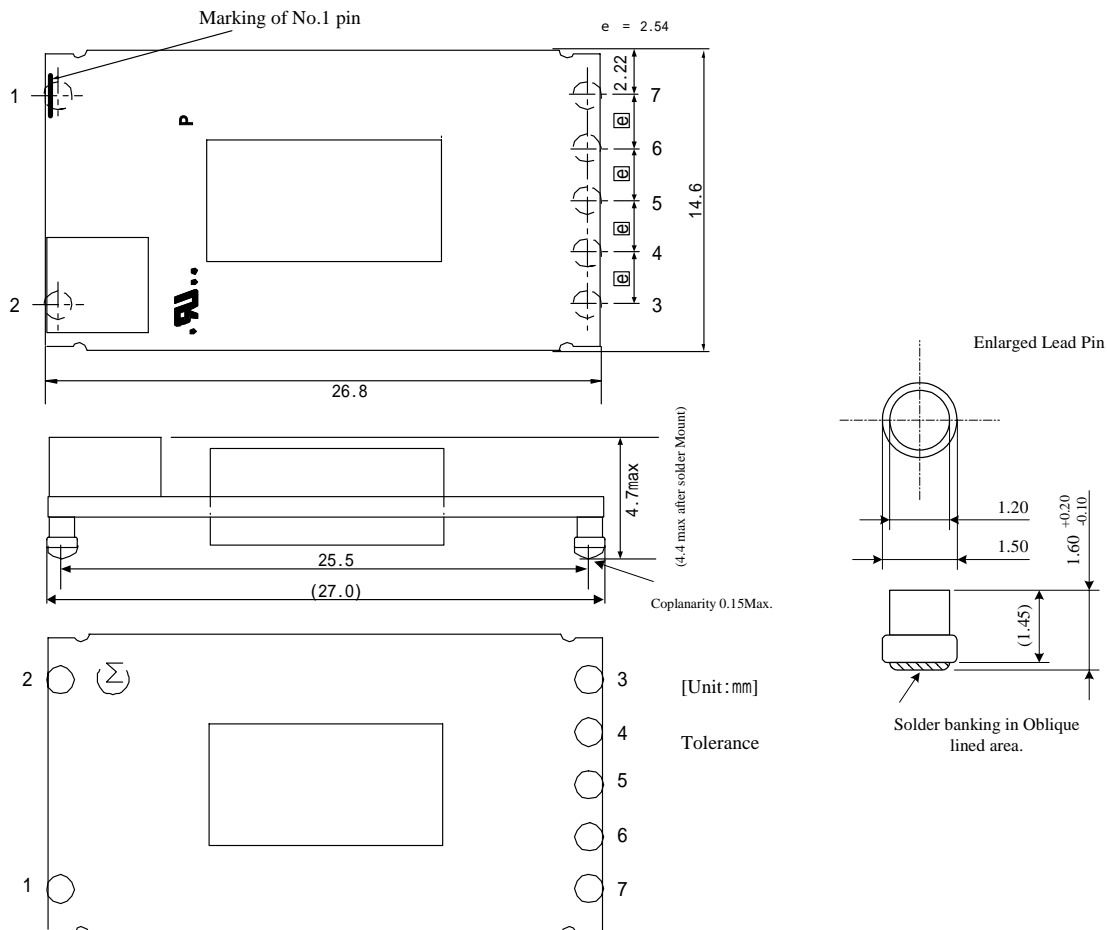

#### ⚠ Note:

- This datasheet is downloaded from the website of Murata Manufacturing co., ltd. Therefore, it's specifications are subject to change or our products in it may be discontinued without advance notice. Please check with our sales representatives or product engineers before ordering.
- This datasheet has only typical specifications because there is no space for detailed specifications. Therefore, please approve our product specifications or transact the approval sheet for product specifications before ordering.

Marking (1) Product Number Code P\*\* Refer to table 1  
 (2) MFG ID   
 (3) Lot No.  
 Production factory Mark  
 Production Year  
 Production Month ( 1,2,3,...9,O,N,D )  
 Product Modification Number (No Marking Now)  
 Last two letters of Product Number Code P\*\*

| Code  | Vout | Product Number |
|-------|------|----------------|
| P L P | 5.0V | MPD5D018S      |
| P L O | 3.3V | MPD5D017S      |
| P M U | 2.5V | MPD5D016S      |
| P M S | 1.8V | MPD5D014S      |
| P M R | 1.5V | MPD5D013S      |

### 5 . Pin Number and Function

| Pin No. | Symbol | Function                                 |
|---------|--------|--|
| 1       | +Vout  | (+)Output                                |
| 2       | -Vout  | (-)Output                                |
| 3       | ALM    | Alarm output to stop all in abnormality. |
| 4       | RC     | Remote ON/OFF                            |
| 5       | PO     | Parallel operation.                      |
| 6       | +Vin   | (+)Input                                 |
| 7       | -Vin   | (-)Input                                 |

### 6. Block Diagram

#### 6.1 Entire Product

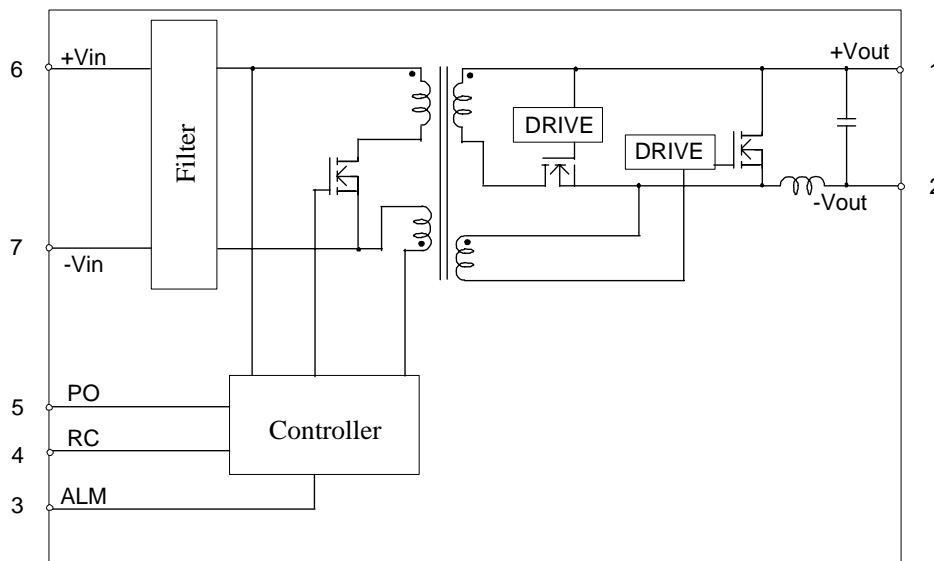

#### ⚠ Note:

1. This datasheet is downloaded from the website of Murata Manufacturing co., ltd. Therefore, it's specifications are subject to change or our products in it may be discontinued without advance notice. Please check with our sales representatives or product engineers before ordering.
2. This datasheet has only typical specifications because there is no space for detailed specifications. Therefore, please approve our product specifications or transact the approval sheet for product specifications before ordering.

## 7. Environmental Conditions

|                                 |  |
|---------------------------------|--|
| 7.1 Operating Temperature Range | -40°C ~ +85°C (Natural Air Convection : 0.2m/s with Vin=36 to 60V) |
| 7.2 Operating Humidity Range    | 20% ~ 85% ( No water condenses. )                                  |
| 7.3 Storage Temperature Range   | -45°C ~ +90°C  |
| 7.4 Storage Humidity Range      | 10% ~ 95%( No water condenses.)                                    |

## 8. Absolute Rating

| Item   |      |            | Unit | Absolute Rating | Remarks            |
|--|------|------------|------|-----------------|--------------------|
| Minimum Input Voltage  |      |            | V    | 0               |                    |
| Maximum Input Voltage<br>ALM Applied Voltage<br>RC Applied Voltage | Time | Continuous | V    | 75              |                    |
|  |      | 200μs      | V    | 90              | Slew rate 42V/10μs |
| PO Applied Voltage   |      |            | V    | 8               |                    |
| Maximum ALM Sink Current   |      |            | mA   | 10              |                    |

No voltage, no matter how instantaneous, shall be applied beyond the absolute maximum voltage rating to this product. If you apply any voltage over this limit the product characteristics will deteriorate or the product itself will be destroyed. Even though it may continue operating for a while after the over-voltage event, its life will likely be shortened significantly. Reliability and life of the module may degrade similarly if the maximum operating voltage rating is continuously exceeded. This product is designed to operate within the maximum operating voltage rating specification.

## 9. Characteristics

## 9.1 Electrical Characteristics (Ta=25°C)

## 9.1.1 General Characteristics

Unless otherwise specified, (Ta= -40 to +85°C with Natural Air Convection 0.2m/s)

| Item   | Symbol | Condition  | Value |      |      | Unit |
|--|--------|--|-------|------|------|------|
|  |        |  | Min.  | Typ. | Max. |      |
| Input Voltage Range                              | Vin    | Natural Air Convection Min 0.2m/s                              | 36    | 48   | 60   | V    |
|  |        | Forced Air Convection Min 0.5m/s                               | 60    | -    | 75   |      |
| Turn-on Input Voltage                            |        | Vin=increasing   | 32    | -    | 36   | V    |
| Input Voltage difference of Turn-on and Turn-off |        | PO pin : Open or Connected to PO pin of other DC-DC Converters | 2.0   | -    | -    | V    |
| Galvanic Isolation Voltage                       |        | Input time : 1 minute  | 1500  | -    | -    | Vdc  |

| Item                          | Standard   | Note                               |
|-------------------------------|--|------------------------------------|
| Noise (Radiation, Conduction) | In accordance with VCCI Class A                    |                                    |
| Safety Standard               | Recognized UL60950(UL/C-UL),<br>Complied IEC 60950 | UL file No.E190503                 |
|                               | CE Marking   | CE Mark is shown on a package box. |

## ⚠ Note:

- This datasheet is downloaded from the website of Murata Manufacturing co., ltd. Therefore, it's specifications are subject to change or our products in it may be discontinued without advance notice. Please check with our sales representatives or product engineers before ordering.
- This datasheet has only typical specifications because there is no space for detailed specifications. Therefore, please approve our product specifications or transact the approval sheet for product specifications before ordering.

## 9.1.2.1 Specific Characteristics

(Ta= -40 to +85°C with Natural Air Convection 0.2m/s ; Vin=36 to 60V or with Forced Air Convection 0.5m/s; Vin=60 to 75V)

| Part Number              |        | MPD5D013S  |       |      |      |      |
|--------------------------|--------|--|-------|------|------|------|
| Item                     | Symbol | Condition  | Value |      |      | Unit |
|                          |        |  | Min.  | Typ. | Max. |      |
| Nominal Output Voltage   | Vo     |  | -     | 1.5  | -    | V    |
| Output Voltage Variation | regtot | Vin=36 to 75V, Io=0 to 0.8A<br>Ta=-40 to +85°C   | -3    |      | +5   | %    |
| Output Current           | Io     | Natural Air Convection 0.2m/s(Vin=36 ~ 60V)<br>Forced Air Convection 0.5m/s(Vin=60 ~ 75V)  | 0     | -    | 0.8  | A    |
| Efficiency               |        | at rated Vin, Io, Ta=25°C  | -     | 70   | -    | %    |
| Ripple Voltage & Noise   | Vr     | Refer to Test Circuit  | -     | -    | 50   | mVpp |
| Over Current Protection  | Iocp   |  | 0.82  | -    | 1.68 | A    |
| Over Voltage Protection  | Vovp   | Output halts in latch-up mode after mask time 0.5msec (typ) to avoid malfunction by noise and transient change.<br>Input turn off and on to reset. | 1.8   | -    | 2.25 | V    |
| Low Voltage Protection   | Vlvp   | Output halts in latch-up mode after mask time 500msec (typ) to avoid malfunction by noise and transient change.<br>Input turn off and on to reset. | -     | -    | 1.35 | V    |

## 9.1.2.2 Specific Characteristics

(Ta= -40 to +85°C with Natural Air Convection 0.2m/s ; Vin=36 to 60V or with Forced Air Convection 0.5m/s; Vin=60 to 75V)

| Part Number              |        | MPD5D014S  |       |      |      |      |
|--------------------------|--------|--|-------|------|------|------|
| Item                     | Symbol | Condition  | Value |      |      | Unit |
|                          |        |  | Min.  | Typ. | Max. |      |
| Nominal Output Voltage   | Vo     |  | -     | 1.8  | -    | V    |
| Output Voltage Variation | regtot | Vin=36 to 75V, Io=0 to 1.0A<br>Ta=-40 to +85°C   | -3    |      | +5   | %    |
| Output Current           | Io     | Natural Air Convection 0.2m/s(Vin=36 ~ 60V)<br>Forced Air Convection 0.5m/s(Vin=60 ~ 75V)  | 0     | -    | 1.0  | A    |
| Efficiency               |        | at rated Vin, Io, Ta=25  | -     | 75   | -    | %    |
| Ripple Voltage & Noise   | Vr     | Refer to Test Circuit  | -     | -    | 50   | mVpp |
| Over Current Protection  | Iocp   |  | 1.03  | -    | 2.00 | A    |
| Over Voltage Protection  | Vovp   | Output halts in latch-up mode after mask time 0.5msec (typ) to avoid malfunction by noise and transient change.<br>Input turn off and on to reset. | 2.16  | -    | 2.70 | V    |
| Low Voltage Protection   | Vlvp   | Output halts in latch-up mode after mask time 500msec (typ) to avoid malfunction by noise and transient change.<br>Input turn off and on to reset. | -     | -    | 1.62 | V    |

## ⚠ Caution

The above electrical characteristics are guaranteed in the condition that the impedance of the input power supply is sufficiently low as shown in clause 10.

Connecting an input inductance or using an input power supply with output inductance may cause an unstable operation of this product. Please check the proper operation of this product with the peripheral circuits on your product.

## ⚠ Note:

1. This datasheet is downloaded from the website of Murata Manufacturing co., ltd. Therefore, it's specifications are subject to change or our products in it may be discontinued without advance notice. Please check with our sales representatives or product engineers before ordering.
2. This datasheet has only typical specifications because there is no space for detailed specifications. Therefore, please approve our product specifications or transact the approval sheet for product specifications before ordering.

## 9.1 .2. 3 Specific Characteristics

(Ta= -40 to +85°C with Natural Air Convection 0.2m/s ; Vin=36 to 60V or with Forced Air Convection 0.5m/s; Vin=60 to 75V)

| Part Number              |        | MPD5D016S  |       |      |      |      |
|--------------------------|--------|--|-------|------|------|------|
| Item                     | Symbol | Condition  | Value |      |      | Unit |
|                          |        |  | Min.  | Typ. | Max. |      |
| Nominal Output Voltage   | Vo     |  | -     | 2.5  | -    | V    |
| Output Voltage Variation | regtot | Vin=36 to 75V, Io=0 to 1.2A<br>Ta=-40 to +85°C   | -3    |      | +5   | %    |
| Output Current           | Io     | Natural Air Convection 0.2m/s(Vin=36 ~ 60V)<br>Forced Air Convection 0.5m/s(Vin=60 ~ 75V)  | 0     | -    | 1.2  | A    |
| Efficiency               |        | at rated Vin, Io, Ta=25°C  | -     | 80   | -    | %    |
| Ripple Voltage & Noise   | Vr     | Refer to Test Circuit  | -     | -    | 50   | mVpp |
| Over Current Protection  | Iocp   |  | 1.23  | -    | 2.34 | A    |
| Over Voltage Protection  | Vovp   | Output halts in latch-up mode after mask time 0.5msec (typ) to avoid malfunction by noise and transient change.<br>Input turn off and on to reset. | 3.0   | -    | 3.75 | V    |
| Low Voltage Protection   | Vlvp   | Output halts in latch-up mode after mask time 500msec (typ) to avoid malfunction by noise and transient change.<br>Input turn off and on to reset. | -     | -    | 2.25 | V    |

## 9.1 .2. 4 Specific Characteristics

(Ta= -40 to +85°C with Natural Air Convection 0.2m/s ; Vin=36 to 60V or with Forced Air Convection 0.5m/s; Vin=60 to 75V)

| Part Number              |        | MPD7D108S  |       |      |      |      |
|--------------------------|--------|--|-------|------|------|------|
| Item                     | Symbol | Condition  | Value |      |      | Unit |
|                          |        |  | Min.  | Typ. | Max. |      |
| Nominal Output Voltage   | Vo     |  | -     | 3.3  | -    | V    |
| Output Voltage Variation | regtot | Vin=36 to 75V, Io=0 to 1.5A<br>Ta=-40 to +85°C   | -3    |      | +5   | %    |
| Output Current           | Io     | Natural Air Convection 0.2m/s(Vin=36 ~ 60V)<br>Forced Air Convection 0.5m/s(Vin=60 ~ 75V)  | 0     | -    | 1.5  | A    |
| Efficiency               |        | at rated Vin, Io, Ta=25°C  | -     | 84   | -    | %    |
| Ripple Voltage & Noise   | Vr     | Refer to Test Circuit  | -     | -    | 50   | mVpp |
| Over Current Protection  | Iocp   |  | 1.54  | -    | 2.65 | A    |
| Over Voltage Protection  | Vovp   | Output halts in latch-up mode after mask time 0.5msec (typ) to avoid malfunction by noise and transient change.<br>Input turn off and on to reset. | 3.96  | -    | 4.62 | V    |
| Low Voltage Protection   | Vlvp   | Output halts in latch-up mode after mask time 500msec (typ) to avoid malfunction by noise and transient change.<br>Input turn off and on to reset. | -     | -    | 2.97 | V    |

**Caution**

The above electrical characteristics are guaranteed in the condition that the impedance of the input power supply is sufficiently low as shown in clause 10.

Connecting an input inductance or using an input power supply with output inductance may cause an unstable operation of this product. Please check the proper operation of this product with the peripheral circuits on your product.

**Note:**

1. This datasheet is downloaded from the website of Murata Manufacturing co., ltd. Therefore, it's specifications are subject to change or our products in it may be discontinued without advance notice. Please check with our sales representatives or product engineers before ordering.
2. This datasheet has only typical specifications because there is no space for detailed specifications. Therefore, please approve our product specifications or transact the approval sheet for product specifications before ordering.

## 9.1.2.5 Specific Characteristics

(Ta= -40 to +85°C with Natural Air Convection 0.2m/s ; Vin=36 to 60V or with Forced Air Convection 0.5m/s; Vin=60 to 75V)

| Part Number              |        | MPD7D108S  |       |      |      |      |
|--------------------------|--------|--|-------|------|------|------|
| Item                     | Symbol | Condition  | Value |      |      | Unit |
|                          |        |  | Min.  | Typ. | Max. |      |
| Nominal Output Voltage   | Vo     |  | -     | 5.0  | -    | V    |
| Output Voltage Variation | regtot | Vin=36 to 75V, Io=0 to 1.0A<br>Ta=-40 to +85°C   | -3    |      | +5   | %    |
| Output Current           | Io     | Natural Air Convection 0.2m/s(Vin=36 ~ 60V)<br>Forced Air Convection 0.5m/s(Vin=60 ~ 75V)  | 0     | -    | 1.0  | A    |
| Efficiency               |        | at rated Vin, Io, Ta=25°C  | -     | 85   | -    | %    |
| Ripple Voltage & Noise   | Vr     | Refer to Test Circuit  | -     | -    | 50   | mVpp |
| Over Current Protection  | Iocp   |  | 1.03  | -    | 1.70 | A    |
| Over Voltage Protection  | Vovp   | Output halts in latch-up mode after mask time 0.5msec (typ) to avoid malfunction by noise and transient change.<br>Input turn off and on to reset. | 6.0   | -    | 7.0  | V    |
| Low Voltage Protection   | Vlvp   | Output halts in latch-up mode after mask time 500msec (typ) to avoid malfunction by noise and transient change.<br>Input turn off and on to reset. | -     | -    | 4.5  | V    |

**Caution**

The above electrical characteristics are guaranteed in the condition that the impedance of the input power supply is sufficiently low as shown in clause 10.

Connecting an input inductance or using an input power supply with output inductance may cause an unstable operation of this product. Please check the proper operation of this product with the peripheral circuits on your product.

## 9.2 Operation information

## 9.2.1 Reset Condition

In order to reset all function, the input Voltage is set under 5V for Min.1 second.

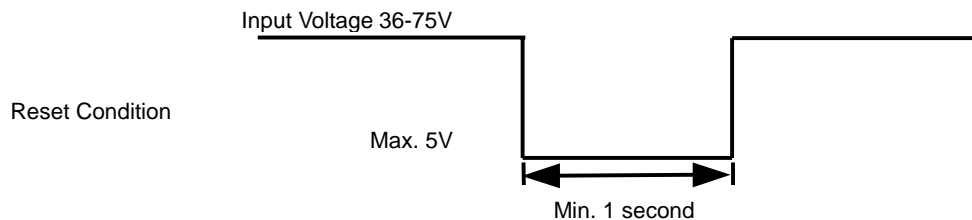

## 9.2.2 Over Voltage Protection

Output halts in latch-up mode after 0.5msec(typ) mask time while Output Voltage is over the value of over voltage protection specified in 9.1. clause with failure of controller circuit.

Output will re-start after input turns off for Min. 1 second with input voltage less than 5V.

Output voltage might exceed the point at over voltage protection under the specific condition of transient change of input voltage or output load, in this condition over voltage protection wait its start until the mask time.

It is recommended to evaluate your appliance installed with DC-DC converter.

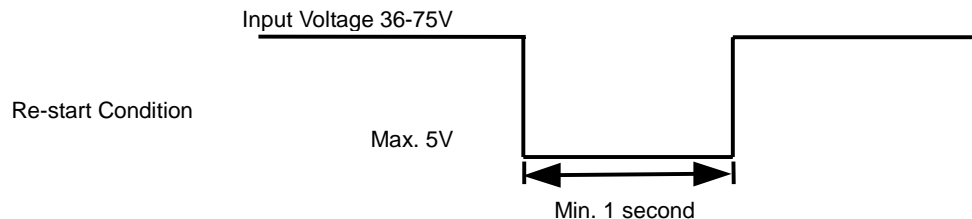
**Note:**

1. This datasheet is downloaded from the website of Murata Manufacturing co., ltd. Therefore, it's specifications are subject to change or our products in it may be discontinued without advance notice. Please check with our sales representatives or product engineers before ordering.
2. This datasheet has only typical specifications because there is no space for detailed specifications. Therefore, please approve our product specifications or transact the approval sheet for product specifications before ordering.

### 9. 2. 3 Low Voltage Protection

Output halts in latch-up mode after 500msec(typ) mask time while output voltage is below the value of low voltage protection specified in 9.1.clause with failure of controller circuit or over load condition. Output will re-start after input turns off for Min.1 second with input voltage less than 5V.

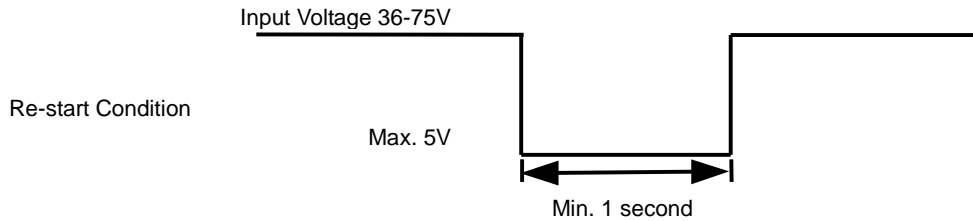

### 9. 2. 4 Remote On/Off Control

Start and halt is possible with a control signal.  
While the control signal stops output from DC-DC Converter, alarm output does not send any signal.  
Start : RC is open or connected to -Vin.  
Halt : RC is connected to +Vin.

### 9. 2. 5 Alarm Output

ALM pin is down to the same voltage level of -Vin pin and sends an alarm signal. (open-drain output)  
Sink current in ALM pin is Max.20mA.  
It is possible to halt all of the connected DC-DC Converters when any one is halted with over voltage protection or low voltage protection, with connecting all ALM pins for the application of multiple operation with plural DC-DC converters.  
The maximum number connecting DC-DC Converters is (one this product is counted as two) 20pcs for the purpose of halting all DC-DC Converters connected with ALM pin each other. When the other series are connected to this series for multiple operation, please count one this product as two. Also please contact us when more than 20pcs.

### 9. 2. 6 Synchronous Turn-on/off

ALM pin is down to the same voltage level of -Vin pin and sends an alarm signal. (open-drain output)  
Sink current in ALM pin is Max.10mA.  
It is possible to halt all of the connected DC-DC Converters when any one is halted with over voltage protection or low voltage protection, with connecting all ALM pins for the application of parallel/multiple operation with plural DC-DC Converters.  
The maximum number connecting DC-DC Converters is 10pcs for the purpose of halting all DC-DC Converters connected with ALM pin each other.  
Please contact us when more than 10pcs.

## 9. 3 Reliability

### 9. 3. 1 Reliability Test Items

| Item                 | Test Condition  | Criteria   |
|----------------------|---|--|
| Humidity             | +40 ± 2°C 90 to 95%RH 100 hours<br>Then RT(25°C) for 4 hours (JIS-C-0022) | No damage in appearance and no deviation of elect before and after the test. |
| Temp. Cycle          | --40 ± 3°C (30minutes)  |  |
|                      | Room temp.(5 to 10 minutes)   |  |
|                      | +85 ± 3°C (30minutes)   |  |
|                      | Room temp.(5 to 10 minutes)   |  |
|                      | Repeat 5time of the above   |  |
| Mechanical Vibration | 10 to 55Hz, max. 1.5mm amplitude, 1 hour for each of X, Y, Z directions.  |  |
| Mechanical Shock     | 20G, 1 time for each of X, Y, Z directions.                               |  |

#### △ Note:

1. This datasheet is downloaded from the website of Murata Manufacturing co., ltd. Therefore, it's specifications are subject to change or our products in it may be discontinued without advance notice. Please check with our sales representatives or product engineers before ordering.
2. This datasheet has only typical specifications because there is no space for detailed specifications. Therefore, please approve our product specifications or transact the approval sheet for product specifications before ordering.

### 9. 3. 2 Soldering Heat Resistance

Immerse the part of lead where it is to be soldered on a motherboard in a solder bath of 260+/-5°C for 3+/-0.5s.

Then tested products are left for 2 hours.

There is no damage in appearance and no deviation from electrical characteristics in clause 9.

### 9. 3. 3 Lead Pin Strength

Strain a lead pin by gradual-increasingly 5.0N along axial direction; withstand for 5s.

No damage on a lead pin.

### 9. 3. 4 Solderability of Leads

The lead pins will be immersed in the Isopropyl Alcohol (JIS K 1522) with Rosin (JIS K5902) solution (the concentration of Rosin will be allowed 10wt% to 35wt%, and normally approx. 25wt% will be used without any specific requirement.).

Then the lead pins will be immersed in the solder H63A (JIS Z 3282) solution at the temperature of 230°C +/-5°C for 3+/-0.5seconds, and pulled up completely.

The solder will adhere to over 75% of immersed area.

## 10. Test Circuit

In the following test circuit, the measured values should meet those of clause 9.

### 10.1 General Measure Circuit

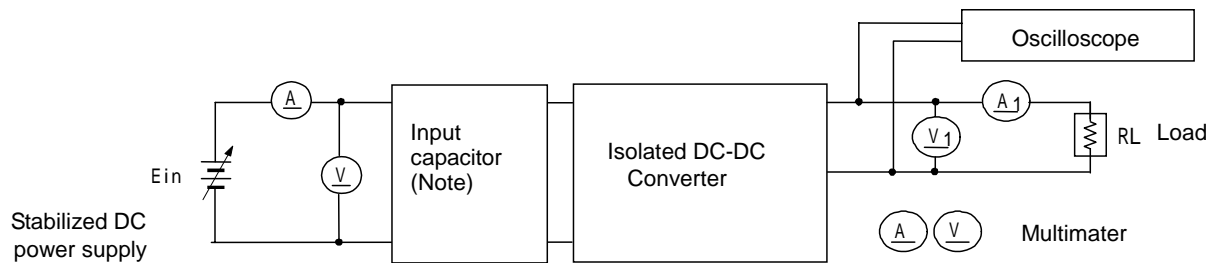

(Note) Please connect 10 $\mu$ F input capacitor for the test condition considered input voltage chattering.

### 10.1.1 Output Ripple & Noise

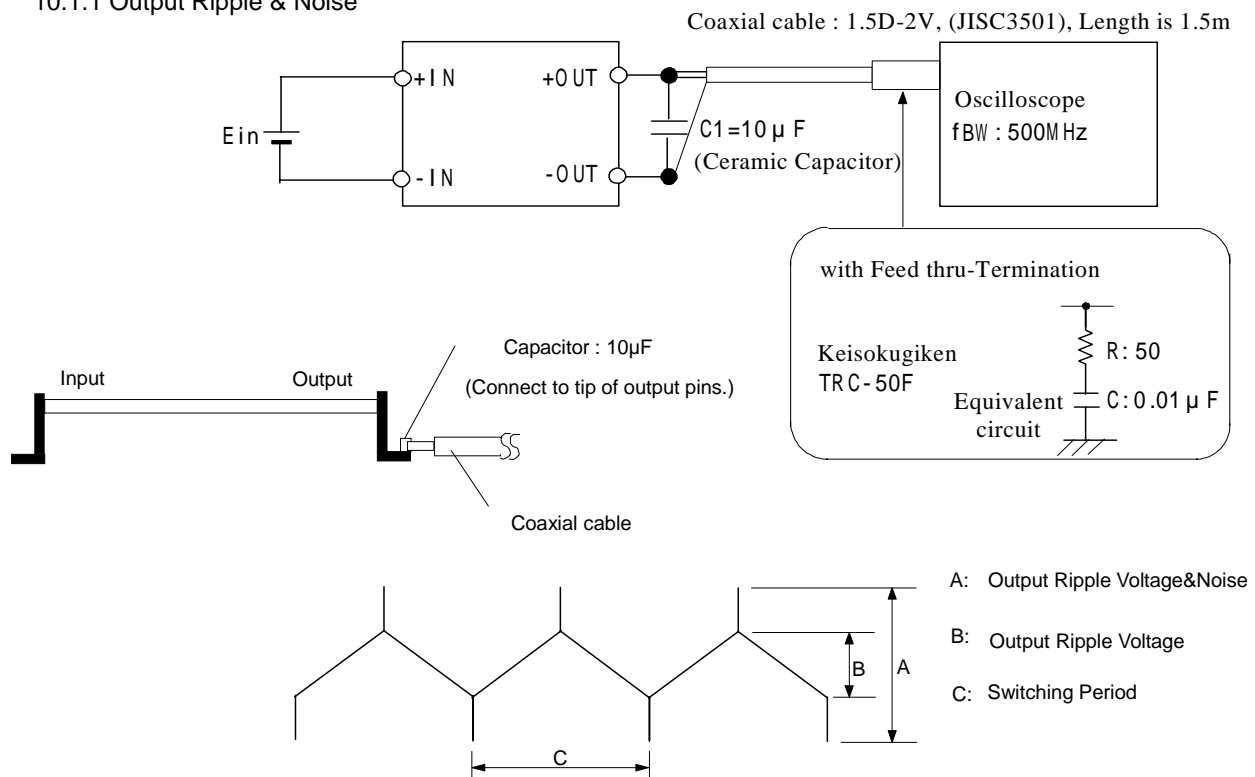

#### ⚠ Note:

1. This datasheet is downloaded from the website of Murata Manufacturing co., ltd. Therefore, it's specifications are subject to change or our products in it may be discontinued without advance notice. Please check with our sales representatives or product engineers before ordering.
2. This datasheet has only typical specifications because there is no space for detailed specifications. Therefore, please approve our product specifications or transact the approval sheet for product specifications before ordering.



## 11. Packaging Information

## 11.1 Tray Dimensions

DC-DC Converters are put in the trays. (See Fig.1)

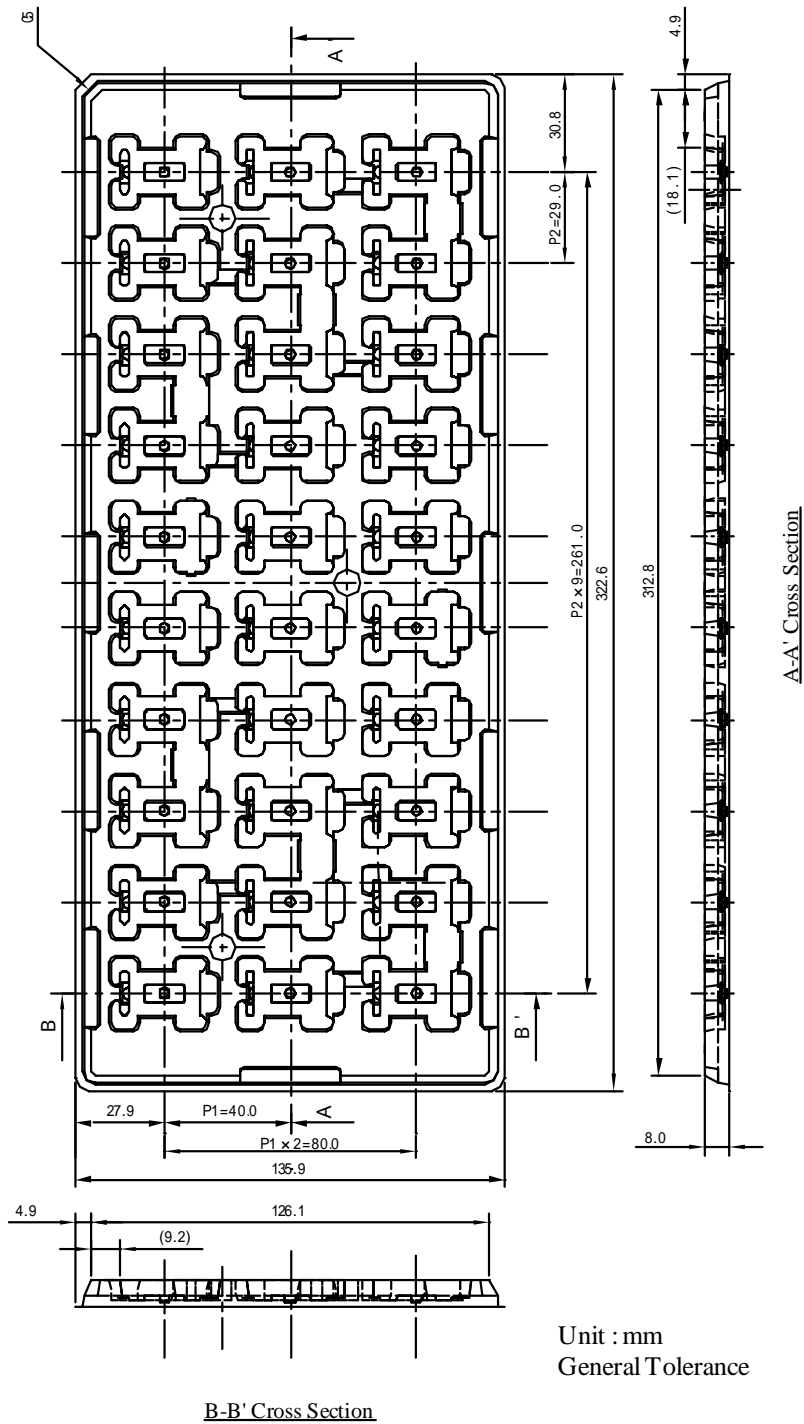

Fig.1

## △ Note:

1. This datasheet is downloaded from the website of Murata Manufacturing co., ltd. Therefore, it's specifications are subject to change or our products in it may be discontinued without advance notice. Please check with our sales representatives or product engineers before ordering.
2. This datasheet has only typical specifications because there is no space for detailed specifications. Therefore, please approve our product specifications or transact the approval sheet for product specifications before ordering.

### 11.2 Contained pieces of products per corrugated box.

Maximum Contained products pieces 210 pcs/corrugated box.

Further plural sheets of corrugated cardboard are placed on the top of the dummy tray according to number of contained trays in order to full up the space in a corrugated box.

### 11.3 Packaging Form

Trays with products are lidded and packed in a corrugated box. (See Fig.2)

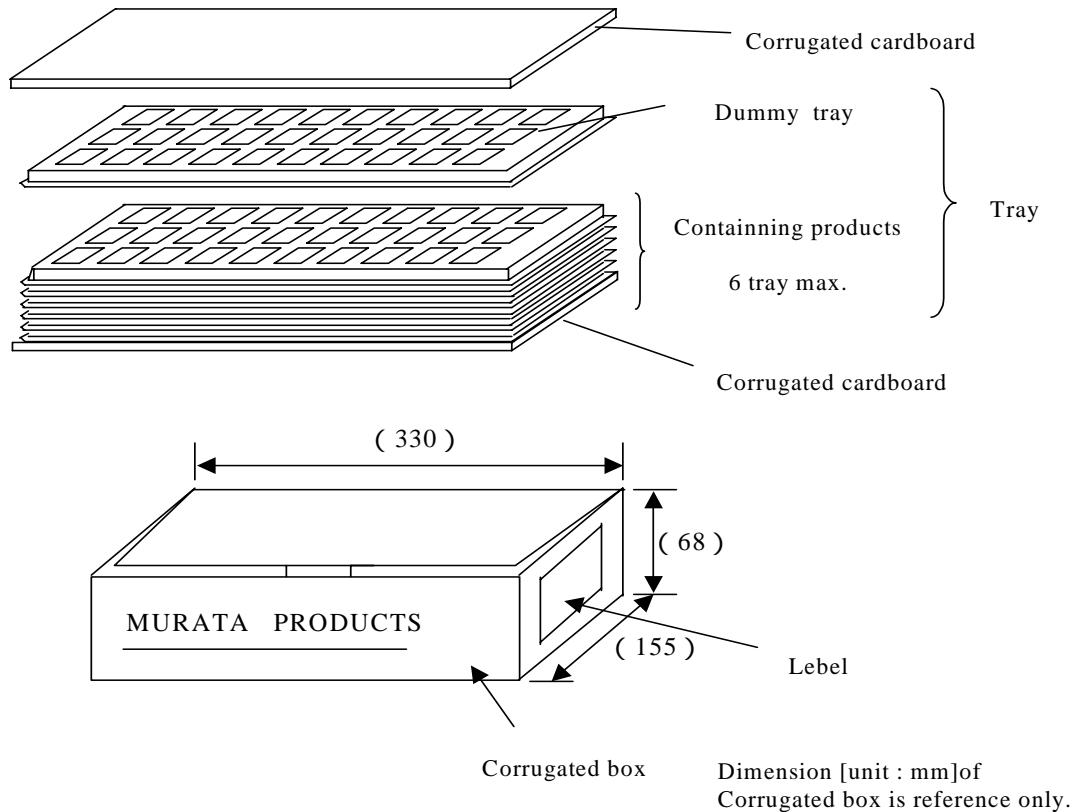

Fig.2

### Marking on the box

1. MURATA Parts Number
2. Quantity
3. Inspection No.
4. CE Mark

### 12. Production factory

Wakura Murata Mfg. Co., Ltd.  
Kanazu Murata Mfg.Co.,Ltd.  
Komatsu Murata Mfg.Co.,Ltd.

#### ⚠ Note

1. Be sure to provide an appropriate fail-safe function on your product to prevent secondary damage that may be caused by the functional trouble or the failure of this product.
2. Please contact us before using this product for the applications listed below which require especially high reliability for the prevention of defects and failure, which might directly cause damage to the third party's life, body or property.

Aircraft equipment  
Aerospace equipment  
Undersea equipment  
Power plant control equipment  
Medical equipment  
Transportation equipment (vehicles, trains, ships, etc.)  
Traffic signal equipment  
Disaster prevention /crime prevention equipment  
Any other application of similar complexity and/or reliability requirements to the applications listed above.

#### ⚠ Note:

1. This datasheet is downloaded from the website of Murata Manufacturing co., ltd. Therefore, it's specifications are subject to change or our products in it may be discontinued without advance notice. Please check with our sales representatives or product engineers before ordering.
2. This datasheet has only typical specifications because there is no space for detailed specifications. Therefore, please approve our product specifications or transact the approval sheet for product specifications before ordering.

### 13 . Notice

#### 13. 1 Soldering

##### 13. 1. 1 Flux

Please solder this product with Rosin Flux, which contains of 0.2wt%. or less chlorine.  
Please do not use high activity acid flux or water soluble flux because they may erode metal or glass portion of this product and may cause defectiveness or deterioration of this product.

##### 13. 1. 2 Solder

Please use the solder H60, H63(JIS Z3282)or the equivalent type.  
Please use the solder paste of equivalent type H60, H63.

##### 13. 1. 3 Recommended Soldering Conditions Reflow Solder

###### Reflow Soldering Profiles

JEDEC IPC/JEDEC J-STD-020D

Table 5-2 Classification Reflow Profiles

Pb-Free Assembly Large Body

###### Profile details

|                       |                                     |
|-----------------------|-------------------------------------|
| Soldering temperature | : 245 °C +0/-5                      |
| Soldering time        | : 30 seconds, 240 ~ 245 °C          |
| Heating time          | : 60 ~ 150 seconds, 217 °C or more. |
| Preheating time       | : 60 ~ 120seconds, 150 ~ 200 °C     |
| Programming rate      | : 3 °C /sec. Max., 217 ~ 245 °C     |
| Descending rate       | : 6 °C /sec. Max.                   |
| Total soldering time  | : 8 minutes Max., 25 ~ 245 °C       |
| Time                  | : Maximum 2times                    |

The solder used to this product is melted in reflow process.

Therefore do not add excessive vibration and strong air below to this product during reflow.

Please take out the products from a reflow furnace after the product temperature is cooled down thoroughly.

When this product is mounted on backside of a motherboard like the below figure, the measurement except soldering should be taken with dipping thermal setting resin around a Transformer Metal Cover to prevent this product from dropping.

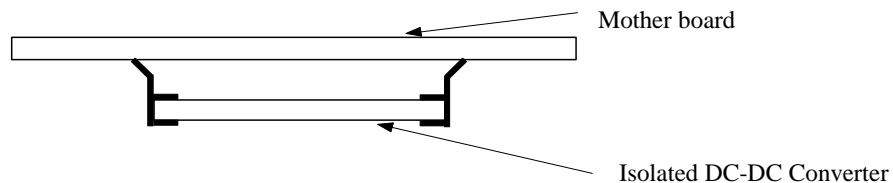

[Note] The product has a solder banking on the top of a lead pin.

Coplanarity is required with melting the solder banking during reflow process.

Therefore please confirm in advance that the solder banking is melted enough.

#### 13. 2 Cleaning

13. 2. 1 Please clean this product to remove flux by using dip, boil, and vapor methods in isopropyl alcohol for up to 5 minutes.

Please inform us if you are to use aqueous or semi -aqueous cleaning or other methods.

Do not use ultrasonic cleaning because semiconductor device on this product maybe damaged by resonance.

13. 2. 2 After cleaning, please dry this product thoroughly.

If you touch the wet product, marking maybe erased or blurred.

Do not measure electrical characteristics, until this product gets dried enough.

13. 2. 3 If you don't clean this product with no-cleaning type flux, you must confirm fully in advance the reliability of this product.

#### ⚠ Note:

1. This datasheet is downloaded from the website of Murata Manufacturing co., ltd. Therefore, it's specifications are subject to change or our products in it may be discontinued without advance notice. Please check with our sales representatives or product engineers before ordering.
2. This datasheet has only typical specifications because there is no space for detailed specifications. Therefore, please approve our product specifications or transact the approval sheet for product specifications before ordering.

### 13. 3 Storage

13. 3. 1 Please store the products in room where the temperature/humidity is stable and direct sunlight cannot come in, and use the products within 6 months after delivery.  
Please avoid damp and heat or such places where the temperature greatly changes, as water may condense on this product, and the quality of characteristics may be reduced, and/or be the solderability may be degraded.  
If this product needs to be stored for a long time (more than 1 year), this product may be degraded in solderability and/or corroded. Please test the solderability of this product regularly.
13. 3. 2 Please do not store this product in the conditions such as a dusty place, a place exposed directly to sea breeze, or in an atmosphere containing corrosive gas (Cl<sub>2</sub>, NH<sub>3</sub>, SO<sub>2</sub>, NO<sub>X</sub> and so on).

### 13. 4 Operational Environment and Operational Conditions

#### 13. 4. 1 Operational Environment

This product is not water-, chemical- or corrosion-proof.

In order to prevent leakage of electricity and abnormal temperature rise of this product, do not use this product in the following conditions:

- (1) in an atmosphere containing corrosive gas (Cl<sub>2</sub>, NH<sub>3</sub>, SO<sub>2</sub>, NO<sub>X</sub> and so on)
- (2) in a dusty place
- (3) in a place exposed to direct sunlight
- (4) in such a place where water splashes or in such a humid place where water condenses
- (5) in a place exposed to sea breeze
- (6) in any other places similar to the above

#### 13. 4. 2 Operational Conditions

Please use this product within specified values (power supply, temperature, input, output, load condition, and so on).

If not used within the specified values, defectiveness and deterioration of this product may be caused.

Even if this product can endure the condition for short time, it may cause degradation of reliability.

It is recommended that a fuse is inserted in input line (V<sub>in</sub>) to secure safety in any abnormality such as internal circuit of Isolated DC-DC Converter broken down.

Also please take care that the external voltage over output voltage of DC-DC Converter does not applies to output of this Isolated DC-DC Converter.

#### 13. 4. 3 Note prior to use

Defectiveness and reliability degradation may be caused if high static electricity, over rated voltage or reverse voltage are applied to this product. Please be sure to avoid the followings:

- (1) over rating power supply, reverse power supply or inadequate connection of 0 V(DC)line
- (2) electrostatic discharge from production line and/or operator
- (3) electrified product from electrostatic induction

Please avoid an excessive mechanical shock.

If this product is dropped on the floor, etc., a crack to the core of inductors and monolithic ceramic capacitors may occur.

Please handle with care to avoid a strong shock to this product.

Do not give excessive mechanical stress to the product with your handling.

Please control to bend in a maximum of 0.2mm in your application.

### 13. 5 Transportation

When transporting this product, please pack it in order to avoid damage by mechanical vibration or mechanical shock, and please give instructions and set guidelines to the carriers to prevent rough handling.

When transporting this product overseas (in particular, by sea), bad environment of transportation may be expected, therefore please pack this product considering mechanical strength, vibration-resistance and humidity-resistance.

The packaging designed for domestic sales may not suitable for overseas transportation.

Please contact us if this product with domestic packing is transported overseas.

### 14. Note

1. Murata recommends that customers ensure that the evaluation and testing of these devices are completed with this product actually assembled on their product.
2. All the items and parameters in this product specification have been prescribed on the premise that Murata's product is used for the purpose, under the condition and in the environment mutually agreed upon.

**This document is for reference only and subject to revision without prior of subsequent notice.  
Please contact Murata for latest documentation.**

#### Note:

1. This datasheet is downloaded from the website of Murata Manufacturing co., ltd. Therefore, it's specifications are subject to change or our products in it may be discontinued without advance notice. Please check with our sales representatives or product engineers before ordering.
2. This datasheet has only typical specifications because there is no space for detailed specifications. Therefore, please approve our product specifications or transact the approval sheet for product specifications before ordering.