

FEATURES

- Variable analog input bandwidth control
- Variable SOGIN bandwidth control
- Automated clamping level adjustment
- 140 MSPS maximum conversion rate
- 300 MHz analog bandwidth
- 0.5 V to 1.0 V analog input range
- 500 ps p-p PLL clock jitter at 110 MSPS
- 3.3 V power supply
- Full sync processing
- Selectable input filtering
- Sync detect for hot plugging
- Midscale clamping
- Power-down mode
- Low power: 500 mW typical
- 4:2:2 output format mode

APPLICATIONS

- RGB graphics processing
- LCD monitors and projectors
- Plasma display panels
- Scan converters
- Microdisplays
- Digital TVs

GENERAL DESCRIPTION

The AD9985A is a complete 8-bit, 140 MSPS, monolithic analog interface optimized for capturing RGB graphics signals from personal computers and workstations. Its 140 MSPS encode rate capability and full power analog bandwidth of 300 MHz support resolutions up to SXGA (1280 × 1024 at 75 Hz).

The AD9985A includes a 140 MHz triple ADC with internal 1.25 V reference, a PLL, and programmable gain, offset, and clamp control. The user provides only a 3.3 V power supply, analog input, and horizontal sync (Hsync) and Coast signals. Three-state CMOS outputs can be powered from 2.5 V to 3.3 V.

The AD9985A's on-chip PLL generates a pixel clock from the Hsync input. Pixel clock output frequencies range from 12 MHz to 140 MHz. PLL clock jitter is 500 ps p-p typical at 140 MSPS.

Rev. 0

Information furnished by Analog Devices is believed to be accurate and reliable. However, no responsibility is assumed by Analog Devices for its use, nor for any infringements of patents or other rights of third parties that may result from its use. Specifications subject to change without notice. No license is granted by implication or otherwise under any patent or patent rights of Analog Devices. Trademarks and registered trademarks are the property of their respective owners.

FUNCTIONAL BLOCK DIAGRAM

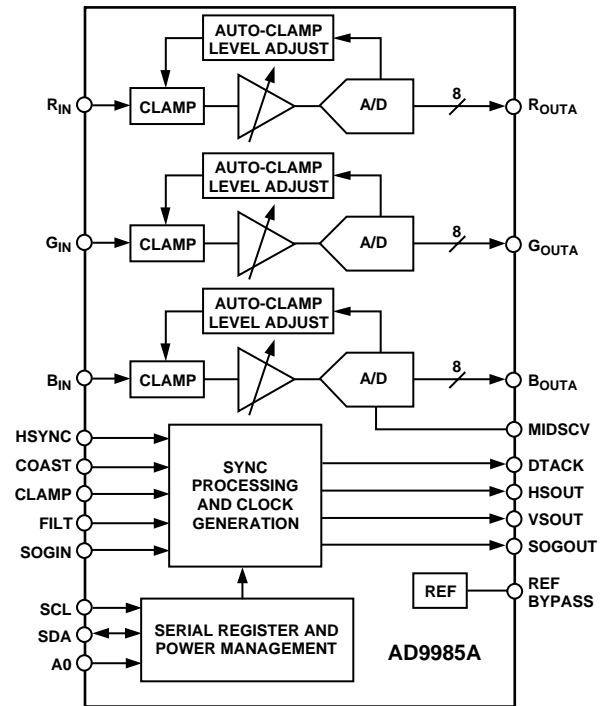

Figure 1.

When the Coast signal is presented, the PLL maintains its output frequency in the absence of Hsync. A sampling phase adjustment is provided. Data, Hsync, and clock output phase relationships are maintained. The AD9985A also offers full sync processing for composite sync and sync-on-green applications.

A clamp signal is generated internally or can be provided by the user through the CLAMP input pin. This interface is fully programmable via a 2-wire serial interface.

Fabricated in an advanced CMOS process, the AD9985A is provided in a space-saving 80-lead LQFP surface-mount Pb-free plastic package, and is specified over the -40°C to +85°C temperature range.

TABLE OF CONTENTS

Specifications.....	3	Hsync Timing	15
Explanation of Test Levels.....	6	Coast Timing	16
Absolute Maximum Ratings.....	7	2-Wire Serial Register Map	17
ESD Caution.....	7	2-Wire Serial Control Register Detail Chip Identification ...	19
Pin Configuration and Function Descriptions.....	8	PLL Divider Control	19
Design Guide.....	11	Clock Generator Control	20
General Description	11	Clamp Timing.....	20
Digital Inputs	11	Hsync Pulse Width.....	20
Input Signal Handling.....	11	Input Gain	20
Hsync, Vsync Inputs	11	Input Offset	21
Serial Control Port	11	Mode Control 1	21
Output Signal Handling.....	11	2-Wire Serial Control Port	26
Clamping	11	Data Transfer via Serial Interface.....	26
RGB Clamping.....	11	Sync Slicer.....	28
YUV Clamping.....	12	Sync Separator	28
Gain and Offset Control.....	12	PCB Layout Recommendations.....	29
Auto Offset	12	Analog Interface Inputs.....	29
Sync-on-Green.....	13	Power Supply Bypassing.....	29
Clock Generation	13	PLL	29
12-Bit Divisor Register	14	Outputs (Both Data and Clocks).....	30
2-Bit VCO Range Register	14	Digital Inputs	30
3-Bit Charge Pump Current Register	14	Voltage Reference	30
5-Bit Phase Adjust Register.....	14	Outline Dimensions	31
Power Management.....	14	Ordering Guide	31
Timing.....	15		

REVISION HISTORY**7/05—Revision 0: Initial Version**

SPECIFICATIONS

$V_D = 3.3\text{ V}$, $V_{DD} = 3.3\text{ V}$, ADC clock = maximum conversion rate, unless otherwise noted.

Table 1.

Parameter	Temp	Test Level	AD9985AKSTZ-110			AD9985AKSTZ-140			Unit
			Min	Typ	Max	Min	Typ	Max	
RESOLUTION			8			8			Bits
DC ACCURACY									
Differential Nonlinearity	25°C	I		±0.5	+1.25/−1.0		±0.5	+1.35/−1.0	LSB
	Full	VI			+1.35/−1.0			±1.45/−1.0	LSB
Integral Nonlinearity	25°C	I		±0.5	±1.85		±0.5	±2.0	LSB
	Full	VI			±2.0			±2.3	LSB
No Missing Codes	Full	VI		Guaranteed				Guaranteed	
ANALOG INPUT									
Input Voltage Range									
Minimum	Full	VI			0.5			0.5	V p-p
Maximum	Full	VI	1.0			1.0			V p-p
Gain Tempco	25°C	V		100			100		ppm/°C
Input Bias Current	25°C	IV			1			1	μA
	Full	IV			1			1	μA
Input Offset Voltage	Full	V		7			7		mV
Input Full-Scale Matching	Full	VI		1.5	8.0		1.5	8.0	%FS
Offset Adjustment Range	Full	VI	46	49	52	46	49	52	%FS
REFERENCE OUTPUT									
Output Voltage	Full	V		1.25			1.25		V
Temperature Coefficient	Full	V		±50			±50		ppm/°C
SWITCHING PERFORMANCE									
Maximum Conversion Rate	Full	VI	110			140			MSPS
Minimum Conversion Rate	Full	IV			10			10	MSPS
Data to Clock Skew	Full	IV	−0.5		+2.0	−0.5		+2.0	ns
t_{BUFF}	Full	VI	4.7			4.7			μs
t_{STAH}	Full	VI	4.0			4.0			μs
t_{DHO}	Full	VI	300			300			ns
t_{DAL}	Full	VI	4.7			4.7			μs
t_{DAH}	Full	VI	4.0			4.0			μs
t_{DSU}	Full	VI	250			250			ns
t_{STASU}	Full	VI	4.7			4.7			μs
t_{STOTSU}	Full	VI	4.0			4.0			μs
HSYNC Input Frequency	Full	IV	15		110	15		110	kHz
Maximum PLL Clock Rate	Full	VI	110			140			MHz
Minimum PLL Clock Rate	Full	IV			12			12	MHz
PLL Jitter	25°C	IV		400	700 ¹		400	700 ¹	ps p-p
	Full	IV			1000 ¹		400	700 ¹	ps p-p
Sampling Phase Tempco	Full	IV		15			15		ps/°C
DIGITAL INPUTS									
Input Voltage, High (V_{IH})	Full	VI	2.5			2.5			V
Input Voltage, Low (V_{IL})	Full	VI			0.8			0.8	V
Input Current, High (I_{IH})	Full	V			−1.0			−1.0	μA
Input Current, Low (I_{IL})	Full	V			+1.0			+1.0	μA
Input Capacitance	25°C	V		3			3		pF

AD9985A

Parameter	Temp	Test Level	AD9985AKSTZ-110			AD9985AKSTZ-140			Unit
			Min	Typ	Max	Min	Typ	Max	
DIGITAL OUTPUTS									
Output Voltage, High (V_{OH})	Full	VI	$V_D - 0.1$			$V_D - 0.1$			V
Output Voltage, Low (V_{OL})	Full	VI			0.1			0.1	V
Duty Cycle DATAACK	Full	IV	45	50	55	45	50	55	%
Output Coding				Binary			Binary		
POWER SUPPLY									
V_D Supply Voltage	Full	IV	3.15	3.3	3.45	3.15	3.3	3.45	V
V_{DD} Supply Voltage	Full	IV	2.2	3.3	3.45	2.2	3.3	3.45	V
P_{VD} Supply Voltage	Full	IV	3.15	3.3	3.45	3.15	3.3	3.45	V
I_D Supply Current (V_D)	25°C	V		132			180		mA
I_{DD} Supply Current (V_{DD}) ²	25°C	V		19			26		mA
I_{PVD} Supply Current (P_{VD})	25°C	V		8			11		mA
Total Power Dissipation	Full	VI		525	760		650	900	mW
Power-Down Supply Current	Full	VI		5	15		5	15	mA
Power-Down Dissipation	Full	VI		16.5	50		16.5	50	mW
DYNAMIC PERFORMANCE									
Analog Bandwidth, Full Power	25°C	V		300			300		MHz
Transient Response	25°C	V		2			2		ns
Overshoot Recovery Time	25°C	V		1.5			1.5		ns
Signal-to-Noise Ratio (SNR)	25°C	V		44			43		dB
(Without Harmonics)	Full	V		43			42		dB
$f_{IN} = 40.7$ MHz									
Crosstalk	Full	V		55			55		dBc
THERMAL CHARACTERISTICS									
θ_{JC} Junction-to-Case Thermal Resistance		V		16			16		°C/W
θ_{JA} Junction-to-Ambient Thermal Resistance		V		35			35		°C/W

¹ VCO range = 10, charge pump current = 110, PLL divider = 1693.

² DATAACK load = 15 pF, data load = 5 pF.

$V_D = 3.3\text{ V}$, $V_{DD} = 3.3\text{ V}$, ADC clock = maximum conversion rate, unless otherwise noted.

Table 2.

Parameter	Temp	Test Level	AD9985ABSTZ-110			Unit
			Min	Typ	Max	
RESOLUTION				8		Bits
DC ACCURACY						LSB
Differential Nonlinearity	25°C	I		±0.5	+1.25/−1.0	LSB
	Full	VI			+1.5/−1.0	LSB
Integral Nonlinearity	25°C	I		±0.5	±1.85	LSB
	Full	VI			±3.2	
ANALOG INPUT						
Input Voltage Range						
Minimum	Full	VI			0.5	V p-p
Maximum	Full	VI	1.0			V p-p
Gain Tempco	25°C	V		100		ppm/°C
Input Bias Current	25°C	IV			1	μA
	Full	IV			2	μA
Input Offset Voltage	Full	VI		7		mV
Input Full-Scale Matching	Full	VI		1.5	8.0	% FS
Offset Adjustment Range	Full	VI	46	49	52	% FS
REFERENCE OUTPUT						
Output Voltage	Full	VI		1.25		V
Temperature Coefficient	Full	V		±100		ppm/°C
SWITCHING PERFORMANCE						
Maximum Conversion Rate	Full	VI	110			MSPS
Minimum Conversion Rate	Full	IV			10	MSPS
Data-to-Clock Skew	Full	IV	−0.5		+2.0	ns
t_{BUFF}	Full	VI	4.7			μs
t_{STAH}	Full	VI	4.0			μs
t_{DHO}	Full	VI	300			ns
t_{DAL}	Full	VI	4.7			μs
t_{DAH}	Full	VI	4.0			μs
t_{DSU}	Full	VI	250			ns
t_{STASU}	Full	VI	4.7			μs
t_{STAH}	Full	VI				μs
HSYNC Input Frequency	Full	IV	15		110	kHz
Maximum PLL Clock Rate	Full	VI	110			MHz
Minimum PLL Clock Rate	Full	IV			12	MHz
PLL Jitter	25°C	IV		400	700 ¹	ps p-p
	Full	IV			1000 ¹	ps p-p
Sampling Phase Tempco	Full	IV		15		ps/°C
DIGITAL INPUTS						
Input Voltage, High (V_{IH})	Full	VI	2.5			V
Input Voltage, Low (V_{IL})	Full	VI			0.8	V
Input Current, High (I_{IH})	Full	V			−1.0	μA
Input Current, Low (I_{IL})	Full	V			1.0	μA
Input Capacitance	25°C	V		3		pF
DIGITAL OUTPUTS						
Output Voltage, High (V_{OH})	Full	VI	$V_D - 0.1$			V
Output Voltage, Low (V_{OL})	Full	VI			0.1	V
Duty Cycle, DATAACK	Full	IV	45	50	55	%
Output Coding				Binary		

AD9985A

Parameter	Temp	Test Level	AD9985ABSTZ-110			Unit
			Min	Typ	Max	
POWER SUPPLY						
V _D Supply Voltage	Full	IV	3.15	3.3	3.45	V
V _{DD} Supply Voltage	Full	IV	2.2	3.3	3.45	V
P _{VD} Supply Voltage	Full	IV	3.15	3.3	3.45	V
I _D Supply Current (V _D)	25°C	V		132		mA
I _{DD} Supply Current (V _{DD}) ²	25°C	V		19		mA
I _{PVD} Supply Current (P _{VD})	25°C	V		8		mA
Total Power Dissipation	Full	VI		525	760	mW
Power-Down Supply Current	Full	VI		5	15	mA
Power-Down Dissipation	Full	VI		16.5	50	mW
DYNAMIC PERFORMANCE						
Analog Bandwidth, Full Power	25°C	V		300		MHz
Transient Response	25°C	V		2		ns
Overshoot Recovery Time	25°C	V		1.5		ns
Signal-to-Noise Ratio (SNR)	25°C	V		44		dB
(Without Harmonics)	Full	V		43		dB
f _{IN} = 40.7 MHz						
Crosstalk	Full	V		55		dBc
THERMAL CHARACTERISTICS						
θ _{JC} Junction-to-Case						
Thermal Resistance		V		16		°C/W
θ _{JA} Junction-to-Ambient						
Thermal Resistance		V		35		°C/W

¹ VCO range = 10, charge pump current = 110, PLL divider = 1693.

² DATAACK load = 15 pF, data load = 5 pF.

EXPLANATION OF TEST LEVELS

- I. 100% production tested.
- II. 100% production tested at 25°C and sample tested at specified temperatures.
- III. Sample tested only.
- IV. Parameter is guaranteed by design and characterization testing.
- V. Parameter is a typical value only.
- VI. 100% production tested at 25°C; guaranteed by design and characterization testing.

ABSOLUTE MAXIMUM RATINGS

Table 3.

Parameter	Rating
V_D	3.6 V
V_{DD}	3.6 V
Analog Inputs	V_D to 0.0 V
Digital Inputs	5 V to 0.0 V
Digital Output Current	20 mA
Operating Temperature	-40°C to +85°C
Storage Temperature	-65°C to +150°C
Maximum Junction Temperature	150°C
Maximum Case Temperature	150°C

Stresses above those listed under Absolute Maximum Ratings may cause permanent damage to the device. This is a stress rating only; functional operation of the device at these or any other conditions above those indicated in the operational section of this specification is not implied. Exposure to absolute maximum ratings for extended periods may affect device reliability.

ESD CAUTION

ESD (electrostatic discharge) sensitive device. Electrostatic charges as high as 4000 V readily accumulate on the human body and test equipment and can discharge without detection. Although this product features proprietary ESD protection circuitry, permanent damage may occur on devices subjected to high energy electrostatic discharges. Therefore, proper ESD precautions are recommended to avoid performance degradation or loss of functionality.



PIN CONFIGURATION AND FUNCTION DESCRIPTIONS

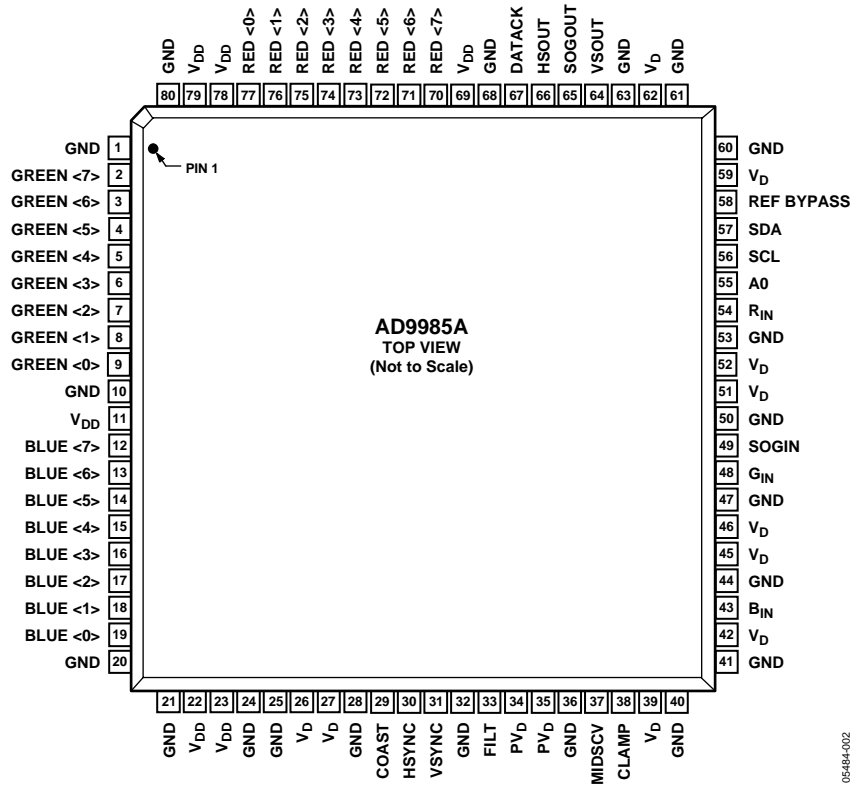

Figure 2. Pin Configuration

Table 4. Complete Pinout List

Pin Type	Mnemonic	Function	Value	Pin No.
Inputs	R _{IN}	Analog Input for Converter R	0.0 V to 1.0 V	54
	G _{IN}	Analog Input for Converter G	0.0 V to 1.0 V	48
	B _{IN}	Analog Input for Converter B	0.0 V to 1.0 V	43
	HSYNC	Horizontal SYNC Input	3.3 V CMOS	30
	VSYNC	Vertical SYNC Input	3.3 V CMOS	31
	SOGIN	Input for Sync-on-Green	0.0 V to 1.0 V	49
	CLAMP	Clamp Input (External Clamp Signal)	3.3 V CMOS	38
	COAST	PLL Coast Signal Input	3.3 V CMOS	29
Outputs	Red [7:0]	Outputs of Converter Red, Bit 7 is the MSB	3.3 V CMOS	70 to 77
	Green [7:0]	Outputs of Converter Green, Bit 7 is the MSB	3.3 V CMOS	2 to 9
	Blue [7:0]	Outputs of Converter Blue, Bit 7 is the MSB	3.3 V CMOS	12 to 19
	DATAACK	Data Output Clock	3.3 V CMOS	67
	HSOUT	HSYNC Output (Phase-Aligned with DATAACK)	3.3 V CMOS	66
	VSOUT	VSYNC Output (Phase-Aligned with DATAACK)	3.3 V CMOS	64
	SOGOUT	Sync-on-Green Slicer Output	3.3 V CMOS	65
References	REF BYPASS	Internal Reference Bypass	1.25 V	58
	MIDSCV	Internal Midscale Voltage Bypass		37
	FILT	Connection for External Filter Components for Internal PLL		33

Pin Type	Mnemonic	Function	Value	Pin No.
Power Supply	V _D	Analog Power Supply	3.3 V	26, 27, 39, 42, 45, 46, 51, 52, 59, 62
	V _{DD}	Output Power Supply	3.3 V	11, 22, 23, 69, 78, 79
	PV _D	PLL Power Supply	3.3 V	34, 35
	GND	Ground	0 V	1, 10, 20, 21, 24, 25, 28, 32, 36, 40, 41, 44, 47, 50, 53, 60, 61, 63, 68, 80
Serial Port (2-Wire)	SDA	Serial Port Data I/O	3.3 V CMOS	57
	SCL	Serial Port Data Clock (100 kHz maximum)	3.3 V CMOS	56
	A0	Serial Port Address Input 1	3.3 V CMOS	55

Table 5. Pin Function Descriptions

Pin	Description
Inputs	
R _{IN}	Analog Input for Red Channel.
G _{IN}	Analog Input for Green Channel.
B _{IN}	Analog Input for Blue Channel. High impedance inputs that accept the red, green, and blue channel graphics signals, respectively. (The three channels are identical, and can be used for any colors, but colors are assigned for convenient reference.) They accommodate input signals ranging from 0.5 V to 1.0 V full scale. Signals should be ac-coupled to these pins to support clamp operation.
HSYNC	Horizontal Sync Input. This input receives a logic signal that establishes the horizontal timing reference and provides the frequency reference for pixel clock generation. The logic sense of this pin is controlled by serial Register 0x0E, Bit 6 (Hsync polarity). Only the leading edge of Hsync is active; the trailing edge is ignored. When Hsync polarity = 0, the falling edge of Hsync is used. When Hsync polarity = 1, the rising edge is active. The input includes a Schmitt trigger for noise immunity, with a nominal input threshold of 1.5 V.
VSYNC	Vertical Sync Input. This is the input for vertical sync.
SOGIN	Sync-on-Green Input. This input is provided to assist with processing signals with embedded sync, typically on the green channel. The pin is connected to a high speed comparator with an internally generated threshold. The threshold level can be programmed in 10 mV steps to any voltage between 10 mV and 330 mV above the negative peak of the input signal. The default voltage threshold is 150 mV. When connected to an ac-coupled graphics signal with embedded sync, it produces a noninverting digital output on SOGOUT. (This is usually a composite sync signal, containing both vertical and horizontal sync information that must be separated before passing the horizontal sync signal to Hsync.) When not used, this input should be left unconnected. For more details on this function and how it should be configured, refer to the Sync-on-Green section.
CLAMP	External Clamp Input. This logic input can be used to define the time during which the input signal is clamped to ground. It should be exercised when the reference dc level is known to be present on the analog input channels, typically during the back porch of the graphics signal. The CLAMP pin is enabled by setting control bit clamp function to 1, (Register 0x0F, Bit 7, default is 0). When disabled, this pin is ignored and the clamp timing is determined internally by counting a delay and duration from the trailing edge of the Hsync input. The logic sense of this pin is controlled by clamp polarity Register 0x0F, Bit 6. When not used, this pin must be grounded and clamp function programmed to 0.
COAST	Clock Generator Coast Input (Optional). This input can be used to cause the pixel clock generator to stop synchronizing with Hsync and continue producing a clock at its current frequency and phase. This is useful when processing signals from sources that fail to produce horizontal sync pulses during the vertical interval. The Coast signal is generally not required for PC-generated signals. The logic sense of this pin is controlled by Coast polarity (Register 0x0F, Bit 3). When not used, this pin can be grounded and Coast polarity programmed to 1, or tied high (to V _D through a 10 kΩ resistor) and Coast polarity programmed to 0. Coast polarity defaults to 1 at power-up.
Outputs	
HSOUT	Horizontal Sync Output. A reconstructed and phase-aligned version of the Hsync input. Both the polarity and duration of this output can be programmed via serial bus registers. By maintaining alignment with DATAACK and Data outputs, data timing with respect to horizontal sync can always be determined.
VSOUT	Vertical Sync Output. A reconstructed and phase-aligned version of the video Vsync. The polarity of this output can be controlled via a serial bus bit. The placement and duration in all modes is set by the graphics transmitter.
SOGOUT	Sync-on-Green Slicer Output. This pin outputs either the signal from the sync-on-green slicer comparator or an unprocessed but delayed version of the Hsync input. See the sync processing block diagram (Figure 14) to view how this pin is connected. (Apart from slicing off SOG, the output from this pin gets no other additional processing on the AD9985A. Vsync separation is performed via the sync separator.)

AD9985A

Pin	Description
Data Outputs RED GREEN BLUE	Data Output, Red Channel. Data Output, Green Channel. Data Output, Blue Channel. The main data outputs. Bit 7 is the MSB. The delay from pixel sampling time to output is fixed. When the sampling time is changed by adjusting the phase register, the output timing is shifted as well. The DATAACK and HSOUT outputs are also moved, so the timing relationship among the signals is maintained. For exact timing information, refer to Figure 9, Figure 10, and Figure 11.
Data Clock Output DATAACK	Data Output Clock. This is the main clock output signal used to strobe the output data and HSOUT into external logic. It is produced by the internal clock generator and is synchronous with the internal pixel sampling clock. When the sampling time is changed by adjusting the phase register, the output timing is shifted as well. The Data, DATAACK, and HSOUT outputs are all moved, so the timing relationship among the signals is maintained.
References REF BYPASS MIDSCV FILT	Internal Reference Bypass. Bypass for the internal 1.25 V band gap reference. It should be connected to ground through a 0.1 μ F capacitor. The absolute accuracy of this reference is $\pm 4\%$, and the temperature coefficient is ± 50 ppm, which is adequate for most AD9985A applications. If higher accuracy is required, an external reference can be used instead. Midscale Voltage Reference Bypass. Bypass for the internal midscale voltage reference. It should be connected to ground through a 0.1 μ F capacitor. The exact voltage varies with the gain setting of the blue channel. External Filter Connection. For proper operation, the pixel clock generator PLL requires an external filter. Connect the filter shown in Figure 6 to this pin. For optimal performance, minimize noise and parasitics on this node.
Power Supply V _D V _{DD} PV _D GND	Main Power Supply. These pins supply power to the main elements of the circuit. They should be filtered and kept as quiet as possible. Digital Output Power Supply. A large number of output pins (up to 25) switching at high speed (up to 110 MHz) generates a lot of power supply transients (noise). These supply pins are identified separately from the V _D pins so special care can be taken to minimize output noise transferred into the sensitive analog circuitry. If the AD9985A is interfacing with lower voltage logic, V _{DD} can be connected to a lower supply voltage (as low as 2.5 V) for compatibility. Clock Generator Power Supply. The most sensitive portion of the AD9985A is the clock generation circuitry. These pins provide power to the clock PLL and help the user design for optimal performance. The designer should provide quiet, noise-free power to these pins. Ground. The ground return for all circuitry on-chip. It is recommended that the AD9985A be assembled on a single solid ground plane, with careful attention given to ground current paths.
Serial Port (2-Wire) SDA SCL A0	Serial Port Data I/O. Serial Port Data Clock. Serial Port Address Input 1. For a full description of the 2-wire serial register and how it works, refer to the 2-Wire Serial Control Port section.

DESIGN GUIDE

GENERAL DESCRIPTION

The AD9985A is a fully integrated solution for capturing analog RGB signals and digitizing them for display on flat panel monitors or projectors. The circuit is ideal for providing a computer interface for HDTV monitors or as the front end to high performance video scan converters. Implemented in a high performance CMOS process, the interface can capture signals with pixel rates up to 110 MHz.

The AD9985A includes all necessary input buffering, signal dc restoration (clamping), offset and gain (brightness and contrast) adjustment, pixel clock generation, sampling phase control, and output data formatting. All controls are programmable via a 2-wire serial interface. Full integration of these sensitive analog functions makes system design straightforward and less sensitive to the physical and electrical environment.

With a typical power dissipation of only 500 mW and an operating temperature range of 0°C to 70°C (–40°C to +85°C for the AD9985ABST), the device requires no special environmental considerations.

DIGITAL INPUTS

All digital inputs on the AD9985A operate to 3.3 V CMOS levels. However, all digital inputs are 5 V tolerant. Applying 5 V to them does not cause any damage.

INPUT SIGNAL HANDLING

The AD9985A has one high impedance analog input pin for each of the red, green, and blue channels. They accommodate signals ranging from 0.5 V to 1.0 V p-p.

Signals are typically brought onto the interface board via a DVI-I connector, a 15-pin D connector, or via BNC connectors. The AD9985A should be located as close as practical to the input connector. Signals should be routed via matched-impedance traces (normally 75 Ω) to the IC input pins.

At this point, the signal should be resistively terminated (75 Ω to the signal ground return) and capacitively coupled to the AD9985A inputs through 47 nF capacitors. These capacitors form part of the dc restoration circuit.

When impedances are perfectly matched, the best performance can be obtained with the widest possible signal bandwidth. The ultrawide bandwidth inputs of the AD9985A (300 MHz) can track the input signal continuously as it moves from one pixel level to the next, and digitize the pixel during a long, flat pixel time. In many systems, however, there are mismatches, reflections, and noise, which can result in excessive ringing and distortion of the input waveform. This makes it more difficult to establish a sampling phase that provides good image quality. It has been shown that a small inductor in series with the input

is effective in rolling off the input bandwidth slightly and providing a high quality signal over a wider range of conditions. Using a Fair-Rite #2508051217Z0 High Speed Signal Chip Bead inductor in the circuit of Figure 3 yields good results in most applications.

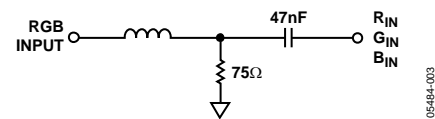

Figure 3. Analog Input Interface Circuit

HSYNC, VSYNC INPUTS

The interface also takes a horizontal sync signal, which is used to generate the pixel clock and clamp timing. This can be either a sync signal directly from the graphics source, or a preprocessed TTL or CMOS level signal.

The Hsync input includes a Schmitt trigger buffer for immunity to noise and signals with long rise times. In typical PC-based graphic systems, the sync signals are simply TTL-level drivers feeding unshielded wires in the monitor cable. As such, no termination is required.

SERIAL CONTROL PORT

The serial control port is designed for 3.3 V logic. If there are 5 V drivers on the bus, these pins should be protected with 150 Ω series resistors placed between the pull-up resistors and the input pins.

OUTPUT SIGNAL HANDLING

The digital outputs are designed and specified to operate from a 3.3 V power supply (V_{DD}). They can also work with a V_{DD} as low as 2.5 V for compatibility with other 2.5 V logic.

CLAMPING

RGB Clamping

To properly digitize the incoming signal, the dc offset of the input must be adjusted to fit the range of the on-board ADCs.

Most graphics systems produce RGB signals with black at ground and white at approximately 0.75 V. However, if sync signals are embedded in the graphics, the sync tip is often at ground, black is at 300 mV, and white is at approximately 1.0 V. Some common RGB line amplifier boxes use emitter-follower buffers to split signals and increase drive capability. This introduces a 700 mV dc offset to the signal, which must be removed for proper capture by the AD9985A.

The key to clamping is to identify a portion (time) of the signal when the graphic system is known to be producing black. An offset is then introduced that results in the ADCs producing a

black output (code 0x00) when the known black input is present. The offset then remains in place when other signal levels are processed, and the entire signal is shifted to eliminate offset errors.

In most PC graphics systems, black is transmitted between active video lines. With CRT displays, when the electron beam has completed writing a horizontal line on the screen (at the right side), the beam is deflected quickly to the left side of the screen (called horizontal retrace), and a black signal is provided to prevent the beam from disturbing the image.

In systems with embedded sync, a blacker-than-black signal (Hsync) is produced briefly to signal the CRT that it is time to begin a retrace. For obvious reasons, it is important to avoid clamping on the tip of Hsync. Fortunately, there is virtually always a period following Hsync, called the back porch, when a good black reference is provided. This is the time when clamping should be performed.

The clamp timing can be established by simply exercising the CLAMP pin at the appropriate time (with External Clamp = 1). The polarity of this signal is set by the clamp polarity bit.

A simpler method of clamp timing uses the AD9985A internal clamp timing generator. The clamp placement register is programmed with the number of pixel times that should pass after the trailing edge of Hsync before clamping starts. A second register (clamp duration) sets the duration of the clamp. These are both 8-bit values, which provide considerable flexibility in clamp generation. The clamp timing is referenced to the trailing edge of Hsync because, though Hsync duration can vary widely, the back porch (black reference) always follows Hsync. A good starting point for establishing clamping is to set the clamp placement to 0x09 (providing 9 pixel periods for the graphics signal to stabilize after sync) and set the clamp duration to 0x14 (giving the clamp 20 pixel periods to re-establish the black reference).

Clamping is accomplished by placing an appropriate charge on the external input coupling capacitor. The value of this capacitor affects the performance of the clamp. If it is too small, there is a significant amplitude change during a horizontal line time (between clamping intervals). If the capacitor is too large, it takes excessively long for the clamp to recover from a large change in incoming signal offset. The recommended value (47 nF) results in recovering from a step error of 100 mV to within 1/2 LSB in 10 lines with a clamp duration of 20 pixel periods on a 60 Hz SXGA signal.

YUV Clamping

YUV graphics signals are slightly different from RGB signals, as the dc reference level (black level in RGB signals) can be at the midpoint of the graphics signal rather than at the bottom. For these signals, it might be necessary to clamp to the midscale

range of the ADC range (0x80) rather than at the bottom of the ADC converter range (0x00).

Clamping to midscale rather than to ground can be accomplished by setting the clamp select bits in the serial bus register. Each of the three converters has its own selection bit so that they can be clamped to either midscale or ground independently. These bits are located in Register 0x10, Bits [2:0]. The midscale reference voltage that each ADC clamps to is provided on the MIDSCV pin (Pin 37). This pin should be bypassed to ground with a 0.1 μ F capacitor, even if midscale clamping is not required.

GAIN AND OFFSET CONTROL

The AD9985A can accommodate input signals with inputs ranging from 0.5 V to 1.0 V full scale. The full-scale range is set in three 8-bit registers (red gain, green gain, and blue gain). Note that increasing the gain setting results in an image with less contrast.

The offset control shifts the entire input range, resulting in a change in image brightness. Three 7-bit registers (red offset, green offset, blue offset) provide independent settings for each channel. The offset controls provide a ± 63 LSB adjustment range. This range is connected with the full-scale range, so if the input range is doubled (from 0.5 V to 1.0 V), the offset step size is also doubled (from 2 mV per step to 4 mV per step).

Figure 4 shows the interaction of gain and offset controls. The magnitude of an LSB in offset adjustment is proportional to the full-scale range, so changing the full-scale range also changes the offset. The change is minimal if the offset setting is near midscale. When changing the offset, the full-scale range is not affected, but the full-scale level is shifted by the same amount as the zero-scale level.

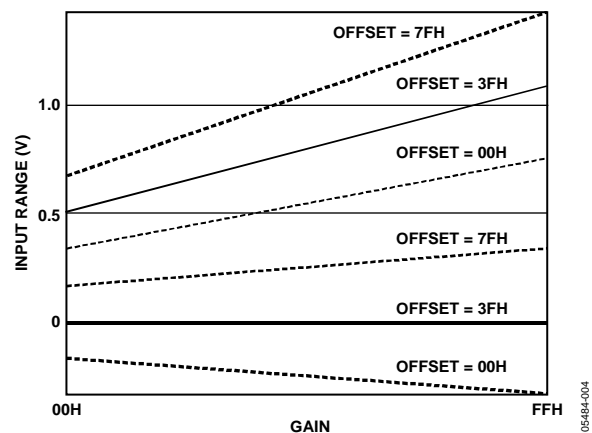

Figure 4. Gain and Offset Control

Auto Offset

In addition to the manual offset adjustment mode (via registers 0x0B to 0x0D), the AD9985A also includes circuitry to automatically calibrate the offset for each channel. By monitoring

the output of each ADC during the back porch of the input signals, the AD9985A can self-adjust to eliminate any offset errors in its own ADC channels, as well as any offset errors present on the incoming graphics or video signals.

To activate the auto offset mode, set Register 0x1D, Bit 7 to 1. Next, the target code registers (0x19 through 0x1B) must be programmed. The values programmed into the target code registers should be the output code desired from the AD9985A during the back porch reference time. For example, for RGB signals, all three registers are normally programmed to code 1, while for YPbPr signals, the green (Y) channel is normally programmed to code 1, and the blue and red channels (Pb and Pr) are normally set to 128. Any target code value between 1 and 254 can be set, although the AD9985A's offset range may not be able to reach every value. Intended target code values range from (but are not limited to) 1 to 40 when ground clamping, and 90 to 170 when midscale clamping.

The ability to program a target code for each channel gives users a large degree of freedom and flexibility. While in most cases all channels are set either to 1 or 128, the flexibility to select other values allows the possibility of inserting intentional skews between channels. It also allows the ADC range to be skewed so that voltages outside of the normal range can be digitized. For example, setting the target code to 40 allows the sync tip, which is normally below black level, to be digitized and evaluated.

Lastly, when in auto offset mode, the manual offset registers (0x0B to 0x0D) have new functionality. The values in these registers are digitally added to the value of the ADC output. The purpose of doing this is to match a benefit that is present with manual offset adjustment. Adjusting these registers is an easy way to make brightness adjustments. Although some signal range is lost with this method, it has proven to be a very popular function. In order to be able to increase and decrease brightness, the values in these registers in this mode are signed twos complement. The digital adder is only used in auto offset mode. Although it cannot be disabled, setting the offset registers to all 0s effectively disables it by always adding 0.

SYNC-ON-GREEN

The sync-on-green input operates in two steps. First, it sets a baseline clamp level off of the incoming video signal with a negative peak detector. Second, it sets the sync trigger level to a programmable level (typically 150 mV) above the negative peak. The sync-on-green input must be ac-coupled to the green analog input through its own capacitor, as shown in Figure 5. The value of the capacitor must be 1 nF \pm 20%. If sync-on-green is not used, this connection is not required. The sync-on-green signal is always negative polarity.

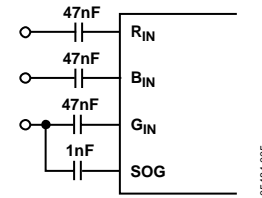

Figure 5. Typical Clamp Configuration

CLOCK GENERATION

A phase-locked loop (PLL) is used to generate the pixel clock. In this PLL, the Hsync input provides a reference frequency. A voltage controlled oscillator (VCO) generates a much higher pixel clock frequency. This pixel clock is divided by the PLL divide value (Register 0x01 and Register 0x02) and phase compared with the Hsync input. Any error is used to shift the VCO frequency and maintain lock between the two signals.

The stability of this clock is a very important element in providing the clearest and most stable image. During each pixel time, there is a period during which the signal is slewing from the old pixel amplitude and settling at its new value. Then, there is a time when the input voltage is stable before the signal must slew to a new value (Figure 6). The ratio of the slewing time to the stable time is a function of the bandwidth of the graphics DAC and the bandwidth of the transmission system (cable and termination). It is also a function of the overall pixel rate. Clearly, if the dynamic characteristics of the system remain fixed, the slewing and settling time is, likewise, fixed. This time must be subtracted from the total pixel period, leaving the stable period. At higher pixel frequencies, the total cycle time is shorter, and the stable pixel time also becomes shorter.

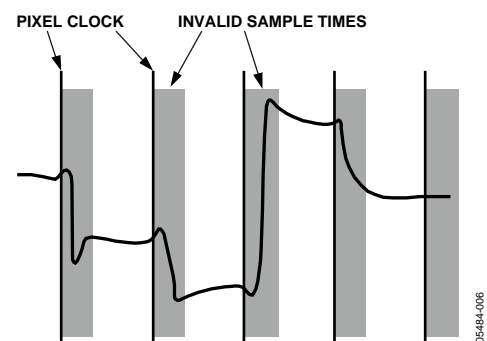

Figure 6. Pixel Sampling Times

Any jitter in the clock reduces the precision with which the sampling time can be determined, and must also be subtracted from the stable pixel time.

Considerable care has been taken in the design of the AD9985A's clock generation circuit to minimize jitter. As shown in Figure 7, the clock jitter of the AD9985A is less than 5% of the total pixel time in all operating modes, making the reduction in the valid sampling time negligible due to jitter.

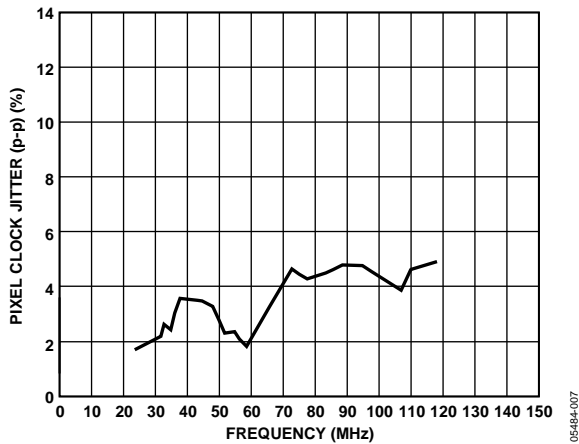

Figure 7. Pixel Clock Jitter vs. Frequency

The PLL characteristics are determined by the loop filter design, the PLL charge pump current, and the VCO range setting. The loop filter design is shown in Figure 8. Recommended settings of VCO range and charge pump current for VESA standard display modes are listed in Table 9.

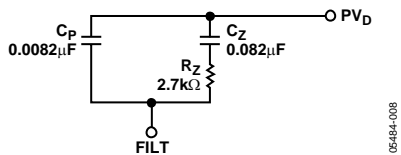

Figure 8. PLL Loop Filter Detail

Four programmable registers are provided to optimize the performance of the PLL.

12-Bit Divisor Register

The input Hsync frequencies range from 15 kHz to 110 kHz. The PLL multiplies the frequency of the Hsync signal, producing pixel clock frequencies in the range of 12 MHz to 110 MHz. The divisor register controls the exact multiplication factor. This register can be set to any value between 221 and 4095. (The divide ratio that is actually used is the programmed divide ratio plus 1.)

2-Bit VCO Range Register

To improve the noise performance of the AD9985A, the VCO operating frequency range is divided into three overlapping regions. The VCO range register sets this operating range. Table 6 shows the frequency ranges for the lowest and highest regions.

Table 6. VCO Frequency Ranges

PV1	PV0	Pixel Clock Range (MHz)	
		AD9985AKSTZ	AD9985ABSTZ
0	0	12 to 32	12 to 30
0	1	32 to 64	30 to 60
1	0	64 to 110	60 to 110
1	1	110 to 140	

3-Bit Charge Pump Current Register

This register allows the current that drives the low-pass loop filter to be varied. The possible current values are listed in Table 7.

Table 7. Charge Pump Current/Control Bits

Ip2	Ip1	Ip0	Current (µA)
0	0	0	50
0	0	1	100
0	1	0	150
0	1	1	250
1	0	0	350
1	0	1	500
1	1	0	750
1	1	1	1500

5-Bit Phase Adjust Register

The phase of the generated sampling clock can be shifted to locate an optimum sampling point within a clock cycle. The phase adjust register provides 32 phase-shift steps of 11.25° each. The Hsync signal with an identical phase shift is available through the HSOUT pin.

The COAST pin is used to allow the PLL to continue to run at the same frequency in the absence of the incoming Hsync signal or during disturbances in Hsync (such as equalization pulses). This can be used during the vertical sync period, or any other time that the Hsync signal is unavailable. The polarity of the Coast signal is set through the Coast polarity register. Also, the polarity of the Hsync signal is set through the Hsync polarity register. If not using automatic polarity detection, the Hsync and Coast polarity bits should be set to match the respective polarities of the input signals.

POWER MANAGEMENT

The AD9985A uses the activity detect circuits, the active interface bits in the serial bus, the active interface override bits, and the power-down bit to determine the correct power state. The three power states are full-power, seek mode, and power-down. Table 8 summarizes how the AD9985A determines which power mode to be in and which circuitry is powered on/off in each of these modes. The power-down command has priority over the automatic circuitry.

Table 8. Power-Down Mode Descriptions

Mode	Inputs Power-Down ¹	Sync Detect ²	Powered On or Comments
Full-Power	1	1	Everything
Seek Mode	1	0	Serial Bus, Sync Activity Detect, SOG, Band Gap Reference
Power-Down	0	X	Serial Bus, Sync Activity Detect, SOG, Band Gap Reference

¹ Power-down is controlled via Bit 1 in Serial Bus Register 0x0F.

² Sync detect is determined by OR'ing Bits 7, 4, and 1 in Serial Bus Register 0x14.

Table 9. Recommended VCO Range and Charge Pump Current Settings for Standard Display Formats

Standard Modes	Resolution	Refresh Rate	Horizontal Frequency	Pixel Rate	PLL Div	AD9985AKSTZ		AD9985ABSTZ	
						VCORNGE	Current	VCORNGE	Current
VGA	640 × 480	60 Hz	31.5 kHz	25.175 MHz	799	00	110	00	011
		72 Hz	37.7 kHz	31.500 MHz	835	00	110	01	010
		75 Hz	37.5 kHz	31.500 MHz	841	00	110	01	010
		85 Hz	43.3 kHz	36.000 MHz	831	01	100	01	010
SVGA	800 × 600	56 Hz	35.1 kHz	36.000 MHz	1025	01	100	01	010
		60 Hz	37.9 kHz	40.000 MHz	1055	01	100	01	011
		72 Hz	48.1 kHz	50.000 MHz	1039	01	101	01	100
		75 Hz	46.9 kHz	49.500 MHz	1055	01	101	01	100
		85 Hz	53.7 kHz	56.250 MHz	1047	01	101	01	101
XGA	1024 × 768	60 Hz	48.4 kHz	65.000 MHz	1343	10	101	10	011
		70 Hz	56.5 kHz	75.000 MHz	1327	10	100	10	011
		75 Hz	60.0 kHz	78.750 MHz	1313	10	100	10	011
		80 Hz	64.0 kHz	85.500 MHz	1335	10	101	10	100
		85 Hz	68.3 kHz	94.500 MHz	1383	10	101	10	100
SXGA	1280 × 1024	60 Hz	64.0 kHz	108.000 MHz	1687	10	110	10	101
		75 Hz	80.0 kHz	135.000 MHz	1687	11	110		
TV Modes									
480i	720 × 480	60Hz	15.75 kHz	13.51MHz	857	00	011	00	011
480p	720 × 483	60Hz	31.47 kHz	27.00 MHz	857	00	110	00	011
720p	1280 × 720	60Hz	45.0 kHz	74.25 MHz	1649	10	100	10	011
1080i	1920 × 1080	60Hz	33.75 kHz	74.25 MHz	2199	10	100	10	011

TIMING

The timing diagrams in this section show the operation of the AD9985A.

The output data clock signal is created so that its rising edge always occurs between data transitions, and can be used to latch the output data externally.

The pipeline in the AD9985A must be flushed before valid data becomes available. This means that four data sets are presented before valid data is available.

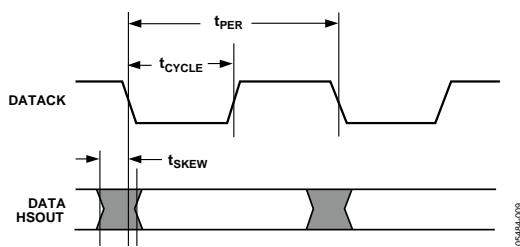

Figure 9. Output Timing

Hsync TIMING

Hsync is processed in the AD9985A to eliminate ambiguity in the timing of the leading edge with respect to the phase-delayed pixel clock and data.

The Hsync input is used as a reference to generate the pixel sampling clock. The sampling phase can be adjusted, with respect to Hsync, through a full 360° in 32 steps via the phase adjust register (to optimize the pixel sampling time). Display systems use Hsync to align memory and display write cycles; therefore, it is important to have a stable timing relationship between Hsync output (HSOUT) and data clock (DATAACK).

Three things happen to Horizontal Sync in the AD9985A. First, the polarity of Hsync input is determined and thus has a known output polarity. The known output polarity can be programmed either active high or active low (Register 0x0E, Bit 5). Second, HSOUT is aligned with DATAACK and data outputs. Third, the duration of HSOUT (in pixel clocks) is set via Register 0x07. HSOUT is the sync signal that should be used to drive the rest of the display system.

COAST TIMING

In most computer systems, the Hsync signal is provided continuously on a dedicated wire. In these systems, the Coast input and function are unnecessary and should not be used, and the pin should be permanently connected to the inactive state.

In some systems, however, Hsync is disturbed during the vertical sync period (Vsync). In some cases, Hsync pulses disappear. In other systems, such as those that use composite sync (Csync) signals or embedded sync-on-green (SOG), Hsync includes equalization pulses or other distortions during Vsync. To avoid upsetting the clock generator during Vsync, it is

important to ignore these distortions. If the pixel clock PLL detects extraneous pulses, it attempts to lock to this new frequency, and changes frequency by the end of the Vsync period. It then takes a few lines of correct Hsync timing to recover at the beginning of a new frame, resulting in a tearing of the image at the top of the display.

The Coast input is provided to eliminate this problem. It is an asynchronous input that disables the PLL input and allows the clock to free-run at its then-current frequency. The PLL can free-run for several lines without significant frequency drift.

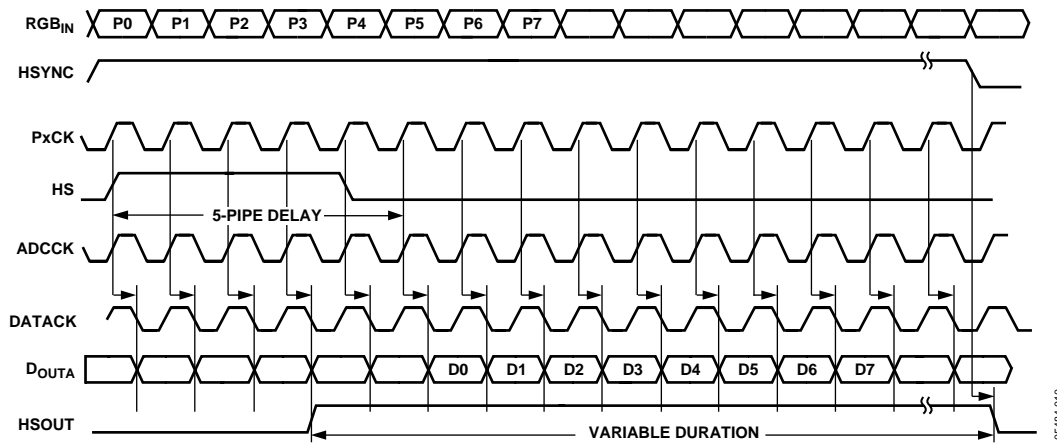

Figure 10. 4:4:4 Mode (For RGB and YUV)

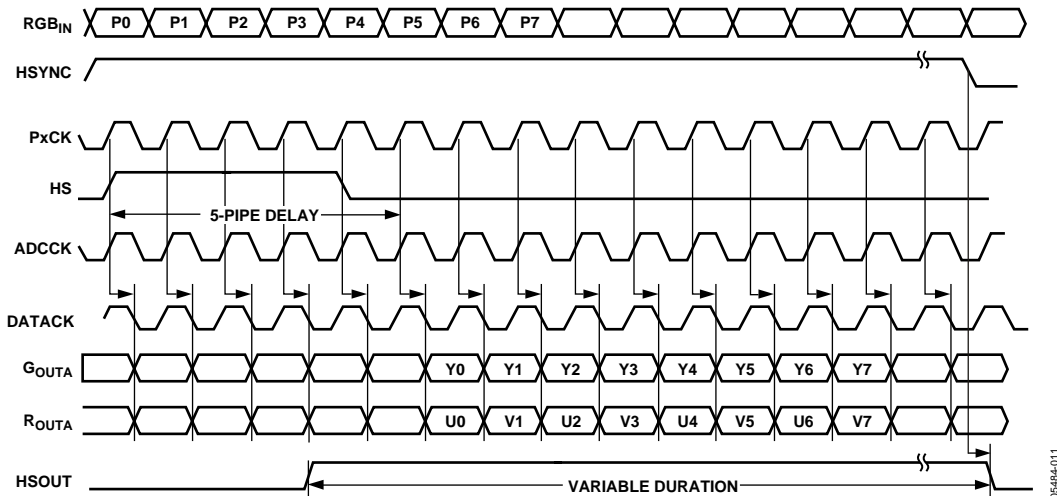

Figure 11. 4:2:2 Mode (For YUV Only)

2-WIRE SERIAL REGISTER MAP

The AD9985A is initialized and controlled by a set of registers that determine the operating modes. An external controller is used to write and read the control registers through the two-line serial interface port.

Table 10. Control Register Map

Hexadecimal Address	Write and Read or Read-Only	Bits	Default Value	Register Name	Function
0x00	RO	7:0		Chip Revision	An 8-bit register that represents the silicon revision level.
0x01 ¹	R/W	7:0	01101001	PLL Div MSB	This register is for Bits [11:4] of the PLL divider. Greater values mean the PLL operates at a faster rate. This register should be loaded first whenever a change is needed. This will give the PLL more time to lock.
0x02 ¹	R/W	7:4	1101****	PLL Div LSB	Bits [7:4] of this word are written to the LSBs [3:0] of the PLL divider word.
0x03	R/W	7:3	01***** **001***		Bits [7:6] VCO Range. Selects VCO frequency range. (See the PLL description.) Bits [5:3] Charge Pump Current. Varies the current that drives the low-pass filter. (See the PLL description.)
0x04	R/W	7:3	10000***	Phase Adjust	ADC Clock Phase Adjustment. Larger values mean more delay. (1 LSB = T/32)
0x05	R/W	7:0	10000000	Clamp Placement	Places the clamp signal an integer number of clock periods after the trailing edge of the Hsync signal.
0x06	R/W	7:0	10000000	Clamp Duration	Number of clock periods that the clamp signal is actively clamping.
0x07	R/W	7:0	00100000	Hsync Output Pulse Width	Sets the number of pixel clocks that HSOUT will remain active.
0x08	R/W	7:0	10000000	Red Gain	Controls the ADC input range (contrast) of each respective channel. Greater values give less contrast.
0x09	R/W	7:0	10000000	Green Gain	
0x0A	R/W	7:0	10000000	Blue Gain	
0x0B	R/W	7:1	1000000*	Red Offset	Controls dc offset (brightness) of each respective channel. Greater values decrease brightness.
0x0C	R/W	7:1	1000000*	Green Offset	
0x0D	R/W	7:1	1000000*	Blue Offset	
0x0E	R/W	7:0	0***** *1***** **0***** ***0**** ****0*** *****0** *****0* *****0	Sync Control	Bit 7—Hsync Polarity Override. (Logic 0 = polarity determined by chip, Logic 1 = polarity set by Bit 6 in Register 0x0E.) Bit 6—Hsync Input Polarity. Indicates polarity of incoming Hsync signal to the PLL. (Logic 0 = active low, Logic 1 = active high.) Bit 5—Hsync Output Polarity. (Logic 0 = logic high sync, Logic 1 = logic low sync.) Bit 4—Active Hsync Override. If set to Logic 1, the user can select the Hsync to be used via Bit 3. If set to Logic 0, the active interface is selected via Bit 6 in Register 0x14. Bit 3—Active Hsync Select. Logic 0 selects Hsync as the active sync. Logic 1 selects sync-on-green as the active sync. Note that the indicated Hsync is used only if Bit 4 is set to Logic 1 or if both syncs are active. (Bits 1, 7 = Logic 1 in Register 0x14.) Bit 2—Vsync Output Invert. (Logic 1 = no invert, Logic 0 = invert.) Bit 1—Active Vsync Override. If set to Logic 1, the user can select the Vsync to be used via Bit 0. If set to Logic 0, the active interface is selected via Bit 3 in Register 0x14. Bit 0—Active Vsync Select. Logic 0 selects raw Vsync as the output Vsync. Logic 1 selects sync separated Vsync as the output Vsync. Note that the indicated Vsync is used only if Bit 1 is set to Logic 1.
0x0F	R/W	7:1	0*****		Bit 7—Clamp Function. Chooses between Hsync for clamp signal or another external signal to be used for clamping. (Logic 0 = Hsync, Logic 1 = Clamp.)

AD9985A

Hexadecimal Address	Write and Read or Read-Only	Bits	Default Value	Register Name	Function
			*1***** **0***** ***0**** ****1*** *****1** *****1*		Bit 6—Clamp Polarity. Valid only with external clamp signal. (Logic 0 = active high, Logic 1 selects active low.) Bit 5—Coast Select. Logic 0 selects the COAST input pins to be used for the PLL coast. Logic 1 selects Vsync to be used for the PLL coast. Bit 4—Coast Polarity Override. (Logic 0 = polarity determined by chip, Logic 1 = polarity set by Bit 3 in Register 0x0F.) Bit 3—Coast Polarity. Selects polarity of external Coast signal (Logic 0 = active low, Logic 1 = active high). Bit 2—Seek Mode Override (Logic 1 = allow low power mode, Logic 0 = disallow low power mode). Bit 1—PWRDN. Full Chip Power-Down, Active Low (Logic 0 = full chip power-down, Logic 1 = normal).
0x10	R/W	7:3	10111*** *****0** *****0* *****0	Sync-on-Green Threshold	Sync-on-Green Threshold. Sets the voltage level of the sync-on-green slicer's comparator. Bit 2—Red Clamp Select. Logic 0 selects clamp to ground. Logic 1 selects clamp to midscale (voltage at Pin 37). Bit 1—Green Clamp Select. Logic 0 selects clamp to ground. Logic 1 selects clamp to midscale (voltage at Pin 37). Bit 0—Blue Clamp Select. Logic 0 selects clamp to ground. Logic 1 selects clamp to midscale (voltage at Pin 37).
0x11	R/W	7:0	00100000	Sync Separator Threshold	Sync Separator Threshold. Sets the number of internal 5 MHz clock periods the sync separator counts to before toggling high or low. This should be set to some number greater than the maximum Hsync or equalization pulse width.
0x12	R/W	7:0	00000000	Pre-Coast	Pre-Coast. Sets the number of Hsync periods that Coast becomes active prior to Vsync.
0x13	R/W	7:0	00000000	Post-Coast	Post-Coast. Sets the number of Hsync periods that Coast stays active following Vsync.
0x14	RO	7:0		Sync Detect	Bit 7—Hsync detect. It is set to Logic 1 if Hsync is present on the analog interface; otherwise it is set to Logic 0. Bit 6—AHS: Active Hsync. This bit indicates which analog Hsync is being used (Logic 0 = Hsync input pin, Logic 1 = Hsync from sync-on-green). Bit 5—Input Hsync Polarity Detect (Logic 0 = active low, Logic 1 = active high). Bit 4—Vsync Detect. It is set to Logic 1 if Vsync is present on the analog interface; otherwise it is set to Logic 0. Bit 3—AVS: Active Vsync. This bit indicates which analog Vsync is being used (Logic 0 = Vsync input pin, Logic 1 = Vsync from sync separator). Bit 2—Output Vsync Polarity Detect (Logic 0 = active low, Logic 1 = active high). Bit 1—Sync-on-Green Detect. It is set to Logic 1 if sync is present on the green video input; otherwise it is set to 0. Bit 0—Input Coast Polarity Detect (Logic 0 = active low, Logic 1 = active high).
0x15	R/W	7:2 1 0	111111** *****1* *****1	Reserved Output Formats Reserved	Bits [7:2] Reserved for future use. Must be written to 111111 for proper operation. Bit 1—4:2:2 Output Formatting Mode (Logic 0 = 4:2:2 mode, Logic 1 = 4:4:4 mode). Bit 0—Must be set to 0 for proper operation.

Hexadecimal Address	Write and Read or Read-Only	Bits	Default Value	Register Name	Function
0x16	R/W	7	0*****	Extra PLL Divider	Bit 7—Extra PLL Divider. (Logic 0 = off, Logic 1 = extra divide-by-2).
		6:5	*00*****	SOGIN Bandwidth Control	Bits [6:5]—SOGIN Bandwidth Control; 00 = 300 MHz; 01 or 10 = 13 MHz; 11 = 6.5 MHz.
		4	***0****	Analog Input Bandwidth Control	Bit 4—Sets the bandwidth of the red, green and blue analog inputs. (Logic 0 = 300 MHz, Logic 1 = 7 MHz).
		3:0	****0000	Reserved	Reserved.
0x17	RO	7:0		Test Register	Reserved.
0x18	RO	7:0		Test Register	Reserved.
0x19	R/W	7:0	00000100	Red Target Code	Target Code for Auto-Offset Operation.
0x1A	R/W	7:0	00000100	Green Target Code	Target Code for Auto-Offset Operation.
0x1B	R/W	7:0	00000100	Blue Target Code	Target Code for Auto-Offset Operation.
0x1C	R/W	7:0	00010001	Reserved	Must be written to 0x11 for proper operation.
0x1D	R/W	7	0*****	Auto Offset Enable	Enables the auto-offset circuitry.
		6	*0*****	Hold Auto Offset	Holds the offset output of the auto-offset at the current value.
		5:2	**1001**	Reserved	Must be written to 9 for proper operation.
		1:0	*****10	Update Mode	Changes the update rate of the auto-offset.
0x1E	R/W	7:0	0000****	Test Register	Must be set to default value.

¹ The AD9985A only updates the PLL divide ratio when the LSBs are written to (Register 0x02).

2-WIRE SERIAL CONTROL REGISTER DETAIL CHIP IDENTIFICATION

00 7–0 Chip Revision

An 8-bit register that represents the silicon revision.

PLL DIVIDER CONTROL

01 7–0 PLL Divide Ratio MSBs

The 8 most significant bits of the 12-bit PLL divide ratio PLLDIV. (The operational divide ratio is PLLDIV + 1.)

The PLL derives a master clock from an incoming Hsync signal. The master clock frequency is then divided by an integer value, such that the output is phase-locked to Hsync. This PLLDIV value determines the number of pixel times (pixels plus horizontal blanking overhead) per line. This is typically 20% to 30% more than the number of active pixels in the display.

The 12-bit value of the PLL divider supports divide ratios from 2 to 4095. The higher the value loaded in this register, the higher the resulting clock frequency with respect to a fixed Hsync frequency.

VESA has established some standard timing specifications that assist in determining the value for PLLDIV as a function of horizontal and vertical display resolution and frame rate (Table 8).

However, many computer systems do not conform precisely to the recommendations, and these numbers should be used only as a guide. The display system manufacturer should provide automatic or manual means for optimizing PLLDIV. An incorrectly set PLLDIV usually produces one or more vertical noise bars on the display. The greater the error, the greater the number of bars produced.

The power-up default value of PLLDIV is 1693 (PLLDIVM = 0x69, PLLDIVL = 0xDx).

The AD9985A updates the full-divide ratio only when the LSBs are changed. Writing to the MSB by itself does not trigger an update.

02 7–4 PLL Divide Ratio LSBs

The 4 least significant bits of the 12-bit PLL divide ratio PLLDIV. The operational divide ratio is PLLDIV + 1.

AD9985A

The power-up default value of PLLDIV is 1693 (PLLDIVM = 0x69, PLLDIVL = 0xDx). The AD9985A updates the full divide ratio only when this register is written to.

CLOCK GENERATOR CONTROL

03 7–6 VCO Range Select

Two bits that establish the operating range of the clock generator.

VCORNGE must be set to correspond with the desired operating frequency (incoming pixel rate).

The PLL gives the best jitter performance at high frequencies. For this reason, to output low pixel rates and still get good jitter performance, the PLL actually operates at a higher frequency but then divides down the clock rate afterwards. Table 11 shows the pixel rates for each VCO range setting. The PLL output divisor is automatically selected with the VCO range setting.

Table 11. VCO Ranges

PV1	PV0	Pixel Clock Range (MHz)	
		AD9985AKSTZ	AD9985ABSTZ
0	0	12 to 32	12 to 30
0	1	32 to 64 (power-up default)	30 to 60 (power-up default)
1	0	64 to 110	60 to 110
1	1	110 to 140	

03 5–3 Current Charge Pump Current

Three bits that establish the current driving the loop filter in the clock generator.

Current must be set to correspond with the desired operating frequency (incoming pixel rate).

Table 12. Charge Pump Currents

CURRENT	Current (µA)
000	50
001	100 (power-up default)
010	150
011	250
100	350
101	500
110	750
111	1500

04 7–3 Clock Phase Adjust

A 5-bit value that adjusts the sampling phase in 32 steps across one pixel time. Each step represents an 11.25° shift in sampling phase.

The power-up default value is 16.

CLAMP TIMING

05 7–0 Clamp Placement

An 8-bit register that sets the position of the internally generated clamp.

When clamp function (Register 0x0F, Bit 7) = 0, a clamp signal is generated internally, at a position established by the clamp placement and for a duration set by the clamp duration. Clamping is started (clamp placement) pixel periods after the trailing edge of Hsync. The clamp placement can be programmed to any value between 1 and 255.

The clamp should be placed during a time that the input signal presents a stable black-level reference, usually the back porch period between Hsync and the image.

When clamp function = 1, this register is ignored.

06 7–0 Clamp Duration

An 8-bit register that sets the duration of the internally generated clamp.

For the best results, the clamp duration should be set to include the majority of the black reference signal time that follows the Hsync signal trailing edge. Insufficient clamping time can produce brightness changes at the top of the screen, and a slow recovery from large changes in the average picture level (APL), or brightness.

When clamp function = 1, this register is ignored.

HSYNC PULSE WIDTH

07 7–0 Hsync Output Pulse Width

An 8-bit register that sets the duration of the Hsync output pulse.

The leading edge of the Hsync output is triggered by the internally generated, phase-adjusted PLL feedback clock. The AD9985A then counts a number of pixel clocks equal to the value in this register. This triggers the trailing edge of the Hsync output, which is also phase adjusted.

INPUT GAIN

08 7–0 Red Channel Gain Adjust (REDGAIN)

An 8-bit word that sets the gain of the red channel. The AD9985A can accommodate input signals with a full-scale range of between 0.5 V and 1.0 V p-p. Setting REDGAIN to 255 corresponds to a 1.0 V input range. A REDGAIN of 0 establishes a 0.5 V input range. Increasing REDGAIN results in the picture having less contrast (the input signal uses fewer of the available converter codes). See Figure 4.

09 **7-0 Green Channel Gain Adjust (GREENGAIN)**
An 8-bit word that sets the gain of the green channel.
See REDGAIN (08).

0A **7-0 Blue Channel Gain Adjust (BLUEGAIN)**
An 8-bit word that sets the gain of the blue channel.
See REDGAIN (08).

INPUT OFFSET

0B **7-1 Red Channel Offset Adjust**
This offset register and those that follow have two modes of operation. One mode is when the auto offset function is turned off (manual mode) and the other is when auto offset is turned on.

When in manual offset adjustment mode (auto offset turned off), this register behaves exactly like the AD9883A. It is a 7-bit offset binary word that sets the dc offset of the red channel. One LSB of offset adjustment equals approximately one LSB change in the ADC offset. Therefore, the absolute magnitude of the offset adjustment scales as the gain of the channel is changed. A nominal setting of 63 results in the channel nominally clamping the back porch (during the clamping interval) to Code 00. An offset setting of 127 results in the channel clamping to Code 64 of the ADC. An offset setting of 0 clamps to Code -63 (off the bottom of the range). Increasing the value of red offset decreases the brightness of the channel.

When in auto offset mode, the value in this register is digitally added to the red channel ADC output. The purpose of doing this is to match the operation with manual offset adjustment. Adjusting these registers is an easy way to make brightness adjustments. Although some signal range is lost with this method, it has proven to be a very popular function. In order to be able to increase and decrease brightness, the values in these registers in this mode are signed twos complement (vs. manual mode, where the values in this register are binary). The digital adder is used only in auto offset mode. Although it cannot be disabled, setting this register to all 0s effectively disables it by always adding 0.

0C **7-1 Green Channel Offset Adjust**
This register works exactly like the Red Channel Offset Adjust Register (0x0B), except it is for the green channel.

0D **7-1 Blue Channel Offset Adjust**
This register works exactly like the Red Channel Offset Adjust register (0x0B), except it is for the blue channel.

MODE CONTROL 1

0E **7 Hsync Input Polarity Override**
This register is used to override the internal circuitry that determines the polarity of the Hsync signal going into the PLL.

Table 13. Hsync Input Polarity Override Settings

Override	Result
0	Hsync polarity determined by chip
1	Hsync polarity determined by user

The default for Hsync polarity override is 0 (polarity determined by chip).

0E **6 HSPOL Hsync Input Polarity**
A bit that must be set to indicate the polarity of the Hsync signal that is applied to the PLL Hsync input.

Table 14. Hsync Input Polarity Settings

Polarity	Result
0	Active low
1	Active high (power-up default)

Active low means the leading edge of the Hsync pulse is negative-going. All timing is based on the leading edge of Hsync, which is the falling edge. The rising edge has no effect.

Active high is inverted from the traditional Hsync, with a positive-going pulse. This means that timing is based on the leading edge of Hsync, which is now the rising edge.

The device operates if this bit is set incorrectly, but the internally generated clamp position, as established by clamp placement (Register 0x05), is not placed as expected, which can generate clamping errors.

0E **5 Hsync Output Polarity**
This bit determines the polarity of the Hsync output and the SOG output. Table 15 shows the effect of this option. SYNC indicates the logic state of the sync pulse.

Table 15. Hsync Output Polarity Settings

Polarity	Result
0	Logic 1 (positive polarity; power-up default)
1	Logic 0 (negative polarity)

0E **4 Active Hsync Override**
This bit is used to override the automatic Hsync selection. To override, set this bit to Logic 1. When overriding, the active Hsync is set via Bit 3 in this register.

Table 16. Active Hsync Override Settings

Override	Result
0	Autodetermines the active interface (power-up default)
1	Override, Bit 3 determines the active interface

0E 3 Active Hsync Select

This bit is used under two conditions. It is used to select the active Hsync when the override bit is set (Bit 4). Alternately, it is used to determine the active Hsync when not overriding, but both Hsyncs are detected.

Table 17. Active Hsync Select Settings

Select	Result
0	Hsync input (power-up default)
1	Sync-on-green input

0E 2 Vsync Output Invert

This bit inverts the polarity of the Vsync output. Table 18 shows the effect of this option.

Table 18. Vsync Output Invert Settings

Invert	Vsync Output
0	Invert (power-up default)
1	No invert

0E 1 Active Vsync Override

This bit is used to override the automatic Vsync selection. To override, set this bit to Logic 1. When overriding, the active interface is set via Bit 0 in this register.

Table 19. Active Vsync Override Settings

Override	Result
0	Autodetermines the active Vsync (power-up default)
1	Override, Bit 0 determines the active Vsync

0E 0 Active Vsync Select

This bit is used to select the active Vsync when the override bit is set (Bit 1).

Table 20. Active Vsync Select Settings

Select	Result
0	Vsync input (power-up default)
1	Sync separator output

0F 7 Clamp Input Signal Source

This bit determines the source of clamp timing.

Table 21. Clamp Input Signal Source Settings

Clamp Function	Result
0	Internally generated clamp signal (power-up default)
1	Externally provided clamp signal

A 0 enables the clamp timing circuitry controlled by clamp placement and clamp duration. The clamp position and duration is counted from the leading edge of Hsync.

A 1 enables the external CLAMP input pin. The three channels are clamped when the clamp signal is active. The polarity of clamp is determined by the clamp polarity bit (Register 0x0F, Bit 6).

0F 6 Clamp Input Signal Polarity

This bit determines the polarity of the externally provided clamp signal.

Table 22. Clamp Input Signal Polarity Settings

Clamp Function	Result
1	Active low (power-up default)
0	Active high

Logic 1 means that the circuit clamps when CLAMP is low, and it passes the signal to the ADC when CLAMP is high.

Logic 0 means that the circuit clamps when CLAMP is high, and it passes the signal to the ADC when CLAMP is low.

0F 5 Coast Select

This bit is used to select the active Coast source. The choices are the COAST input pin or Vsync. If Vsync is selected, the additional decision to use the Vsync input pin or the output from the sync separator needs to be made (Register 0x0E, Bits 1, 0).

Table 23. Power-Down Settings

Power-Down	Result
0	COAST input pin
1	Vsync (See the Coast Select section)

0F 4 Coast Input Polarity Override

This register is used to override the internal circuitry that determines the polarity of the Coast signal going into the PLL.

Table 24. Coast Input Polarity Override Settings

Override	Result
0	Determined by chip (power-up default)
1	Determined by user

0F 3 Coast Input Polarity

This bit indicates the polarity of the Coast signal that is applied to the PLL COAST input.

Table 25. Coast Input Polarity Settings

Coast Polarity	Result
0	Active low
1	Active high (power-up default)

Active low means that the clock generator ignores Hsync inputs when Coast is low, and continues operating at the same nominal frequency until Coast goes high.

Active High means that the clock generator ignores Hsync inputs when Coast is high, and continues operating at the same nominal frequency until Coast goes low.

This function needs to be used along with the Coast polarity override bit (Bit 4).

0F 2 Seek Mode Override

This bit is used to either allow or disallow the low power mode. The low power mode (seek mode) occurs when there are no signals on any of the Sync inputs.

Table 26. Seek Mode Override Settings

Override	Result
1	Allow seek mode (power-up default)
0	Disallow seek mode

0F 1 PWRDN

This bit is used to put the chip in full power-down. See the Power Management section for details on which blocks are powered down.

Table 27. Power-Down Settings

Power-Down	Result
0	Power-down
1	Normal operation

10 7-3 Sync-on-Green Slicer Threshold

This register allows the comparator threshold of the sync-on-green slicer to be adjusted. This register adjusts it in steps of 10 mV, with the minimum setting equaling 10 mV (11111) and the maximum setting equaling 330 mV (00000).

The default setting is 23, which corresponds to a threshold value of 100 mV; for a threshold of 150 mV, the setting should be 18.

10 2 Red Clamp Select

This bit determines whether the red channel is clamped to ground or to midscale. For RGB video, all three channels are referenced to ground. For YCbCr (or YUV), the Y channel is referenced to ground, but the CbCr channels are referenced to midscale. Clamping to midscale actually clamps to Pin 37.

Table 28. Red Clamp Select Settings

Clamp	Result
0	Clamp to ground (power-up default)
1	Clamp to midscale (Pin 37)

10 1 Green Clamp Select

This bit determines whether the green channel is clamped to ground or to midscale.

Table 29. Green Clamp Select Settings

Clamp	Result
0	Clamp to ground (power-up default)
1	Clamp to midscale (Pin 37)

10 0 Blue Clamp Select

This bit determines whether the blue channel is clamped to ground or to midscale.

Table 30. Blue Clamp Select Settings

Clamp	Result
0	Clamp to ground (power-up default)
1	Clamp to midscale (Pin 37)

11 7-0 Sync Separator Threshold

This register is used to set the responsiveness of the sync separator. It sets the number of internal 5 MHz clock periods the sync separator must count to before toggling high or low. It works like a low-pass filter to ignore Hsync pulses in order to extract the Vsync signal. This register should be set to some number greater than the maximum Hsync pulse width. The sync separator threshold uses an internal dedicated clock with a frequency of approximately 5 MHz.

The default for this register is 32.

12 7-0 Pre-Coast

This register allows the Coast signal to be applied prior to the Vsync signal. This is necessary in cases where pre-equalization pulses are present. The step size for this control is one Hsync period.

The default is 0.

13 7-0 Post-Coast

This register allows the Coast signal to be applied following the Vsync signal. This is necessary when post-equalization pulses are present. The step size for this control is one Hsync period.

The default is 0.

- 14 7 Hsync Detect**
This bit is used to indicate when activity is detected on the Hsync input pin (Pin 30). If Hsync is held high or low, activity will not be detected.

Table 31. Hsync Detection Results

Detect	Function
0	No activity detected
1	Activity detected

The sync processing block diagram (Figure 14) shows where this function is implemented.

- 14 6 Active Hsync (AHS)**
This bit indicates which Hsync input source is being used by the PLL (Hsync input or sync-on-green). Bit 7 and Bit 1 in this register determine which source is used. If both Hsync and SOG are detected, the user can determine which has priority via Bit 3 in Register 0x0E. The user can override this function via Bit 4 in Register 0x0E. If the override bit is set to Logic 1, then this bit is set to the state of Bit 3 in Register 0x0E.

Table 32. Active Hsync Results

Bit 7 (Hsync Detect)	Bit 1 (SOG Detect)	Bit 4 Reg. 0x0E (Override)	AHS
0	0	0	Bit 3 in 0x0E
0	1	0	1
1	0	0	0
1	1	0	Bit 3 in 0x0E
X	X	1	Bit 3 in 0x0E

AHS = 0 means use the Hsync pin input for Hsync.

AHS = 1 means use the SOG pin input for Hsync.

The override bit is in Register 0x0E, Bit 4.

- 14 5 Detected Hsync Input Polarity Status**
This bit reports the status of the Hsync input polarity detection circuit. It can be used to determine the polarity of the Hsync input. The detection circuit's location is shown in the sync processing block diagram (Figure 14).

Table 33. Detected Hsync Input Polarity Status

Hsync Polarity Status	Result
0	Negative
1	Positive

- 14 4 Vsync Detect**

This bit is used to indicate when activity is detected on the Vsync input pin (Pin 31). If Vsync is held steady high or low, activity is not detected.

Table 34. Vsync Detection Results

Detect	Result
0	No activity detected
1	Activity detected

The sync processing block diagram (Figure 14) shows where this function is implemented.

- 14 3 Active Vsync (AVS)**
This bit indicates which Vsync source is being used, the Vsync input or output from the sync separator. Bit 4 in this register determines which is active. If both Vsync and SOG are detected, the user can determine which has priority via Bit 0 in Register 0x0E. The user can override this function via Bit 1 in Register 0x0E. If the override bit is set to Logic 1, this bit is set to the state of Bit 0 in Register 0x0E.

Table 35. Active Vsync Results

Bit 4, Reg 14H (Vsync Detect)	Bit 1, Reg. 0x0E (Override)	AVS
1	0	0
0	0	1
X	1	Bit 0 in 0x0E

AVS = 0 means Vsync input.

AVS = 1 means Sync separator.

The override bit is in Register 0x0E, Bit 1.

- 14 2 Detected Vsync Output Polarity Status**
This bit reports the status of the Vsync output polarity detection circuit. It can be used to determine the polarity of the Vsync output. The detection circuit's location is shown in the sync processing block diagram (Figure 14).

Table 36. Detected Vsync Output Polarity Status

Vsync Polarity Status	Result
0	Active low
1	Active high

- 14 1 Sync-on-Green Detect**
This bit is used to indicate when sync activity is detected on the sync-on-green input pin (Pin 49).

Table 37. Sync-on-Green Detection Results

Detect	Result
0	No activity detected
1	Activity detected

The sync processing block diagram (Figure 14) shows where this function is implemented.

- 14 0 Detected Coast Polarity Status**
This bit reports the status of the Coast input polarity detection circuit. It can be used to determine the polarity of the Coast input. The detection circuit's location is shown in the sync processing block diagram (Figure 14).

Table 38. Detected Coast Input Polarity Status

Polarity Status	Result
0	Coast polarity negative
1	Coast polarity positive

This indicates that Bit 1 of Register 5 is the 4:2:2 output mode select bit.

15 1 4:2:2 Output Mode Select

A bit that configures the output data in 4:2:2 mode. This mode can be used to reduce the number of data lines used from 24 down to 16 for applications using YUV, YCbCr, or YPbPr graphics signals. A timing diagram for this mode is shown in Figure 11.

Recommended input and output configurations are shown in Table 39 and Table 40.

Table 39. 4:2:2 Output Mode Select

Select	Output Mode
0	4:2:2
1	4:4:4

Table 40. 4:2:2 Input/Output Configuration

Channel	Input Connection	Output Format
Red	V	U/V
Green	Y	Y
Blue	U	High impedance

16 7 Extra PLL Divider

A bit that can add an additional divide-by-2 into the PLL divide ratio. Enabling this function at pixel frequencies below 20 MHz can result in improved PLL jitter performance, as it allows the VCO to run at a higher frequency, resulting in lower jitter.

Table 41. PLL VCO Divide

Select	PLL Divider
0	Off
1	Extra divide-by-2

16 6-5 SOGIN Bandwidth

Two bits that can control the bandwidth of the sync-on-green input (SOGIN). In most applications, the SOGIN bandwidth should be set to its maximum (300 MHz). When there is excessive noise on SOGIN, reducing the bandwidth can help suppress the noise.

Table 42. SOGIN Bandwidth

Select	Pulses Filtered
00	300 MHz
01 or 10	13 MHz
11	6.5 MHz

16 4 Analog Input Bandwidth

This bit controls the bandwidth of the red, green, and blue analog inputs. In most applications, the analog input bandwidth should be set to its maximum (300 MHz). When there is excessive noise on the analog inputs, reducing the bandwidth can help suppress the noise.

Table 43. Anti-Aliasing Filter

Select	Input Bandwidth
0	300 MHz
1	7 MHz

19 7:0 Red Target Code

This specifies the targeted value of the final offset for the red channel when auto-offset is used (Register 0x1D, Bit 7 = 1). Default is 4.

1A 7:0 Green Target Code

This specifies the targeted value of the final offset for the green channel when auto-offset is used (Register 0x1D Bit 7 = 1). Default is 4.

1B 7:0 Blue Target Code

This specifies the targeted value of the final offset for the blue channel when auto-offset is used (Register 0x1D, Bit 7 = 1). Default is 4.

1D 7 Auto-Offset Enable

Enables the auto-offset circuitry. Default is 0.

1D 6 Hold Auto-Offset

Holds the offset output of the auto-offset at the current value. Default is 0.

1D 1:0 Update Mode

Changes the update rate of the auto-offset. Default is 10.

Table 44. Auto-Offset Update Rate

Update Mode	Auto-Offset Update Timing
00	Every clamp cycle
01	Every 16 clamp cycles
10	Every 64 clamp cycles

2-WIRE SERIAL CONTROL PORT

A 2-wire serial interface control interface is provided. Two AD9985A devices can be connected to the 2-wire serial interface; each device has a unique address.

The 2-wire serial interface comprises a clock (SCL) and a bidirectional data (SDA) pin. The analog flat panel interface acts as a slave for receiving and transmitting data over the serial interface. When the serial interface is not active, the logic levels on SCL and SDA are pulled high by external pull-up resistors.

Data received or transmitted on the SDA line must be stable for the duration of the positive-going SCL pulse. Data on SDA must change only when SCL is low. If SDA changes state while SCL is high, the serial interface interprets that action as a start or stop sequence.

The components to serial bus operation are

- Start signal
- Slave address byte
- Base register address byte
- Data byte to read or write
- Stop signal

When the serial interface is inactive (SCL and SDA are high), communications are initiated by sending a start signal. The start signal is a high-to-low transition on SDA while SCL is high. This signal alerts all slave devices that a data transfer sequence is coming.

The first eight bits of data transferred after a start signal comprise a 7-bit slave address (the first seven bits) and a single R/W bit (the eighth bit). The R/W bit indicates the direction of data transfer, read from (1) or write to (0) the slave device. If the transmitted slave address matches the address of the device (set by the state of the SA1-0 input pins in Table 45), the AD9985A acknowledges by bringing SDA low on the ninth SCL pulse. If the addresses do not match, the AD9985A does not acknowledge.

Table 45. Serial Port Addresses

Bit 7 A ₆ (MSB)	Bit 6 A ₅	Bit 5 A ₄	Bit 4 A ₃	Bit 3 A ₂	Bit 2 A ₁	Bit 1 A ₀
1	0	0	1	1	0	0
1	0	0	1	1	0	1

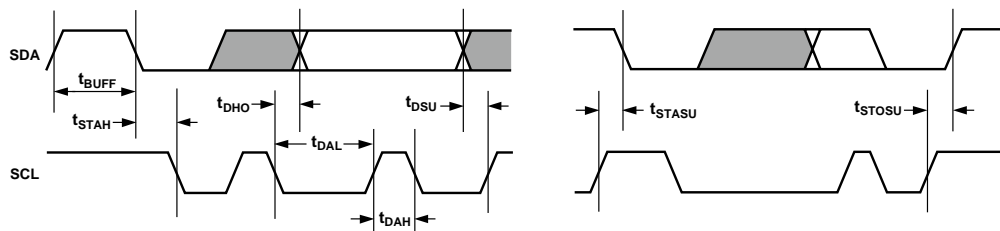

Figure 12. Serial Port Read/Write Timing

DATA TRANSFER VIA SERIAL INTERFACE

For each byte of data read or written, the MSB is the first bit of the sequence.

If the AD9985A does not acknowledge the master device during a write sequence, the SDA remains high so the master can generate a stop signal. If the master device does not acknowledge the AD9985A during a read sequence, the AD9985A interprets this as end-of-data. The SDA remains high so the master can generate a stop signal.

Writing data to specific control registers of the AD9985A requires that the 8-bit address of the control register of interest be written after the slave address has been established. This control register address is the base address for subsequent write operations. The base address auto-increments by one for each byte of data written after the data byte intended for the base address.

Data is read from the control registers of the AD9985A in a similar manner. Reading requires two data transfer operations:

The base address must be written with the R/W bit of the slave address byte low to set up a sequential read operation.

Reading (the R/W bit of the slave address byte high) begins at the previously established base address. The address of the read register auto-increments after each byte is transferred.

To terminate a read/write sequence to the AD9985A, a stop signal must be sent. A stop signal comprises a low-to-high transition of SDA while SCL is high.

A repeated start signal occurs when the master device driving the serial interface generates a start signal without first generating a stop signal to terminate the current communication. This is used to change the mode of communication (read, write) between the slave and master without releasing the serial interface lines.

Serial Interface Read/Write Examples

Write to one control register:

1. Start signal
2. Slave address byte (R/ \overline{W} Bit = low)
3. Base address byte
4. Data byte to base address
5. Stop signal

Write to four consecutive control registers:

1. Start signal
2. Slave address byte (R/ \overline{W} bit = low)
3. Base address byte
4. Data byte to base address
5. Data byte to (base address + 1)
6. Data byte to (base address + 2)
7. Data byte to (base address + 3)
8. Stop signal

Read from one control register:

1. Start signal
2. Slave address byte (R/ \overline{W} bit = low)
3. Base address byte
4. Start signal
5. Slave address byte (R/ \overline{W} bit = high)
6. Data byte from base address
7. Stop signal

Read from four consecutive control registers:

1. Start signal
2. Slave address byte (R/ \overline{W} bit = low)
3. Base address byte
4. Start signal
5. Slave address byte (R/ \overline{W} Bit = high)
6. Data byte from base address
7. Data byte from (base address + 1)
8. Data byte from (base Address + 2)
9. Data byte from (base Address + 3)
10. Stop signal



Figure 13. Serial Interface—Typical Byte Transfer

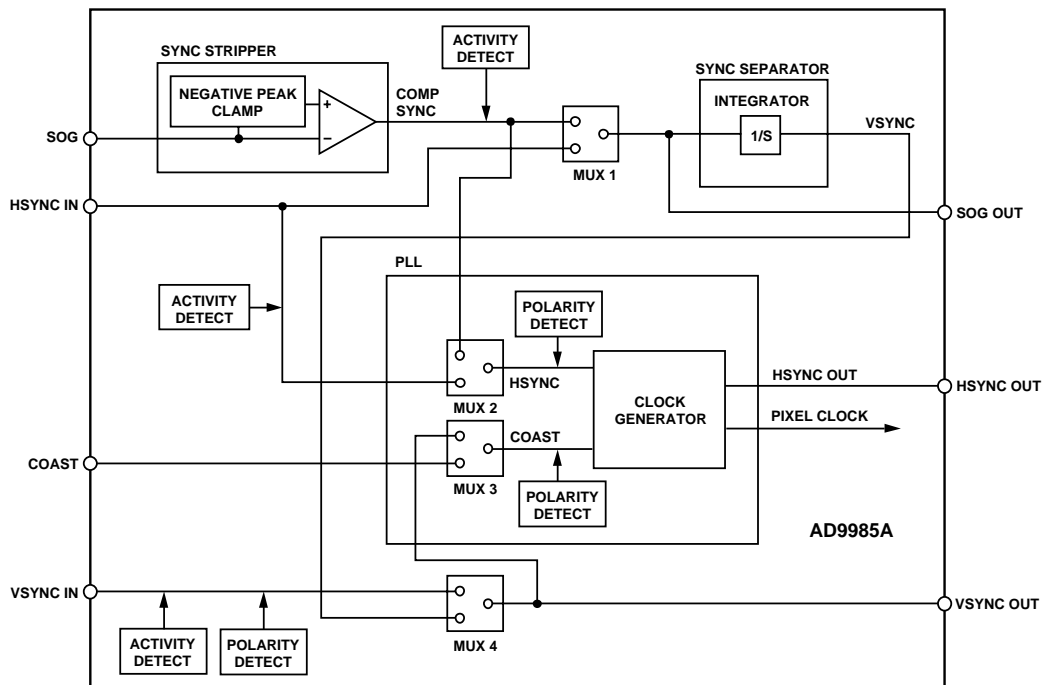

Figure 14. Sync Processing Block Diagram

Table 46. Control of the Sync Block Muxes via the Serial Register

Mux No.	Serial Bus Control Bit	Control Bit State	Result
1 and 2	0x0E: Bit 3	0	Pass Hsync
		1	Pass sync-on-green
3	0x0F: Bit 5	0	Pass Coast
		1	Pass Vsync
4	0x0E: Bit 0	0	Pass Vsync
		1	Pass sync separator signal

SYNC SLICER

The purpose of the sync slicer is to extract the sync signal from the green graphics channel. A sync signal is not present on all graphics systems, only those with sync-on-green. The sync signal is extracted from the green channel in a two-step process. First, the SOG input is clamped to its negative peak (typically, 0.3 V below the black level). Next, the signal goes to a comparator with a variable trigger level, nominally 0.15 V above the clamped level. The sliced sync is typically a composite sync signal containing both Hsync and Vsync.

SYNC SEPARATOR

A sync separator extracts the Vsync signal from a composite sync signal. It does this through a low-pass filter-like or integrator-like operation. It works on the idea that the Vsync signal stays active for a much longer time than the Hsync signal, so it rejects any signal shorter than a threshold value, which is somewhere between an Hsync pulse width and a Vsync pulse width.

The sync separator on the AD9985A is simply an 8-bit digital counter with a 5 MHz clock. It works independently of the polarity of the composite sync signal. (Polarities are determined elsewhere on the chip.) The basic idea is that the counter counts up when Hsync pulses are present. But since Hsync pulses are relatively short in width, the counter only reaches a value of N before the pulse ends. It then starts counting down, eventually reaching 0 before the next Hsync pulse arrives.

The specific value of N varies for different video modes, but is always less than 255. For example, with a 1 μ s width Hsync, the counter only reaches 5 ($1 \mu\text{s}/200 \text{ ns} = 5$). Now, when Vsync is present on the composite sync, the counter also counts up. However, since the Vsync signal is much longer, it counts to a higher number M. For most video modes, M is at least 255. So, Vsync can be detected on the composite sync signal by detecting when the counter counts to a value higher than N. The specific count that triggers detection (T) can be programmed through the serial register (0x11).

Once Vsync has been detected, there is a similar process to detect when it goes inactive. At detection, the counter first resets to 0, then starts counting up when Vsync goes away. Similar to the previous case, it detects the absence of Vsync when the counter reaches the threshold count (T). In this way, it rejects noise and/or serration pulses. Once Vsync is detected to be absent, the counter resets to 0 and begins the cycle again.

PCB LAYOUT RECOMMENDATIONS

The AD9985A is a high precision, high speed analog device. Consequently, to get the maximum performance out of the part, it is important to have a board with a good layout. This section provides guidelines for designing a board using the AD9985A.

ANALOG INTERFACE INPUTS

Using the following layout techniques on the graphics inputs is extremely important.

Minimize the trace length running into the graphics inputs. This is accomplished by placing the AD9985A as close as possible to the graphics VGA connector. Long input trace lengths are undesirable because they pick up more noise from the board and other external sources.

Place the 75 Ω termination resistors (see Figure 1) as close as possible to the AD9985A chip. Any additional trace length between the termination resistors and the input of the AD9985A increases the magnitude of reflections, which corrupts the graphics signal.

Use 75 Ω matched impedance traces. Trace impedances other than 75 Ω also increase the chance of reflections.

The AD9985A has very high input bandwidth (500 MHz). While this is desirable for acquiring a high resolution PC graphics signal with fast edges, it means that it also captures any high frequency noise present. Therefore, it is important to reduce the amount of noise that is coupled to the inputs. Avoid running any digital traces near the analog inputs.

Due to the high bandwidth of the AD9985A, low-pass filtering the analog inputs can sometimes help to reduce noise. (For many applications, filtering is unnecessary.) Experiments have shown that placing a series ferrite bead prior to the 75 Ω termination resistor is helpful in filtering out excess noise. Specifically, the part used was the #2508051217Z0 from Fair-Rite, but each application can work best with a different bead value. Alternately, placing a 100 Ω to 120 Ω resistor between the 75 Ω termination resistor and the input coupling capacitor can also be beneficial.

POWER SUPPLY BYPASSING

It is recommended to bypass each power supply pin with a 0.1 μF capacitor. The exception is when two or more supply pins are adjacent to each other. For these groupings of powers/grounds, it is necessary to have only one bypass capacitor. The fundamental idea is to have a bypass capacitor within about 0.5 cm of each power pin. Also, avoid placing the capacitor on the opposite side of the PC board from the AD9985A, as that interposes resistive vias in the path.

The bypass capacitors should be physically located between the power plane and the power pin. Current should flow from the power plane to the capacitor to the power pin. Do not make the power connection between the capacitor and the power pin. Placing a via underneath the capacitor pads, down to the power plane, is generally the best approach.

It is particularly important to maintain low noise and good stability of PV_{D} (the clock generator supply). Abrupt changes in PV_{D} can result in similarly abrupt changes in sampling clock phase and frequency. This can be avoided by careful attention to regulation, filtering, and bypassing. It is highly desirable to provide separate regulated supplies for each of the analog circuitry groups (V_{D} and PV_{D}).

Some graphic controllers use substantially different levels of power when active (during active picture time) and when idle (during horizontal and vertical sync periods). This can result in a measurable change in the voltage supplied to the analog supply regulator, which can, in turn, produce changes in the regulated analog supply voltage. This can be mitigated by regulating the analog supply, or at least PV_{D} , from a different, cleaner power source (for example, from a 12 V supply).

It is recommended to use a single ground plane for the entire board. Experience has repeatedly shown that the noise performance is the same or better with a single ground plane. Using multiple ground planes can be detrimental because each separate ground plane is smaller, and long ground loops can result.

When using separate ground planes is unavoidable, it is recommended to minimally place a single ground plane under the AD9985A. The location of the split should be at the receiver of the digital outputs. For this case, it is even more important to place components wisely because the current loops are much longer (current takes the path of least resistance). Figure 15 shows an example of a current loop.

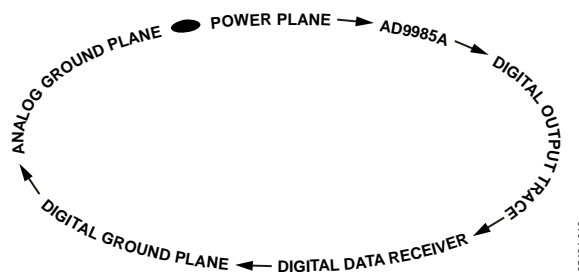

Figure 15. Current Loop

PLL

Place the PLL loop filter components as close to the FILT pin as possible.

Do not place any digital or other high frequency traces near these components.

Use the values suggested in the data sheet with 10% tolerances or less.

OUTPUTS (BOTH DATA AND CLOCKS)

Try to minimize the trace length that the digital outputs have to drive. Longer traces have higher capacitance, which requires more current, which causes more internal digital noise. Shorter traces reduce the possibility of reflections.

Adding a series resistor of value $22\ \Omega$ to $100\ \Omega$ can suppress reflections, reduce EMI, and reduce the current spikes inside of the AD9985A. However, if $50\ \Omega$ traces are used on the PCB, the data outputs should not need resistors. A $22\ \Omega$ resistor on the DATAACK output should provide good impedance matching that reduces reflections. If series resistors are used, place them as close as possible to the AD9985A pins (but try not to add vias or extra length to the output trace in order to get the resistors closer).

If possible, limit the capacitance that each of the digital outputs drives to less than $10\ \text{pF}$. This can easily be accomplished by keeping traces short and by connecting the outputs to only one device. Loading the outputs with excessive capacitance increases the current transients inside of the AD9985A, creating more digital noise on its power supplies.

DIGITAL INPUTS

The digital inputs on the AD9985A were designed to work with $3.3\ \text{V}$ signals, but are tolerant of $5.0\ \text{V}$ signals. Therefore, no extra components need to be added if using $5.0\ \text{V}$ logic.

Any noise that gets onto the Hsync input trace adds jitter to the system. Therefore, minimize the trace length and do not run any digital or other high frequency traces near it.

VOLTAGE REFERENCE

Bypass the voltage reference with a $0.1\ \mu\text{F}$ capacitor. Place it as close as possible to the AD9985A pin. Make the ground connection as short as possible.

OUTLINE DIMENSIONS

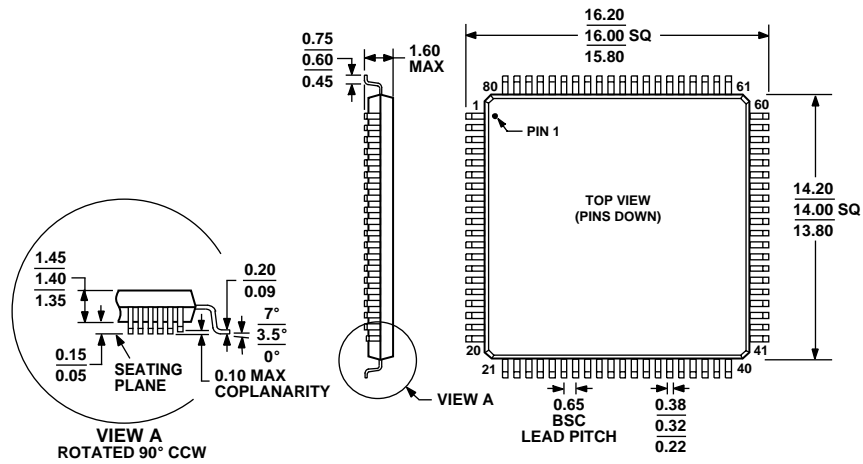

COMPLIANT TO JEDEC STANDARDS MS-026-BEC

Figure 16. 80-Lead Low Profile Quad Flat Package [LQFP] (ST-80-2)
Dimensions shown in millimeters

ORDERING GUIDE

Model	Temperature Range	Package Description	Package Option
AD9985ABSTZ-110 ¹	-40°C to +85°C	80-lead LQFP	ST-80-2
AD9985AKSTZ-110 ¹	0°C to 70°C	80-lead LQFP	ST-80-2
AD9985AKSTZ-140 ¹	0°C to 70°C	80-lead LQFP	ST-80-2
AD9985A/PCB		Evaluation Board	

¹ Z = Pb-free part.

AD9985A

NOTES