

Design Guide



Introduction

The Universal Serial Bus (USB) is an industry standard serial interface between a computer and peripherals such as a mouse, joystick, keyboard, etc. This design guide describes how a cost-effective USB optical mouse can be built using the Avago Technologies ADNS-5700-XXXX optical sensor. The document starts with the basic operations of a computer mouse peripheral followed by an introduction to the Avago Technologies ADNS-5700-XXXX Optical Navigation Sensor. A schematic of the ADNS-5700-XXXX optical sensor and buttons of a standard mouse can be found in Appendix A. The ADNS-5700-XXXX data sheet is available from the Avago Technologies web site at www.avagotech.com. USB documentation can be found at the USB Implementers Forum web site at www.usb.org.

The ADNS-5700 sensor along with the ADNS-5100 round lens, ADNS-5100-001 trim lens or ADNS-5100-002 truncated round lens, ADNS-5200 clip and HLMP-ED80-XX000 LED form a complete and compact mouse

tracking system. There are no moving parts, which means high reliability and less maintenance for the end user. In addition, precision optical alignment is not required, facilitating high volume assembly.

Optical Mouse Basics

The optical mouse measures changes in position by optically acquiring sequential surface images (frames), and mathematically determining the direction and magnitude of movement. The Z-wheel movement is done in the traditional method by decoding the quadrature signal generated by optical sensors. This design guide shows how to connect to and manage a standard configuration of mouse hardware, as well as handle the USB protocols as a standard way of reporting mouse movement and button presses to the PC.

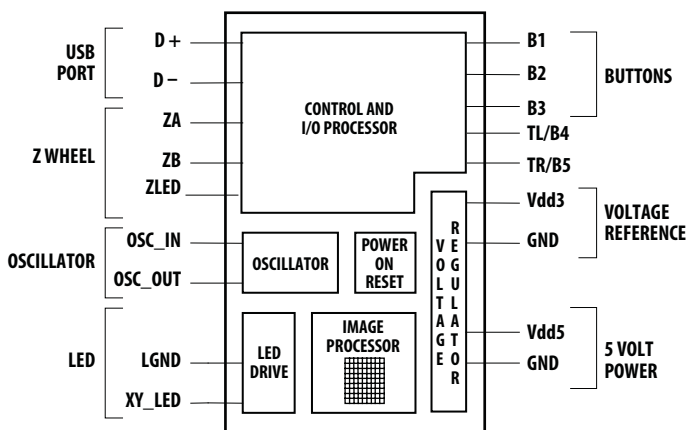

Figure 1. ADNS-5700-XXXX 3 button Optical Mouse Hardware Block Diagram

Optical Sensor

Avago Technologies's ADNS-5700-XXXX optical sensor is used in this reference design as the primary navigation engine. This Optical Navigation Technology contains an Image Acquisition System, a Digital Signal Processor and USB stream output.

The IAS acquires microscopic surface images via the lens and illumination system provided by the ADNS-5100 round lens, ADNS-5100-001 trim lens or ADNS-5100-002 truncated lens, ADNS-5200 clip and HLMP-ED80-XX00 LED. These images are processed by the DSP to determine the direction and distance of motion. The DSP generates the Δx and Δy relative displacement values which are converted to USB motion data.

Mouse Optics

The motion of Z-wheel is detected using the traditional method by decoding the quadrature signal generated by optical sensors.

For mechanical Z-wheels the following must be implemented.

1. Use a rotary switch equivalent to the Panasonic part EVQVX at <http://industrial.panasonic.com/www-data/pdf/ATC0000/ATC0000CE20.pdf> (The key point is stable "A" switch state in all detent positions).
2. Solder the rotary switch into the PCB such that the common pin is closest to the cable end of the mouse. (Metal plate faces to left)
3. Connect the "A" terminal of the rotary switch to "ZA" and the "B" terminal to "ZB". ZA MUST be connected to "Signal A" in Figure 20 where the z-wheel detents are mechanically stable.

As shown in Figure 2 below, traveling along the quadrature signal to the right produces a unique set of state transitions, and traveling to the left produces another set of unique state transitions.

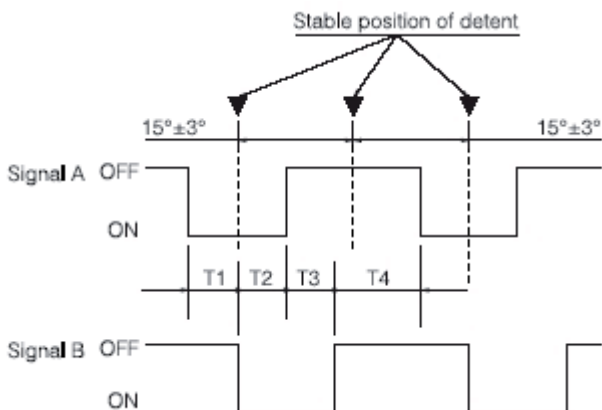

Figure 2. Optics Quadrature Signal Generation

Mouse Buttons

Mouse buttons are connected as standard switches. These switches are pulled up by the pull up resistors inside the sensor. When the user presses a button, the switch will be closed and the pin will be pulled LOW to GND. A LOW state at the pin is interpreted as the button being pressed. A HIGH state is interpreted as the button has been released or the button is not being pressed. Normally the switches are debounced in firmware for 9-17ms. In this reference design there are three switches: left, Z-wheel and right.

Some details on ADNK-5703

The ADNK-5703 reference design mouse unit allows users to evaluate the performance of the Optical Tracking Engine (sensor, lens, Led assembly clip, Led) over a USB protocol. The optical mouse uses the ADNS-5700-H4MB. This kit also enables users to understand the recommended mechanical assembly. (See Appendix C and D)

System Requirements

PCs using Windows® 2003/ Windows® XP/ Windows® Vista with standard 3-button USB mouse driver loaded.

Functionality

3-button, mechanical scroll wheel mouse.

Operating (For USB Mode)

Hot pluggable with USB port. The PC does not need to be powered off when plugging or unplugging the evaluation mouse.

To Disassemble the ADNK-5703 Unit

The ADNK-5703 comprises of the plastic mouse casing, printed circuit board (PCB), lens, buttons, and USB cable. (See Figure 3) Unscrewing the one screw located at the base of the unit can open the ADNK-5703 unit. Lifting and pulling the PCB out of the base plate can further disassemble the mouse unit.

Caution: The lens is not permanently attached to the sensor and will drop out of the assembly.

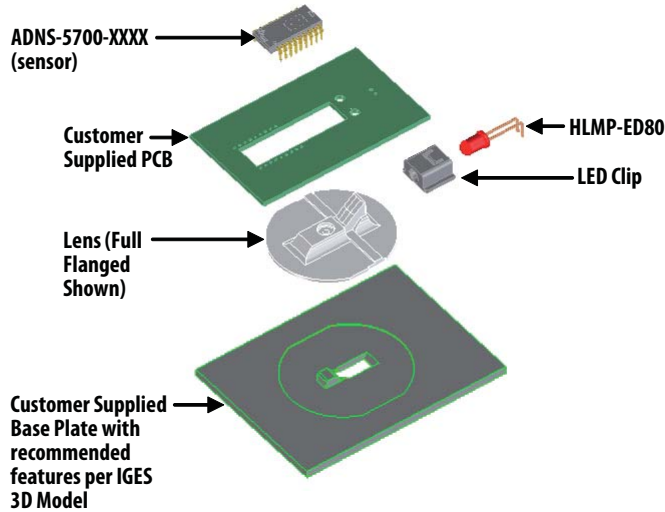

Figure 3. Exploded view drawing of optical tracking engine with ADNS-5700-XXXX optical mouse sensor.

While reassembling the components, please make sure that the Z height (Distance from lens reference plane to surface) is valid. The Z-height is from 2.3 to 2.5mm with a nominal of 2.4mm. Refer to Figure 4.

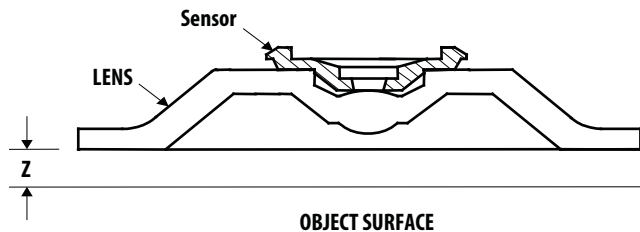

Figure 4. Distance from lens reference plane to surface

Regulatory Requirements

- Passes FCC B and worldwide analogous emission limits when assembled into a mouse with unshielded cable and following Avago Technologies recommendations.
- Passes EN61000-4-4/IEC801-4EFT tests when assembled into a mouse with shielded cable and following Avago Technologies recommendations.
- UL flammability level UL94 V-0.
- Provides sufficient ESD creepage/clearance distance to avoid discharge up to 15kV when assembled with round lens into a mouse according to usage instructions above.

Sensor

The sensor technical information is contained in the ADNS-5700-XXXX Data Sheet.

Lens

The lens technical information is contained in the ADNS-5100 Data Sheet. The flange on the standard ADNS-5100 lens is for ESD protection.

LED Assembly Clip

The information on the assembly clip is contained in the ADNS-5200 Data Sheet.

LED

The LED technical information is contained in the HLMP-ED80-XX000 Data.

Base Plate Feature – 3D Model IGES Files

The IGES file on the CD-ROM provides recommended base plate molding features to ensure optical alignment. This includes PCB assembly diagrams like solder fixture in assembly and exploded view, as well as solder plate. See Appendix D for details.

Reference Design Documentation – Gerber File

The Gerber File presents detailed schematics used in ADNK-5703 in PCB layout form. See Appendix C for more details.

Overall circuit

A schematic of the overall circuit is shown in Appendix A of this document. Appendix B lists the bill of materials.

USB Interface

All USB Human Interface Device (HID) class applications follow the same USB start-up procedure. The procedure is as follows

1. Device Plug-in

When a USB device is first connected to the bus, it is powered and running firmware, but communications on the USB remain non-functional until the host has issued a USB bus reset.

2. Bus Reset

The pull-up resistor on D- notifies the hub that a device has just been connected. The host recognizes the presence of a new USB device and initiates a bus reset to that device.

3. Enumeration

The host initiates SETUP transactions that reveal general and device specific information about the mouse. When the description is received, the host assigns a new and unique USB address to the mouse. The mouse begins responding to communication with the newly assigned address, while the host continues to ask for information about the device description, configuration description and HID report description. Using the information returned from the mouse, the host now knows the number of data endpoints supported by the mouse (2). At this point, the process of enumeration is completed.

USB Jumper Table

Below is the USB jumper table for ADNS-5700-XXXX sensor for both 3 button and 5 button USB mouse. Both mouse type will have different VID and PID strings. Also note the connections for OPT0 and OPT1.

Part Number	Description	Resolution (dpi)	Buttons	Tilt Wheel	Z-Wheel	Sensor Position	VID	PID	Mfg String	Product String
ADNS-5700-H3MB	Standard 3 buttons	1000	3	No	Mechanical	0°	0x192F	0x0416	Null	USB Optical Mouse
ADNS-5700-H3PB	Standard 3 buttons	1000	3	No	Optical	0°	0x192F	0x0416	Null	USB Optical Mouse
ADNS-5700-H4MB	Standard 3 buttons	1000	3	TW	Mechanical	0°	0x192F	0x0416	Null	USB Optical Mouse
ADNS-5700-H4PB	Standard 3 buttons	1000	3	TW	Optical	0°	0x192F	0x0416	Null	USB Optical Mouse
ADNS-5700-H5MD	Standard 5 buttons	1000	5	No	Mechanical	0°	0x192F	0x0616	Null	USB Optical Mouse
ADNS-5700-H5PD	Standard 5 buttons	1000	5	No	Optical	0°	0x192F	0x0616	Null	USB Optical Mouse
ADNS-5700-H3NB	Standard 3 buttons	1000	3	No	Mechanical	270°	0x192F	0x0416	Null	USB Optical Mouse
ADNS-5700-H3QB	Standard 3 buttons	1000	3	No	Optical	270°	0x192F	0x0416	Null	USB Optical Mouse
ADNS-5700-H4NB	Standard 3 buttons	1000	3	TW	Mechanical	270°	0x192F	0x0416	Null	USB Optical Mouse
ADNS-5700-H4QB	Standard 3 buttons	1000	3	TW	Optical	270°	0x192F	0x0416	Null	USB Optical Mouse
ADNS-5700-H5ND	Standard 5 buttons	1000	5	No	Mechanical	270°	0x192F	0x0616	Null	USB Optical Mouse
ADNS-5700-H5QD	Standard 5 buttons	1000	5	No	Optical	270°	0x192F	0x0616	Null	USB Optical Mouse

Appendix A: Schematic Diagram of the Overall Circuit

A1 Schematic for main board circuit using Avago Technologies ADNS-5700-H4MB optical mouse

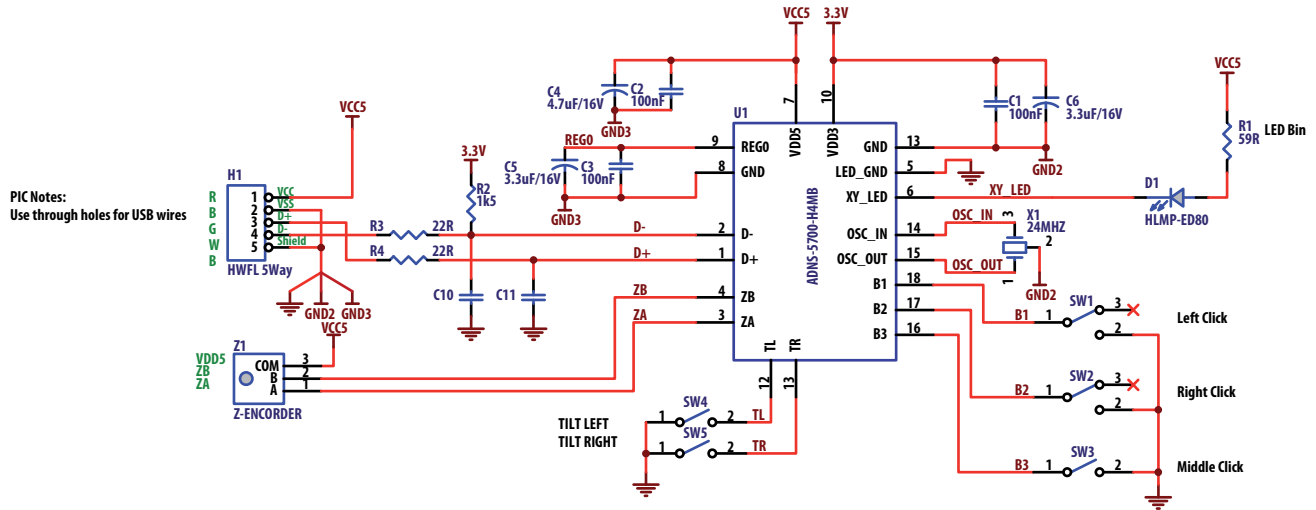

A2 Button schematic and connection diagram

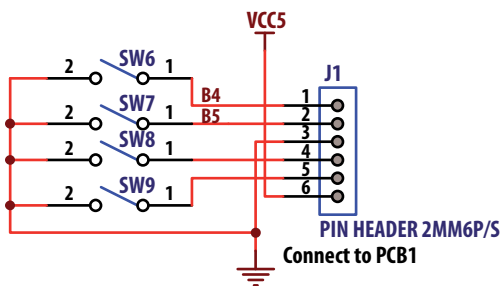

A3 Z-encoder schematic and connection diagram

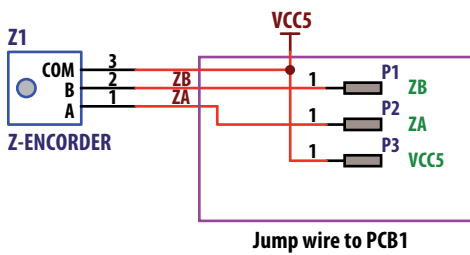

Appendix B: Bill of Materials for Components Shown on schematic

Main Board

No	Description	Value	Qty	Designator
1	Resistor	22R 1%	2	R3.R4
2	Resistor	59R 1%	1	R1
3	Resistor	1k5 1%	1	R2
4	Capacitor Ceramic	100nF	3	C1.C2.C3
5	Capacitor Electrolytic	3.3uF, 16V	2	
6	Capacitor Electrolytic	4.7uF, 16V	1	
7	Capacitor Tantalum	10uF, 10V	2	C15.C16
8	IC Sensor	A5700	1	
9	Crystal - tCSALS24M0X53-B0	24Mhz	1	
10	Connector – PCB Socket Straight	6 Way, S. Row	1	
11	Cable – USB	1 meter	1	
12	Jumper Wire			
13	LED Clip	ADNS-5200	1	
14	Sensor LED	HLMP-E80	1	
15	Switch – Micro OMRON	3 Way	2	
16	Switch – Push Button	–	2	

Button Board

No	Description	Color / Value	Qty	Designator
1	Connector – Pin Header Straight	6 Way S.Row	1	J1
2	Swtich – Push Button	–	2	SW6.SW7
3	Switch – Push Button Tactile	–	2	SW8.SW9

Z Encoder Board

No	Description	Color / Value	Qty	Designator
1	Z Encoder	3 Way	1	Z1

Appendix D: Kit Components

The designer's kit contains components as follows:

Part Number	Description	Name	Quantity
ADNK-5703	Reference Design Mouse	Reference Design Unit	1
ADNS-5700-XXXX	Optical Mouse Sensor	Sensor	5
ADNS-5100	Round Lens Plate	Lens	5
ADNS-5100-001	Trim Lens Plate	Lens	5
ADNS-5100-002	Truncated Round Lens Plate	Lens	5
ADNS-5200	LED Assembly Clip	LED Clip	5
HLMP-ED80-XX000	LED	LED	5
ADNK-5703 CD	Includes Documentation and Support Files for ADNK-5703 Documentation a. ADNS-5700-XXXX Optical Mouse Data Sheet b. ADNS-5100 Round Lens Data Sheet/ADNS-5100-001 Trim Lens Data c. ADNS-5100-001 Truncated Round Lens Data Sheet d. ADNS-5200 LED Assembly Clip Data Sheet e. HLMP-ED80-XX000 LED Data Sheet Hardware Support Files ADNK-5703 BOM List b. ADNK-5703 Schematic c. 3D Model IGES Files d. Gerber File		1

For product information and a complete list of distributors, please go to our web site: www.avagotech.com

Avago, Avago Technologies, and the A logo are trademarks of Avago Technologies in the United States and other countries.
Data subject to change. Copyright © 2005-2010 Avago Technologies. All rights reserved.
AV02-1738EN - June 8, 2010

