

PART NUMBER: VBT2-SMT series

DESCRIPTION: dc-dc converter

description

Designed to convert fixed voltages into an isolated voltage, the VBT2-SMT series is well suited for providing board-mount local supplies in a wide range of applications, including mixed analog/digital circuits, test & measurement equip., process/machine controls, datacom/telecom fields, etc...

The semi-regulated output can be followed by 3-terminal regulators to provide output protection, in addition to output regulation.

features

- isolated 2 W output
- temperature range: -40°C~+85°C
- unregulated
- high efficiency to 85%
- single voltage output
- small footprint
- SMD package style
- industry standard pinout
- UL94-V0 package
- no heatsink required
- 1K Vdc isolation
- high power density
- no external component required
- low cost

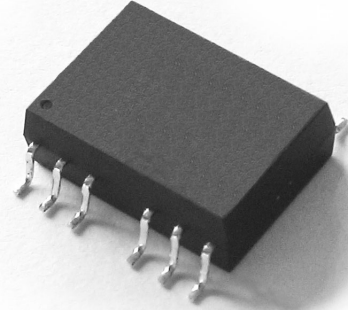

model number	input voltage		output voltage	output current		efficiency
	nominal	range		max.	min.	
VBT2-S5-S5-SMT	5 Vdc	4.5~5.5 Vdc	5 Vdc	400 mA	40 mA	80%
VBT2-S5-S9-SMT	5 Vdc	4.5~5.5 Vdc	9 Vdc	222 mA	23 mA	82%
VBT2-S5-S12-SMT	5 Vdc	4.5~5.5 Vdc	12 Vdc	167 mA	17 mA	84%
VBT2-S5-S15-SMT	5 Vdc	4.5~5.5 Vdc	15 Vdc	133 mA	14 mA	84%
VBT2-S12-S5-SMT	12 Vdc	10.8~13.2 Vdc	5 Vdc	400 mA	40 mA	82%
VBT2-S12-S9-SMT	12 Vdc	10.8~13.2 Vdc	9 Vdc	222 mA	23 mA	83%
VBT2-S12-S12-SMT	12 Vdc	10.8~13.2 Vdc	12 Vdc	167 mA	17 mA	85%
VBT2-S12-S15-SMT	12 Vdc	10.8~13.2 Vdc	15 Vdc	133 mA	14 mA	85%

OUTPUT SPECIFICATIONS

item	test conditions	min.	typ.	max.	units
output power		0.2		2	W
line regulation	for Vin change of 1%			±1.2	%
load regulation	10% to 100% full load (5 output)		12.8	15	%
	10% to 100% full load (9 output)		8.3	15	%
	10% to 100% full load (12 output)		6.8	15	%
	10% to 100% full load (15 output)		6.3	15	%
output voltage accuracy	see tolerance envelope graph				
temperature drift	@ 100% load			0.03	%/°C
output ripple	20 MHz bandwidth		75	150	mVp-p
switching frequency	full load, nominal input		70		KHz

NOTE:

1. All specifications measured at TA=25°C, humidity <75%, nominal input voltage and rated output load unless otherwise specified.

PART NUMBER: VBT2-SMT series

DESCRIPTION: dc-dc converter

GENERAL SPECIFICATIONS

short circuit protection	<1 second
temperature rise at full load	25°C max, 15°C typ.
cooling	free air convection
operating temperature range	-40°C to +85°C
storage temperature range	-55°C to +125°C
soldering temperature	260°C (1.5mm from case for 10 sec.)
storage humidity range	<95%
case material	plastic (UL94-V0)
MTBF	>3,500,000 hrs.

ISOLATION SPECIFICATIONS

item	test conditions	min.	typ.	max.	units
isolation voltage	tested for 1 min.	1000			Vdc
insulation resistance	test at 500 Vdc	1000			M Ω

DIMENSIONS (mm)

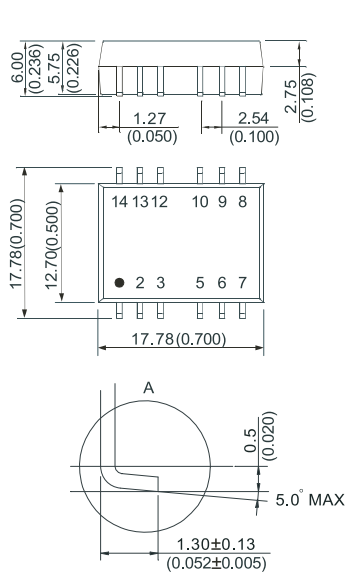

Note:
 Unit:mm(inch)
 Pin section:0.60*0.25mm(0.024*0.010inch)
 Pin tolerances:±0.10mm(±0.004inch)
 General tolerances:±0.25mm(±0.010inch)

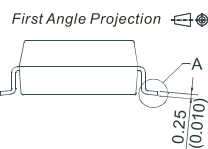

RECOMMENDED FOOTPRINT
 Bottom view,grid:2.54mm(0.1inch)

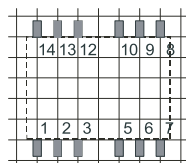

FOOTPRINT DETAILS

Pin	Singles
1	GND
2	Vin
5	NC
6	0V
7	+Vo
10	NC
Others	NC

NC:No Connection

TYPICAL CHARACTERISTICS

Tolerance Envelope Graph

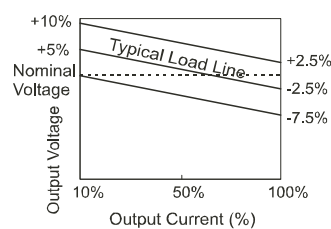

Temperature Derating Graph

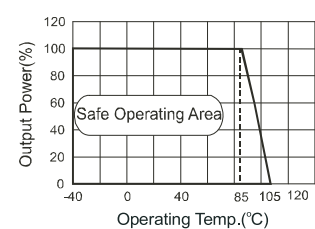

PART NUMBER: VBT2-SMT series

DESCRIPTION: dc-dc converter

APPLICATION NOTES:

- Input filtering

To reduce the reflected ripple current and minimize EMI, especially when the converter input is more than 2" away from the DC source, it is recommended to connect a low ESR electrolytic capacitor between Vin and Gnd. The values suggested are as shown in Table 1. If additional filtering is required, the capacitance may be increased, or expanded to an LC network as shown in Figure 1.

TABLE 1

Vin (V dc)	Cin (μF)	Vout (V dc)	Cout (μF)
5	4.7	5	10
12	2.2	9	4.7
-	-	12	2.2
-	-	15	1

not recommend to connect any external capacitor in application field with less than 0.5 watt output.

- Output filtering

Output capacitance may be increased for additional filtering, but should not exceed 10μF or expanded to an LC network as in Figure 1.

FIGURE 1

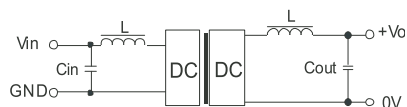

RECOMMENDED REFLOW SOLDERING PROFILE

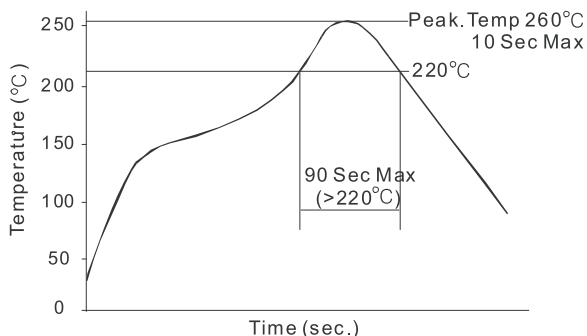

FIGURE 2



- Minimum loading

The converter needs a minimum of 10% loading to maintain output regulation. Operation under no-load conditions will not cause immediate damages but may reduce reliability, and cause performance not to meet specifications.

- Regulation

With a semi-regulated design, the converter's output voltage varies with load current and will change proportionally to the input voltage. If regulated output is needed, an external regulator can be used as shown in Figure 2.

- Protection

The converter has minimal protection against input over-voltage or output over-load, and may be permanently damaged if exposed to these conditions. An input clamping device can be used for input voltage limiting. An input fuse or an output fuse also be used to protect against over-loading.

- Dual outputs used as a single output

The +Vout and -Vout can be used to obtain a single output that is the sum of the two outputs. In this case, the COM pin shouldn't be used.

- External Regulator

An external 3-terminal regulator can be connected to the output of the converter to achieve full regulation. Make sure the converter's output voltage provides sufficient head room for the regulator. An additional benefit is that the built-in protection features in the regulator, such as OCP, OTP, etc, will protect the converter also. In a complimentary supply, a negative output regulator must be used to achieve the negative regulated output.